

YE-MT20
EUROPE
2020/2021



CUTTING TOOLS













MILLING

 YG-1 CO., LTD.











MILLING TOOLS

1. ENGLISH 2.GERMAN 3.FRENCH 4. ITALIAN 5. SPANISH 6. RUSSIAN 7. POLISH 8. TURKISH

PRODUCTS	DESCRIPTION	PAGE
 <p>1 CBN END MILLS 2 CBN - FRÄSER 3 FRAISE CBN 4 FRESE CBN 5 Fresas CBN 6 Концевые фрезы CBN из кубического нитрида бора 7 FREZY CBN 8 CBN PARMAC FREZELER</p>	<p>CBN(Cubic Boron Nitride) Machining High Hardened Steels up to HRc70 Mirror Finish</p>	049
 <p>1 i-Xmills, CARBIDE INSERT END MILLS 2 i-Xmills, HM-WP - FRÄSER 3 i-Xmills, PLAQUETTES CARBURE 4 INSERTI i-XMILLS 5 i-Xmills, insertos metal duro para copiado 6 Фрезы i-Xmills с твердосплавными сменными пластинами 7 PŁYTKI WĘGLIKOWE i-Xmills 8 i-Xmills, DEĞİŞTİRİLEBİLİR KARBÜR UÇLU PARMAC FREZE</p>	<p>Various Applications Type of Inserts Available for General Steels, Pre-Hardened Steels, High Hardened Steels, Stainless Steels and Graphite</p>	055
 <p>1 i-SMART, CARBIDE MODULAR HEAD END MILLS 2 i-Smart, Schaffräser mit auswechselbaren VHM Schneidköpfen 3 i-SMART, PLAQUETTE CARBURE DE FRAISAGE 4 TESTINE MODULARI IN MD i-SMART 5 i-SMART, Sistema de fresado modular 6 Концевые фрезы i-SMART модульного типа 7 Frezy i-SMART na wymienne płytki węglkowe 8 i-SMART - MODULER KARBÜR UÇLU PARMAC FREZE</p>	<p>For General Steels, Hardened Steels and Cast Iron</p>	081
 <p>1 X5070 NANO SOLID CARBIDE END MILLS 2 X5070 NANO-VHM - FRÄSER 3 X5070 - FRAISE CARBURE NG 4 FRESE X-5070 5 X5070, fresas de metal duro nanograno 6 Концевые фрезы X5070 из нано-зернистого твердого сплава 7 FREZY NANO WĘGLIKOWE X5070 8 X5070 NANO SOLID KARBÜR PARMAC FREZELER</p>	<p>For High Hardened Steels (HRc45 to HRc70) High Speed Machining and Dry Cutting</p>	101
 <p>1 4G Mill SOLID CARBIDE END MILLS 2 4G Mill VHM - FRÄSER 3 4G Mill - FRAISE CARBURE 4 FRESE 4G MILL 5 Fresas de metal duro 4G Mill 6 Твердосплавные концевые фрезы 4G Mill 7 FREZY WĘGLIKOWE 4G 8 4G MILL SOLID KARBÜR PARMAC FREZELER</p>	<p>High Speed Cutting for Pre-Hardened Steels up to HRc55</p>	161
 <p>1 X-POWER PRO SOLID CARBIDE END MILLS 2 X-POWER PRO VHM - FRÄSER 3 X-POWER PRO - FRAISE CARBURE 4 FRESE X-POWER PRO 5 Fresas de metal duro X-Power 6 Твердосплавные концевые фрезы X-POWER PRO 7 FREZY WĘGLIKOWE X-POWER PRO 8 X-POWER PRO SOLID KARBÜR PARMAC FREZELER</p>	<p>For Pre-Hardened Steels up to HRc55</p>	347
 <p>1 TitaNox-POWER SOLID CARBIDE END MILLS 2 TitaNox-Power VHM Schaffräser 3 TitaNox-POWER, FRAISES CARBURE MONOBLOC 4 FRESE TITANOX - POWER 5 TitaNox- Power, Fresas de metal duro 6 Твердосплавные концевые фрезы TitaNox для обработки титана, инконеля и нержавеющей стали 7 Frezy węglkowe TitaNox-POWER 8 TITANOX-POWER SOLID KARBÜR PARMAC FREZELER</p>	<p>High Speed Machining for Exotic Materials: Titanium, Inconel and Stainless Steels</p>	395
 <p>1 JET-POWER SOLID CARBIDE & HSS-PM END MILLS 2 JET - POWER VHM - FRÄSER 3 JET-POWER - FRAISE CARBURE 4 FRESE JET-POWER 5 Fresas de metal duro Jet-Power 6 Фрезы JET-POWER из твердого сплава и порошковой быстрорежущей стали 7 FREZY WĘGLIKOWE I HSS-PM JET POWER 8 JET-POWER SOLID KARBÜR ve HSS-PM PARMAC FREZELER</p>	<p>For Exotic materials like Stainless Steels, Nickel Alloys and Titanium</p>	411
 <p>1 V7 PLUS SOLID CARBIDE END MILLS 2 V7 Plus VHM CPH Schaffräser 3 V7 PLUS, FRAISES CARBURE MONOBLOC 4 FRESE V7 PLUS 5 V7 Plus, fresas de metal duro 6 Концевые фрезы V7 PLUS из твердого сплава 7 Frezy węglkowe V7 Plus 8 V7 PLUS- SOLID KARBÜR PARMAC FREZELER</p>	<p>High Performance Carbide End Mills for Steels, Cast Iron and Stainless Steels</p>	439
 <p>1 ALU-POWER HPC SOLID CARBIDE END MILLS 2 Alu Power HPC VHM Fräser 3 ALU-POWER HPC - FRAISE CARBURE 4 FRESE ALU-POWER HPC 5 ALUPOWER HPC FRESAS DE METAL DURO 6 Концевые фрезы ALU-POWER HPC для обработки алюминиевых сплавов и цветных металлов 7 FREZY WĘGLIKOWE ALU-POWER HPC 8 ALU-POWER HPC SOLID KARBÜR PARMAC FREZELER</p>	<p>For Aluminium, Aluminum Die Cast, Non-ferrous Alloys and Plastics</p>	463

MILLING TOOLS

1. ENGLISH 2.GERMAN 3.FRENCH 4. ITALIAN 5. SPANISH 6. RUSSIAN 7. POLISH 8. TURKISH

	PRODUCTS	DESCRIPTION	PAGE
	1 ALU-POWER SOLID CARBIDE & HSS-PM END MILLS 2 ALU - POWER VHM - FRÄSER 3 ALU-POWER - FRAISE CARBURE 4 FRESE ALU-POWER 5 Fresas de metal duro Alu-Power y HSS-PM 6 6. Фрезы ALU-POWER из твердого сплава и порошковой быстрорежущей стали 7 FREZY WEGLIKOWE I HSS-PM ALU-POWER 8 ALU-POWER SOLID KARBÜR ve HSS-PM PARMAK FREZELER	For Aluminium Alloys and Silent Cutting	477
	1 D-POWER GRAPHITE SOLID CARBIDE END MILLS 2 D - POWER Graphit VHM - FRÄSER 3 D-POWER graphite - FRAISE CARBURE 4 FRESE D-POWER GRAFITE 5 Fresas de metal duro D-Power grafito 6 6. Твердосплавные концевые фрезы D-POWER для Графита (с алмазным покрытием) 7 FREZY WEGLIKOWE D-POWER GRAPHITE 8 D-POWER GRAFIT SOLID KARBÜR FREZELER	For Graphites	499
	1 D-POWER CFRP SOLID CARBIDE END MILLS 2 D - POWER CFK VHM - FRÄSER 3 D-POWER CFRP - FRAISE CARBURE 4 FRESE A CANDELA IN MDI D-POWER CFRP 5 Fresas de metal duro D-Power CFRP 6 6. Твердосплавные фрезы D-POWER для Углепластика (с алмазным покрытием) для обработки композитных материалов. 7 FREZY WEGLIKOWE D-POWER CFRP 8 D-POWER CFRP SOLID KARBÜR PARMAK FREZELER	For Composite Materials including CFRP and GFRP	519
	1 SOLID CARBIDE ROUTERS 2 Mikroverzahnter VHM Fräser 3 FRAISE A DETOURER 4 fresa in metallo duro 5 Fresas de metal duro para composite 6 6. Твердосплавные роутеры (с алмазным покрытием) 7 FREZY WEGLIKOWE ROUTER 8 SOLID KARBÜR KALIPÇI ROUTER FREZELER	For Composite Materials including CFRP and GFRP	525
	1 CRX S SOLID CARBIDE END MILLS 2 CRX S VHM - FRÄSER 3 CRX S - FRAISE CARBURE 4 FRESE CRX S 5 Fresas de metal duro CRX S 6 6. Твердосплавные концевые фрезы CRX S 7 FREZY WEGLIKOWE CRX S 8 CRX S SOLID KARBÜR PARMAK FREZELER	DLC Coated End Mills for Copper	529
	1 K-2 SOLID CARBIDE END MILLS 2 K-2 VHM - FRÄSER 3 K-2 - FRAISE CARBURE 4 FRESE K-2 5 Fresas de metal duro K-2 6 6. Твердосплавные концевые фрезы K2 7 FREZY WEGLIKOWE K-2 8 K-2 SOLID KARBÜR PARMAK FREZELER	General Purpose Conventional or High Speed Milling Wet or Dry Cutting	541
	1 ONLY ONE COATED PM60 END MILLS 2 Only One, beschichtete Pulvermetall PM60 Schaftfräser 3 ONLY ONE, FRAISES PM60 REVÊTUES 4 FRESE ONLY ONE IN PM60, RIVESTITE 5 Only One, Cortador de PM60 con recubrimiento 6 Концевые фрезы ONLY ONE из быстрорежущей стали PM60, с покрытием 7 Pokrywane frezy PM60 z serii ONLY ONE 8 ONLY ONE KAPLAMALI HSS-PM60 FREZELER	Perfect Solution of Carbide Chipping under Vibrations	615
	1 TANK-POWER HSS-PM END MILLS 2 TANK - POWER HSS-PM - FRÄSER 3 TANK-POWER - FRAISES HSS-PM 4 FRESE TANK-POWER IN HSS-PM 5 Fresas HSS-PM Tank-Power 6 Концевые фрезы TANK-POWER из порошковой быстрорежущей стали 7 FREZY HSS-PM TANK-POWER 8 TANK-POWER HSS-PM PARMAK FREZELER	High Toughness for Stainless Steels, Carbon steels and Alloy Steels for General Application, Roughing & Finishing	637
	1 GENERAL HSS END MILLS 2 HSS SCHAFTFRÄSER 3 FRAISES HSS 4 FRESE IN HSS 5 Fresas HSS 6 Концевые фрезы общего применения из быстрорежущей стали 7 FREZY Z HSS 8 GENEL KULLANIM HSS PARMAK FREZELER	General Purpose Coating Available	671
	1 HSS MILLING CUTTERS 2 HSS FRÄSER 3 FRAISES DE FORME HSS 4 CORPI FRESA IN HSS 5 Fresas HSS 6 Фрезы из быстрорежущей стали специального применения 7 FREZY Z HSS 8 HSS FREZE KAFALARI	General Works. Available Dovetail, Woodruff Keyseat, T-slot, Side Milling Cutters and HSS(8% Cobalt) Corner Rounding, Shell End Mills	789

CBN End mills

Reference page : p.48 ~ p.53

TEST I Total Milling Length : 240mm

Surface Roughness of Work Piece

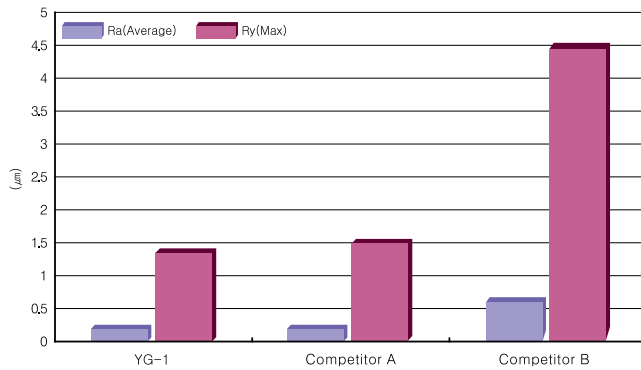

Cutting Condition (Ø1 x R0.5)

Tool	2Flute, CBN Ball Nose End mill
Size	Ø1xØ4x0.6x50
Work Material	JIS : SKD11(HRc60) DIN : X155CrV-Mo12-1 WR : 1.2379
Vc(m/min)	94.25
RPM (rev./min)	30,000
Feed(mm/min)	1,500
Milling Depth(mm)	0.01
Coolant	Oil Mist
Machine	Machining Center

Maximum Wear (μm)

YG CBN (19.611μm)

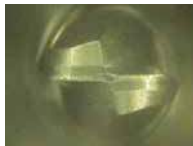

Competitor A (32.249μm)

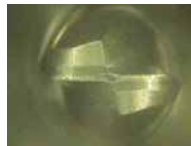

Competitor B

Tool was broken after 100 meter milling

TEST II Total Milling Length : 750mm

Surface Roughness of Work Piece

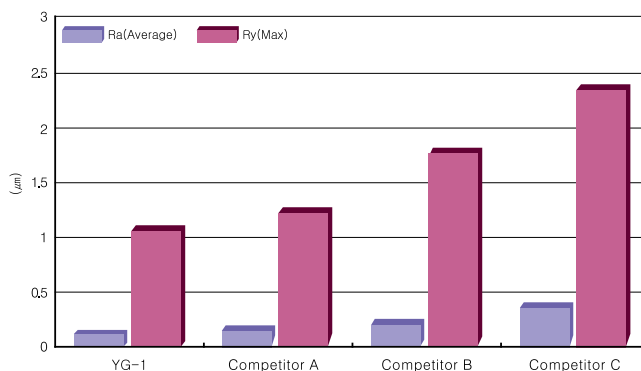

Cutting Condition (Ø2 x R1.0)

Tool	2Flute, CBN Ball Nose End mill
Size	Ø2xØ4x1.8x50
Work Material	JIS : SKD11(HRc60) DIN : X155CrV-Mo12-1 WR : 1.2379
Vc(m/min)	188.50
RPM (rev./min)	30,000
Feed(mm/min)	2,000
Milling Depth(mm)	0.01
Coolant	Oil Mist
Machine	Machining Center

Maximum Wear (μm)

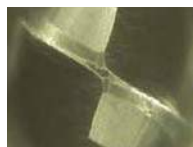

YG CBN
(57.630μm)

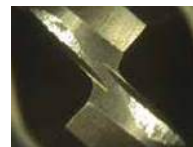

Competitor A
(100.314μm)

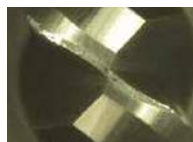

Competitor B
(71.471μm)



Competitor C
(170.200μm)

i-Xmill End mills

Reference page : p.55 ~ p.79

TEST I *i-Xmill* Ball Nose

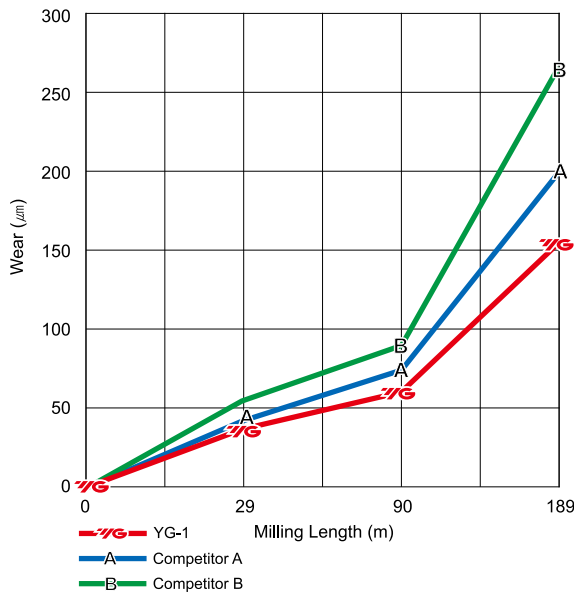

YG i-Xmill

Total Milling Length : 189m



Competitor A

Total Milling Length : 189m



Competitor B

Total Milling Length : 189m

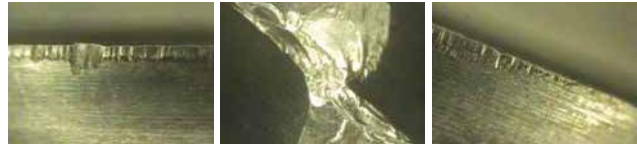

Cutting Condition (Side Cutting)

Tool	i-Xmill Ball (XMB120C160)	Vc(m/min)	80.42	Milling Depth(mm)	Axial : 0.8 mm / Radial : 1.6 mm
Size	Ø16xR8.0	RPM (rev./min)	1,600	Coolant	Oil Mist
Work Material	JIS : SKD61 (HRC50), DIN : X40GrMoV51(1.2344) AISI : H13	Feed(mm/min)	390	Overhang	YG-1, Competitor B : 48 / Competitor A : 56
		Feed per tooth(mm/tooth)	0.12	Machine	Machining Center

TEST II *i-Xmill* Corner Radius

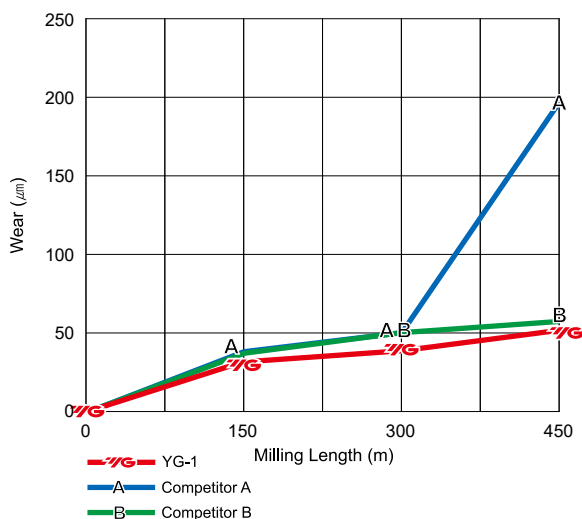

YG i-Xmill

Total Milling Length : 450m



Competitor A

Total Milling Length : 450m



Competitor B

Total Milling Length : 450m



Cutting Condition (Side Cutting)

Tool	i-Xmill Corner Radius (XMR110A16020)	Vc(m/min)	280	Milling Depth(mm)	Axial : 3.0 / Radial : 0.2
Size	Ø16xR2.0	RPM (rev./min)	5,570	Coolant	Oil Mist
Work Material	KS : KP4M (Mold steels HRC35) DIN : 40CrMnNiMo8-6-4(1.2738) AISI : P20+Ni	Feed(mm/min)	2,230	Overhang(mm)	70
		Feed per tooth(mm/tooth)	0.2	Machine	Machining Center

TEST III *i-Xmill* with Diamond Coating

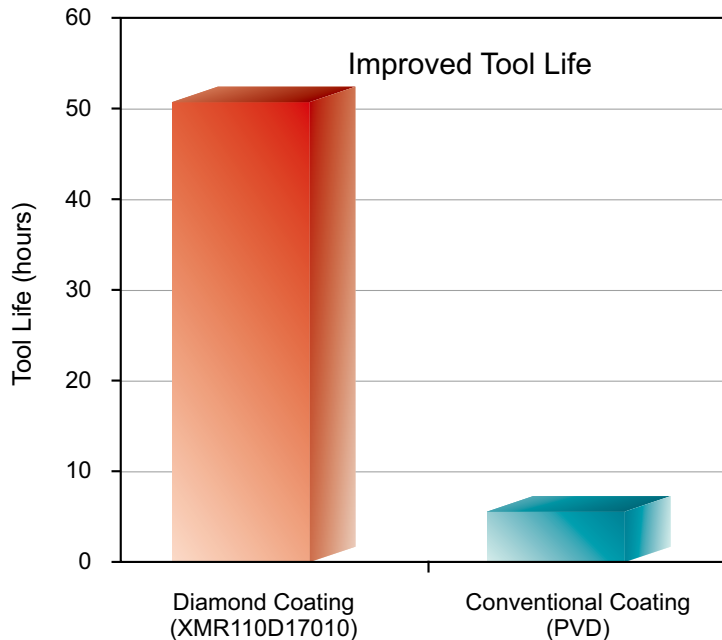

Cutting Condition

Tool	i-Xmill Corner Radius (XMR110D17010)
Size	Ø17 x R1.0
Work Material	Graphite
Vc(m/min)	320
RPM (rev./min)	6,000
Feed(mm/min)	2,800
Feed per tooth(mm/tooth)	0.23
Milling Depth(mm)	Axial : 0.2
Coolant	Air

Coating properties

This coating generation features a good crystalline structure. It protects tools perfectly against abrasive wear and is unsurpassed in graphite cutting.

Feature

1. High Abrasive wear resistance.
2. Good Coefficient of friction.(against Al)
3. High Precision.

Advantages

Diamond coated i-Xmill possible to cut graphite workpieces with substantially greater speeds and in significantly better quality.

Applications

1. Precision-structured graphite electrodes.
2. Micro-Electromechanical Systems. (MEMS)
3. Printed Circuit Boards. (PCBs)
4. Ceramics (greens, sintered) Dental, machinery.

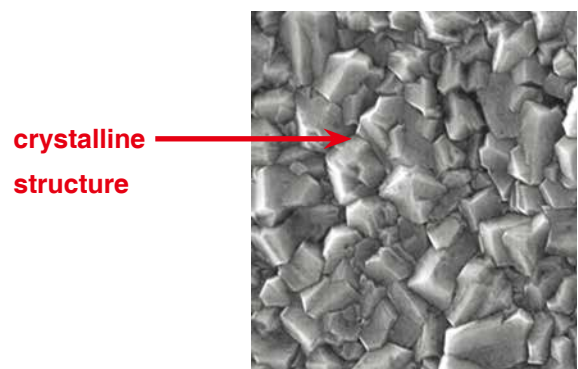
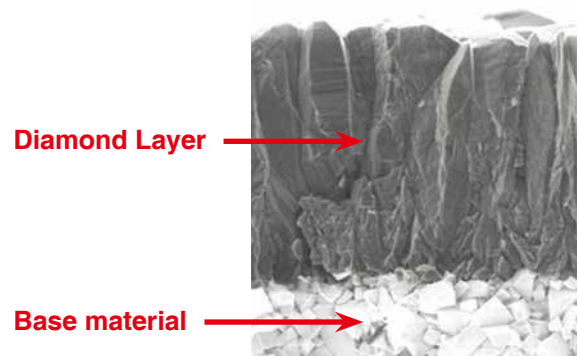

i-SMART Modular Type End mills

Reference page : p.81 ~ p.99

TEST Total Milling Length : 60m

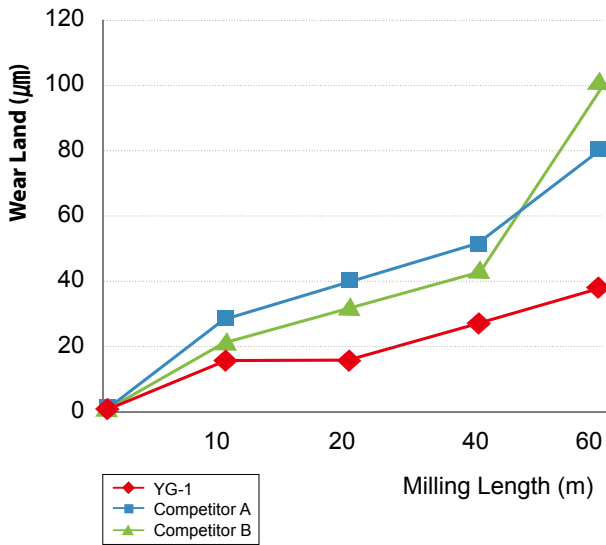

Cutting Condition (Down & Side Cutting)

Tool	4Flute Corner Radius
Size	Ø16 x R1.0
Work Material	KP4M (HRC35) AISI P20+Ni DIN 1.2738 Improved
Vc(m/min)	155.82
RPM (rev./min)	3,100
Feed(mm/min)	280
Feed per tooth(mm/tooth)	0.02
Milling Depth(mm)	Axial : 12 / Radial : 0.8
Overhang(mm)	77
Coolant	Wet Cut
Machine	Machining Center

YG i-SMART



Competitor A

D



Competitor B



X5070 End mills

Reference page : p.101 ~ p.159

TEST I Carbide 6 Flute 45° Helix End mill for Hardened Steel

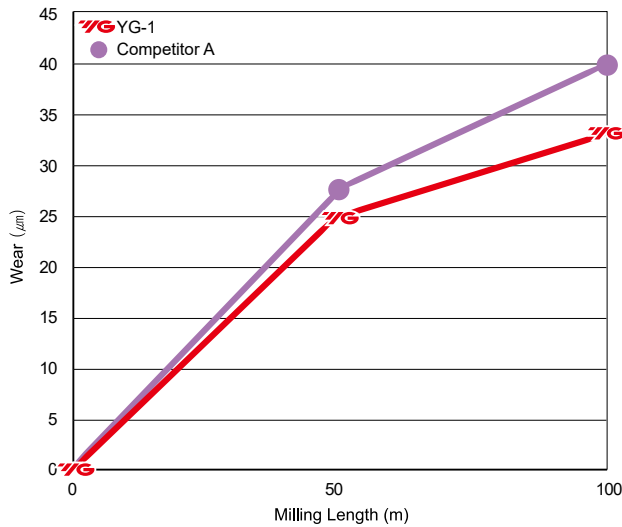

Cutting Condition (Down & Side Cutting)

Tool	6Flute 45° Helix
Size	Ø16×Ø16×40×110
Work Material	JIS : SKD61(HRc50) DIN : X40CrMoV5-1(1.2344) AISI : H13
Vc(m/min)	96.5
RPM (rev./min)	1,920
Feed(mm/min)	912
Milling Depth(mm)	Axial : 24 / Radial : 0.96
Coolant	Dry Cut
Overhang(mm)	52
Machine	Machining Center



YG-1 X5070

(Total Milling Length : 100m)



Competitor A

(Total Milling Length : 100m)

TEST II Carbide 4 Flute Center match Ball Nose End mill for Hardened Steel

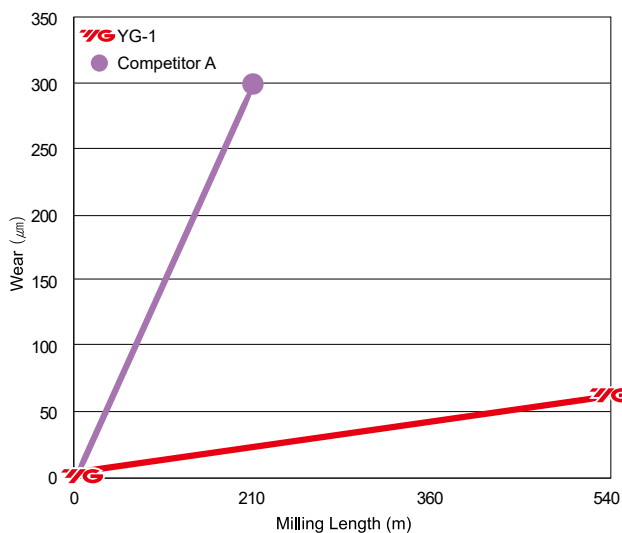

Cutting Condition (Side Cutting)

Tool	4Flute Ball Nose
Size	Ø10×Ø10×18×100
Work Material	JIS : SKD11(HRc60) DIN : X155CrVMo12-1(1.2379) AISI : D2
Vc(m/min)	210.486
RPM (rev./min)	6,700
Feed(mm/min)	2,800
Milling Depth(mm)	Axial : 0.2 / Radial : 0.5
Coolant	Oil Mist
Overhang(mm)	32
Machine	Machining Center



YG-1 X5070

(Total Milling Length : 540m)

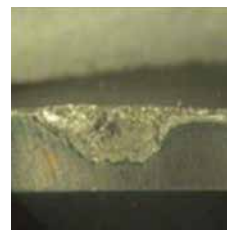

Competitor A

(Total Milling Length : 210m)

4G Mills End mills

Reference page : p.161 ~ p.345

TEST I - Ball Nose

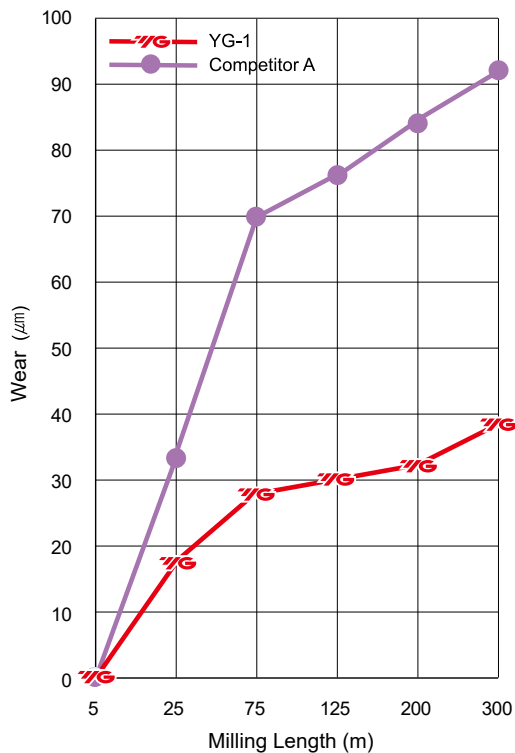

YG 4G Mills

Total Milling Length : 300m

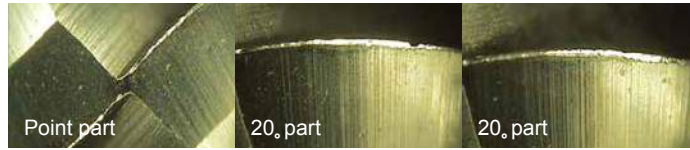

Competitor A

Total Milling Length : 300m

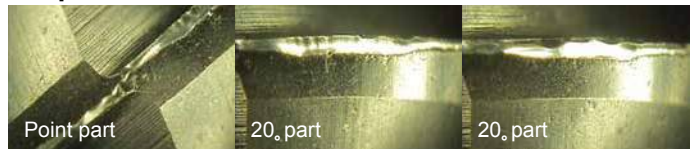

Cutting Condition (Profile Cutting)

Tool	2Flute, SEMD98060E
Size	Ø6×6×12×90
Work Material	KP4M (HRC35 / DIN 1.2738 Improved)
Vc(m/min)	130.061
RPM (rev./min)	6,900
Feed(mm/min)	830
Feed per tooth(mm/tooth)	0.060
Milling Depth(mm)	Axial : 0.2 / Radial : 1.2
Coolant	Oil Mist
Overhang(mm)	26
Machine	Machining Center

TEST II - Corner Radius

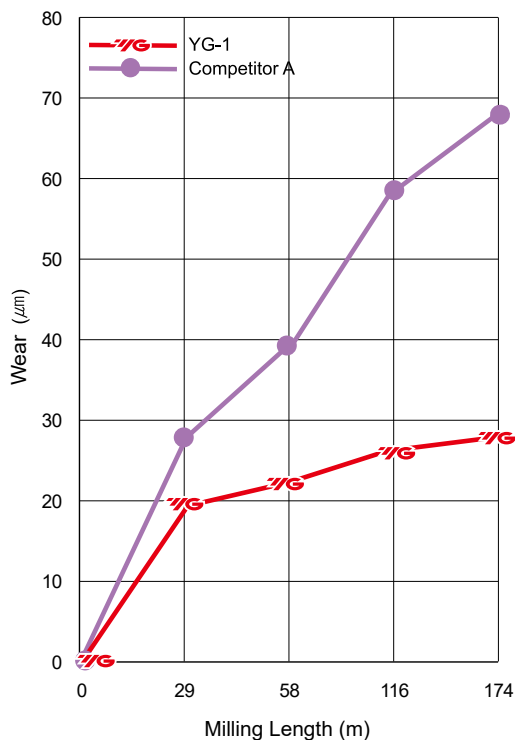

YG 4G Mills

Total Milling Length : 174m

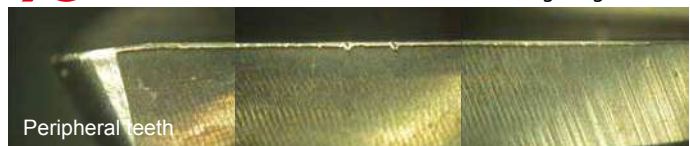

Competitor A

Total Milling Length : 174m

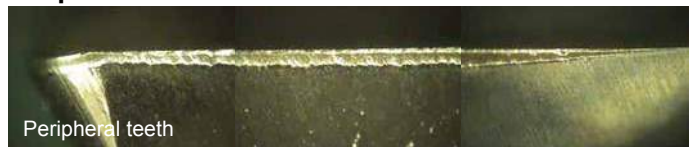

Cutting Condition (Down & Side Cutting)

Tool	4Flute, SEME0110005E
Size	Ø10(R0.5)×10×25×100
Work Material	KP4M (HRC35 / DIN 1.2738 Improved)
Vc(m/min)	51.522
RPM (rev./min)	1,640
Feed(mm/min)	180
Feed per tooth(mm/tooth)	0.027
Milling Depth(mm)	Axial : 25 / Radial : 0.5
Coolant	Oil Mist
Overhang(mm)	41
Machine	Machining Center

TEST I 4 Flute Multiple Helix

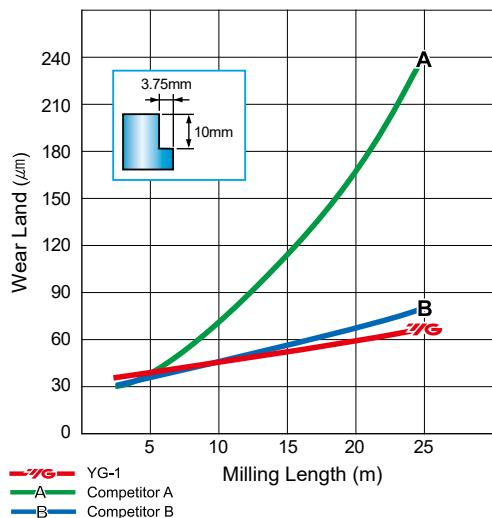

YG X-SPEED ROUGHER

Total Milling Length : 25m

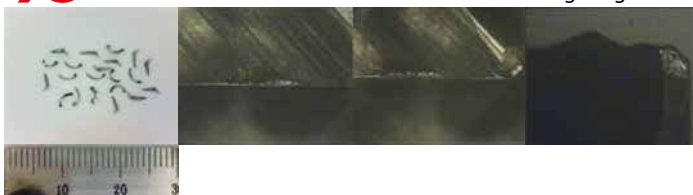

Competitor A

Total Milling Length : 25m



Competitor B

Total Milling Length : 25m



Cutting Condition (Down & Side Cutting)

Size	X-SPEED ROUGHER	Ø10×10×15×72
	Competitor A	Ø10×10×20×72
	Competitor B	Ø10×10×15×80
Work Material	DIN : X40CrMoV51 (1.2344) JIS : SKD61 (HRC30) AISI : H13	

RPM (rev./min)	5,000 (157.08 m/min)
Feed(mm/min)	1,300
Coolant	Wet Cut
Overhang(mm)	32
Machine	Machining Center

TEST II 4 Flute Multiple Helix

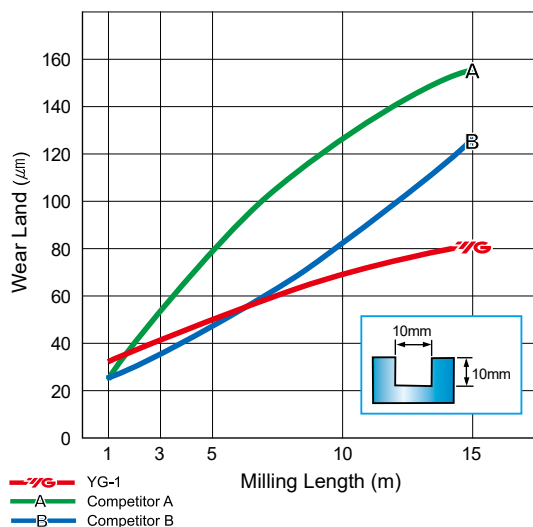

YG X-SPEED ROUGHER

Total Milling Length : 15m

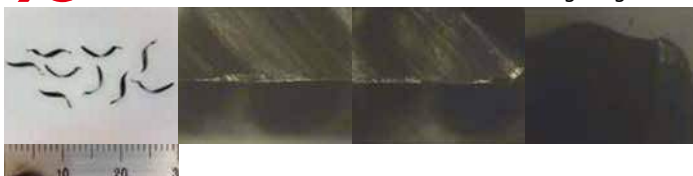

COMPETITOR A

Total Milling Length : 15m

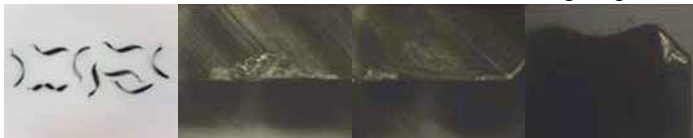

COMPETITOR B

Total Milling Length : 15m



Cutting Condition (Slotting)

Size	X-SPEED ROUGHER	Ø10×10×15×72
	Competitor A	Ø10×10×20×72
	Competitor B	Ø10×10×15×80
Work Material	DIN : X40CrMoV51 (1.2344) JIS : SKD61 (HRC30) AISI : H13	

RPM (rev./min)	4,000 (125.66 m/min)
Feed(mm/min)	1,000
Coolant	Wet Cut
Overhang(mm)	32
Machine	Machining Center

X-POWER PRO End mills

Reference page : p.347 ~ p.394

TEST I 2 Flute Square End mills

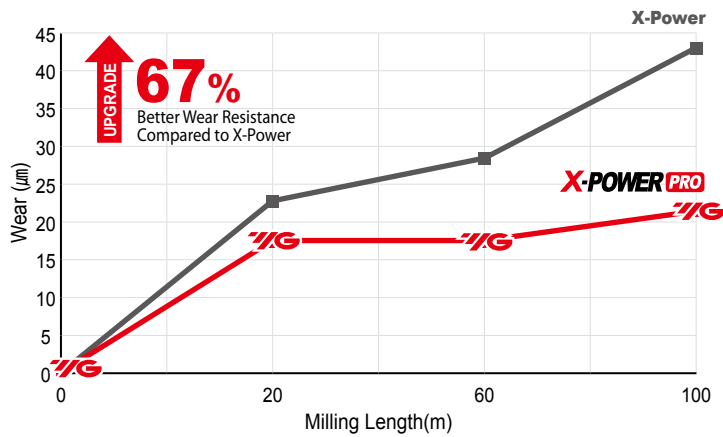

X-POWER PRO

Milling length : 100m



X-Power

Milling length : 100m



Cutting Condition (Down & Side Cutting)

Tool	X-POWER PRO	X-Power
Milling Length(m)	100	
Size	Ø10.0xØ10.0x22x70	
Material	KP4M(HRc35) / DIN 1.2311, ANSI P20+Ni	
Vc(m/min)	63	
Feed(mm/min)	300	
Milling Depth(mm)	Ap:10, Ae:0.5	
Coolant	Oil Mist	

TEST II 2 Flute Ball End mills

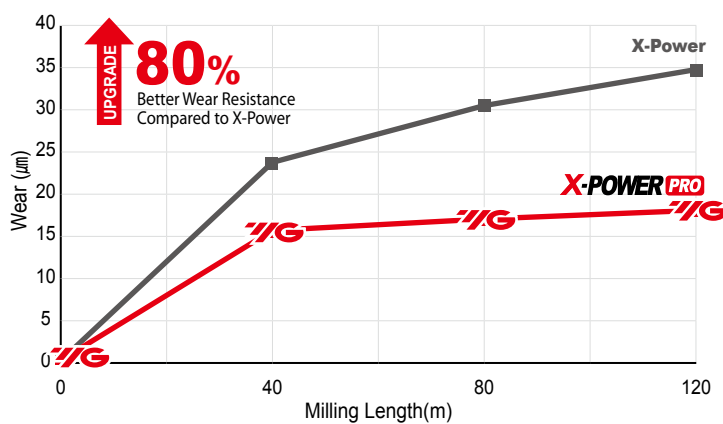

X-POWER PRO

Milling length : 120m



X-Power

Milling length : 120m



Cutting Condition (Profile Cutting)

Tool	X-POWER PRO	X-Power
Milling Length(m)	120	
Size	Ø6.0xØ6.0x12x90	
Material	KP4M(HRc35) / DIN 1.2311, ANSI P20+Ni	
Vc(m/min)	130	
Feed(mm/min)	830	
Milling Depth(mm)	Ap:0.2, Ae:1.2	
Coolant	Oil Mist	

TEST III 4 Flute Corner Radius End mills

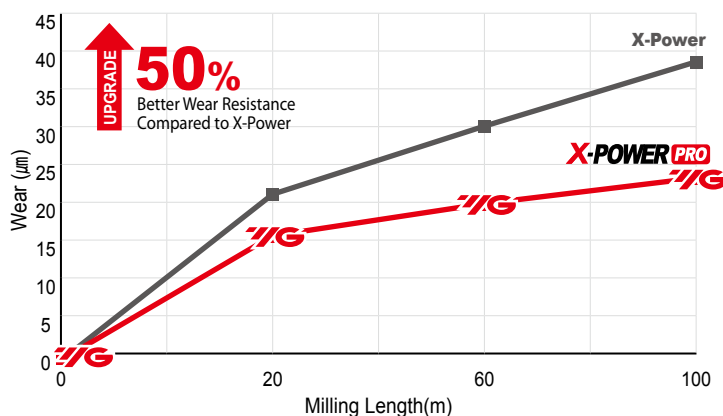

X-POWER PRO

Milling length : 100m



X-Power

Milling length : 100m



Cutting Condition (Down & Side Cutting)

Tool	X-POWER PRO	X-Power
Milling Length(m)	100	
Size	Ø10.0(R0.5) x Ø10.0 x 30 x 90	
Material	KP4M(HRc35) / DIN 1.2311, ANSI P20+Ni	
Vc(m/min)	52	
Feed(mm/min)	180	
Milling Depth(mm)	Ap : 25, Ae : 0.5	
Coolant	Oil Mist	

TEST I Y-Coated Solid Carbide 4 Flutes with Double Core End mills

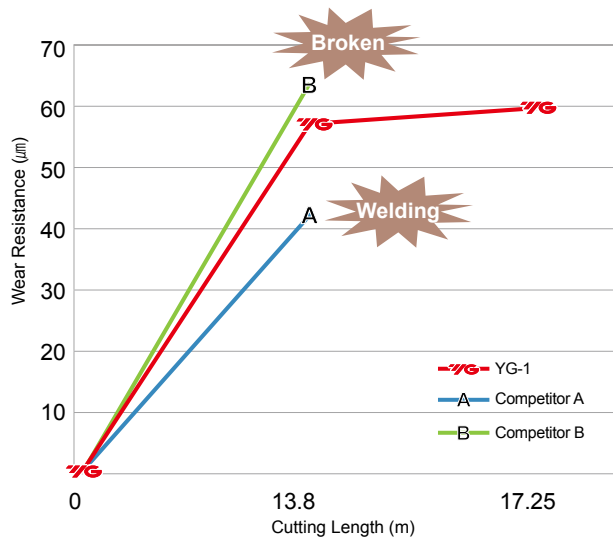

Cutting Condition (Slotting)

Tool	4Flute, with Double Core
Size	Ø12(R1) x Ø12 x 26 x 80
Work Material	DIN : TiAV6V4 (Titanium)
Cutting Depth(mm)	12 (Axial Depth)
RPM (rev./min)	1,591

Feed(mm/min)	254
Feed per tooth(mm/tooth)	0.027
Coolant	Wet Cut
Overhang(mm)	36
Machine	Machining Center

TEST II Y-Coated Solid Carbide 5 Flutes End Mills

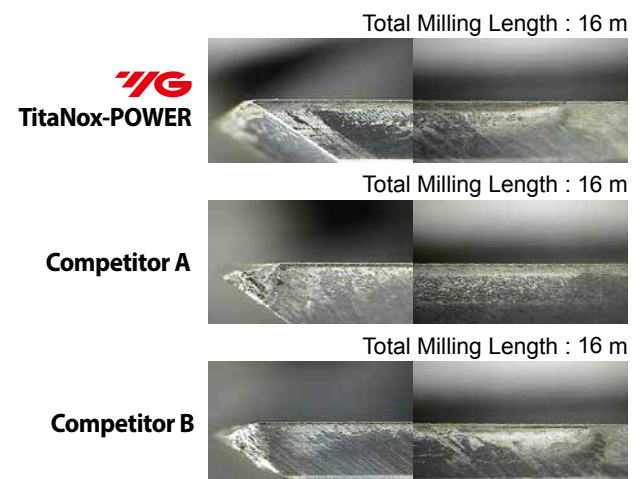
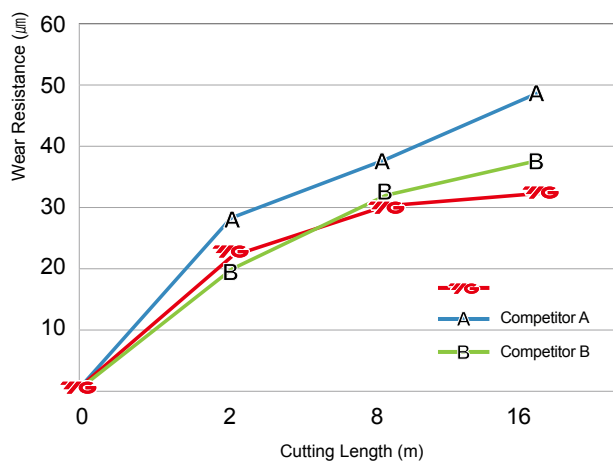

Cutting Condition (Down & Side Cutting)

Tool	5Flute
Size	Ø12 x Ø12 x 26 x 83
Work Material	DIN : TiAV6V4 (Titanium)
RPM (rev./min)	1,591

Feed(mm/min)	398
Milling Depth(mm)	Axial : 18 / Radial : 3.6
Coolant	Wet Cut
Machine	Machining Center

V7 PLUS End mills

Reference page : p.439 ~ p.461

TEST I 4 Flute

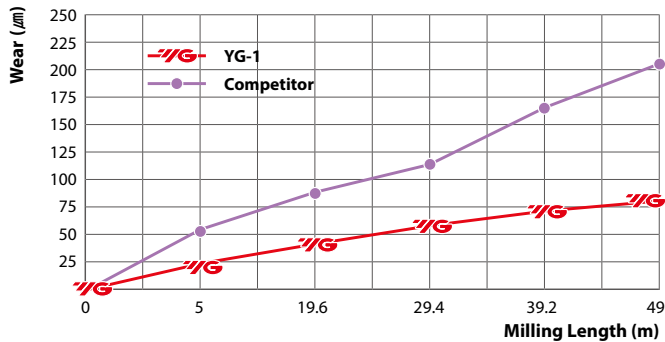

YG-1 V7 PLUS

Total Milling Length : 49m



Competitor

Total Milling Length : 49m



Cutting Condition (Side Cutting)

Tool	V7 Plus	4Flute
Size	Ø10 x Ø10 x 22 x 72	
Work Material	- JIS : S45C(HRc30) - DIN : C45 - WR : 1.0503	
Vc(m/min)	230.09	
RPM (rev./min)	7,324	
Feed(mm/min)	1,464	
Feed per tooth(mm/tooth)	0.05	
Milling Depth(mm)	Axial : 10 / Radial : 3	
Coolant	Wet Cut	
Overhang(mm)	34	
Machine	Machining Center	

TEST II 6 Flute

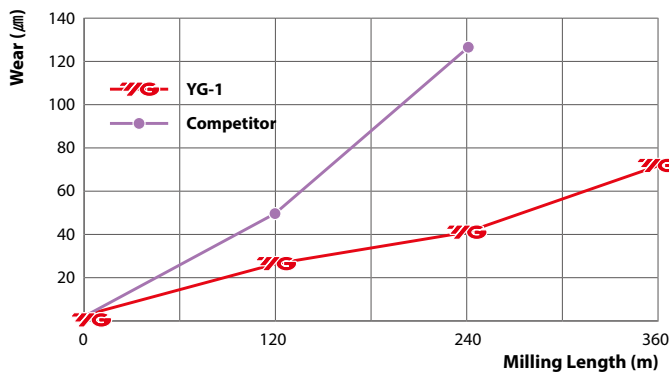

YG-1 V7 PLUS

Total Milling Length : 360m



Competitor

Total Milling Length : 300m

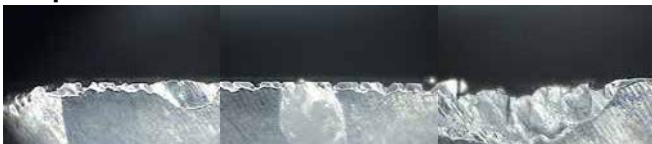

Cutting Condition (Trochoidal Cutting)

Tool	V7 Plus	6Flute
Size	Ø12(R1) x Ø12 x 26 x 83	
Work Material	JIS : S45C(HRc30) DIN : C45 WR : 1.0503	
Vc(m/min)	278.67	
RPM (rev./min)	7,392	
Feed(mm/min)	7,495	
Feed per tooth(mm/tooth)	0.17	
Milling Depth(mm)	Axial: 24(2D), Radial: 0.6(0.05D)	
Coolant	Wet Cut	
Overhang(mm)	36	
Machine	Machining Center	

The Goal: Reduce cycle time by at least 25%.

The Test:

Three YG-1 3-flute ALU-POWER HPC End mills are pitted against two strong competitors using similar configurations for milling aluminum alloy.

Material	7075 T-6 (Ribs)	
Machine	5-axis horizontal machining center	
Coolant	High pressure	
Tool Holder	Shrink fit Haimer	
Speed (mm)	RPM	V _c (SMM)
25mm tool	33,000	2,594
20mm tool	30,000	1,886
16mm tool	26,000	1,308
Speed (in.)	RPM	SFM
.9843 in. tool	33,000	8,510
.7874 in. tool	30,000	6,189
.6299 in. tool	26,000	4,291
Feed (mm)	m/min	mm/rev
25mm tool	20	.6071
20mm tool	24.5	.8179
16mm tool	11.4	.4420
Feed (in.)	in./min	in./rev
.9843 in. tool	787.4	.0239
.7874 in. tool	964.565	.0322
.6299 in. tool	452.755	.0174
Step (mm)	0.5 – 18	
Step (in.)	.01968 – .7087	
Axial (mm)	13	
Axial (in.)	.5118	
Competitor	U.S. Manufacturer and UK Manufacturer	
YG-1 Tools	3 ALU-POWER HPC Tools	
Fixture	Screws & Vacuum	

The Results:

Saved up to \$2 million by improving the process by 27%.

The combination of advanced geometry and the superior coating of the YG-1 3-Flute ALU-POWER HPC End mills beat both competitors in:

- ▶ Trochoidal machining
- ▶ Peel milling
- ▶ Cutter path performance

These process improvements resulted in a savings of seven minutes per part. The process was rolled out to all machines in the company.

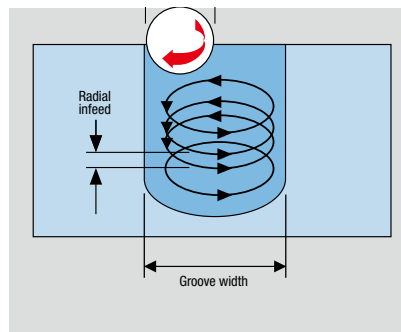

▲ In trochoidal milling applications, the cutter follows a spiral path by moving radially as it rotates providing faster machining times, lower tooling costs and reduced loads on machine components.

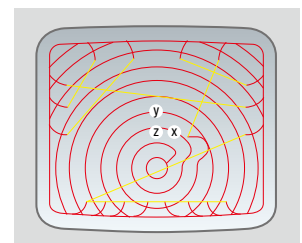

▲ Outstanding chip evacuation through deep gullet design coupled with high speed milling leaves a well-defined clean cutter path.

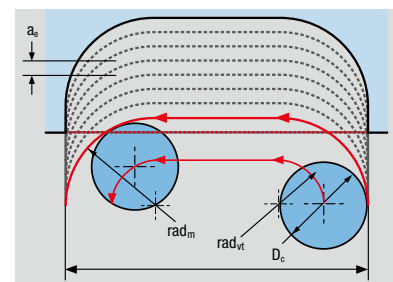

◀ Peel milling applications benefit from ALU-POWER HPC's super sharp high-speed milling ability.



ONLY ONE Coated PM60 End Mills

Reference page : p.615 ~ p.635

TEST I 4 Flute Square End mill

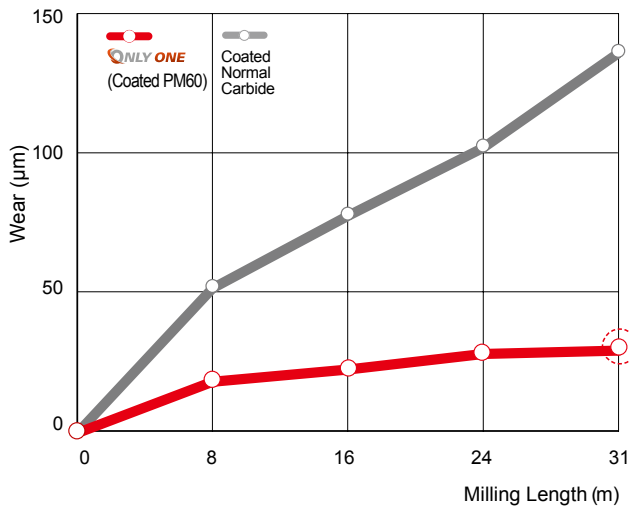

Cutting Condition (Down & Side Cutting)

Tool	Only One Coated PM60	Coated Normal Carbide
Size	Ø10xØ10x22x72/Ø10xØ10x22x70	
Work Material	JIS : S45C KS : SM45C DIN : C45 AISI : 1045	
RPM (rev./min)	2,750	
Feed(mm/min)	520	
Milling Method(mm)	Axial : 3 / Radial : 1	
Coolant	Wet Cut	
Machine	Machining Center	

ONLY ONE Coated PM60



Coated Normal Carbide



TEST II 4 Flute Square End mill

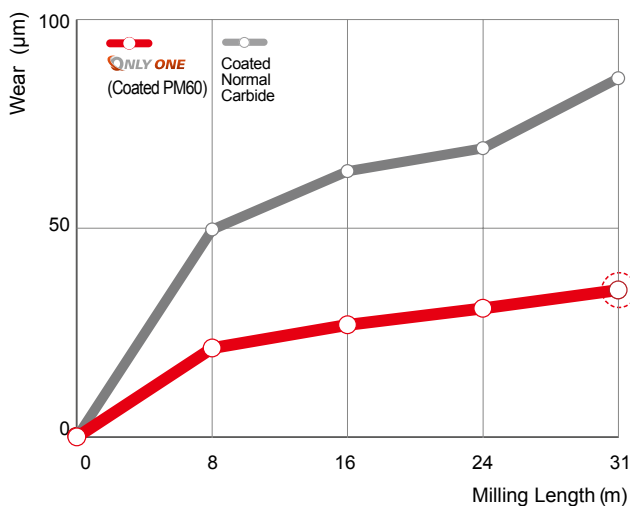

Cutting Condition (Down & Side Cutting)

Tool	Only One Coated PM60	Coated Normal Carbide
Size	Ø10xØ10x22x72/Ø10xØ10x22x70	
Work Material	JIS : S45C KS : SM45C DIN : C45 AISI : 1045	
RPM (rev./min)	2,750	
Feed(mm/min)	520	
Milling Method(mm)	Axial : 10 / Radial : 1	
Coolant	Wet Cut	
Machine	Machining Center	

ONLY ONE Coated PM60



Coated Normal Carbide





Global Cutting Tool Leader **YG-1**



MILLING

MILLING TOOLS

CBN END MILLS

i-Xmill END MILLS

i-SMART END MILLS

X5070 NANO SOLID CARBIDE END MILLS

4G Mill SOLID CARBIDE END MILLS

X-POWER PRO SOLID CARBIDE END MILLS

TitaNox-POWER SOLID CARBIDE END MILLS

JET-POWER SOLID CARBIDE & HSS-PM END MILLS

V7 PLUS SOLID CARBIDE END MILLS

ALU-POWER HPC SOLID CARBIDE END MILLS

ALU-POWER SOLID CARBIDE & HSS-PM END MILLS

D-POWER GRAPHITE SOLID CARBIDE END MILLS (DIAMOND COATED)

D-POWER CFRP SOLID CARBIDE END MILLS (DIAMOND COATED)

SOLID CARBIDE ROUTERS (DIAMOND COATED)

CRX S SOLID CARBIDE END MILLS

K-2 SOLID CARBIDE END MILLS

ONLY ONE COATED PM60 END MILLS

TANK-POWER HSS-PM END MILLS

GENERAL HSS (8% Cobalt) END MILLS

HSS-E MILLING CUTTERS

TECHNICAL DATA

CONTENTS

CBN END MILLS

CARBIDE EXCHANGEABLE END MILLS

SOLID CARBIDE END MILLS

HSS END MILLS

TECHNICAL DATA

Contents / MILLING TOOLS

CBN END MILLS

CBN(Cubic Boron Nitride) Machining High Hardened Steels up to HRc70 / Mirror Finish

CBN
END MILLS

i-Xmills, CARBIDE INSERT END MILLS

Various Applications Type of Inserts Available for General Steels, Pre-Hardened Steels, High Hardened Steels, Stainless Steels and Graphite

i-Xmill
END MILLS

i-Smart MODULAR TYPE END MILLS

For General Steels, Hardened Steels and Cast Iron

i-SMART
MODULAR
END MILLS

X5070 NANO SOLID CARBIDE END MILLS

For High Hardened Steels (HRc45 to HRc70) / High Speed Machining and Dry Cutting

X5070
END MILLS

4G Mill SOLID CARBIDE END MILLS

High Speed Cutting for Pre-Hardened Steels up to HRc55

4G MILL
END MILLS

X-POWER PRO SOLID CARBIDE END MILLS

For Pre-Hardened Steels up to HRc55

X-POWER
PRO
END MILLS

TitaNox-POWER SOLID CARBIDE END MILLS

High Speed Machining for Exotic Materials: Titanium, Inconel and Stainless Steels

TitaNox-
POWER
END MILLS

JET-POWER SOLID CARBIDE & HSS-PM END MILLS

For Exotic materials like Stainless Steels, Nickel Alloys and Titanium

JET-POWER
END MILLS

V7 PLUS SOLID CARBIDE END MILLS

High Performance Carbide End Mills for Steels, Cast Iron and Stainless Steels

V7 PLUS
END MILLS

ALU-POWER HPC SOLID CARBIDE END MILLS

For Aluminium, Aluminum Die Cast, Non-ferrous Alloys and Plastics

ALU-POWER
HPC
END MILLS

ALU-POWER SOLID CARBIDE & HSS-PM END MILLS

For Aluminium Alloys and Silent Cutting

ALU-
POWER
END MILLS

D-POWER GRAPHITE SOLID CARBIDE END MILLS (DIAMOND COATED)

For Graphites

D-POWER
GRAPHITE
END MILLS

D-POWER CFRP SOLID CARBIDE END MILLS (DIAMOND COATED)

For Composite Materials including CFRP and GFRP

D-POWER
CFRP
END MILLS

SOLID CARBIDE ROUTERS (DIAMOND COATED)

For Composite Materials including CFRP and GFRP

ROUTERS

CRX S SOLID CARBIDE END MILLS

DLC Coated End Mills for Copper

CRX S
END MILLS

K-2 SOLID CARBIDE END MILLS

General Purpose / Conventional or High Speed Milling / Wet & Dry Cutting

K-2
END MILLS

ONLY ONE COATED PM60 END MILLS

Perfect Solution of Carbide Chipping under Vibrations

ONLY ONE
COATED PM60
END MILLS

TANK-POWER HSS-PM END MILLS

High Toughness for Stainless Steels, Carbon steels and Alloy Steels / for General Application, Roughing & Finishing

TANK-
POWER
END MILLS

GENERAL HSS END MILLS

General Purpose / Coating Available

GENERAL
HSS
END MILLS

HSS MILLING CUTTERS

General Works. Available Dovetail, Woodruff Keyseat, T-slot, Side Milling Cutters and HSS (8% Cobalt) Corner Rounding, Shell End Mills

MILLING
CUTTERS

TECHNICAL DATA

TECHNICAL
DATA

SELECTION GUIDE



MILLING TOOLS

SERIES

FLUTE

HELIX ANGLE

CUTTING EDGE
SHAPE

SIZE MIN

SIZE MAX

PAGE

LENGTH

SURFACE TREATMENT

CBN

i-Xmill Insert

ESB94

ESD02

XMB110A

XMB120C

XMB260T

XMB130A

2

2

2

2

2

2

30°

0°

-

-

-

-

BALL
NOSE

CORNER
RADIUS

BALL
NOSE

BALL
NOSE

BALL
NOSE

BALL
NOSE

R0.2

D0.5

R4.0

R4.0

R4.0

R4.0

R1.5

D2.0

R16.5

R16.5

R16.5

R16.5

51

52

58

58

58

59

-

-

-

-

-

-

Uncoated

Uncoated

AlTiN

X-Coating

Z-Coating

AlTiN

GENERAL
PURPOSE

PRE-HARDENED
STEELS

HIGH HARDENED
STEELS













STAINLESS
STEELS



Please visit
globalyg1.com/mat
for material search

◎ : Excellent
○ : Good

ISO	VDI 3323	Material Description	HB	HRc	ESB94	ESD02	XMB110A	XMB120C	XMB260T	XMB130A	
P	1	Non-alloy steel	125				◎				
	2		190	13			◎				
	3		250	25			◎				
	4		270	28			◎				
	5		300	32			◎				
	6	Low alloy steel	180	10			◎				
	7		275	29			◎				
	8		300	32			◎				
	9		350	38					◎		
	10		High alloyed steel, and tool steel	200	15					○	
	11	325		35					◎		
M	12	Stainless steel	200	15						◎	
	13		240	23						◎	
	14		180	10						◎	
K	15	Grey cast iron	180	10				◎			
	16		260	26				◎			
	17	Nodular cast iron	160	3				◎			
	18		250	25				◎			
	19		130					◎			
20	Malleable cast iron	230	21					◎			
N	21	Aluminum- wrought alloy	60								
	22		100								
	23	Aluminum-cast, alloyed	75								
	24		90								
	25		130								
	26		110								
	27		90								
	28		100								
	29		Non Metallic Materials Duroplastic, Fiber Reinforced Plastic, Graphite, CFRP, GFRP, etc.								
	30										
S	31	Heat Resistant Super Alloys	200	15							
	32		280	30							
	33		250	25							
	34		350	38							
	35	320	34								
	36	Titanium Alloys	400 Rm								
	37		1050 Rm								
H	38	Hardened steel	550	55	◎	◎		○	◎		
	39		630	60	◎	◎		◎			
	40	Chilled Cast Iron	400	42					○		
	41	Hardened Cast Iron	550	55	◎	◎			◎		

i-Xmill Insert							i-Xmill Holder					
XMM110V	XMB110D	XMR110A	XMR120C	XMR260T	XMF110V	XMR110D	ZBC	ZBS	ZBT	ZRC	ZRS	ZRT
2	2	2	2	2	2	2	-	-	-	-	-	-
-	-	-	-	-	-	-	-	-	-	-	-	-
BALL NOSE	BALL NOSE	CORNER RADIUS	CORNER RADIUS	CORNER RADIUS	CORNER RADIUS	CORNER RADIUS	BALL NOSE	BALL NOSE	BALL NOSE	CORNER RADIUS	CORNER RADIUS	CORNER RADIUS
R4.0	R4.0	D8.0	D8.0	D8.0	D8.0	D8.0	-	-	-	-	-	-
R16.5	R16.5	D33.0	D33.0	D33.0	D33.0	D33.0	-	-	-	-	-	-
59	59	60	60	60	65	65	70	71	72	73	74	74
FULL RADIUS	-	-	-	-	HIGH FEED	-	STRAIGHT NECK	STRAIGHT NECK	TAPER NECK	STRAIGHT NECK	STRAIGHT NECK	TAPER NECK
Y-Coating	Diamond	AlTiN	X-Coating	Z-Coating	Y-Coating	Diamond	Carbide	Steel	Steel	Carbide	Steel	Steel
GENERAL PURPOSE	GRAPHITE	GENERAL PURPOSE STAINLESS STEELS	PRE-HARDENED STEELS	HIGH HARDENED STEELS	GENERAL PURPOSE	GRAPHITE						
												
⊙		⊙			⊙							1
⊙		⊙			⊙							2
⊙		⊙			⊙							3
⊙		⊙			⊙							4
		⊙			⊙							5
⊙		⊙			⊙							6 P
⊙		⊙			⊙							7
		⊙										8
⊙			⊙		⊙							9
			⊙									10
			⊙									11
		⊙										12
		⊙										13 M
		⊙										14
			⊙									15
			⊙									16
			⊙									17 K
			⊙									18
			⊙									19
			⊙									20
	○					○						21
	○					○						22
	○					○						23
	○					○						24
												25 N
												26
												27
	⊙					⊙						28
												29
												30
												31
												32
												33
												34 S
												35
												36
												37
			○		⊙							38
					⊙							39
					⊙							40 H
					⊙							41

HSS

CBN END MILLS

i-Xmill END MILLS

i-SMART MODULAR END MILLS

X5070 END MILLS

4G MILL END MILLS

X-POWER PRO END MILLS

TitaNox-POWER END MILLS

JET-POWER END MILLS

V7 PLUS END MILLS

ALU-POWER HPC END MILLS

ALU-POWER END MILLS

D-POWER GRAPHITE END MILLS

D-POWER CFRP END MILLS

ROUTERS

CRX S END MILLS

K-2 END MILLS

ONLY ONE COATED PM60 END MILLS

TANK-POWER END MILLS

GENERAL HSS END MILLS

MILLING CUTTERS

TECHNICAL DATA

SELECTION GUIDE



MILLING TOOLS

SERIES

FLUTE

HELIX ANGLE

CUTTING EDGE
SHAPE

SIZE MIN

SIZE MAX

PAGE

LENGTH

SURFACE TREATMENT

i-Smart Modular Head

XSEMD98	XSEME59	XSEME60	XSEME01	XSEME68	XSEME36
2	3	4	4	6	4
30°	30°	30°	27°/30° (MULTIPLE HELIX)	45°	27°/30° (MULTIPLE HELIX)
BALL NOSE	BALL NOSE	BALL NOSE	CORNER RADIUS	CORNER RADIUS	SQUARE
R5.0	R5.0	R5.0	D10.0	D10.0	D10.0
R16.0	R16.0	R16.0	D32.0	D32.0	D32.0
84	85	86	87	89	90

CENTER MATCH	CENTER MATCH	CENTER MATCH	-	-	-
--------------	--------------	--------------	---	---	---













Y-Coating	Y-Coating	Y-Coating	Y-Coating	Y-Coating	Y-Coating
-----------	-----------	-----------	-----------	-----------	-----------



Please visit
globalyg1.com/mat
for material search

◎ : Excellent
○ : Good

ISO	VDI 3323	Material Description	HB	HRc	XSEMD98	XSEME59	XSEME60	XSEME01	XSEME68	XSEME36	
P	1	Non-alloy steel	125		○	○	○	○	○	○	
	2		190	13	○	○	○	○	○	○	
	3		250	25	○	○	○	◎	○	◎	
	4		270	28	◎	◎	◎	◎	◎	◎	
	5		300	32	◎	◎	◎	◎	◎	◎	
	6	Low alloy steel	180	10	○	○	○	○	○	○	
	7		275	29	◎	◎	◎	◎	◎	◎	
	8		300	32	◎	◎	◎	◎	◎	◎	
	9		350	38	◎	◎	◎	◎	◎	◎	
	10		High alloyed steel, and tool steel	200	15	○	○	○	○	○	○
	11	325		35	◎	◎	◎	◎	◎	◎	
M	12	Stainless steel	200	15							
	13		240	23							
	14		180	10						○	
K	15	Grey cast iron	180	10	○	○	○	○	○	○	
	16		260	26	○	○	○	○	○	○	
	17	Nodular cast iron	160	3	○	○	○	○	○	○	
	18		250	25	○	○	○	○	○	○	
	19		130		○	○	○	○	○	○	
20	Malleable cast iron	230	21	○	○	○	○	○	○		
N	21	Aluminum- wrought alloy	60								
	22		100								
	23	Aluminum-cast, alloyed	75								
	24		90								
	25		130								
	26		110								
	27		90								
	28		100								
	29		Non Metallic Materials Duroplastic, Fiber Reinforced Plastic, Graphite, CFRP, GFRP, etc.								
	30										
S	31	Heat Resistant Super Alloys	200	15							
	32		280	30							
	33		250	25							
	34		350	38							
	35		320	34							
	36	Titanium Alloys	400 Rm								
	37		1050 Rm								
H	38	Hardened steel	550	55	○	○	○	○	○	○	
	39		630	60	○	○	○	○	○	○	
	40	Chilled Cast Iron	400	42	◎	◎	◎	◎	◎	◎	
	41	Hardened Cast Iron	550	55	○	○	○	○	○	○	

	i-Smart Modular Holder			X5070									
XSEME75	ZMC	ZMS	ZMT	G8B59	G8B54	G8A46	G8A54	G8A28	G8A38	G8A53	G8A59	G8D62	
6	-	-	-	4	4	2	2	2	2	2	3	4	
45°	-	-	-	0°	0°	30°	30°	30°	30°	30°	30°	30°	
SQUARE	-	-	-	CORNER RADIUS	CORNER RADIUS	BALL NOSE	BALL NOSE	BALL NOSE	BALL NOSE	BALL NOSE	BALL NOSE	BALL NOSE	
D10.0	-	-	-	D2.0	D2.0	R0.05	R0.25	R0.05	R0.5	R0.2	R1.5	R1.5	
D32.0	-	-	-	D12.0	D16.0	R2.0	R1.0	R6.0	R12.5	R1.0	R10.0	R10.0	
91	92	93	94	105	106	107	111	112	114	115	116	117	
-	STRAIGHT NECK TYPE	STRAIGHT NECK TYPE	TAPER NECK TYPE	HIGH FEED	HIGH FEED LONG SHANK	RIB PROCESSING	RIB PROCESSING	-	EXTENDED NECK	MINIATURE	Center Match	Center Match	
Y-Coating	Carbide	Steel	Steel	Blue Coating	Blue Coating	Blue Coating	Blue Coating	Blue Coating	Blue Coating	Blue Coating	Blue Coating	Blue Coating	
													
○													1
○													2
◎													3
◎													4
◎				○	○	○	○	○	○	○	○	○	5
○													6 P
◎													7
◎				○	○	○	○	○	○	○	○	○	8
◎				○	○	○	○	○	○	○	○	○	9
○													10
◎				○	○	○	○	○	○	○	○	○	11
													12
													13 M
													14
○													15
○													16
○													17 K
○													18
○													19
○													20
													21
													22
													23
													24
													25 N
													26
													27
													28
													29
													30
													31
													32
													33
													34 S
													35
													36
													37
○				◎	◎	◎	◎	◎	◎	◎	◎	◎	38
○				◎	◎	◎	◎	◎	◎	◎	◎	◎	39
◎				○	○	○	○	○	○	○	○	○	40 H
○				◎	◎	◎	◎	◎	◎	◎	◎	◎	41

HSS

CBN END MILLS

i-Xmill END MILLS

i-SMART MODULAR END MILLS

X5070 END MILLS

4G MILL END MILLS

X-POWER PRO END MILLS

TitaNox-POWER END MILLS

JET-POWER END MILLS

V7 PLUS END MILLS

ALU-POWER HPC END MILLS

ALU-POWER END MILLS

D-POWER GRAPHITE END MILLS

D-POWER CFRP END MILLS

ROUTERS

CRX S END MILLS

K-2 END MILLS

ONLY ONE COATED PM60 END MILLS

TANK-POWER END MILLS

GENERAL HSS END MILLS

MILLING CUTTERS

TECHNICAL DATA

SELECTION GUIDE



MILLING TOOLS

SERIES

FLUTE

HELIX ANGLE

CUTTING EDGE
SHAPE

SIZE MIN

SIZE MAX

PAGE

LENGTH

SURFACE TREATMENT

X5070

SERIES	G8A60	G8A36	G8A52	G8A50	G8A47	G8A37	G8B08	G8A39
FLUTE	2	2	2	2	4	4	4	6
HELIX ANGLE	30°	30°	30°	30°	30°	30°	30°	45°
CUTTING EDGE SHAPE	CORNER RADIUS	CORNER RADIUS	CORNER RADIUS	CORNER RADIUS	CORNER RADIUS	CORNER RADIUS	CORNER RADIUS	CORNER RADIUS
SIZE MIN	D0.5	D0.3	D0.5	D0.3	D3.0	D1.0	D6.0	D6.0
SIZE MAX	D12.0	D20.0	D2.0	D2.0	D12.0	D20.0	D12.0	D20.0
PAGE	118	123	125	126	127	128	129	130

LENGTH	RIB PROCESSING	EXTENDED NECK	RIB PROCESSING	MINIATURE	EXTENDED NECK	EXTENDED NECK	EXTENDED NECK	EXTENDED NECK
SURFACE TREATMENT	Blue Coating	Blue Coating	Blue Coating	Blue Coating	Blue Coating	Blue Coating	Blue Coating	Blue Coating

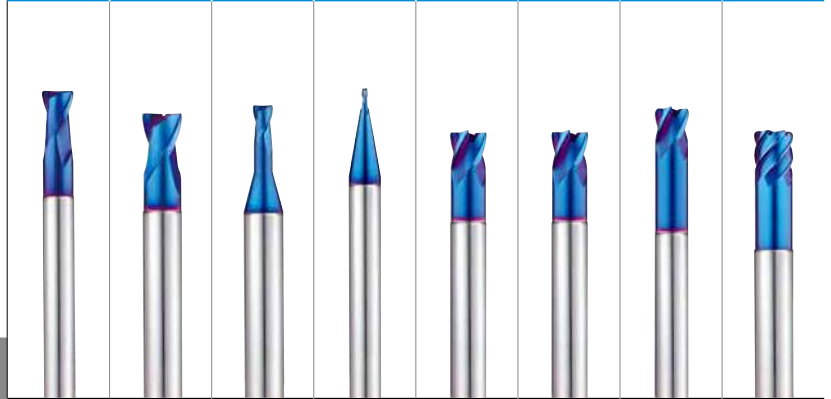













Please visit
globalyg1.com/mat
for material search

◎ : Excellent
○ : Good

ISO	VDI 3323	Material Description	HB	HRc	G8A60	G8A36	G8A52	G8A50	G8A47	G8A37	G8B08	G8A39	
P	1	Non-alloy steel	125										
	2		190	13									
	3		250	25									
	4		270	28									
	5		300	32	○	○	○	○	○	○	○	○	
	6	Low alloy steel	180	10									
	7		275	29									
	8		300	32	○	○	○	○	○	○	○	○	
	9		350	38	○	○	○	○	○	○	○	○	
	10		High alloyed steel, and tool steel	200	15								
	11	325		35	○	○	○	○	○	○	○	○	
M	12	Stainless steel	200	15									
	13		240	23									
	14		180	10									
K	15	Grey cast iron	180	10									
	16		260	26									
	17	Nodular cast iron	160	3									
	18		250	25									
	19		130										
20	Malleable cast iron	230	21										
N	21	Aluminum-wrought alloy	60										
	22		100										
	23	Aluminum-cast, alloyed	75										
	24		90										
	25		130										
	26		Copper and	110									
	27		Copper Alloys	90									
	28		(Bronze / Brass)	100									
	29		Non Metallic Materials Duroplastic, Fiber Reinforced Plastic, Graphite, CFRP, GFRP, etc.										
	30												
S	31	Heat Resistant Super Alloys	200	15									
	32		280	30									
	33		250	25									
	34		350	38									
	35	320	34										
	36	Titanium Alloys	400 Rm										
	37		1050 Rm										
H	38	Hardened steel	550	55	◎	◎	◎	◎	◎	◎	◎	◎	
	39		630	60	◎	◎	◎	◎	◎	◎	◎		
	40	Chilled Cast Iron	400	42	○	○	○	○	○	○	○		
	41	Hardened Cast Iron	550	55	◎	◎	◎	◎	◎	◎	◎		

X5070					4G Mills						
G8A45	G8A01	G8A02	G8D63	G8D64	SEMD98	SEM846	SEM846	SEMD99	SEME61	SEME01	SEME64
2	2	4	6&8	6&8	2	2	2	2	2	4	4
30°	30°	30°	45°	45°	30°	30°	30°	30°	30°	27°/30° (MULTIPLE HELIX)	27°/30° (MULTIPLE HELIX)
SQUARE	SQUARE	SQUARE	SQUARE	SQUARE	BALL NOSE	BALL NOSE	BALL NOSE	CORNER RADIUS	CORNER RADIUS	CORNER RADIUS	CORNER RADIUS
D0.1	D0.1	D1.0	D6.0	D6.0	R0.05	R0.05	R0.25	D0.2	D0.2	D1.0	D1.0
D4.0	D20.0	D20.0	D25.0	D25.0	R12.5	R6.0	R1.0	D20.0	D20.0	D20.0	D20.0
131	135	136	137	138	166	172	182	185	193	212	219
RIB PROCESSING	EXTENDED NECK	EXTENDED NECK	LONG LENGTH	EXTRA LONG LENGTH	-	EXTENDED NECK	EXTENDED NECK (6mm Shank)	-	EXTENDED NECK	-	EXTENDED NECK
Blue Coating	Blue Coating	Blue Coating	Blue Coating	Blue Coating	Y-Coating	Y-Coating	Y-Coating	Y-Coating	Y-Coating	Y-Coating	Y-Coating

											
---	---	---	---	---	---	---	---	---	---	---	---

					○	○	○	○	○	○	○	1
					○	○	○	○	○	○	○	2
					○	○	○	○	○	○	○	3
					◎	◎	◎	◎	◎	◎	◎	4
○	○	○	○	○	◎	◎	◎	◎	◎	◎	◎	5
					○	○	○	○	○	○	○	6 P
					◎	◎	◎	◎	◎	◎	◎	7
○	○	○	○	○	◎	◎	◎	◎	◎	◎	◎	8
○	○	○	○	○	◎	◎	◎	◎	◎	◎	◎	9
○	○	○	○	○	◎	◎	◎	◎	◎	◎	◎	10
○	○	○	○	○	◎	◎	◎	◎	◎	◎	◎	11
												12
												13 M
												14
					○	○	○	○	○	○	○	15
					○	○	○	○	○	○	○	16
					○	○	○	○	○	○	○	17
					○	○	○	○	○	○	○	18 K
					○	○	○	○	○	○	○	19
					○	○	○	○	○	○	○	20
												21
												22
												23
												24
												25 N
												26
												27
												28
												29
												30
												31
												32
												33
												34 S
												35
												36
												37
◎	◎	◎	◎	◎	○	○	○	○	○	○	○	38
◎	◎	◎	◎	◎	○	○	○	○	○	○	○	39
○	○	○	○	○	◎	◎	◎	◎	◎	◎	◎	40
◎	◎	◎	◎	◎	○	○	○	○	○	○	○	41

HSS

CBN
END MILLS

i-Xmill
END MILLS

i-SMART
MODULAR
END MILLS

X5070
END MILLS

4G MILL
END MILLS

X-POWER
PRO
END MILLS

TitaNox-
POWER
END MILLS

JET-POWER
END MILLS

V7 PLUS
END MILLS

ALU-POWER
HPC
END MILLS

ALU-
POWER
END MILLS

D-POWER
GRAPHITE
END MILLS

D-POWER
CFRP
END MILLS

ROUTERS

CRX S
END MILLS

K-2
END MILLS

ONLY ONE
COATED PM60
END MILLS

TANK-
POWER
END MILLS

GENERAL
HSS
END MILLS

MILLING
CUTTERS

TECHNICAL
DATA

SELECTION GUIDE



MILLING TOOLS

SERIES	4G Mills									
	SEME35	SEME35	SEME35	SEME70	SEM845	SEME36	SEME71	SEME72	SEME73	SEME75
FLUTE	2	2	2	2	2	4	4	4	4	6
HELIX ANGLE	30°	30°	30°	30°	30°	27°/30° (MULTIPLE HELIX)	35°/38° (MULTIPLE HELIX)	30°	30°	45°
CUTTING EDGE SHAPE	SQUARE	SQUARE	SQUARE	SQUARE	SQUARE	SQUARE	SQUARE	SQUARE	SQUARE	SQUARE
SIZE MIN	D0.1	D0.1	D0.1	D1.0	D0.1	D0.8	D1.0	D1.0	D1.0	D6.0
SIZE MAX	D25.0	D4.0	D3.0	D25.0	D12.0	D25.0	D20.0	D25.0	D12.0	D20.0
PAGE	234	237	238	239	245	254	256	260	266	271
LENGTH	-	4mm Shank	3mm Shank	LONG LENGTH	EXTENDED NECK	-	Sharp Corner Removal	LONG LENGTH	EXTENDED NECK	-
SURFACE TREATMENT	Y-Coating	Y-Coating	Y-Coating	Y-Coating	Y-Coating	Y-Coating	Y-Coating	Y-Coating	Y-Coating	Y-Coating















Please visit globalyg1.com/mat for material search

◎ : Excellent
○ : Good



ISO	VDI 3323	Material Description	HB	HRc	SEME35	SEME35	SEME35	SEME70	SEM845	SEME36	SEME71	SEME72	SEME73	SEME75
P	1	Non-alloy steel	125		○	○	○	○	○	○	○	○	○	○
	2		190	13	○	○	○	○	○	○	○	○	○	○
	3		250	25	◎	◎	◎	◎	◎	◎	◎	◎	◎	◎
	4		270	28	◎	◎	◎	◎	◎	◎	◎	◎	◎	◎
	5		300	32	◎	◎	◎	◎	◎	◎	◎	◎	◎	◎
	6	Low alloy steel	180	10	○	○	○	○	○	○	○	○	○	○
	7		275	29	◎	◎	◎	◎	◎	◎	◎	◎	◎	◎
	8		300	32	◎	◎	◎	◎	◎	◎	◎	◎	◎	◎
	9		350	38	◎	◎	◎	◎	◎	◎	◎	◎	◎	◎
	10		High alloyed steel, and tool steel	200	15	○	○	○	○	○	○	○	○	○
	11	325		35	◎	◎	◎	◎	◎	◎	◎	◎	◎	◎
M	12	Stainless steel	200	15					○				○	
	13		240	23					○				○	
	14		180	10	○	○	○		○	○	○		○	
K	15	Grey cast iron	180	10	○	○	○	○	○	○	○	○	○	○
	16		260	26	○	○	○	○	○	○	○	○	○	
	17	Nodular cast iron	160	3	○	○	○	○	○	○	○	○	○	○
	18		250	25	○	○	○	○	○	○	○	○	○	
	19		130		○	○	○	○	○	○	○	○	○	
20	Malleable cast iron	230	21	○	○	○	○	○	○	○	○	○	○	
N	21	Aluminum-wrought alloy	60											
	22		100											
	23	Aluminum-cast, alloyed	75											
	24		90											
	25		130											
	26		Copper and Copper Alloys	110										
	27		90											
	28		(Bronze / Brass)	100										
	29		Non Metallic Materials Duroplastic, Fiber Reinforced Plastic, Graphite, CFRP, GFRP, etc.											
	30													
S	31	Heat Resistant Super Alloys	200	15										
	32		280	30										
	33		250	25										
	34		350	38										
	35	320	34											
	36	Titanium Alloys	400 Rm											
	37		1050 Rm											
H	38	Hardened steel	550	55	○	○	○	○	○	○	○	○	○	○
	39		630	60										
	40	Chilled Cast Iron	400	42	◎	◎	◎	◎	◎	◎	◎	◎	◎	
41	Hardened Cast Iron	550	55	○	○	○	○	○	○	○	○	○		

4G Mills X-Speed Rougher				X-Power Pro								
G9D75 G9D67	G9D76 G9D68	G9D77 G9D69	GAE53	GM876	GM813	GM886	GM902	GM815	GM818	GM8A1	GM839	
4&5	4&5	4&5	4&5	2	2	2	2	4	2	2	4	
44°~45° (MULTIPLE HELIX) CORNER RADIUS ROUGHING	44°~45° (MULTIPLE HELIX) CORNER RADIUS ROUGHING	44°~45° (MULTIPLE HELIX) CORNER RADIUS ROUGHING	44°~45° (MULTIPLE HELIX) CORNER RADIUS ROUGHING	30°	30°	30°	30°	30°	30°	30°	30°	
D6.0	D6.0	D6.0	D6.0	R0.5	R0.5	R0.25	R0.5	R1.0	D4.0	D1.0	D2.0	
D20.0	D20.0	D20.0	D20.0	R8.0	R10.0	R3.0	R4.0	R8.0	D12.0	D6.0	D12.0	
273	273	274	275	350	351	352	354	355	356	357	359	
SHORT LENGTH	LONG LENGTH	LONG LENGTH	HSS-PM SHORT LENGTH	SHORT LENGTH	LONG LENGTH	RIB PROCESSING	TAPER NECK	LONG LENGTH	LONG LENGTH	RIB PROCESSING	STUB LENGTH	
X-Coating	X-Coating	X-Coating	X-Coating	Y-Coating	Y-Coating	Y-Coating	Y-Coating	Y-Coating	Y-Coating	Y-Coating	Y-Coating	
												
○	○	○	○	⊙	⊙	⊙	○	○	○	○	○	1
○	○	○	○	○	○	○	○	○	○	○	○	2
⊙	⊙	⊙	⊙	⊙	⊙	⊙	○	○	○	○	○	3
⊙	⊙	⊙	⊙	⊙	⊙	⊙	⊙	⊙	⊙	⊙	⊙	4
⊙	⊙	⊙	○	⊙	⊙	⊙	⊙	⊙	⊙	⊙	⊙	5
○	○	○	○	○	○	○	○	○	○	○	○	6 P
⊙	⊙	⊙	⊙	⊙	⊙	⊙	⊙	⊙	⊙	⊙	⊙	7
⊙	⊙	⊙	○					⊙	⊙	⊙	⊙	8
○	○	○	○					○	○	○	○	9
⊙	⊙	⊙	○	○	○	○		⊙	⊙	⊙	⊙	10
○	○	○	○	○	○	○						11
○	○	○	○	○	○	○						12
○	○	○	○	○	○	○						13 M
○	○	○	⊙	○	○	○						14
⊙	⊙	⊙	⊙	○	○	○		○	○	○	○	15
⊙	⊙	⊙	⊙	○	○	○		○	○	○	○	16
⊙	⊙	⊙	⊙					○	○	○	○	17 K
⊙	⊙	⊙	⊙					○	○	○	○	18
⊙	⊙	⊙	⊙					○	○	○	○	19
⊙	⊙	⊙	⊙					○	○	○	○	20
												21
												22
												23
												24
												25 N
○	○	○	○									26
○	○	○	○									27
○	○	○	○									28
												29
												30
												31
												32
												33
				○	○	○	○					34 S
				○	○	○	○					35
				⊙	⊙	⊙	⊙					36
				○	○	○	○					37
				○	○	○	○	○	○	○	○	38
								○				39
				⊙	⊙	⊙	⊙	⊙	⊙	⊙	⊙	40 H
				○	○	○	○	○	○	○	○	41

HSS

CBN
END MILLS

i-Xmill
END MILLS

i-SMART
MODULAR
END MILLS

X5070
END MILLS

4G MILL
END MILLS

X-POWER
PRO
END MILLS

TitaNox-
POWER
END MILLS

JET-POWER
END MILLS

V7 PLUS
END MILLS

ALU-POWER
HPC
END MILLS

ALU-
POWER
END MILLS

D-POWER
GRAPHITE
END MILLS

D-POWER
CFRP
END MILLS

ROUTERS

CRX S
END MILLS

K-2
END MILLS

ONLY ONE
COATED PM60
END MILLS

TANK-
POWER
END MILLS

GENERAL
HSS
END MILLS

MILLING
CUTTERS

TECHNICAL
DATA

SELECTION GUIDE



MILLING TOOLS

SERIES	X-Power Pro								
	GM819	GM810	GM883	GM895	GM811	GM817	GM812	GM834	GM814
FLUTE	4	2	2	3	4	4	6&8	6	3&4
HELIX ANGLE	30°	30°	30°	38°	30°	30°	45°	45°	20°
CUTTING EDGE SHAPE	CORNER RADIUS	SQUARE	SQUARE	SQUARE	SQUARE	SQUARE	SQUARE	SQUARE	ROUGHING
SIZE MIN	D3.0	D0.4	D0.4	D1.0	D2.0	D2.0	D6.0	D6.0	D6.0
SIZE MAX	D20.0	D20.0	D6.0	D16.0	D25.0	D20.0	D20.0	D25.0	D20.0
PAGE	360	361	363	366	367	368	369	370	371

LENGTH	LONG LENGTH	SHORT LENGTH	RIB PROCESSING	SHORT LENGTH	SHORT LENGTH	LONG LENGTH	LONG LENGTH	EXTRA LONG LENGTH	LONG LENGTH
SURFACE TREATMENT	Y-Coating	Y-Coating	Y-Coating	Y-Coating	Y-Coating	Y-Coating	Y-Coating	Y-Coating	Y-Coating



Please visit globalyg1.com/mat for material search

◎ : Excellent
○ : Good

ISO	VDI 3323	Material Description	HB	HRc	GM819	GM810	GM883	GM895	GM811	GM817	GM812	GM834	GM814	
P	1	Non-alloy steel	125		○	○	○	○	○	○	○	○	○	
	2		190	13	○	○	○	○	○	○	○	○	○	
	3		250	25	◎	◎	◎	◎	◎	◎	◎	◎	◎	
	4		270	28	◎	◎	◎	◎	◎	◎	◎	◎	◎	
	5		300	32	◎	◎	◎	◎	◎	◎	◎	◎	◎	
	6	Low alloy steel	180	10	○	○	○	○	○	○	○	○	○	
	7		275	29	◎	◎	◎	◎	◎	◎	◎	◎	◎	
	8		300	32	◎	◎	◎	◎	◎	◎	◎	◎	◎	
	9		350	38	◎	◎	◎	◎	◎	◎	◎	◎	◎	
	10		High alloyed steel, and tool steel	200	15	○	○	○	○	○	○	○	○	○
	11	325		35	◎	◎	◎	◎	◎	◎	◎	◎	◎	
M	12	Stainless steel	200	15	○	○	○	○	○	○	○	○	○	
	13		240	23	○	○	○	○	○	○	○	○		
	14		180	10	○	○	○	○	○	○	○	○		
K	15	Grey cast iron	180	10	○	○	○	○	○	○	○	○	○	
	16		260	26	○	○	○	○	○	○	○	○		
	17	Nodular cast iron	160	3	○	○	○	○	○	○	○	○	○	
	18		250	25	○	○	○	○	○	○	○	○		
	19		130		○	○	○	○	○	○	○	○		
20	Malleable cast iron	230	21	○	○	○	○	○	○	○	○	○		
N	21	Aluminum-wrought alloy	60											
	22		100											
	23	Aluminum-cast, alloyed	75											
	24		90											
	25		130											
	26		Copper and	110										
	27		Copper Alloys	90										
	28		(Bronze / Brass)	100										
	29		Non Metallic Materials Duroplastic, Fiber Reinforced Plastic, Graphite, CFRP, GFRP, etc.											
	30													
S	31	Heat Resistant Super Alloys	200	15										
	32		280	30										
	33		250	25										
	34		350	38										
	35	320	34											
	36	Titanium Alloys	400 Rm											
	37		1050 Rm											
H	38	Hardened steel	550	55	○	○	○	○	○	○	○	○	○	
	39		630	60										
	40	Chilled Cast Iron	400	42	◎	◎	◎	◎	◎	◎	◎	◎		
	41	Hardened Cast Iron	550	55	○	○	○	○	○	○	○	○		

TitaNox-Power						Jet-Power					
GMG40 GMG41	GMG28 GMG29	GMG30 GMG31	GMG24 GMG25	GMG26 GMG27	EHE54 EHE55	EH911 EH912	EH913 EH914	EH830 EH840	EH915 EH916	EE515	EH852 EH862
4	5	5	5	5	5	2	4	3&4	6&8	4&6	Multi Flute
43°/45° (MULTIPLE HELIX)	43°/44°/45° (MULTIPLE HELIX)	43°/44°/45° (MULTIPLE HELIX)	43°/44°/45° (MULTIPLE HELIX)	43°/44°/45° (MULTIPLE HELIX)	40°	35°	35°	50°	45°	30°	30°
CORNER RADIUS	CORNER RADIUS	CORNER RADIUS	SQUARE	SQUARE	ROUGHING CORNER RADIUS	SQUARE	SQUARE	SQUARE	SQUARE	SQUARE	ROUGHING
D6.0	D6.0	D6.0	D6.0	D6.0	D6.0	D1.0	D2.0	D6.0	D6.0	D3.0	D6.0
D25.0	D25.0	D25.0	D25.0	D25.0	D25.0	D25.0	D25.0	D25.0	D25.0	D25.0	D25.0
398	400	401	403	404	405	414	416	418	419	420	421
LONG LENGTH DOUBLE CORE	SHORT LENGTH	LONG LENGTH	SHORT LENGTH	LONG LENGTH	-	SHORT LENGTH	SHORT LENGTH	LONG LENGTH	LONG LENGTH	HSS-PM SHORT LENGTH	SHORT LENGTH
Y-Coating	Y-Coating	Y-Coating	Y-Coating	Y-Coating	TiAIN	TiAIN	TiAIN	TiAIN	TiAIN	TiAIN	TiAIN



○	○	○	○	○		○	○	○	○	○	○	1
○	○	○	○	○		○	○	○	○	○	○	2
○	○	○	○	○		⊙	⊙	⊙	⊙	⊙	⊙	3
○	○	○	○	○		⊙	⊙	⊙	⊙	⊙	⊙	4
○	○	○	○	○		⊙	⊙	⊙	⊙	⊙	⊙	5
○	○	○	○	○		⊙	⊙	⊙	⊙	⊙	⊙	6 P
○	○	○	○	○		⊙	⊙	⊙	⊙	⊙	⊙	7
○	○	○	○	○		⊙	⊙	⊙	⊙	⊙	⊙	8
○	○	○	○	○		⊙	⊙	⊙	⊙	⊙	⊙	9
○	○	○	○	○		⊙	⊙	⊙	⊙	⊙	⊙	10
○	○	○	○	○		⊙	⊙	⊙	⊙	⊙	⊙	11
⊙	⊙	⊙	⊙	⊙	○	○	○	○	○	○	○	12
⊙	⊙	⊙	⊙	⊙	○	○	○	○	○	○	○	13 M
⊙	⊙	⊙	⊙	⊙	○	⊙	⊙	⊙	⊙	⊙	⊙	14
○	○	○	○	○								15
○	○	○	○	○								16
○	○	○	○	○								17 K
○	○	○	○	○								18
○	○	○	○	○								19
○	○	○	○	○								20
												21
												22
												23
												24
												25 N
												26
												27
												28
												29
												30
○	○	○	○	○	○			○	○	○	○	31
○	○	○	○	○	○			○	○	○	○	32
○	○	○	○	○	○			○	○	○	○	33
○	○	○	○	○	○			○	○	○	○	34 S
○	○	○	○	○	○			○	○	○	○	35
⊙	⊙	⊙	⊙	⊙	⊙	⊙	⊙	⊙	⊙	⊙	⊙	36
⊙	⊙	⊙	⊙	⊙	⊙	⊙	⊙	⊙	⊙	⊙	⊙	37
												38
												39
						○	○	○	○	○	○	40 H
												41

HSS

CBN
END MILLS

i-Xmill
END MILLS

i-SMART
MODULAR
END MILLS

X5070
END MILLS

4G MILL
END MILLS

X-POWER
PRO
END MILLS

TitaNox-
POWER
END MILLS

JET-POWER
END MILLS

V7 PLUS
END MILLS

ALU-POWER
HPC
END MILLS

ALU-
POWER
END MILLS

D-POWER
GRAPHITE
END MILLS

D-POWER
CFRP
END MILLS

ROUTERS

CRX S
END MILLS

K-2
END MILLS

ONLY ONE
COATED PM60
END MILLS

TANK-
POWER
END MILLS

GENERAL
HSS
END MILLS

MILLING
CUTTERS

TECHNICAL
DATA

SELECTION GUIDE



MILLING TOOLS

SERIES

FLUTE

HELIX ANGLE

CUTTING EDGE
SHAPE

SIZE MIN

SIZE MAX

PAGE

LENGTH

SURFACE TREATMENT

Jet-Power

V7 Plus













EH831 EH841	EH917 EH918	EH919 EH920	EH921 EH942	GMG55 GMG56	GMF54 GMF55	GMF58 GMF59	GMF62 GMF63
Multi Flute	Multi Flute	Multi Flute	Multi Flute	4	4	4	4
30°	45°	45°	45°	35°/37° (MULTIPLE HELIX)	35°/37° (MULTIPLE HELIX)	35°/37° (MULTIPLE HELIX)	35°/37° (MULTIPLE HELIX)
ROUGHING	ROUGHING	ROUGHING	ROUGHING	BALL NOSE	CORNER RADIUS	CORNER RADIUS	CORNER RADIUS
D6.0	D6.0	D4.0	D6.0	R1.5	D3.0	D3.0	D3.0
D25.0	D20.0	D25.0	D20.0	R12.5	D20.0	D25.0	D20.0
422	423	424	425	442	443	444	445
LONG LENGTH	SHORT LENGTH	LONG LENGTH	LONG LENGTH	LONG LENGTH	SHORT LENGTH	LONG LENGTH	LONG LENGTH with NECK
TiAlN	TiAlN	TiAlN	TiAlN	Y-Coating	Y-Coating	Y-Coating	Y-Coating



Please visit
globalyg1.com/mat
for material search

◎ : Excellent
○ : Good

ISO	VDI 3323	Material Description	HB	HRc									
P	1	Non-alloy steel	125		○	○	○	○	◎	◎	◎	◎	
	2		190	13	○	○	○	○	◎	◎	◎	◎	
	3		250	25	◎	◎	◎	◎	◎	◎	◎	◎	
	4		270	28	◎	◎	◎	◎	◎	◎	◎	◎	
	5		300	32	◎	◎	◎	◎	◎	◎	◎	◎	
	6	Low alloy steel	180	10	○	○	○	○	◎	◎	◎	◎	
	7		275	29	◎	◎	◎	◎	◎	◎	◎	◎	
	8		300	32	◎	◎	◎	◎	◎	◎	◎	◎	
	9		350	38	◎	◎	◎	◎	◎	◎	◎	◎	
	10		High alloyed steel, and tool steel	200	15	○	○	○	○	◎	◎	◎	◎
	11	325		35	◎	◎	◎	◎	◎	◎	◎	◎	
M	12	Stainless steel	200	15	○	○	○	○	◎	◎	◎	◎	
	13		240	23	○	○	○	○	◎	◎	◎	◎	
	14		180	10	◎	◎	◎	◎	◎	◎	◎	◎	
K	15	Grey cast iron	180	10					◎	◎	◎	◎	
	16		260	26					◎	◎	◎	◎	
	17	Nodular cast iron	160	3					◎	◎	◎	◎	
	18		250	25					◎	◎	◎	◎	
	19		130						◎	◎	◎	◎	
20	Malleable cast iron	230	21					◎	◎	◎	◎		
N	21	Aluminum- wrought alloy	60										
	22		100										
	23	Aluminum-cast, alloyed	75										
	24		90										
	25		130										
	26		Copper and Copper Alloys (Bronze / Brass)	110									
	27		90										
	28		100										
	29		Non Metallic Materials Duroplastic, Fiber Reinforced Plastic, Graphite, CFRP, GFRP, etc.										
	30												
S	31	Heat Resistant Super Alloys	200	15	○	○	○	○	○	○	○	○	
	32		280	30	○	○	○	○	○	○	○	○	
	33		250	25	○	○	○	○	○	○	○	○	
	34		350	38	○	○	○	○	○	○	○	○	
	35		320	34	○	○	○	○	○	○	○	○	
	36	Titanium Alloys	400 Rm		◎	◎	◎	◎	○	○	○	○	
	37		1050 Rm		◎	◎	◎	◎	○	○	○	○	
H	38	Hardened steel	550	55									
	39		630	60									
	40	Chilled Cast Iron	400	42	○	○	○	○					
41	Hardened Cast Iron	550	55										

V7 Plus								Alu-Power HPC				
GMF52 GMF53	GMF56 GMF57	GMF60 GMF61	GMG16 GMG17	GMG18 GMG19	GMG12 GMG13	GMG14 GMG15	EMB72 EMB73	E5H24 JAH24	E5H25 JAH25	E5H22 JAH22	E5H23 JAH23	
4	4	4	6	6	6	6	5	3	3	3	3	
35°/37° (MULTIPLE HELIX)	35°/37° (MULTIPLE HELIX)	35°/37° (MULTIPLE HELIX)	45°	45°	45°	45°	41°~45°	37°	37°	37°	37°	
SQUARE	SQUARE	SQUARE	CORNER RADIUS	CORNER RADIUS	SQUARE	SQUARE	SQUARE	CORNER RADIUS	CORNER RADIUS	SQUARE	SQUARE	
D3.0	D3.0	D3.0	D6.0	D6.0	D6.0	D6.0	D6.0	D6.0	D6.0	D3.0	D6.0	
D20.0	D25.0	D20.0	D25.0	D25.0	D25.0	D25.0	D25.0	D20.0	D20.0	D25.0	D20.0	
448	449	450	452	453	455	456	457	466	469	472	473	
SHORT LENGTH	LONG LENGTH	LONG LENGTH with NECK	LONG LENGTH	EXTRA LONG LENGTH	LONG LENGTH	EXTRA LONG LENGTH	LONG LENGTH	-	EXTENDED NECK	-	EXTENDED NECK	
Y-Coating	Y-Coating	Y-Coating	Y-Coating	Y-Coating	Y-Coating	Y-Coating	AlTiN	Uncoated	Uncoated	Uncoated	Uncoated	
							V7 INOX	DLC	DLC	DLC	DLC	
												
⊙	⊙	⊙	⊙	⊙	⊙	⊙	⊙					1
⊙	⊙	⊙	⊙	⊙	⊙	⊙	⊙					2
⊙	⊙	⊙	⊙	⊙	⊙	⊙	○					3
⊙	⊙	⊙	⊙	⊙	⊙	⊙	○					4
⊙	⊙	⊙	⊙	⊙	⊙	⊙	○					5
⊙	⊙	⊙	⊙	⊙	⊙	⊙	○					6 P
⊙	⊙	⊙	⊙	⊙	⊙	⊙	○					7
⊙	⊙	⊙	⊙	⊙	⊙	⊙	○					8
⊙	⊙	⊙	⊙	⊙	⊙	⊙	○					9
⊙	⊙	⊙	⊙	⊙	⊙	⊙	○					10
⊙	⊙	⊙	⊙	⊙	⊙	⊙	○					11
⊙	⊙	⊙	⊙	⊙	⊙	⊙	○					12
⊙	⊙	⊙	⊙	⊙	⊙	⊙	○					13 M
⊙	⊙	⊙	⊙	⊙	⊙	⊙	○					14
⊙	⊙	⊙	⊙	⊙	⊙	⊙	○					15
⊙	⊙	⊙	⊙	⊙	⊙	⊙	○					16
⊙	⊙	⊙	⊙	⊙	⊙	⊙	○					17 K
⊙	⊙	⊙	⊙	⊙	⊙	⊙	○					18
⊙	⊙	⊙	⊙	⊙	⊙	⊙	○					19
⊙	⊙	⊙	⊙	⊙	⊙	⊙	○					20
								⊙	⊙	⊙	⊙	21
								⊙	⊙	⊙	⊙	22
								⊙	⊙	⊙	⊙	23
								○	○	○	○	24
								○	○	○	○	25 N
								○	○	○	○	26
								○	○	○	○	27
								○	○	○	○	28
								○	○	○	○	29
												30
○	○	○	○	○	○	○	○					31
○	○	○	○	○	○	○	○					32
○	○	○	○	○	○	○	○					33
○	○	○	○	○	○	○	○					34 S
○	○	○	○	○	○	○	○					35
○	○	○	○	○	○	○	⊙					36
○	○	○	○	○	○	○	⊙					37
												38
												39 H
												40
												41

HSS

CBN
END MILLS

i-Xmill
END MILLS

i-SMART
MODULAR
END MILLS

X5070
END MILLS

4G MILL
END MILLS

X-POWER
PRO
END MILLS

TitaNox-
POWER
END MILLS

JET-POWER
END MILLS

V7 PLUS
END MILLS

ALU-POWER
HPC
END MILLS

ALU-
POWER
END MILLS

D-POWER
GRAPHITE
END MILLS

D-POWER
CFRP
END MILLS

ROUTERS

CRX S
END MILLS

K-2
END MILLS

ONLY ONE
COATED PM60
END MILLS

TANK-
POWER
END MILLS

GENERAL
HSS
END MILLS

MILLING
CUTTERS

TECHNICAL
DATA

SELECTION GUIDE



MILLING TOOLS

SERIES

FLUTE

HELIX ANGLE

CUTTING EDGE
SHAPE

SIZE MIN

SIZE MAX

PAGE

LENGTH

SURFACE TREATMENT

Alu-Power

	E5910	E5908	E5909	E5930	E5E51	E5E47	E5E48	E5522 E5521
SERIES	E5910	E5908	E5909	E5930	E5E51	E5E47	E5E48	E5522 E5521
FLUTE	2	3	2	2	3	1	2	2
HELIX ANGLE	50°	40°	30°	25°	45°	30°	45°	45°
CUTTING EDGE SHAPE	BALL NOSE	BALL NOSE	CORNER RADIUS	CORNER RADIUS	CORNER RADIUS	SQUARE	SQUARE	SQUARE
SIZE MIN	R3.0	R1.0	D4.0	D2.0	D3.0	D2.0	D3.0	D3.0
SIZE MAX	R10.0	R8.0	D20.0	D20.0	D20.0	D12.0	D20.0	D20.0
PAGE	480	481	482	483	484	485	486	487











	NECK	NECK	NECK	NECK	LONG LENGTH	-	SHORT LENGTH	LONG LENGTH
LENGTH	NECK	NECK	NECK	NECK	LONG LENGTH	-	SHORT LENGTH	LONG LENGTH
SURFACE TREATMENT	Uncoated	Uncoated	Uncoated	Uncoated	Uncoated	Uncoated	Uncoated	Uncoated



Please visit
globalyg1.com/mat
for material search

◎ : Excellent
○ : Good

ISO	VDI 3323	Material Description	HB	HRc	E5910	E5908	E5909	E5930	E5E51	E5E47	E5E48	E5522 E5521	
P	1	Non-alloy steel	125										
	2		190	13									
	3		250	25									
	4		270	28									
	5		300	32									
	6	Low alloy steel	180	10									
	7		275	29									
	8		300	32									
	9		350	38									
	10		High alloyed steel, and tool steel	200	15								
	11	325		35									
M	12	Stainless steel	200	15									
	13		240	23									
	14		180	10									
K	15	Grey cast iron	180	10									
	16		260	26									
	17	Nodular cast iron	160	3									
	18		250	25									
	19		130										
20	Malleable cast iron	230	21					◎	◎	◎	◎		
N	21	Aluminum- wrought alloy	60		◎	◎	◎	◎	◎	◎	◎	◎	
	22		100		◎	◎	◎	◎	◎	◎	◎	◎	
	23	Aluminum-cast, alloyed	75		◎	◎	◎	◎	◎	◎	◎	◎	
	24		90		◎	◎	◎	◎	○	○	○	○	
	25		130		○	○	○	○					
	26		Copper and Copper Alloys	110		○	○	○					
	27		(Bronze / Brass)	90		○	○	○					
	28		100		○	○	○			◎			
	29		Non Metallic Materials Duroplastic, Fiber Reinforced Plastic, Graphite, CFRP, GFRP, etc.										
	30												
S	31	Heat Resistant Super Alloys	200	15									
	32		280	30									
	33		250	25									
	34		350	38									
	35	320	34										
	36	Titanium Alloys	400 Rm										
	37		1050 Rm										
H	38	Hardened steel	550	55									
	39		630	60									
	40	Chilled Cast Iron	400	42									
	41	Hardened Cast Iron	550	55									

Alu-Power						D-Power Graphite						
E5E49	E5E50	E5742 E5711	E5E39 E5E40	EP922 EP923	EP924 EP925	EI997	EIB93	EI880	EI451	EI450	EIB87	
3	3	3	3	3	3	2	2	2	2	2	2	
45°	45°	30°	30°	42°	42°	30°	30°	30°	30°	30°	30°	
SQUARE	SQUARE	ROUGHING	ROUGHING	ROUGHING	ROUGHING	BALL NOSE	BALL NOSE	BALL NOSE	BALL NOSE	BALL NOSE	BALL NOSE	
D3.0	D3.0	D6.0	D6.0	D12.0	D12.0	R0.1	R0.2	R1.0	R1.0	R1.0	R0.5	
D20.0	D20.0	D25.0	D20.0	D28.0	D32.0	R3.0	R2.0	R6.0	R6.0	R6.0	R1.0	
488	489	490	491	492	493	502	504	505	506	507	508	
LONG LENGTH	NECK	LONG LENGTH	NECK	SHORT LENGTH	LONG LENGTH	MINIATURE NECK	MINIATURE NECK	SHORT LENGTH NECK	LONG LENGTH NECK	LONG REACH NECK	TAPER NECK	
Uncoated	Uncoated	Uncoated	Uncoated	TiAIN	TiAIN	Diamond	Diamond	Diamond	Diamond	Diamond	Diamond	
				HSS-PM	HSS-PM							
												
		○	○									1
		○	○									2
		○	○									3
		○	○									4
		○	○									5
		○	○									6 P
		○	○									7
		○	○									8
		○	○									9
		○	○									10
		○	○									11
												12
												13 M
												14
		○	○	○	○							15
		○	○	○	○							16
		○	○	○	○							17 K
		○	○	○	○							18
		○	○	○	○							19
		○	○	○	○							20
◎	◎	◎	◎	◎	◎	○	○	○	○	○	○	21
◎	◎	◎	◎	◎	◎	○	○	○	○	○	○	22
◎	◎	◎	◎	◎	◎	○	○	○	○	○	○	23
◎	◎	◎	◎	◎	◎	○	○	○	○	○	○	24
○	○	○	○	○	○	○	○	○	○	○	○	25 N
												26
												27
												28
						◎	◎	◎	◎	◎	◎	29
												30
												31
												32
												33
												34 S
												35
												36
												37
												38
												39
												40 H
												41

HSS

CBN END MILLS

i-Xmill END MILLS

i-SMART MODULAR END MILLS

X5070 END MILLS

4G MILL END MILLS

X-POWER PRO END MILLS

TitaNox-POWER END MILLS

JET-POWER END MILLS

V7 PLUS END MILLS

ALU-POWER HPC END MILLS

ALU-POWER END MILLS

D-POWER GRAPHITE END MILLS

D-POWER CFRP END MILLS

ROUTERS

CRX S END MILLS

K-2 END MILLS

ONLY ONE COATED PM60 END MILLS

TANK-POWER END MILLS

GENERAL HSS END MILLS

MILLING CUTTERS

TECHNICAL DATA

SELECTION GUIDE



MILLING TOOLS

SERIES
FLUTE
HELIX ANGLE
CUTTING EDGE
SHAPE
SIZE MIN
SIZE MAX
PAGE

D-Power Graphite							
SERIES	EI881	EI996	EIB86	EIA13	EIA14	EIB88	EIB04
FLUTE	3	2	2	3	3	4	2
HELIX ANGLE	30°	30°	30°	40°	40°	30°	30°
CUTTING EDGE SHAPE	BALL NOSE	CORNER RADIUS	CORNER RADIUS	CORNER RADIUS	CORNER RADIUS	CORNER RADIUS	-
SIZE MIN	R1.0	D0.2	D1.0	D2.0	D2.0	D6.0	D0.5
SIZE MAX	R6.0	D6.0	D2.0	D12.0	D12.0	D12.0	D12.0
PAGE	509	510	512	513	514	515	516
LENGTH	SHORT LENGTH NECK	MINIATURE NECK	TAPER NECK	SHORT LENGTH	LONG LENGTH	NECK	LONG LENGTH NECK
SURFACE TREATMENT	Diamond	Diamond	Diamond	Diamond	Diamond	Diamond	Diamond



Please visit globalyg1.com/mat for material search

◎ : Excellent
○ : Good



ISO	VDI 3323	Material Description	HB	HRc							
P	1	Non-alloy steel	125								
	2		190	13							
	3		250	25							
	4		270	28							
	5		300	32							
	6	Low alloy steel	180	10							
	7		275	29							
	8		300	32							
	9		350	38							
	10		High alloyed steel, and tool steel	200	15						
	11	325		35							
M	12	Stainless steel	200	15							
	13		240	23							
	14		180	10							
K	15	Grey cast iron	180	10							
	16		260	26							
	17	Nodular cast iron	160	3							
	18		250	25							
	19		Malleable cast iron	130							
20	230	21									
N	21	Aluminum-wrought alloy	60		○	○	○	○	○	○	○
	22		100		○	○	○	○	○	○	○
	23		75		○	○	○	○	○	○	○
	24	Aluminum-cast, alloyed	90		○	○	○	○	○	○	○
	25		130		○	○	○	○	○	○	○
	26		110								
	27	Copper and Copper Alloys (Bronze / Brass)	90								
	28		100								
	29		Non Metallic Materials <small>Duroplastic, Fiber Reinforced Plastic, Graphite, CFRP, GFRP, etc.</small>			◎	◎	◎	◎	◎	◎
	30										
S	31	Heat Resistant Super Alloys	200	15							
	32		280	30							
	33		250	25							
	34		350	38							
	35	320	34								
	36	Titanium Alloys	400 Rm								
	37		1050 Rm								
H	38	Hardened steel	550	55							
	39		630	60							
	40	Chilled Cast Iron	400	42							
41	Hardened Cast Iron	550	55								

D-Power CFRP		ROUTER	CRX S					K-2			
GUF40	GUF39	RTI104	SGED28	SGED27	SGED29	SGED31	SGED30	G9624	G9A70	G9437	G9438
4, 6, 8 (Multi Flute)	4	-	2	2	2	2	2	2	2	2	2
20° / 20° (DUAL HELIX)	15°	-	30°	30°	30°	30°	30°	30°	30°	≈ 30°	≈ 30°
SQUARE	SQUARE	ROUTER	BALL NOSE	BALL NOSE	CORNER RADIUS	SQUARE	SQUARE	BALL NOSE	BALL NOSE	BALL NOSE	BALL NOSE
D6.0	D6.0	D3.0	R0.5	R0.25	D1.0	D1.0	D0.5	R1.0	R0.5	R1.0	R1.0
D12.0	D12.0	D12.0	R6.0	R6.0	D12.0	D12.0	D12.0	R10.0	R10.0	R10.0	R10.0
522	523	527	531	532	534	536	537	548	549	550	551
-	MINIATURE NECK	-	-	EXTENDED NECK	EXTENDED NECK	-	EXTENDED NECK	SHORT LENGTH	SHORT LENGTH	SHORT LENGTH	LONG LENGTH
Diamond	Diamond	Diamond	DLC	DLC	DLC	DLC	DLC	TiAlN based	TiAlN based	TiAlN based	TiAlN based



								⊙	⊙	⊙	⊙	1
								⊙	⊙	⊙	⊙	2
								⊙	⊙	⊙	⊙	3
								⊙	⊙	⊙	⊙	4
								⊙	⊙	⊙	⊙	5
								⊙	⊙	⊙	⊙	6 P
								⊙	⊙	⊙	⊙	7
								⊙	⊙	⊙	⊙	8
								⊙	⊙	⊙	⊙	9
								⊙	⊙	⊙	⊙	10
								⊙	⊙	⊙	⊙	11
								○	○	○	○	12 M
								○	○	○	○	13
								○	○	○	○	14
								○	○	○	○	15
								○	○	○	○	16
								○	○	○	○	17 K
								○	○	○	○	18
								○	○	○	○	19
								○	○	○	○	20
			○	○	○	○	○	○	○	○	○	21
			○	○	○	○	○	○	○	○	○	22
								○	○	○	○	23
								○	○	○	○	24
			⊙	⊙	⊙	⊙	⊙	○	○	○	○	25 N
			⊙	⊙	⊙	⊙	⊙	○	○	○	○	26
			⊙	⊙	⊙	⊙	⊙	○	○	○	○	27
⊙	⊙	⊙	○	○	○	○	○					28
												29
								○	○	○	○	30
								○	○	○	○	31
								○	○	○	○	32
								○	○	○	○	33
								○	○	○	○	34 S
								○	○	○	○	35
								○	○	○	○	36
								○	○	○	○	37
												38
								○	○	○	○	39 H
												40
												41

HSS

CBN END MILLS

i-Xmill END MILLS

i-SMART MODULAR END MILLS

X5070 END MILLS

4G MILL END MILLS

X-POWER PRO END MILLS

TitaNox-POWER END MILLS

JET-POWER END MILLS

V7 PLUS END MILLS

ALU-POWER HPC END MILLS

ALU-POWER END MILLS

D-POWER GRAPHITE END MILLS

D-POWER CFRP END MILLS

ROUTERS

CRX S END MILLS

K-2 END MILLS

ONLY ONE COATED PM60 END MILLS

TANK-POWER END MILLS

GENERAL HSS END MILLS

MILLING CUTTERS

TECHNICAL DATA

SELECTION GUIDE



MILLING TOOLS

SERIES	K-2								
	G9454	G9455	G9B81	G9634	G9B82	G9B83	G9B84	G9B85	G9424
FLUTE	2	2	2	4	2	2	4	4	2
HELIX ANGLE	30°	30°	30°	30°	30°	30°	30°	30°	30°
CUTTING EDGE SHAPE	BALL NOSE	BALL NOSE	BALL NOSE	BALL NOSE	CORNER RADIUS	CORNER RADIUS	CORNER RADIUS	CORNER RADIUS	SQUARE
SIZE MIN	R1.5	R1.5	R0.2	R1.0	D2.0	D3.0	D2.0	D3.0	D1.0
SIZE MAX	R10.0	R10.0	R2.0	R10.0	D12.0	D12.0	D12.0	D12.0	D20.0
PAGE	552	553	554	556	557	559	560	562	563
LENGTH	LONG REACH	EXTRA LONG LENGTH	RIB PROCESSING	SHORT LENGTH	SHORT LENGTH	LONG REACH	SHORT LENGTH	LONG REACH	SHORT LENGTH
SURFACE TREATMENT	TiAlN based	TiAlN based	TiAlN based	TiAlN based	TiAlN based	TiAlN based	TiAlN based	TiAlN based	TiAlN based

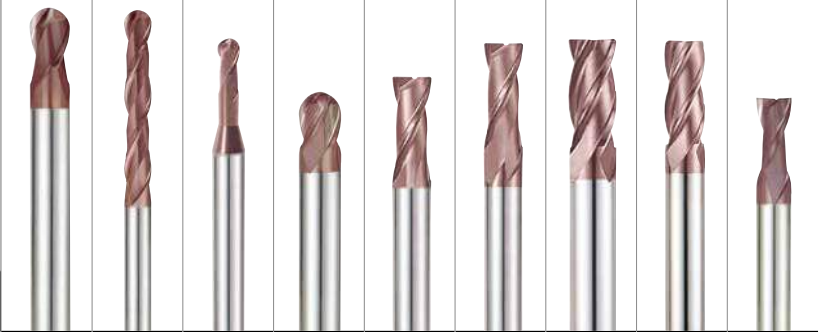

Please visit globalyg1.com/mat for material search

◎ : Excellent
○ : Good

ISO	VDI 3323	Material Description	HB	HRc	G9454	G9455	G9B81	G9634	G9B82	G9B83	G9B84	G9B85	G9424	
P	1	Non-alloy steel	125		◎	◎	◎	◎	◎	◎	◎	◎	◎	
	2		190	13	◎	◎	◎	◎	◎	◎	◎	◎	◎	
	3		250	25	◎	◎	◎	◎	◎	◎	◎	◎	◎	
	4		270	28	◎	◎	◎	◎	◎	◎	◎	◎	◎	
	5		300	32	◎	◎	◎	◎	◎	◎	◎	◎	◎	
	6	Low alloy steel	180	10	◎	◎	◎	◎	◎	◎	◎	◎	◎	
	7		275	29	◎	◎	◎	◎	◎	◎	◎	◎	◎	
	8		300	32	◎	◎	◎	◎	◎	◎	◎	◎	◎	
	9		350	38	◎	◎	◎	◎	◎	◎	◎	◎	◎	
	10		High alloyed steel, and tool steel	200	15	◎	◎	◎	◎	◎	◎	◎	◎	◎
	11	325		35	◎	◎	◎	◎	◎	◎	◎	◎	◎	
M	12	Stainless steel	200	15	○	○	○	○	○	○	○	○	○	
	13		240	23	○	○	○	○	○	○	○	○	○	
	14		180	10	○	○	○	○	○	○	○	○	○	
K	15	Grey cast iron	180	10	○	○	○	○	○	○	○	○	○	
	16		260	26	○	○	○	○	○	○	○	○		
	17	Nodular cast iron	160	3	○	○	○	○	○	○	○	○	○	
	18		250	25	○	○	○	○	○	○	○	○		
	19		130		○	○	○	○	○	○	○	○		
20	Malleable cast iron	230	21	○	○	○	○	○	○	○	○	○		
N	21	Aluminum-wrought alloy	60		○	○	○	○	○	○	○	○	○	
	22		100		○	○	○	○	○	○	○	○		
	23	Aluminum-cast, alloyed	75		○	○	○	○	○	○	○	○	○	
	24		90		○	○	○	○	○	○	○	○		
	25		130		○	○	○	○	○	○	○	○		
	26		Copper and Copper Alloys (Bronze / Brass)	110		○	○	○	○	○	○	○	○	
	27			90		○	○	○	○	○	○	○	○	
	28		100		○	○	○	○	○	○	○	○	○	
	29		Non Metallic Materials Duroplastic, Fiber Reinforced Plastic, Graphite, CFRP, GFRP, etc.							○	○	○	○	○
	30													
S	31	Heat Resistant Super Alloys	200	15	○	○		○					○	
	32		280	30	○	○		○					○	
	33		250	25	○	○		○					○	
	34		350	38	○	○		○					○	
	35	Titanium Alloys	320	34	○	○		○					○	
	36		400 Rm		○	○		○					○	
	37		1050 Rm		○	○		○					○	
H	38	Hardened steel	550	55										
	39		630	60										
	40	Chilled Cast Iron	400	42	○	○		○	○	○	○	○	○	
41	Hardened Cast Iron	550	55											

K-2												
G9G44	G9A68	G9444	G9527	G9445	G9G45	G9452	G9B80	G9553 G9410	G9G46	G9425	G9G47	
2	2	2	2	2	2	2	2	3	3	3	3	
30°	30°	≈ 30°	≈ 30°	≈ 30°	≈ 30°	30°	30°	30°	30°	30°	30°	
SQUARE	SQUARE	SQUARE	SQUARE	SQUARE	SQUARE	SQUARE	SQUARE	SQUARE	SQUARE	SQUARE	SQUARE	
D3.0	D1.0	D2.0	D3.5	D2.0	D3.0	D3.0	D0.4	D0.5	D3.0	D1.0	D3.0	
D20.0	D20.0	D20.0	D20.0	D20.0	D20.0	D20.0	D4.0	D20.0	D20.0	D20.0	D20.0	
564	565	566	567	568	570	571	572	575	577	578	579	
SHORT LENGTH	SHORT LENGTH	SHORT LENGTH	LONG LENGTH	LONG LENGTH	SHORT LENGTH	EXTRA LONG LENGTH	RIB PROCESSING	THROW AWAY	THROW AWAY	SHORT LENGTH	SHORT LENGTH	
TiAIN based	TiAIN based	TiAIN based	TiAIN based	TiAIN based	TiAIN based	TiAIN based	TiAIN based	TiAIN based	TiAIN based	TiAIN based	TiAIN based	
○	○	○	○	○	○	○	○	○	○	○	○	1
○	○	○	○	○	○	○	○	○	○	○	○	2
○	○	○	○	○	○	○	○	○	○	○	○	3
○	○	○	○	○	○	○	○	○	○	○	○	4
○	○	○	○	○	○	○	○	○	○	○	○	5
○	○	○	○	○	○	○	○	○	○	○	○	6 P
○	○	○	○	○	○	○	○	○	○	○	○	7
○	○	○	○	○	○	○	○	○	○	○	○	8
○	○	○	○	○	○	○	○	○	○	○	○	9
○	○	○	○	○	○	○	○	○	○	○	○	10
○	○	○	○	○	○	○	○	○	○	○	○	11
○	○	○	○	○	○	○	○	○	○	○	○	12
○	○	○	○	○	○	○	○	○	○	○	○	13 M
○	○	○	○	○	○	○	○	○	○	○	○	14
○	○	○	○	○	○	○	○	○	○	○	○	15
○	○	○	○	○	○	○	○	○	○	○	○	16
○	○	○	○	○	○	○	○	○	○	○	○	17 K
○	○	○	○	○	○	○	○	○	○	○	○	18
○	○	○	○	○	○	○	○	○	○	○	○	19
○	○	○	○	○	○	○	○	○	○	○	○	20
○	○	○	○	○	○	○	○	○	○	○	○	21
○	○	○	○	○	○	○	○	○	○	○	○	22
○	○	○	○	○	○	○	○	○	○	○	○	23
○	○	○	○	○	○	○	○	○	○	○	○	24
○	○	○	○	○	○	○	○	○	○	○	○	25
○	○	○	○	○	○	○	○	○	○	○	○	26 N
○	○	○	○	○	○	○	○	○	○	○	○	27
○	○	○	○	○	○	○	○	○	○	○	○	28
○	○	○	○	○	○	○	○	○	○	○	○	29
○	○	○	○	○	○	○	○	○	○	○	○	30
○	○	○	○	○	○	○	○	○	○	○	○	31
○	○	○	○	○	○	○	○	○	○	○	○	32
○	○	○	○	○	○	○	○	○	○	○	○	33
○	○	○	○	○	○	○	○	○	○	○	○	34 S
○	○	○	○	○	○	○	○	○	○	○	○	35
○	○	○	○	○	○	○	○	○	○	○	○	36
○	○	○	○	○	○	○	○	○	○	○	○	37
												38
												39
○	○	○	○	○	○	○	○	○	○	○	○	40 H
												41

HSS

CBN
END MILLS

i-Xmill
END MILLS

i-SMART
MODULAR
END MILLS

X5070
END MILLS

4G MILL
END MILLS

X-POWER
PRO
END MILLS

TitaNox-
POWER
END MILLS

JET-POWER
END MILLS

V7 PLUS
END MILLS

ALU-POWER
HPC
END MILLS

ALU-
POWER
END MILLS

D-POWER
GRAPHITE
END MILLS

D-POWER
CFRP
END MILLS

ROUTERS

CRX S
END MILLS

K-2
END MILLS

ONLY ONE
COATED PM60
END MILLS

TANK-
POWER
END MILLS

GENERAL
HSS
END MILLS

MILLING
CUTTERS

TECHNICAL
DATA

SELECTION GUIDE



MILLING TOOLS

SERIES	K-2								
	G9439	G9528	G9433	G9G48	G9447	G9G49	G9432	G9G50	G9A69
FLUTE	3	3	3	3	3	3	4	4	4
HELIX ANGLE	≈ 30°	≈ 30°	≈ 30°	≈ 30°	45°	45°	30°	30°	30°
CUTTING EDGE SHAPE	SQUARE	SQUARE	SQUARE	SQUARE	SQUARE	SQUARE	SQUARE	SQUARE	SQUARE
SIZE MIN	D2.0	D3.5	D3.0	D3.0	D3.0	D3.0	D1.0	D3.0	D1.0
SIZE MAX	D20.0	D20.0	D20.0	D20.0	D20.0	D20.0	D20.0	D20.0	D20.0
PAGE	580	581	582	583	584	585	586	587	588

LENGTH	SHORT LENGTH	LONG LENGTH	LONG LENGTH	LONG LENGTH	LONG LENGTH	LONG LENGTH	SHORT LENGTH	SHORT LENGTH	SHORT LENGTH
SURFACE TREATMENT	TiAlN based	TiAlN based	TiAlN based	TiAlN based	TiAlN based	TiAlN based	TiAlN based	TiAlN based	TiAlN based

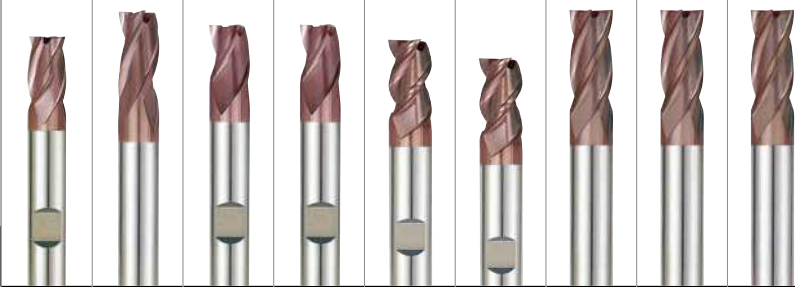

Please visit globalyg1.com/mat for material search

◎ : Excellent
○ : Good

ISO	VDI 3323	Material Description	HB	HRc	G9439	G9528	G9433	G9G48	G9447	G9G49	G9432	G9G50	G9A69	
P	1	Non-alloy steel	125		◎	◎	◎	◎	◎	◎	◎	◎	◎	
	2		190	13	◎	◎	◎	◎	◎	◎	◎	◎	◎	
	3		250	25	◎	◎	◎	◎	◎	◎	◎	◎	◎	
	4		270	28	◎	◎	◎	◎	◎	◎	◎	◎	◎	
	5		300	32	◎	◎	◎	◎	◎	◎	◎	◎	◎	
	6	Low alloy steel	180	10	◎	◎	○	○	○	◎	◎	◎	◎	
	7		275	29	◎	◎	○	○	○	◎	◎	◎	◎	
	8		300	32	◎	◎	○	○	○	◎	◎	◎	◎	
	9		350	38	◎	◎	○	○	○	◎	◎	◎	◎	
	10		High alloyed steel, and tool steel	200	15	◎	◎	○	○	○	◎	◎	◎	◎
	11	325		35	◎	◎	○	○	○	◎	◎	◎	◎	
M	12	Stainless steel	200	15	○	○	○	○	○	○	○	○	○	
	13		240	23	○	○	○	○	○	○	○	○	○	
	14		180	10	○	○	○	○	○	○	○	○	○	
K	15	Grey cast iron	180	10	○	○	○	○	○	○	○	○	○	
	16		260	26	○	○	○	○	○	○	○	○	○	
	17	Nodular cast iron	160	3	○	○	○	○	○	○	○	○	○	
	18		250	25	○	○	○	○	○	○	○	○	○	
	19		130		○	○	○	○	○	○	○	○	○	
20	Malleable cast iron	230	21	○	○	○	○	○	○	○	○	○		
N	21	Aluminum-wrought alloy	60		○	○	○	○	○	○	○	○	○	
	22		100		○	○	○	○	○	○	○	○	○	
	23	Aluminum-cast, alloyed	75		○	○	○	○	○	○	○	○	○	
	24		90		○	○	○	○	○	○	○	○	○	
	25		130		○	○	○	○	○	○	○	○	○	
	26		Copper and Copper Alloys (Bronze / Brass)	110		○	○	○	○	○	○	○	○	○
	27		90		○	○	○	○	○	○	○	○	○	
	28		100		○	○	○	○	○	○	○	○	○	
	29		Non Metallic Materials Duroplastic, Fiber Reinforced Plastic, Graphite, CFRP, GFRP, etc.			○	○	○	○	○	○	○	○	○
	30					○	○	○	○	○	○	○	○	○
S	31	Heat Resistant Super Alloys	200	15	○	○	○	○	○	○	○	○	○	
	32		280	30	○	○	○	○	○	○	○	○	○	
	33		250	25	○	○	○	○	○	○	○	○	○	
	34		350	38	○	○	○	○	○	○	○	○	○	
	35	320	34	○	○	○	○	○	○	○	○	○		
	36	Titanium Alloys	400 Rm		○	○	○	○	○	○	○	○	○	
	37		1050 Rm		○	○	○	○	○	○	○	○	○	
H	38	Hardened steel	550	55										
	39		630	60										
	40	Chilled Cast Iron	400	42	○	○	○	○	○	○	○	○	○	
	41	Hardened Cast Iron	550	55										

SELECTION GUIDE



MILLING TOOLS

SERIES

FLUTE

HELIX ANGLE

CUTTING EDGE SHAPE

SIZE MIN

SIZE MAX

PAGE

LENGTH

SURFACE TREATMENT

Only One

Tank-Power

SERIES	GYG52	GYG76 GYG02	GYF95	GYF94	GYF98	GYG03	E9940 GA940	E9A32 GAA32
FLUTE	4	4	Multi Flute	Multi Flute	Multi Flute	Multi Flute	2	2
HELIX ANGLE	35°/37°	30°	4F: 44°/45° 5F: 44°/44.5°/45°	30°	30°	30°	30°	30°
CUTTING EDGE SHAPE	SQUARE	SQUARE	CORNER RADIUS ROUGHING	ROUGHING	ROUGHING	ROUGHING	BALL NOSE	BALL NOSE
SIZE MIN	D3.0	D2.0	D6.0	D6.0	D6.0	D6.0	R0.5	R1.0
SIZE MAX	D25.0	D25.0	D25.0	D25.0	D25.0	D25.0	R12.5	R12.5
PAGE	622	623	624	625	626	627	640	641
LENGTH	SHORT LENGTH (Center Cut)	LONG LENGTH (Center Cut)	SHORT LENGTH (Center Cut)	SHORT LENGTH (Center Cut)	LONG LENGTH (Center Cut)	SHORT LENGTH (Center Cut)	SHORT LENGTH	LONG LENGTH
SURFACE TREATMENT	Y-Coating	Y-Coating	Y-Coating	Y-Coating	Y-Coating	Y-Coating	TiAlN based	TiAlN based
	PM60	PM60	PM60	PM60	PM60	PM60	HSS-PM	HSS-PM



Please visit
globalyg1.com/mat
for material search

◎ : Excellent
○ : Good

ISO	VDI 3323	Material Description	HB	HRc	GYG52	GYG76 GYG02	GYF95	GYF94	GYF98	GYG03	E9940 GA940	E9A32 GAA32
P	1	Non-alloy steel	125		◎	◎	◎	◎	◎	◎	◎	◎
	2		190	13	◎	◎	◎	◎	◎	◎	◎	◎
	3		250	25	◎	◎	◎	◎	◎	◎	◎	◎
	4		270	28	◎	◎	◎	◎	◎	◎	◎	◎
	5		300	32	◎	◎	◎	◎	◎	◎	◎	◎
	6	Low alloy steel	180	10	◎	◎	◎	◎	◎	◎	◎	◎
	7		275	29	◎	◎	◎	◎	◎	◎	◎	◎
	8		300	32	◎	◎	◎	◎	◎	◎	◎	◎
	9		350	38	○	○	○	○	○	○	○	○
	10		High alloyed steel, and tool steel	200	15	◎	◎	◎	◎	◎	◎	◎
	11	325		35	○	○	○	○	○	○	○	○
M	12	Stainless steel	200	15	◎	◎	◎	◎	◎	◎	◎	◎
	13		240	23	◎	◎	◎	◎	◎	◎	◎	◎
	14		180	10	◎	◎	◎	◎	◎	◎	◎	◎
K	15	Grey cast iron	180	10	◎	◎	◎	◎	◎	◎	◎	◎
	16		260	26	◎	◎	◎	◎	◎	◎	◎	◎
	17	Nodular cast iron	160	3	◎	◎	◎	◎	◎	◎	◎	◎
	18		250	25	◎	◎	◎	◎	◎	◎	◎	◎
	19		130		◎	◎	◎	◎	◎	◎	◎	◎
20	Malleable cast iron	230	21	◎	◎	◎	◎	◎	◎	◎	◎	
N	21	Aluminum- wrought alloy	60									
	22		100									
	23	Aluminum-cast, alloyed	75									
	24		90									
	25		130									
	26		Copper and Copper Alloys (Bronze / Brass)	110		○	○	○	○	○	○	○
	27	90		○	○	○	○	○	○	○	○	○
	28	100		○	○	○	○	○	○	○	○	○
	29	Non Metallic Materials Duroplastic, Fiber Reinforced Plastic, Graphite, CFRP, GFRP, etc.										
	30											
S	31	Heat Resistant Super Alloys	200	15								
	32		280	30								
	33		250	25								
	34		350	38								
	35	320	34									
	36	Titanium Alloys	400 Rm									
	37		1050 Rm									
H	38	Hardened steel	550	55								
	39		630	60								
	40	Chilled Cast Iron	400	42	○	○	○	○	○	○	○	○
	41	Hardened Cast Iron	550	55								

SELECTION GUIDE



MILLING TOOLS

SERIES

FLUTE

HELIX ANGLE

CUTTING EDGE
SHAPE

SIZE MIN

SIZE MAX

PAGE

LENGTH

SURFACE TREATMENT

Tool Material

HSS End mills

	E9410	E9720	E3570	E3574	E3462	E2535	E2492	E2512
SERIES	E9410	E9720	E3570	E3574	E3462	E2535	E2492	E2512
FLUTE	2	Multi Flute	2	4	3	2	2	3
HELIX ANGLE	≈ 30°	30°	≈ 30°	≈ 30°	60°	≈ 30°	≈ 30°	30°
CUTTING EDGE SHAPE	SQUARE	SQUARE	SQUARE	SQUARE	SQUARE	BALL NOSE	BALL NOSE	BALL NOSE
SIZE MIN	D3.0	D6.0	D2.5	D2.0	D7.0	R1.0	R1.0	R1.0
SIZE MAX	D25.0	D30.0	D18.0	D18.0	D20.0	R16.0	R15.0	R3.0
PAGE	678	679	680	681	682	683	684	685

LENGTH	SHORT LENGTH	SHORT LENGTH ROUGHING	SHORT LENGTH	SHORT LENGTH	SHORT LENGTH	SHORT LENGTH	LONG LENGTH	SHORT LENGTH THROW AWAY
SURFACE TREATMENT	Uncoated / TiAIN	Uncoated / TiAIN	Uncoated / TiAIN	Uncoated	Uncoated / TiAIN	Uncoated / TiAIN	Uncoated / TiAIN	Uncoated / TiAIN
Tool Material	HSS-PM	HSS-PM	HSS-PM	HSS-PM	HSS-PM	HSS Co8	HSS Co8	HSS Co8



Please visit globalyg1.com/mat for material search

⊙ : Excellent
○ : Good

ISO	VDI 3323	Material Description	HB	HRc	E9410	E9720	E3570	E3574	E3462	E2535	E2492	E2512
P	1	Non-alloy steel	125		⊙	⊙	⊙	⊙	⊙	⊙	⊙	⊙
	2		190	13	⊙	⊙	⊙	⊙	⊙	⊙	⊙	⊙
	3		250	25	⊙	⊙	⊙	⊙	⊙	⊙	⊙	⊙
	4		270	28	⊙	⊙	⊙	⊙	⊙	⊙	⊙	⊙
	5		300	32	○	○	○	○	○	○	○	○
	6	Low alloy steel	180	10	⊙	⊙	⊙	⊙	⊙	⊙	⊙	⊙
	7		275	29	⊙	⊙	⊙	⊙	⊙	⊙	⊙	⊙
	8		300	32	○	○	○	○	○	○	○	○
	9		350	38	○	○	○	○	○	○	○	○
	10		High alloyed steel, and tool steel	200	15	⊙	⊙	⊙	⊙	⊙	⊙	⊙
	11	325		35	○	○	○	○	○	○	○	○
M	12	Stainless steel	200	15								
	13		240	23								
	14		180	10								
K	15	Grey cast iron	180	10								
	16		260	26								
	17	Nodular cast iron	160	3								
	18		250	25								
	19		130									
20	Malleable cast iron	230	21									
N	21	Aluminum-wrought alloy	60		○	○	○	○	○	○	○	○
	22		100		○	○	○	○	○	○	○	○
	23		75		○	○	○	○	○	○	○	○
	24	Aluminum-cast, alloyed	90		○	○	○	○	○	○	○	○
	25		130		○	○	○	○	○	○	○	○
	26		110									
	27	Copper and Copper Alloys (Bronze / Brass)	90									
	28		100									
	29											
	30	Non Metallic Materials Duroplastic, Fiber Reinforced Plastic, Graphite, CFRP, GFRP, etc.										
S	31	Heat Resistant Super Alloys	200	15								
	32		280	30								
	33		250	25								
	34		350	38								
	35		320	34								
	36	Titanium Alloys	400 Rm									
	37		1050 Rm									
H	38	Hardened steel	550	55								
	39		630	60								
	40	Chilled Cast Iron	400	42								
41	Hardened Cast Iron	550	55									

SELECTION GUIDE



MILLING TOOLS

SERIES

FLUTE

HELIX ANGLE

CUTTING EDGE
SHAPE

SIZE MIN

SIZE MAX

PAGE

LENGTH

SURFACE TREATMENT

HSS End mills

	E2554	E2551	E2552	E2574 E2575	E2595 E2596	E2576 E2577	E2597 E2598	E2776
FLUTE	3	3	3	4&6	4&6	4&6	4&6	Multi Flute
HELIX ANGLE	30°	30°	30°	≈ 30°	≈ 30°	30°	45°	30°
CUTTING EDGE SHAPE	SQUARE	SQUARE	SQUARE	SQUARE	SQUARE	SQUARE	SQUARE	SQUARE
SIZE MIN	D1.5	D1.0	D1.5	D2.0/D21.0	D2.0/D22.0	D2.0/D22.0	D2.0/D22.0	D14.0
SIZE MAX	D10.0	D10.0	D10.0	D20.0 /D40.0	D25.0/D40.0	D20.0/D40.0	D20.0/D40.0	D50.0
PAGE	706	707	708	709	710, 711	712	713, 714	715
LENGTH	LONG LENGTH THROW AWAY	SHORT LENGTH THROW AWAY	LONG LENGTH THROW AWAY	SHORT LENGTH	SHORT LENGTH CENTER CUTTING	LONG LENGTH	LONG LENGTH CENTER CUTTING	SHORT LENGTH
SURFACE TREATMENT	Uncoated / TiAlN	Uncoated / TiAlN	Uncoated / TiAlN	Uncoated / TiAlN	Uncoated / TiAlN	Uncoated / TiAlN	Uncoated / TiAlN	Uncoated / TiAlN
	HSS Co8	HSS Co8	HSS Co8	HSS Co8	HSS Co8	HSS Co8	HSS Co8	HSS Co8



Please visit
globalyg1.com/mat
for material search

◎ : Excellent
○ : Good

ISO	VDI 3323	Material Description	HB	HRc								
P	1	Non-alloy steel	125		◎	◎	◎	◎	◎	◎	◎	◎
	2		190	13	◎	◎	◎	◎	◎	◎	◎	◎
	3		250	25	◎	◎	◎	◎	◎	◎	◎	◎
	4		270	28	◎	◎	◎	◎	◎	◎	◎	◎
	5		300	32	◎	◎	◎	◎	◎	◎	◎	◎
	6	Low alloy steel	180	10	◎	◎	◎	◎	◎	◎	◎	◎
	7		275	29	◎	◎	◎	◎	◎	◎	◎	◎
	8		300	32	◎	◎	◎	◎	◎	◎	◎	◎
	9		350	38	○	○	○	○	○	○	○	○
	10		High alloyed steel, and tool steel	200	15	◎	◎	◎	◎	◎	◎	◎
	11	325		35	○	○	○	○	○	○	○	○
M	12	Stainless steel	200	15								
	13		240	23								
	14		180	10								
K	15	Grey cast iron	180	10								
	16		260	26								
	17	Nodular cast iron	160	3								
	18		250	25								
	19		130									
20	Malleable cast iron	230	21									
N	21	Aluminum- wrought alloy	60		○	○	○	○	○	○	○	○
	22		100		○	○	○	○	○	○	○	○
	23		75		○	○	○	○	○	○	○	○
	24	Aluminum-cast, alloyed	90		○	○	○	○	○	○	○	○
	25		130		○	○	○	○	○	○	○	○
	26		110									
	27	Copper and Copper Alloys (Bronze / Brass)	90									
	28		100									
	29											
	30	Non Metallic Materials Duroplastic, Fiber Reinforced Plastic, Graphite, CFRP, GFRP, etc.										
S	31	Heat Resistant Super Alloys	200	15								
	32		280	30								
	33		250	25								
	34		350	38								
	35	320	34									
	36	Titanium Alloys	400 Rm									
	37		1050 Rm									
H	38	Hardened steel	550	55								
	39		630	60								
	40	Chilled Cast Iron	400	42								
41	Hardened Cast Iron	550	55									

SELECTION GUIDE



MILLING TOOLS

SERIES

FLUTE

HELIX ANGLE

CUTTING EDGE
SHAPE

SIZE MIN

SIZE MAX

PAGE

LENGTH

SURFACE TREATMENT

HSS End mills

	E2778	E2777	E2779	E2766	E2767	E2754	E2768
Multi Flute	Multi Flute	Multi Flute	Multi Flute	3	3	Multi Flute	Multi Flute
30°	30°	30°	30°	30°	30°	30°	30°
SQUARE ROUGHING	SQUARE ROUGHING	SQUARE ROUGHING & FINISHING	SQUARE ROUGHING & FINISHING	SQUARE ROUGHING & FINISHING	SQUARE ROUGHING & FINISHING	SQUARE ROUGHING & FINISHING	SQUARE ROUGHING & FINISHING
D20.0	D14.0	D20.0	D6.0	D6.0	D6.0	D6.0	D6.0
D50.0	D45.0	D45.0	D40.0	D40.0	D40.0	D40.0	D45.0
731	732	733	734	735	736	737	737
SHORT LENGTH	SHORT LENGTH	SHORT LENGTH	SHORT LENGTH	LONG LENGTH	SHORT LENGTH	LONG LENGTH	LONG LENGTH
Uncoated / TiAlN	Uncoated / TiAlN	Uncoated / TiAlN	Uncoated / TiAlN	Uncoated / TiAlN	Uncoated / TiAlN	Uncoated / TiAlN	Uncoated / TiAlN
HSS Co8	HSS Co8	HSS Co8	HSS Co8	HSS Co8	HSS Co8	HSS Co8	HSS Co8



Please visit
globalyg1.com/mat
for material search

◎ : Excellent
○ : Good

ISO	VDI 3323	Material Description	HB	HRc	E2778	E2777	E2779	E2766	E2767	E2754	E2768	
P	1	Non-alloy steel	125		◎	◎	○	◎	◎	◎	◎	
	2		190	13	◎	◎	○	◎	◎	◎	◎	
	3		250	25	◎	◎	◎	◎	◎	◎	◎	
	4		270	28	◎	◎	○	◎	◎	◎	◎	
	5		300	32	◎	◎	○	◎	◎	◎	◎	
	6	Low alloy steel	180	10	○	○		○	○	○	○	
	7		275	29	◎	◎	◎	◎	◎	◎	◎	
	8		300	32	○	○		○	○	○	○	
	9		350	38								
	10		High alloyed steel, and tool steel	200	15							
	11	325		35								
M	12	Stainless steel	200	15								
	13		240	23								
	14		180	10								
K	15	Grey cast iron	180	10								
	16		260	26								
	17	Nodular cast iron	160	3								
	18		250	25	○	○	◎	○	○	○	○	
ROUTERS	19	Malleable cast iron	130		○	○	◎	○	○	○	○	
	20		230	21	○	○	◎	○	○	○	○	
N	21	Aluminum- wrought alloy	60		○	○	◎	○	○	○	○	
	22		100		○	○	○	○	○	○	○	
	23		75									
	24	Aluminum-cast, alloyed	90									
	25		130									
	26		110									
	27	Copper and Copper Alloys (Bronze / Brass)	90									
	28		100									
	29		Non Metallic Materials Duroplastic, Fiber Reinforced Plastic, Graphite, CFRP, GFRP, etc.									
	30											
S	31	Heat Resistant Super Alloys	200	15								
	32		280	30								
	33		250	25								
	34		350	38								
	35		320	34								
	36	Titanium Alloys	400 Rm									
	37		1050 Rm									
H	38	Hardened steel	550	55								
	39		630	60								
	40	Chilled Cast Iron	400	42								
41	Hardened Cast Iron	550	55									

Milling Cutting

ML012, ML022 ML112, ML122 ML212, ML222	ML032, ML042 ML132, ML142 ML232, ML242	ML062 ML162 ML262	ML072 ML172 ML272	ML092	ML102	E2675	E2676	E2677	E2678	E2679	E2498
-	-	-	-	-	-	Multi Flute	Multi Flute	Multi Flute	Multi Flute	Multi Flute	4
0°	0°	10°-20°	10°-20°	10°	-	30°	42°	30°	30°	30°	0°
DOVETAIL CUTTERS	DOVETAIL CUTTERS	WOODRUFF KEYSEAT CUTTERS	T-SLOT CUTTERS	SIDE AND FACE MILLING CUTTERS	SIDE AND FACE MILLING CUTTERS	SHELL END MILL	SHELL END MILL	ROUGHING SHELL END MILL	ROUGHING SHELL END MILL	ROUGHING & FINISHING SHELL END MILL	CORNER ROUNDING CUTTERS
D16.0	D16.0	D10.5	D12.5	D50.0	D50.0	D30.0	D30.0	D40.0	D40.0	D40.0	D8.0
D50.0	D38.0	D45.5	D40.0	D125.0	D200.0	D160.0	D100.0	D160.0	D160.0	D160.0	D56.0
792	793	794	796	797	799	805	806	807	808	809	810
Type A, C, E	Type B, D, F	Type B, D, F	Type AA, AB, AD	with STRAIGHT TEETH	with STAGGERED TEETH	-	for ALUMINUM	-	-	-	-
Uncoated	Uncoated	Uncoated	Uncoated	Uncoated	Uncoated	Uncoated	Uncoated	Uncoated	Uncoated	Uncoated	Uncoated
HSS-E	HSS-E	HSS-E	HSS-E	HSS-E	HSS-E	HSS Co8	HSS Co8	HSS Co8	HSS Co8	HSS Co8	HSS Co8
<input checked="" type="radio"/>	<input checked="" type="radio"/>	<input checked="" type="radio"/>	<input checked="" type="radio"/>	<input checked="" type="radio"/>	<input checked="" type="radio"/>	<input checked="" type="radio"/>	<input type="radio"/>	<input checked="" type="radio"/>	<input checked="" type="radio"/>	<input checked="" type="radio"/>	<input checked="" type="radio"/>
<input type="radio"/>	<input checked="" type="radio"/>	<input checked="" type="radio"/>	<input checked="" type="radio"/>	<input checked="" type="radio"/>	<input checked="" type="radio"/>	<input checked="" type="radio"/>	<input type="radio"/>	<input checked="" type="radio"/>	<input checked="" type="radio"/>	<input checked="" type="radio"/>	<input checked="" type="radio"/>
<input type="radio"/>	<input type="radio"/>	<input checked="" type="radio"/>	<input checked="" type="radio"/>	<input checked="" type="radio"/>	<input checked="" type="radio"/>	<input checked="" type="radio"/>	<input type="radio"/>	<input checked="" type="radio"/>	<input checked="" type="radio"/>	<input checked="" type="radio"/>	<input checked="" type="radio"/>
<input type="radio"/>	<input type="radio"/>	<input type="radio"/>	<input checked="" type="radio"/>	<input checked="" type="radio"/>	<input checked="" type="radio"/>	<input checked="" type="radio"/>	<input type="radio"/>	<input checked="" type="radio"/>	<input checked="" type="radio"/>	<input checked="" type="radio"/>	<input checked="" type="radio"/>
<input type="radio"/>	<input type="radio"/>	<input type="radio"/>	<input type="radio"/>	<input checked="" type="radio"/>	<input checked="" type="radio"/>	<input checked="" type="radio"/>	<input type="radio"/>	<input checked="" type="radio"/>	<input checked="" type="radio"/>	<input checked="" type="radio"/>	<input checked="" type="radio"/>
<input type="radio"/>	<input type="radio"/>	<input type="radio"/>	<input type="radio"/>	<input type="radio"/>	<input checked="" type="radio"/>	<input checked="" type="radio"/>	<input type="radio"/>	<input checked="" type="radio"/>	<input checked="" type="radio"/>	<input checked="" type="radio"/>	<input checked="" type="radio"/>
<input type="radio"/>	<input type="radio"/>	<input type="radio"/>	<input type="radio"/>	<input type="radio"/>	<input type="radio"/>	<input type="radio"/>	<input type="radio"/>	<input checked="" type="radio"/>	<input type="radio"/>	<input checked="" type="radio"/>	<input checked="" type="radio"/>
<input type="radio"/>	<input type="radio"/>	<input type="radio"/>	<input type="radio"/>	<input type="radio"/>	<input type="radio"/>	<input type="radio"/>	<input type="radio"/>	<input type="radio"/>	<input type="radio"/>	<input type="radio"/>	<input type="radio"/>
<input type="radio"/>	<input type="radio"/>	<input type="radio"/>	<input type="radio"/>	<input type="radio"/>	<input type="radio"/>	<input type="radio"/>	<input type="radio"/>	<input type="radio"/>	<input type="radio"/>	<input type="radio"/>	<input type="radio"/>
<input type="radio"/>	<input type="radio"/>	<input type="radio"/>	<input type="radio"/>	<input type="radio"/>	<input type="radio"/>	<input type="radio"/>	<input type="radio"/>	<input type="radio"/>	<input type="radio"/>	<input type="radio"/>	<input type="radio"/>
<input type="radio"/>	<input type="radio"/>	<input type="radio"/>	<input type="radio"/>	<input type="radio"/>	<input type="radio"/>	<input type="radio"/>	<input type="radio"/>	<input type="radio"/>	<input type="radio"/>	<input type="radio"/>	<input type="radio"/>
<input type="radio"/>	<input type="radio"/>	<input type="radio"/>	<input type="radio"/>	<input type="radio"/>	<input type="radio"/>	<input type="radio"/>	<input type="radio"/>	<input type="radio"/>	<input type="radio"/>	<input type="radio"/>	<input type="radio"/>
<input type="radio"/>	<input type="radio"/>	<input type="radio"/>	<input type="radio"/>	<input type="radio"/>	<input type="radio"/>	<input type="radio"/>	<input type="radio"/>	<input type="radio"/>	<input type="radio"/>	<input type="radio"/>	<input type="radio"/>
<input type="radio"/>	<input type="radio"/>	<input type="radio"/>	<input type="radio"/>	<input type="radio"/>	<input type="radio"/>	<input type="radio"/>	<input type="radio"/>	<input type="radio"/>	<input type="radio"/>	<input type="radio"/>	<input type="radio"/>
<input type="radio"/>	<input type="radio"/>	<input type="radio"/>	<input type="radio"/>	<input type="radio"/>	<input type="radio"/>	<input type="radio"/>	<input type="radio"/>	<input type="radio"/>	<input type="radio"/>	<input type="radio"/>	<input type="radio"/>
<input type="radio"/>	<input type="radio"/>	<input type="radio"/>	<input type="radio"/>	<input type="radio"/>	<input type="radio"/>	<input type="radio"/>	<input type="radio"/>	<input type="radio"/>	<input type="radio"/>	<input type="radio"/>	<input type="radio"/>
<input type="radio"/>	<input type="radio"/>	<input type="radio"/>	<input type="radio"/>	<input type="radio"/>	<input type="radio"/>	<input type="radio"/>	<input type="radio"/>	<input type="radio"/>	<input type="radio"/>	<input type="radio"/>	<input type="radio"/>
<input type="radio"/>	<input type="radio"/>	<input type="radio"/>	<input type="radio"/>	<input type="radio"/>	<input type="radio"/>	<input type="radio"/>	<input type="radio"/>	<input type="radio"/>	<input type="radio"/>	<input type="radio"/>	<input type="radio"/>
<input type="radio"/>	<input type="radio"/>	<input type="radio"/>	<input type="radio"/>	<input type="radio"/>	<input type="radio"/>	<input type="radio"/>	<input type="radio"/>	<input type="radio"/>	<input type="radio"/>	<input type="radio"/>	<input type="radio"/>
<input type="radio"/>	<input type="radio"/>	<input type="radio"/>	<input type="radio"/>	<input type="radio"/>	<input type="radio"/>	<input type="radio"/>	<input type="radio"/>	<input type="radio"/>	<input type="radio"/>	<input type="radio"/>	<input type="radio"/>
<input type="radio"/>	<input type="radio"/>	<input type="radio"/>	<input type="radio"/>	<input type="radio"/>	<input type="radio"/>	<input type="radio"/>	<input type="radio"/>	<input type="radio"/>	<input type="radio"/>	<input type="radio"/>	<input type="radio"/>
<input type="radio"/>	<input type="radio"/>	<input type="radio"/>	<input type="radio"/>	<input type="radio"/>	<input type="radio"/>	<input type="radio"/>	<input type="radio"/>	<input type="radio"/>	<input type="radio"/>	<input type="radio"/>	<input type="radio"/>
<input type="radio"/>	<input type="radio"/>	<input type="radio"/>	<input type="radio"/>	<input type="radio"/>	<input type="radio"/>	<input type="radio"/>	<input type="radio"/>	<input type="radio"/>	<input type="radio"/>	<input type="radio"/>	<input type="radio"/>
<input type="radio"/>	<input type="radio"/>	<input type="radio"/>	<input type="radio"/>	<input type="radio"/>	<input type="radio"/>	<input type="radio"/>	<input type="radio"/>	<input type="radio"/>	<input type="radio"/>	<input type="radio"/>	<input type="radio"/>
<input type="radio"/>	<input type="radio"/>	<input type="radio"/>	<input type="radio"/>	<input type="radio"/>	<input type="radio"/>	<input type="radio"/>	<input type="radio"/>	<input type="radio"/>	<input type="radio"/>	<input type="radio"/>	<input type="radio"/>
<input type="radio"/>	<input type="radio"/>	<input type="radio"/>	<input type="radio"/>	<input type="radio"/>	<input type="radio"/>	<input type="radio"/>	<input type="radio"/>	<input type="radio"/>	<input type="radio"/>	<input type="radio"/>	<input type="radio"/>
<input type="radio"/>	<input type="radio"/>	<input type="radio"/>	<input type="radio"/>	<input type="radio"/>	<input type="radio"/>	<input type="radio"/>	<input type="radio"/>	<input type="radio"/>	<input type="radio"/>	<input type="radio"/>	<input type="radio"/>
<input type="radio"/>	<input type="radio"/>	<input type="radio"/>	<input type="radio"/>	<input type="radio"/>	<input type="radio"/>	<input type="radio"/>	<input type="radio"/>	<input type="radio"/>	<input type="radio"/>	<input type="radio"/>	<input type="radio"/>
<input type="radio"/>	<input type="radio"/>	<input type="radio"/>	<input type="radio"/>	<input type="radio"/>	<input type="radio"/>	<input type="radio"/>	<input type="radio"/>	<input type="radio"/>	<input type="radio"/>	<input type="radio"/>	<input type="radio"/>
<input type="radio"/>	<input type="radio"/>	<input type="radio"/>	<input type="radio"/>	<input type="radio"/>	<input type="radio"/>	<input type="radio"/>	<input type="radio"/>	<input type="radio"/>	<input type="radio"/>	<input type="radio"/>	<input type="radio"/>
<input type="radio"/>	<input type="radio"/>	<input type="radio"/>	<input type="radio"/>	<input type="radio"/>	<input type="radio"/>	<input type="radio"/>	<input type="radio"/>	<input type="radio"/>	<input type="radio"/>	<input type="radio"/>	<input type="radio"/>
<input type="radio"/>	<input type="radio"/>	<input type="radio"/>	<input type="radio"/>	<input type="radio"/>	<input type="radio"/>	<input type="radio"/>	<input type="radio"/>	<input type="radio"/>	<input type="radio"/>	<input type="radio"/>	<input type="radio"/>
<input type="radio"/>	<input type="radio"/>	<input type="radio"/>	<input type="radio"/>	<input type="radio"/>	<input type="radio"/>	<input type="radio"/>	<input type="radio"/>	<input type="radio"/>	<input type="radio"/>	<input type="radio"/>	<input type="radio"/>
<input type="radio"/>	<input type="radio"/>	<input type="radio"/>	<input type="radio"/>	<input type="radio"/>	<input type="radio"/>	<input type="radio"/>	<input type="radio"/>	<input type="radio"/>	<input type="radio"/>	<input type="radio"/>	<input type="radio"/>
<input type="radio"/>	<input type="radio"/>	<input type="radio"/>	<input type="radio"/>	<input type="radio"/>	<input type="radio"/>	<input type="radio"/>	<input type="radio"/>	<input type="radio"/>	<input type="radio"/>	<input type="radio"/>	<input type="radio"/>
<input type="radio"/>	<input type="radio"/>	<input type="radio"/>	<input type="radio"/>	<input type="radio"/>	<input type="radio"/>	<input type="radio"/>	<input type="radio"/>	<input type="radio"/>	<input type="radio"/>	<input type="radio"/>	<input type="radio"/>
<input type="radio"/>	<input type="radio"/>	<input type="radio"/>	<input type="radio"/>	<input type="radio"/>	<input type="radio"/>	<input type="radio"/>	<input type="radio"/>	<input type="radio"/>	<input type="radio"/>	<input type="radio"/>	<input type="radio"/>
<input type="radio"/>	<input type="radio"/>	<input type="radio"/>	<input type="radio"/>	<input type="radio"/>	<input type="radio"/>	<input type="radio"/>	<input type="radio"/>	<input type="radio"/>	<input type="radio"/>	<input type="radio"/>	<input type="radio"/>
<input type="radio"/>	<input type="radio"/>	<input type="radio"/>	<input type="radio"/>	<input type="radio"/>	<input type="radio"/>	<input type="radio"/>	<input type="radio"/>	<input type="radio"/>	<input type="radio"/>	<input type="radio"/>	<input type="radio"/>
<input type="radio"/>	<input type="radio"/>	<input type="radio"/>	<input type="radio"/>	<input type="radio"/>	<input type="radio"/>	<input type="radio"/>	<input type="radio"/>	<input type="radio"/>	<input type="radio"/>	<input type="radio"/>	<input type="radio"/>
<input type="radio"/>	<input type="radio"/>	<input type="radio"/>	<input type="radio"/>	<input type="radio"/>	<input type="radio"/>	<input type="radio"/>	<input type="radio"/>	<input type="radio"/>	<input type="radio"/>	<input type="radio"/>	<input type="radio"/>
<input type="radio"/>	<input type="radio"/>	<input type="radio"/>	<input type="radio"/>	<input type="radio"/>	<input type="radio"/>	<input type="radio"/>	<input type="radio"/>	<input type="radio"/>	<input type="radio"/>	<input type="radio"/>	<input type="radio"/>

HSS

CBN
END MILLS

i-Xmill
END MILLS

i-SMART
MODULAR
END MILLS

X5070
END MILLS

4G MILL
END MILLS

X-POWER
PRO
END MILLS

TitaNox-
POWER
END MILLS

JET-POWER
END MILLS

V7 PLUS
END MILLS

ALU-POWER
HPC
END MILLS

ALU-
POWER
END MILLS

D-POWER
GRAPHITE
END MILLS

D-POWER
CFRP
END MILLS

ROUTERS

CRX S
END MILLS

K-2
END MILLS

ONLY ONE
COATED PM60
END MILLS

TANK-
POWER
END MILLS

GENERAL
HSS
END MILLS

MILLING
CUTTERS

TECHNICAL
DATA



Global Cutting Tool Leader **YG-1**



MILLING



Leading Through Innovation



CBN

CBN (Cubic Boron Nitride)

CBN FRÄSER

- CBN(Cubic Boron Nitride) Machining High Hardened Steels up to HRc70
Mirror Finish
- CBN (Kubisches Bornitrid) zur Bearbeitung von hochgehärteten Stählen bis HRc70
Hochglanzoberfläche

SELECTION GUIDE



SERIES	ESB94	ESD02
FLUTE	2	2
HELIX ANGLE	30°	0°
CUTTING EDGE SHAPE	BALL NOSE	CORNER RADIUS
SIZE MIN	R0.2	D0.5
SIZE MAX	R1.5	D2.0
PAGE	51	52

CBN END MILLS

Cubic Boron Nitride,
Machining High Hardened Steels
up to HRc70, Mirror Finish

◎ : Excellent ○ : Good

Recommended cutting conditions : P 53



ISO	VDI 3323	Material Description	Composition / Structure / Heat Treatment	HB	HRc		
P	1	Non-alloy steel	About 0.15% C Annealed	125			
	2		About 0.45% C Annealed	190	13		
	3		About 0.45% C Quenched & Tempered	250	25		
	4		About 0.75% C Annealed	270	28		
	5		About 0.75% C Quenched & Tempered	300	32		
	6	Low alloy steel	Annealed	180	10		
	7		Quenched & Tempered	275	29		
	8		Quenched & Tempered	300	32		
	9		Quenched & Tempered	350	38		
	10		High alloyed steel, and tool steel	Annealed	200	15	
	11	Quenched & Tempered		325	35		
M	12	Stainless steel	Ferritic / Martensitic Annealed	200	15		
	13		Martensitic Quenched & Tempered	240	23		
	14		Austenitic	180	10		
K	15	Grey cast iron	Pearlitic / ferritic	180	10		
	16		Pearlitic (Martensitic)	260	26		
	17	Nodular cast iron	Ferritic	160	3		
	18		Pearlitic	250	25		
	19		Ferritic	130			
20	Malleable cast iron	Pearlitic	230	21			
N	21	Aluminum-wrought alloy	Not Curable	60			
	22		Curable Hardened	100			
	23	Aluminum-cast, alloyed	≤ 12% Si, Not Curable	75			
	24		≤ 12% Si, Curable Hardened	90			
	25		> 12% Si, Not Curable	130			
	26	Copper and Copper Alloys (Bronze / Brass)	Cutting Alloys, PB>1%	110			
	27		CuZn, CuSnZn (Brass)	90			
	28		CuSn, lead-free copper and electrolytic copper	100			
	29	Non Metallic Materials	Duroplastic, Fiber Reinforced Plastic				
	30		Rubber, Wood, etc.				
S	31	Heat Resistant Super Alloys	Fe Based Annealed	200	15		
	32		Cured	280	30		
	33		Annealed	250	25		
	34		Ni or Co Based Cured	350	38		
	35		Cast	320	34		
	36	Titanium Alloys	Pure Titanium	400 Rm			
	37		Alpha + Beta Alloys Hardened	1050 Rm			
H	38	Hardened steel	Hardened	550	55	◎	◎
	39		Hardened	630	60	◎	◎
	40	Chilled Cast Iron	Cast	400	42		
	41	Hardened Cast Iron	Hardened	550	55	◎	◎

CBN, 2 FLUTE BALL NOSE

- CBN, 2 SCHNEIDEN STIRNRADIUS
- CBN, fraise 2 dents, hémisphérique
- CBN, 2 TAGLIENTI, SEMISFERICA

- ▶ Achieves stable machining and higher accuracy for duration.
- ▶ Saves setting time and cost from the reduction of frequent tool change.
- ▶ Improves repeatability in performance.
- ▶ Special designed geometry improving tool rigidity at High Speed Cutting.
- ▶ Tighter Radius Tolerance of $\pm 0.005\text{mm}$ and higher accuracy with longer tool life.

- ▶ Sichert dauerhaft stabile Bearbeitung und höhere Genauigkeit.
- ▶ Spart Rüstzeit und -kosten durch weniger Werkzeugwechsel.
- ▶ Verbessert die Wiederholgenauigkeit.
- ▶ Eine besondere Werkzeuggeometrie verbessert die Steifigkeit bei HSC-Bearbeitung.
- ▶ Engere Radiustoleranz ± 0.005 , höhere Genauigkeit und längere Werkzeuglebenszeit.

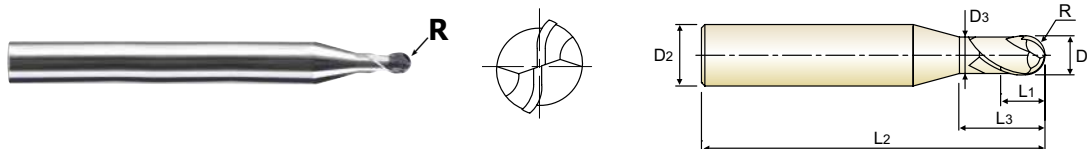

Unit : mm

EDP No.	Radius of Ball Nose	Mill Diameter	Shank Diameter	Length of Cut	Length Below Shank	Overall Length	Neck Diameter
	R (± 0.005)	D1	D2	L1	L3	L2	D3
ESB94004012	R0.2	0.4	4	0.3	1.2	50	0.37
ESB94005015	R0.25	0.5	4	0.4	1.5	50	0.46
ESB94006015	R0.3	0.6	4	0.5	1.5	50	0.56
ESB94008020	R0.4	0.8	4	0.6	2	50	0.76
ESB94010025	R0.5	1.0	4	0.6	2.5	50	0.95
ESB94010040	R0.5	1.0	4	0.6	4	50	0.95
ESB94010060	R0.5	1.0	4	0.6	6	50	0.95
ESB94012030	R0.6	1.2	4	0.8	3	50	1.15
ESB94015030	R0.75	1.5	4	0.95	3	50	1.45
ESB94015040	R0.75	1.5	4	0.95	4	50	1.45
ESB94015060	R0.75	1.5	4	0.95	6	50	1.45
ESB94020050	R1.0	2.0	4	1.2	5	50	1.95
ESB94020060	R1.0	2.0	4	1.2	6	50	1.95
ESB94030060	R1.5	3.0	4	1.8	6	50	2.85

Radius Tolerance(Mm)	Shank Dia. Tolerance
± 0.005	h5

◎ : Excellent ○ : Good

ISO Material Description	P										M				K						
	Non-alloy steel					Low alloy steel					High alloyed steel, and tool steel		Stainless steel		Grey cast iron		Nodular cast iron		Malleable cast iron		
VDI 3323	1	2	3	4	5	6	7	8	9	10	11	12	13	14	15	16	17	18	19	20	
HRC		13	25	28	32	10	29	32	38	15	35	15	23	10	10	26	3	25	42	55	
HB	125	190	250	270	300	180	275	300	350	200	325	200	240	180	180	260	160	250	130	230	
Recommend																					
ISO Material Description	N					S					H										
	Aluminum-wrought alloy		Aluminum-cast, alloyed			Copper and Copper Alloys (Bronze / Brass)		Non Metallic Materials			Heat Resistant Super Alloys					Titanium Alloys		Hardened steel	Chilled Cast Iron	Hardened Cast Iron	
VDI 3323	21	22	23	24	25	26	27	28	29	30	31	32	33	34	35	36	37	38	39	40	41
HRC											15	30	25	38	34			55	60	42	55
HB	60	100	75	90	130	110	90	100			200	280	250	350	320	400 Rm	1050 Rm	550	630	400	550
Recommend																		◎	◎		◎

CBN, 2 FLUTE CORNER RADIUS

- CBN, 2 SCHNEIDEN ECKENRADIUS
- CBN, fraise 2 dents, torique
- CBN, 2 TAGLIENTI, TORICA

- ▶ Achieves stable machining and higher accuracy for duration.
- ▶ Saves setting time and cost from the reduction of frequent tool change.
- ▶ Improves repeatability in performance.
- ▶ Special designed geometry improving tool rigidity at High Speed Cutting.
- ▶ Tighter Radius Tolerance of $\pm 0.005\text{mm}$ and higher accuracy with longer tool life.

- ▶ **Sichert dauerhaft stabile Bearbeitung und höhere Genauigkeit.**
- ▶ **Spart Rüstzeit und -kosten durch weniger Werkzeugwechsel.**
- ▶ **Verbessert die Wiederholgenauigkeit.**
- ▶ **Eine besondere Werkzeuggeometrie verbessert die Steifigkeit bei HSC-Bearbeitung.**
- ▶ **Engere Radiustoleranz ± 0.005 , höhere Genauigkeit und längere Werkzeuglebenszeit.**

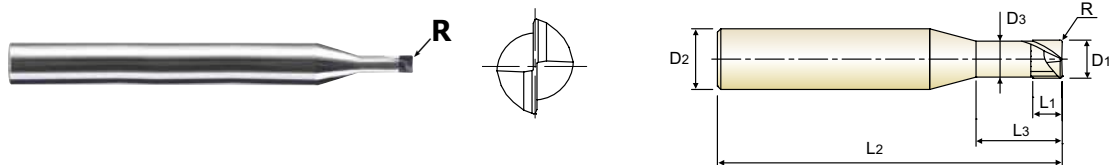

Unit : mm

EDP No.	Corner Radius	Mill Diameter	Shank Diameter	Length of Cut	Length Below Shank	Overall Length	Neck Diameter
	R (± 0.005)	D1	D2	L1	L3	L2	D3
ESD02005052	R0.05	0.5	4	0.3	2	50	0.46
ESD02005053	R0.05	0.5	4	0.3	3	50	0.46
ESD02010053	R0.05	1.0	4	0.7	3	50	0.95
ESD02010055	R0.05	1.0	4	0.7	5	50	0.95
ESD02010103	R0.1	1.0	4	0.7	3	50	0.95
ESD02010105	R0.1	1.0	4	0.7	5	50	0.95
ESD02015105	R0.1	1.5	4	1.0	5	50	1.45
ESD02015108	R0.1	1.5	4	1.0	8	50	1.45
ESD02015205	R0.2	1.5	4	1.0	5	50	1.45
ESD02015208	R0.2	1.5	4	1.0	8	50	1.45
ESD02020106	R0.1	2.0	4	1.2	6	50	1.95
ESD02020100	R0.1	2.0	4	1.2	10	50	1.95
ESD02020206	R0.2	2.0	4	1.2	6	50	1.95
ESD02020200	R0.2	2.0	4	1.2	10	50	1.95

Corner Radius(mm)	Shank Dia. Tolerance
± 0.005	h5

◎ : Excellent ○ : Good

ISO Material Description	P										M				K							
	Non-alloy steel					Low alloy steel					High alloyed steel, and tool steel				Stainless steel				Grey cast iron		Nodular cast iron	
VDI 3323	1	2	3	4	5	6	7	8	9	10	11	12	13	14	15	16	17	18	19	20		
HRc	13	25	28	32	30	10	29	32	38	15	35	15	23	10	10	26	3	25		21		
HB	125	190	250	270	300	180	275	300	350	200	325	200	240	180	180	260	160	250	130	230		
Recommend																						
ISO Material Description	N					S					H											
	Aluminum-wrought alloy		Aluminum-cast, alloyed			Copper and Copper Alloys (Bronze / Brass)		Non Metallic Materials			Heat Resistant Super Alloys					Titanium Alloys		Hardened steel	Chilled Cast Iron	Hardened Cast Iron		
VDI 3323	21	22	23	24	25	26	27	28	29	30	31	32	33	34	35	36	37	38	39	40	41	
HRc											15	30	25	38	34			55	60	42	55	
HB	60	100	75	90	130	110	90	100			200	280	250	350	320	400 Rm	1050 Rm	550	630	400	550	
Recommend																		◎	◎		◎	

ESB94 SERIES

2 FLUTE BALL NOSE

Vc = m/min.
fz = mm/tooth
RPM = rev./min.
FEED = mm/min.

ISO	VDI 3323	Material Description	Ae	Ap	Parameter	Diameter (Ø)								
						0.4	0.5	0.6	0.8	1.0	1.2	1.5	2.0	3.0
H	38	Hardened steel	0.5D	0.2R	Vc	65	80	95	125	155	190	235	250	250
					fz	0.012	0.015	0.02	0.02	0.03	0.03	0.04	0.04	
					RPM	51725	50930	50399	49736	49338	50399	49869	39789	26526
					FEED	1241	1528	2016	1989	2960	3024	2992	3183	2122
	39.1		0.5D	0.1R	Vc	65	80	95	125	155	190	235	250	250
					fz	0.012	0.015	0.02	0.02	0.03	0.03	0.04	0.04	
					RPM	51725	50930	50399	49736	49338	50399	49869	39789	26526
					FEED	1241	1528	2016	1989	2960	3024	2992	3183	2122
	39.2		0.5D	0.1R	Vc	65	80	95	125	155	190	235	200	205
					fz	0.012	0.015	0.02	0.02	0.03	0.03	0.039	0.04	
					RPM	51725	50930	50399	49736	49338	50399	49869	31831	21751
					FEED	1241	1528	2016	1989	2960	3024	2992	2483	1740
	39.3		R0.2~R0.4 = 0.005mm R0.5~R1.5 = 0.01mm	R0.2~R0.4 = 0.005mm R0.5~R1.5 = 0.01mm	Vc	65	80	95	125	155	190	235	200	205
					fz	0.012	0.015	0.02	0.02	0.03	0.03	0.039	0.04	
					RPM	51725	50930	50399	49736	49338	50399	49869	31831	21751
					FEED	1241	1528	2016	1989	2960	3024	2992	2483	1740
41	Hardened Cast Iron	0.5D	0.2R	Vc	65	80	95	125	155	190	235	250	250	
				fz	0.012	0.015	0.02	0.02	0.03	0.03	0.04	0.04		
				RPM	51725	50930	50399	49736	49338	50399	49869	39789	26526	
				FEED	1241	1528	2016	1989	2960	3024	2992	3183	2122	

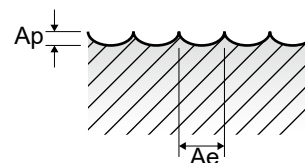

ESD02 SERIES

2 FLUTE CORNER RADIUS

ISO	VDI 3323	Material Description	Parameter	Diameter (Ø)				
				0.5	1.0	1.5	2.0	
H	38 39.1	Hardened steel	Vc	80	135	140	140	
			fz	0.007	0.012	0.017	0.02	
			RPM	50930	42972	29709	22282	
			FEED	713	1031	1010	891	
	39.2 39.3		Ae	0.1	0.2	0.4	0.6	
				Ap	0.01	0.01	0.02	0.03
				Vc	80	95	90	90
				fz	0.006	0.012	0.018	0.029
	41		Hardened Cast Iron	RPM	50930	30239	19099	14324
				FEED	611	726	688	831
				Ae	0.06	0.1	0.2	0.3
				Ap	0.005	0.01	0.02	0.03
	41		Hardened Cast Iron	Vc	80	135	140	140
				fz	0.007	0.012	0.017	0.02
				RPM	50930	42972	29709	22282
				FEED	713	1031	1010	891
41	Hardened Cast Iron	Ae	0.1	0.2	0.4	0.6		
		Ap	0.01	0.01	0.02	0.03		

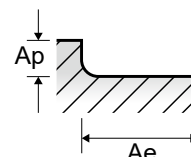



Global Cutting Tool Leader **YG-1**



MILLING



Leading Through Innovation



CARBIDE INSERT & HOLDER

i-Xmill END MILLS

i-Xmills, HM-Wendeplatten Fräser

- Various Applications Type of Inserts Available for General Steels, Pre-Hardened Steels, High Hardened Steels, Stainless Steels and Graphite
- Für die verschiedensten Anwendungen sind Wendeplatten verfügbar, für allgemeine Stähle, vorgehärtete Stähle, hochgehärtete Stähle, rostfreie Stähle und Graphit

SELECTION GUIDE



SERIES	XMB110A	XMB120C	XMB260T	XMB130A
FLUTE	2	2	2	2
HELIX ANGLE	-	-	-	-
CUTTING EDGE SHAPE	BALL NOSE	BALL NOSE	BALL NOSE	BALL NOSE
SIZE MIN	R4.0	R4.0	R4.0	R4.0
SIZE MAX	R16.5	R16.5	R16.5	R16.5
PAGE	58	58	58	59

CARBIDE INSERT & HOLDER *i-Xmill*
END MILLS

Available for General Steels, Pre-Hardened Steels, High Hardened Steels, Stainless Steel and Graphite













Please visit globalyg1.com/mat for material search

◎ : Excellent ○ : Good

Recommended cutting conditions : P 75



ISO	VDI 3323	Material Description	Composition / Structure / Heat Treatment	HB	HRc	AITiN	X-Coating	Z-Coating	AITiN
P	1	Non-alloy steel	About 0.15% C Annealed	125		◎			
	2		About 0.45% C Annealed	190	13	◎			
	3		About 0.45% C Quenched & Tempered	250	25	◎			
	4		About 0.75% C Annealed	270	28	◎			
	5		About 0.75% C Quenched & Tempered	300	32	◎			
	6	Low alloy steel	Annealed	180	10	◎			
	7		Quenched & Tempered	275	29	◎			
	8		Quenched & Tempered	300	32	◎			
	9		Quenched & Tempered	350	38		◎		
	10		High alloyed steel, and tool steel	Annealed	200	15		○	
	11	Quenched & Tempered		325	35		◎		
M	12	Stainless steel	Ferritic / Martensitic Annealed	200	15				◎
	13		Martensitic Quenched & Tempered	240	23				◎
	14		Austenitic	180	10				◎
K	15	Grey cast iron	Pearlitic / ferritic	180	10		◎		
	16		Pearlitic (Martensitic)	260	26		◎		
	17	Nodular cast iron	Ferritic	160	3		◎		
	18		Pearlitic	250	25		◎		
	19		Ferritic	130			◎		
20	Malleable cast iron	Pearlitic	230	21		◎			
N	21	Aluminum-wrought alloy	Not Curable	60					
	22		Curable Hardened	100					
	23	Aluminum-cast, alloyed	≤ 12% Si, Not Curable	75					
	24		≤ 12% Si, Curable Hardened	90					
	25		> 12% Si, Not Curable	130					
	26	Copper and Copper Alloys (Bronze / Brass)	Cutting Alloys, PB>1%	110					
	27		CuZn, CuSnZn (Brass)	90					
	28		CuSn, lead-free copper and electrolytic copper	100					
	29	Non Metallic Materials	Duroplastic, Fiber Reinforced Plastic						
30	Rubber, Wood, etc.								
S	31	Heat Resistant Super Alloys	Fe Based Annealed	200	15				
	32		Cured	280	30				
	33		Annealed	250	25				
	34		Ni or Co Based Cured	350	38				
	35		Cast	320	34				
	36	Titanium Alloys	Pure Titanium	400 Rm					
	37		Alpha + Beta Alloys Hardened	1050 Rm					
H	38	Hardened steel	Hardened	550	55		○	◎	
	39		Hardened	630	60			◎	
	40	Hardened Cast Iron	Cast	400	42			○	
	41		Hardened	550	55			◎	

XMM110V	XMB110D	XMR110A	XMR120C	XMR260T	XMF110V	XMR110D	ZBC	ZBS	ZBT	ZRC	ZRS	ZRT
2	2	2	2	2	2	2	-	-	-	-	-	-
-	-	-	-	-	-	-	-	-	-	-	-	-
BALL NOSE	BALL NOSE	CORNER RADIUS	CORNER RADIUS	CORNER RADIUS	CORNER RADIUS	CORNER RADIUS	BALL NOSE	BALL NOSE	BALL NOSE	CORNER RADIUS	CORNER RADIUS	CORNER RADIUS
R4.0	R4.0	D8.0	D8.0	D8.0	D8.0	D8.0	-	-	-	-	-	-
R16.5	R16.5	D33.0	D33.0	D33.0	D33.0	D33.0	-	-	-	-	-	-
59	59	60	60	60	65	65	70	71	72	73	74	74
FULL RADIUS	-	-	-	-	HIGH FEED	-	STRAIGHT NECK	STRAIGHT NECK	TAPER NECK	STRAIGHT NECK	STRAIGHT NECK	TAPER NECK
Y-Coating	Diamond	AlTiN	X-Coating	Z-Coating	Y-Coating	Diamond	Carbide	Steel	Steel	Carbide	Steel	Steel
GENERAL PURPOSE	GRAPHITE	GENERAL PURPOSE STAINLESS STEELS	PRE-HARDENED STEELS	HIGH HARDENED STEELS	GENERAL PURPOSE	GRAPHITE						
												
⊙		⊙			⊙							1
⊙		⊙			⊙							2
⊙		⊙			⊙							3
⊙		⊙			⊙							4
		⊙			⊙							5
⊙		⊙			⊙							6 P
⊙		⊙			⊙							7
		⊙										8
⊙			⊙		⊙							9
			○			⊙						10
			○									11
		⊙										12
		⊙										13 M
		⊙										14
			⊙									15
			⊙									16
			⊙									17 K
			⊙									18
			⊙									19
			⊙									20
	○					○						21
	○					○						22
	○					○						23
	○					○						24
												25 N
												26
												27
												28
	⊙					⊙						29
												30
												31
												32
												33 S
												34
												35
												36
												37
			○									38
				⊙								39 H
				○								40
				○								41

HSS

CBN END MILLS

i-Xmill END MILLS

i-SMART MODULAR END MILLS

X5070 END MILLS

4G MILL END MILLS

X-POWER PRO END MILLS

TitaNox-POWER END MILLS

JET-POWER END MILLS

V7 PLUS END MILLS

ALU-POWER HPC END MILLS

ALU-POWER END MILLS

D-POWER GRAPHITE END MILLS

D-POWER CFRP END MILLS

ROUTERS

CRX S END MILLS

K-2 END MILLS

ONLY ONE COATED PM60 END MILLS

TANK-POWER END MILLS

GENERAL HSS END MILLS

MILLING CUTTERS

TECHNICAL DATA



i-Xmill BALL INSERTS

- i-Xmill WECHSELPLATTE mit RUNDER STIRN
- i-Xmill - Plaquette hémisphérique
- i-Xmill Placca emisferica

- ▶ Indexable Ball End Mill for economic use
- ▶ Three Types of Inserts are available
 - For General Purpose (~HRc50)
 - For Hardened Material (HRc40~HRc65)
 - For Graphite
- ▶ Special Geometry and Coating for Excellent Performance

- ▶ Kopierfräser mit Wechselplatte für wirtschaftlichen Einsatz.
- ▶ Drei Typen von Schneideinsätzen lieferbar
 - Für allgemeinen Einsatz (HRc50)
 - Für gehärtete Materialien (HRc40~HRc65)
 - Für Graphit
- ▶ Spezielle Geometrie und Beschichtung für höchste Leistu

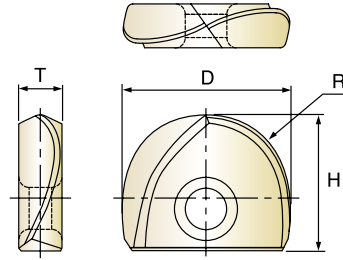

cutting conditions : p.76

Unit : mm

EDP No.			Radius of Ball Nose	Mill Diameter	Height	Thickness
AlTiN	X-Coating	Z-Coating				
For General Purpose	For Pre-Hardened Steels	For High Hardened Steels	R	D	H	T
XMB110A080	XMB120C080	XMB260T080	R4.0	8.0	8.0	2.4
XMB110A100	XMB120C100	XMB260T100	R5.0	10.0	9.5	2.7
XMB110A110	XMB120C110	XMB260T110	R5.5	11.0	10.0	2.7
XMB110A120	XMB120C120	XMB260T120	R6.0	12.0	11.0	3.2
XMB110A130	XMB120C130	XMB260T130	R6.5	13.0	11.5	3.2
XMB110A160	XMB120C160	XMB260T160	R8.0	16.0	13.0	4.2
XMB110A170	XMB120C170	XMB260T170	R8.5	17.0	13.5	4.2
XMB110A200	XMB120C200	XMB260T200	R10.0	20.0	16.0	5.2
XMB110A210	XMB120C210	XMB260T210	R10.5	21.0	16.5	5.2
XMB110A250	XMB120C250	XMB260T250	R12.5	25.0	19.5	6.2
XMB110A260	XMB120C260	XMB260T260	R13.0	26.0	20.0	6.2
XMB110A300	XMB120C300	XMB260T300	R15.0	30.0	23.5	7.2
XMB110A320	XMB120C320	XMB260T320	R16.0	32.0	24.5	7.2
XMB110A330	XMB120C330	XMB260T330	R16.5	33.0	25.0	7.2

▶ The ball radius tolerance is ±0.01mm and the set-up accuracy is ±0.02mm.

◎ : Excellent ○ : Good

ISO	P											M			K					
	Non-alloy steel					Low alloy steel					High alloyed steel, and tool steel		Stainless steel			Grey cast iron		Nodular cast iron		Malleable cast iron
Material Description	1	2	3	4	5	6	7	8	9	10	11	12	13	14	15	16	17	18	19	20
VDI 3323	1	2	3	4	5	6	7	8	9	10	11	12	13	14	15	16	17	18	19	20
HRc	13	25	28	32	38	42	48	52	58	62	68	72	78	82	88	92	98	102	108	112
HB	125	190	250	270	300	180	275	300	350	200	325	200	240	180	180	260	160	250	130	230
XMB110A	◎	◎	◎	◎	◎	◎	◎	◎		◎	○	◎				◎	◎	◎	◎	◎
XMB120C																				
XMB260T																				

ISO	N										S							H			
	Aluminum-wrought alloy		Aluminum-cast, alloyed			Copper and Copper Alloys (Bronze / Brass)			Non Metallic Materials		Heat Resistant Super Alloys					Titanium Alloys		Hardened steel	Chilled Cast Iron	Hardened Cast Iron	
Material Description	21	22	23	24	25	26	27	28	29	30	31	32	33	34	35	36	37	38	39	40	41
VDI 3323	21	22	23	24	25	26	27	28	29	30	31	32	33	34	35	36	37	38	39	40	41
HRc	21	22	23	24	25	26	27	28	29	30	31	32	33	34	35	36	37	38	39	40	41
HB	60	100	75	90	130	110	90	100			200	280	250	350	320	400 Rm	1050 Rm	550	630	400	550
XMB110A																					
XMB120C																					
XMB260T																		◎	◎	○	◎

i-Xmill BALL INSERTS

-  i-Xmill WECHSELPLATTE mit RUNDER STIRN
-  i-Xmill - Plaquette hémisphérique
-  i-Xmill Placca emisferica

- ▶ Indexable Ball End Mill for economic use
- ▶ Three Types of Inserts are available
 - For General Purpose (~HRc50)
 - For Hardened Material (HRc40~HRc65)
 - For Graphite
- ▶ Special Geometry and Coating for Excellent Performance

- ▶ Kopierfräser mit Wechselplatte für wirtschaftlichen Einsatz.
- ▶ Drei Typen von Schneideinsätzen lieferbar
 - Für allgemeinen Einsatz (HRc50)
 - Für gehärtete Materialien (HRc40~HRc65)
 - Für graphit
- ▶ Spezielle Geometrie und Beschichtung für höchste Leistu

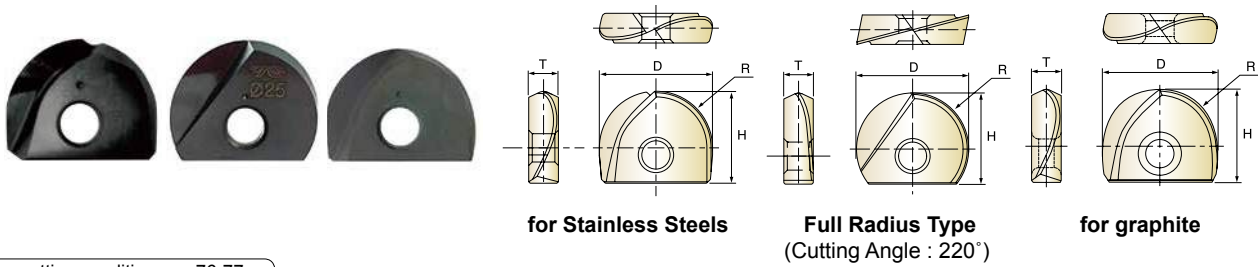

cutting conditions : p.76-77

Unit : mm

EDP No.			Radius of Ball Nose	Mill Diameter	Height	Thickness
AITiN	Y-Coating	Diamond				
For Stainless Steels	For General Purpose Full Radius Type	For Graphite	R	D	H	T
XMB130A080	XMM110V080	XMB110D080	R4.0	8.0	8.0	2.4
XMB130A100	XMM110V100	XMB110D100	R5.0	10.0	9.5	2.7
XMB130A110	XMM110V110	XMB110D110	R5.5	11.0	10.0	2.7
XMB130A120	XMM110V120	XMB110D120	R6.0	12.0	11.0	3.2
XMB130A130	XMM110V130	XMB110D130	R6.5	13.0	11.5	3.2
XMB130A160	XMM110V160	XMB110D160	R8.0	16.0	13.0	4.2
XMB130A170	XMM110V170	XMB110D170	R8.5	17.0	13.5	4.2
XMB130A200	XMM110V200	XMB110D200	R10.0	20.0	16.0	5.2
XMB130A210	XMM110V210	XMB110D210	R10.5	21.0	16.5	5.2
XMB130A250	XMM110V250	XMB110D250	R12.5	25.0	19.5	6.2
XMB130A260	XMM110V260	XMB110D260	R13.0	26.0	20.0	6.2
XMB130A300	XMM110V300	XMB110D300	R15.0	30.0	23.5	7.2
XMB130A320	XMM110V320	XMB110D320	R16.0	32.0	24.5	7.2
XMB130A330	XMM110V330	XMB110D330	R16.5	33.0	25.0	7.2

▶ The ball radius tolerance is ±0.01mm and the set-up accuracy is ±0.02mm.

◎ : Excellent ○ : Good

ISO	P										M			K												
	Non-alloy steel					Low alloy steel					High alloyed steel, and tool steel			Stainless steel			Grey cast iron		Nodular cast iron		Malleable cast iron					
Material Description	1	2	3	4	5	6	7	8	9	10	11	12	13	14	15	16	17	18	19	20	21	22				
VDI 3323	1	2	3	4	5	6	7	8	9	10	11	12	13	14	15	16	17	18	19	20	21	22				
HRC	13	25	28	32	30	10	29	32	38	15	35	15	23	10	10	26	3	25	3	25	4	21				
HB	125	190	250	270	300	180	275	300	350	200	325	200	240	180	180	260	160	250	130	230						
XMB130A												◎	◎	◎												
XMM110V	◎	◎	◎	◎		◎	◎			◎																
XMB110D																										
ISO	N									S						H										
Material Description	Aluminum-wrought alloy			Aluminum-cast, alloyed			Copper and Copper Alloys (Bronze / Brass)			Non Metallic Materials			Heat Resistant Super Alloys						Titanium Alloys		Hardened steel		Chilled Cast Iron		Hardened Cast Iron	
VDI 3323	21	22	23	24	25	26	27	28	29	30	31	32	33	34	35	36	37	38	39	40	41	42	43	44	45	
HRC	21	22	23	24	25	26	27	28	29	30	31	32	33	34	35	36	37	38	39	40	41	42	43	44	45	
HB	60	100	75	90	130	110	90	100			15	30	25	38	34	200	280	250	350	320	400 Rm	1050 Rm	550	630	400	550
XMB130A																										
XMM110V																										
XMB110D	○	○	○	○						◎																

i-Xmill CORNER RADIUS INSERT

- i-Xmill WECHSELPLATTE mit GERADER STIRN UND ECKRADIUS
- i-Xmill - Plaquette pour usage général et inox
- INSERTI IN MD, TORICI

- ▶ The optimum geometry of the tool to achieve better reliability and less vibration and cutting load.
- ▶ Interchangeability with i-Xmill ball holder, but the precise cutting is possible with i-Xmill corner radius holder due to higher stability and strength of tool.
- ▶ The various and wide cutting range makes it possible to machine over the roughing and finishing.
- ▶ Special coating makes high hardness with high thermal stability against oxidation.

- ▶ Die optimale Werkzeuggeometrie für große Betriebssicherheit und geringe Vibration und Schneidendruck.
- ▶ Einsetzbar wie i-Xmill Rundplattenhalter, aber eine größere Schnittgenauigkeit ist mit dem Vierkantplattenhalter möglich, wegen der größeren Steifigkeit und Stärke des Werkzeugs.
- ▶ Die große Einsatzbreite des Werkzeugs macht den Einsatz sowohl zum Schruppen als auch zum Schlichten möglich.
- ▶ Eine spezielle Beschichtung verleiht der Schneide große Härte und Hitzebeständigkeit.

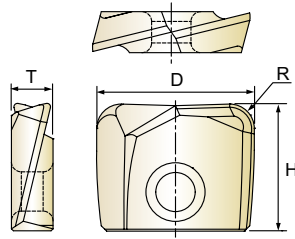

cutting conditions : p.78

Unit : mm

EDP No.			Corner Radius	Mill Diameter	Height	Thickness
AlTiN	X-Coating	Z-Coating				
For General Purpose & Stainless Steels	For Pre-Hardened Steels	For High Hardened Steels	R	D	H	T
XMR110A080 03	XMR120C080 03	XMR260T080 03	R0.3	8.0	8.0	2.4
XMR110A080 05	XMR120C080 05	XMR260T080 05	R0.5	8.0	8.0	2.4
XMR110A080 10	XMR120C080 10	XMR260T080 10	R1.0	8.0	8.0	2.4
XMR110A080 20	XMR120C080 20	XMR260T080 20	R2.0	8.0	8.0	2.4
XMR110A100 03	XMR120C100 03	XMR260T100 03	R0.3	10.0	9.5	2.7
XMR110A100 05	XMR120C100 05	XMR260T100 05	R0.5	10.0	9.5	2.7
XMR110A100 10	XMR120C100 10	XMR260T100 10	R1.0	10.0	9.5	2.7
XMR110A100 15	XMR120C100 15	XMR260T100 15	R1.5	10.0	9.5	2.7
XMR110A100 20	XMR120C100 20	XMR260T100 20	R2.0	10.0	9.5	2.7
XMR110A100 30	XMR120C100 30	XMR260T100 30	R3.0	10.0	9.5	2.7
XMR110A110 03	XMR120C110 03	XMR260T110 03	R0.3	11.0	9.5	2.7
XMR110A110 05	XMR120C110 05	XMR260T110 05	R0.5	11.0	9.5	2.7
XMR110A110 10	XMR120C110 10	XMR260T110 10	R1.0	11.0	9.5	2.7
XMR110A110 15	XMR120C110 15	XMR260T110 15	R1.5	11.0	9.5	2.7
XMR110A110 20	XMR120C110 20	XMR260T110 20	R2.0	11.0	9.5	2.7
XMR110A110 30	XMR120C110 30	XMR260T110 30	R3.0	11.0	9.5	2.7

▶ The corner radius tolerance is ±0.015mm and the set-up accuracy is ±0.02mm.

▶ NEXT PAGE

◎ : Excellent ○ : Good

ISO	P											M			K					
	Non-alloy steel					Low alloy steel					High alloyed steel, and tool steel		Stainless steel			Grey cast iron		Nodular cast iron		Malleable cast iron
Material Description	1	2	3	4	5	6	7	8	9	10	11	12	13	14	15	16	17	18	19	20
VDI 3323	1	2	3	4	5	6	7	8	9	10	11	12	13	14	15	16	17	18	19	20
Hrc	13	25	28	32	32	10	29	32	38	15	35	15	23	10	10	26	3	25	3	21
HB	125	190	250	270	300	180	275	300	350	200	325	200	240	180	180	260	160	250	130	230
XMR110A	◎	◎	◎	◎	◎	◎	◎	◎		◎	◎	◎	◎	◎						
XMR120C									◎	○	◎				◎	◎	◎	◎	◎	◎
XMR260T																				

ISO	N										S							H			
	Aluminum-wrought alloy		Aluminum-cast, alloyed			Copper and Copper Alloys (Bronze / Brass)			Non Metallic Materials		Heat Resistant Super Alloys					Titanium Alloys		Hardened steel	Chilled Cast Iron	Hardened Cast Iron	
Material Description	21	22	23	24	25	26	27	28	29	30	31	32	33	34	35	36	37	38	39	40	41
VDI 3323	21	22	23	24	25	26	27	28	29	30	31	32	33	34	35	36	37	38	39	40	41
Hrc	21	22	23	24	25	26	27	28	29	30	31	32	33	34	35	36	37	38	39	40	41
HB	60	100	75	90	130	110	90	100			200	280	250	350	320	400 Rm	1050 Rm	550	630	400	550
XMR110A																					
XMR120C																		○			
XMR260T																		◎	◎	○	◎

i-Xmill CORNER RADIUS INSERT

- i-Xmill WECHSELPLATTE mit GERADER STIRN UND ECKRADIUS
- i-Xmill - Plaquette pour usage général et inox
- INSERTI IN MD, TORIC

- ▶ The optimum geometry of the tool to achieve better reliability and less vibration and cutting load.
- ▶ Interchangeability with i-Xmill ball holder, but the precise cutting is possible with i-Xmill corner radius holder due to higher stability and strength of tool.
- ▶ The various and wide cutting range makes it possible to machine over the roughing and finishing.
- ▶ Special coating makes high hardness with high thermal stability against oxidation.

- ▶ Die optimale Werkzeuggeometrie für große Betriebssicherheit und geringe Vibration und Schneidendruck.
- ▶ Einsetzbar wie i-Xmill Rundplattenhalter, aber eine größere Schnittgenauigkeit ist mit dem Vierkantplattenhalter möglich, wegen der größeren Steifigkeit und Stärke des Werkzeugs.
- ▶ Die große Einsatzbreite des Werkzeugs macht den Einsatz sowohl zum Schruppen als auch zum Schlichten möglich.
- ▶ Eine spezielle Beschichtung verleiht der Schneide große Härte und Hitzebeständigkeit.

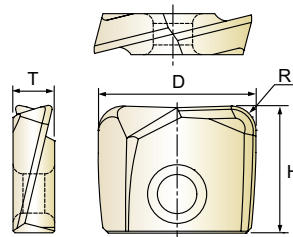

cutting conditions : p.78

Unit : mm

EDP No.			Corner Radius	Mill Diameter	Height	Thickness
AITiN	X-Coating	Z-Coating				
For General Purpose & Stainless Steels	For Pre-Hardened Steels	For High Hardened Steels	R	D	H	T
XMR110A120 03	XMR120C120 03	XMR260T120 03	R0.3	12.0	11.0	3.2
XMR110A120 05	XMR120C120 05	XMR260T120 05	R0.5	12.0	11.0	3.2
XMR110A120 10	XMR120C120 10	XMR260T120 10	R1.0	12.0	11.0	3.2
XMR110A120 15	XMR120C120 15	XMR260T120 15	R1.5	12.0	11.0	3.2
XMR110A120 20	XMR120C120 20	XMR260T120 20	R2.0	12.0	11.0	3.2
XMR110A120 30	XMR120C120 30	XMR260T120 30	R3.0	12.0	11.0	3.2
XMR110A130 03	XMR120C130 03	XMR260T130 03	R0.3	13.0	11.2	3.2
XMR110A130 05	XMR120C130 05	XMR260T130 05	R0.5	13.0	11.2	3.2
XMR110A130 10	XMR120C130 10	XMR260T130 10	R1.0	13.0	11.2	3.2
XMR110A130 15	XMR120C130 15	XMR260T130 15	R1.5	13.0	11.2	3.2
XMR110A130 20	XMR120C130 20	XMR260T130 20	R2.0	13.0	11.2	3.2
XMR110A130 30	XMR120C130 30	XMR260T130 30	R3.0	13.0	11.2	3.2
XMR110A160 03	XMR120C160 03	XMR260T160 03	R0.3	16.0	13.0	4.2
XMR110A160 05	XMR120C160 05	XMR260T160 05	R0.5	16.0	13.0	4.2
XMR110A160 10	XMR120C160 10	XMR260T160 10	R1.0	16.0	13.0	4.2
XMR110A160 15	XMR120C160 15	XMR260T160 15	R1.5	16.0	13.0	4.2
XMR110A160 20	XMR120C160 20	XMR260T160 20	R2.0	16.0	13.0	4.2
XMR110A160 30	XMR120C160 30	XMR260T160 30	R3.0	16.0	13.0	4.2

▶ The corner radius tolerance is ±0.015mm and the set-up accuracy is ±0.02mm.

▶ NEXT PAGE

◎ : Excellent ○ : Good

ISO Material Description	P									M			K							
	Non-alloy steel					Low alloy steel				High alloyed steel, and tool steel	Stainless steel			Grey cast iron		Nodular cast iron		Malleable cast iron		
VDI 3323	1	2	3	4	5	6	7	8	9	10	11	12	13	14	15	16	17	18	19	20
HRC	13	25	28	32	38	10	29	32	38	15	35	15	23	10	10	26	3	25	3	21
HB	125	190	250	270	300	180	275	300	350	200	325	200	240	180	180	260	160	250	130	230
XMR110A	◎	◎	◎	◎	◎	◎	◎	◎	◎	○	○	◎	◎	◎	◎	◎	◎	◎	◎	◎
XMR120C									◎	◎	◎				◎	◎	◎	◎	◎	◎
XMR260T																				

ISO Material Description	N					S					H										
	Aluminum-wrought alloy		Aluminum-cast, alloyed			Copper and Copper Alloys (Bronze / Brass)			Non Metallic Materials		Heat Resistant Super Alloys			Titanium Alloys		Hardened steel	Chilled Cast Iron	Hardened Cast Iron			
VDI 3323	21	22	23	24	25	26	27	28	29	30	31	32	33	34	35	36	37	38	39	40	41
HRC	21	22	23	24	25	26	27	28	29	30	31	32	33	34	35	36	37	55	60	42	55
HB	60	100	75	90	130	110	90	100			200	280	250	350	320	400 Rm	1050 Rm	550	630	400	550
XMR110A																		○			
XMR120C																		◎	◎	○	◎
XMR260T																					



i-Xmill CORNER RADIUS INSERT

- i-Xmill WECHSELPLATTE mit GERADER STIRN UND ECKRADIUS
- i-Xmill - Plaquette pour usage général et inox
- INSERTI IN MD, TORICI

- ▶ The optimum geometry of the tool to achieve better reliability and less vibration and cutting load.
- ▶ Interchangeability with i-Xmill ball holder, but the precise cutting is possible with i-Xmill corner radius holder due to higher stability and strength of tool.
- ▶ The various and wide cutting range makes it possible to machine over the roughing and finishing.
- ▶ Special coating makes high hardness with high thermal stability against oxidation.

- ▶ Die optimale Werkzeuggeometrie für große Betriebssicherheit und geringe Vibration und Schneidendruck.
- ▶ Einsetzbar wie i-Xmill Rundplattenhalter, aber eine größere Schnittgenauigkeit ist mit dem Vierkantplattenhalter möglich, wegen der größeren Steifigkeit und Stärke des Werkzeugs.
- ▶ Die große Einsatzbreite des Werkzeugs macht den Einsatz sowohl zum Schruppen als auch zum Schlichten möglich.
- ▶ Eine spezielle Beschichtung verleiht der Schneide große Härte und Hitzebeständigkeit.

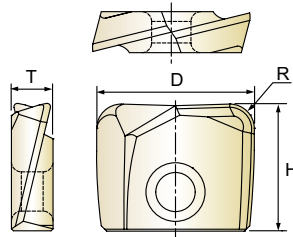

cutting conditions : p.78

Unit : mm

EDP No.			Corner Radius	Mill Diameter	Height	Thickness
AlTiN	X-Coating	Z-Coating				
For General Purpose & Stainless Steels	For Pre-Hardened Steels	For High Hardened Steels	R	D	H	T
XMR110A170 03	XMR120C170 03	XMR260T170 03	R0.3	17.0	13.0	4.2
XMR110A170 05	XMR120C170 05	XMR260T170 05	R0.5	17.0	13.0	4.2
XMR110A170 10	XMR120C170 10	XMR260T170 10	R1.0	17.0	13.0	4.2
XMR110A170 15	XMR120C170 15	XMR260T170 15	R1.5	17.0	13.0	4.2
XMR110A170 20	XMR120C170 20	XMR260T170 20	R2.0	17.0	13.0	4.2
XMR110A170 30	XMR120C170 30	XMR260T170 30	R3.0	17.0	13.0	4.2
XMR110A200 03	XMR120C200 03	XMR260T200 03	R0.3	20.0	16.0	5.2
XMR110A200 05	XMR120C200 05	XMR260T200 05	R0.5	20.0	16.0	5.2
XMR110A200 10	XMR120C200 10	XMR260T200 10	R1.0	20.0	16.0	5.2
XMR110A200 15	XMR120C200 15	XMR260T200 15	R1.5	20.0	16.0	5.2
XMR110A200 20	XMR120C200 20	XMR260T200 20	R2.0	20.0	16.0	5.2
XMR110A200 30	XMR120C200 30	XMR260T200 30	R3.0	20.0	16.0	5.2
XMR110A210 03	XMR120C210 03	XMR260T210 03	R0.3	21.0	16.0	5.2
XMR110A210 05	XMR120C210 05	XMR260T210 05	R0.5	21.0	16.0	5.2
XMR110A210 10	XMR120C210 10	XMR260T210 10	R1.0	21.0	16.0	5.2
XMR110A210 15	XMR120C210 15	XMR260T210 15	R1.5	21.0	16.0	5.2
XMR110A210 20	XMR120C210 20	XMR260T210 20	R2.0	21.0	16.0	5.2
XMR110A210 30	XMR120C210 30	XMR260T210 30	R3.0	21.0	16.0	5.2

▶ The corner radius tolerance is ±0.015mm and the set-up accuracy is ±0.02mm.

▶ NEXT PAGE

◎ : Excellent ○ : Good

ISO	P											M			K					
	Non-alloy steel					Low alloy steel					High alloyed steel, and tool steel		Stainless steel			Grey cast iron		Nodular cast iron		Malleable cast iron
Material Description	1	2	3	4	5	6	7	8	9	10	11	12	13	14	15	16	17	18	19	20
VDI 3323	1	2	3	4	5	6	7	8	9	10	11	12	13	14	15	16	17	18	19	20
HRc	13	25	28	32	32	10	29	32	38	15	35	15	23	10	10	26	3	25	3	21
HB	125	190	250	270	300	180	275	300	350	200	325	200	240	180	180	260	160	250	130	230
XMR110A	◎	◎	◎	◎	◎	◎	◎	◎		◎	◎	◎	◎	◎						
XMR120C										◎	○				◎	◎	◎	◎	◎	◎
XMR260T																				

ISO	N										S							H			
	Aluminum-wrought alloy		Aluminum-cast, alloyed			Copper and Copper Alloys (Bronze / Brass)			Non Metallic Materials		Heat Resistant Super Alloys					Titanium Alloys		Hardened steel	Chilled Cast Iron	Hardened Cast Iron	
Material Description	21	22	23	24	25	26	27	28	29	30	31	32	33	34	35	36	37	38	39	40	41
VDI 3323	21	22	23	24	25	26	27	28	29	30	31	32	33	34	35	36	37	38	39	40	41
HRc	21	22	23	24	25	26	27	28	29	30	31	32	33	34	35	36	37	38	39	40	41
HB	60	100	75	90	130	110	90	100			200	280	250	350	320	400 Rm	1050 Rm	550	630	400	550
XMR110A																					
XMR120C																		◎	◎	○	◎
XMR260T																		◎	◎	○	◎

i-Xmill CORNER RADIUS INSERT

i-Xmill WECHSELPLATTE mit GERADER STIRN UND ECKRADIUS

i-Xmill - Plaquette pour usage général et inox
INSERTI IN MD, TORICI

- ▶ The optimum geometry of the tool to achieve better reliability and less vibration and cutting load.
- ▶ Interchangeability with i-Xmill ball holder, but the precise cutting is possible with i-Xmill corner radius holder due to higher stability and strength of tool.
- ▶ The various and wide cutting range makes it possible to machine over the roughing and finishing.
- ▶ Special coating makes high hardness with high thermal stability against oxidation.

- ▶ Die optimale Werkzeuggeometrie für große Betriebssicherheit und geringe Vibration und Schneidendruck.
- ▶ Einsetzbar wie i-Xmill Rundplattenhalter, aber eine größere Schnittgenauigkeit ist mit dem Vierkantplattenhalter möglich, wegen der größeren Steifigkeit und Stärke des Werkzeugs.
- ▶ Die große Einsatzbreite des Werkzeugs macht den Einsatz sowohl zum Schruppen als auch zum Schlichten möglich.
- ▶ Eine spezielle Beschichtung verleiht der Schneide große Härte und Hitzebeständigkeit.

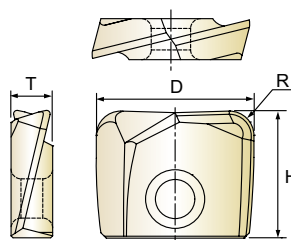

cutting conditions : p.78

Unit : mm

EDP No.			Corner Radius	Mill Diameter	Height	Thickness
AITiN	X-Coating	Z-Coating				
For General Purpose & Stainless Steels	For Pre-Hardened Steels	For High Hardened Steels	R	D	H	T
XMR110A250 03	XMR120C250 03	XMR260T250 03	R0.3	25.0	19.5	6.2
XMR110A250 05	XMR120C250 05	XMR260T250 05	R0.5	25.0	19.5	6.2
XMR110A250 10	XMR120C250 10	XMR260T250 10	R1.0	25.0	19.5	6.2
XMR110A250 15	XMR120C250 15	XMR260T250 15	R1.5	25.0	19.5	6.2
XMR110A250 20	XMR120C250 20	XMR260T250 20	R2.0	25.0	19.5	6.2
XMR110A250 30	XMR120C250 30	XMR260T250 30	R3.0	25.0	19.5	6.2
XMR110A260 03	XMR120C260 03	XMR260T260 03	R0.3	26.0	19.5	6.2
XMR110A260 05	XMR120C260 05	XMR260T260 05	R0.5	26.0	19.5	6.2
XMR110A260 10	XMR120C260 10	XMR260T260 10	R1.0	26.0	19.5	6.2
XMR110A260 15	XMR120C260 15	XMR260T260 15	R1.5	26.0	19.5	6.2
XMR110A260 20	XMR120C260 20	XMR260T260 20	R2.0	26.0	19.5	6.2
XMR110A260 30	XMR120C260 30	XMR260T260 30	R3.0	26.0	19.5	6.2
XMR110A300 03	XMR120C300 03	XMR260T300 03	R0.3	30.0	23.5	7.2
XMR110A300 05	XMR120C300 05	XMR260T300 05	R0.5	30.0	23.5	7.2
XMR110A300 10	XMR120C300 10	XMR260T300 10	R1.0	30.0	23.5	7.2
XMR110A300 15	XMR120C300 15	XMR260T300 15	R1.5	30.0	23.5	7.2
XMR110A300 20	XMR120C300 20	XMR260T300 20	R2.0	30.0	23.5	7.2
XMR110A300 30	XMR120C300 30	XMR260T300 30	R3.0	30.0	23.5	7.2

▶ The corner radius tolerance is ± 0.015 mm and the set-up accuracy is ± 0.02 mm.

▶ NEXT PAGE

◎ : Excellent ○ : Good

ISO Material Description	P									M			K							
	Non-alloy steel					Low alloy steel				High alloyed steel, and tool steel	Stainless steel			Grey cast iron		Nodular cast iron		Malleable cast iron		
VDI 3323	1	2	3	4	5	6	7	8	9	10	11	12	13	14	15	16	17	18	19	20
HRC	13	25	28	32	38	10	29	32	38	15	35	15	23	10	10	26	3	25	25	21
HB	125	190	250	270	300	180	275	300	350	200	325	200	240	180	180	260	160	250	130	230
XMR110A	◎	◎	◎	◎	◎	◎	◎	◎		○		◎	◎	◎						
XMR120C									◎	◎	◎				◎	◎	◎	◎	◎	◎
XMR260T																				

ISO Material Description	N					S					H										
	Aluminum-wrought alloy		Aluminum-cast, alloyed			Copper and Copper Alloys (Bronze / Brass)			Non Metallic Materials		Heat Resistant Super Alloys			Titanium Alloys		Hardened steel	Chilled Cast Iron	Hardened Cast Iron			
VDI 3323	21	22	23	24	25	26	27	28	29	30	31	32	33	34	35	36	37	38	39	40	41
HRC											15	30	25	38	34			55	60	42	55
HB	60	100	75	90	130	110	90	100			200	280	250	350	320	400 Rm	1050 Rm	550	630	400	550
XMR110A																					
XMR120C																		○			
XMR260T																		◎	◎	○	◎



XMR110A SERIES
XMR120C SERIES
XMR260T SERIES

i-Xmill CORNER RADIUS INSERT

- **i-Xmill WECHSELPLATTE mit GERADER STIRN UND ECKRADIUS**
- **i-Xmill - Plaquette pour usage général et inox**
- **INSERTI IN MD, TORICI**

- ▶ The optimum geometry of the tool to achieve better reliability and less vibration and cutting load.
- ▶ Interchangeability with i-Xmill ball holder, but the precise cutting is possible with i-Xmill corner radius holder due to higher stability and strength of tool.
- ▶ The various and wide cutting range makes it possible to machine over the roughing and finishing.
- ▶ Special coating makes high hardness with high thermal stability against oxidation.

- ▶ Die optimale Werkzeuggeometrie für große Betriebssicherheit und geringe Vibration und Schneidendruck.
- ▶ Einsetzbar wie i-Xmill Rundplattenhalter, aber eine größere Schnittgenauigkeit ist mit dem Vierkantplattenhalter möglich, wegen der größeren Steifigkeit und Stärke des Werkzeugs.
- ▶ Die große Einsatzbreite des Werkzeugs macht den Einsatz sowohl zum Schruppen als auch zum Schlichten möglich.
- ▶ Eine spezielle Beschichtung verleiht der Schneide große Härte und Hitzebeständigkeit.

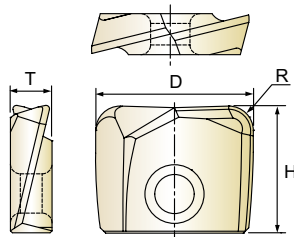

cutting conditions : p.78

Unit : mm

EDP No.			Corner Radius	Mill Diameter	Height	Thickness
AlTiN	X-Coating	Z-Coating				
For General Purpose & Stainless Steels	For Pre-Hardened Steels	For High Hardened Steels	R	D	H	T
XMR110A320 03	XMR120C320 03	XMR260T320 03	R0.3	32.0	23.5	7.2
XMR110A320 05	XMR120C320 05	XMR260T320 05	R0.5	32.0	23.5	7.2
XMR110A320 10	XMR120C320 10	XMR260T320 10	R1.0	32.0	23.5	7.2
XMR110A320 15	XMR120C320 15	XMR260T320 15	R1.5	32.0	23.5	7.2
XMR110A320 20	XMR120C320 20	XMR260T320 20	R2.0	32.0	23.5	7.2
XMR110A320 30	XMR120C320 30	XMR260T320 30	R3.0	32.0	23.5	7.2
XMR110A330 03	XMR120C330 03	XMR260T330 03	R0.3	33.0	23.5	7.2
XMR110A330 05	XMR120C330 05	XMR260T330 05	R0.5	33.0	23.5	7.2
XMR110A330 10	XMR120C330 10	XMR260T330 10	R1.0	33.0	23.5	7.2
XMR110A330 15	XMR120C330 15	XMR260T330 15	R1.5	33.0	23.5	7.2
XMR110A330 20	XMR120C330 20	XMR260T330 20	R2.0	33.0	23.5	7.2

▶ The corner radius tolerance is ±0.015mm and the set-up accuracy is ±0.02mm.

◎ : Excellent ○ : Good

ISO	P											M			K							
	Non-alloy steel					Low alloy steel						High alloyed steel, and tool steel			Stainless steel			Grey cast iron		Nodular cast iron		Malleable cast iron
Material Description	1	2	3	4	5	6	7	8	9	10	11	12	13	14	15	16	17	18	19	20		
VDI 3323	1	2	3	4	5	6	7	8	9	10	11	12	13	14	15	16	17	18	19	20		
HRc	13	25	28	32	38	42	48	52	58	62	68	72	78	82	88	92	98	102	108	112		
HB	125	190	250	270	300	180	275	300	350	200	325	200	240	180	180	260	160	250	130	230		
XMR110A	◎	◎	◎	◎	◎	◎	◎	◎	◎	◎	◎	◎	◎	◎	◎	◎	◎	◎	◎	◎		
XMR120C										◎	◎				◎	◎	◎	◎	◎	◎		
XMR260T																						

ISO	N										S							H			
	Aluminum-wrought alloy		Aluminum-cast, alloyed			Copper and Copper Alloys (Bronze / Brass)			Non Metallic Materials		Heat Resistant Super Alloys					Titanium Alloys		Hardened steel	Chilled Cast Iron	Hardened Cast Iron	
Material Description	21	22	23	24	25	26	27	28	29	30	31	32	33	34	35	36	37	38	39	40	41
VDI 3323	21	22	23	24	25	26	27	28	29	30	31	32	33	34	35	36	37	38	39	40	41
HRc	21	22	23	24	25	26	27	28	29	30	31	32	33	34	35	36	37	38	39	40	41
HB	60	100	75	90	130	110	90	100			200	280	250	350	320	400 Rm	1050 Rm	550	630	400	550
XMR110A																					
XMR120C																		◎	◎	◎	◎
XMR260T																					

i-Xmill CORNER RADIUS INSERT

- i-Xmill WECHSELPLATTE mit GERADER STIRN UND ECKRADIUS
- i-Xmill Plaquette Torique AVEC RAYON de coupe frontale
- INSERTI IN MD, TORICI & TORICI HIGH FEED

- ▶ The optimum geometry of the tool to achieve better reliability and less vibration and cutting load.
- ▶ Interchangeability with i-Xmill ball holder, but the precise cutting is possible with i-Xmill corner radius holder due to higher stability and strength of tool.
- ▶ The various and wide cutting range makes it possible to machine over the roughing and finishing.
- ▶ Special coating makes high hardness with high thermal stability against oxidation.

- ▶ Die optimale Werkzeuggeometrie für große Betriebssicherheit und geringe Vibration und Schneidendruck.
- ▶ Einsetzbar wie i-Xmill Rundplattenhalter, aber eine größere Schnittgenauigkeit ist mit dem Vierkantplattenhalter möglich, wegen der größeren Steifigkeit und Stärke des Werkzeugs.
- ▶ Die große Einsatzbreite des Werkzeugs macht den Einsatz sowohl zum Schruppen als auch zum Schlichten möglich.
- ▶ Eine spezielle Beschichtung verleiht der Schneide große Härte und Hitzebeständigkeit.

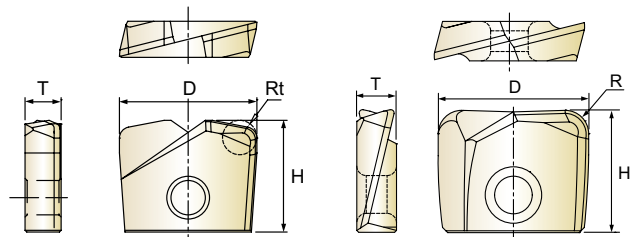
High Feed

cutting conditions : p.79

Unit : mm

EDP No.		Corner Radius	Mill Diameter	Height	Thickness	for High Feed
Y-Coating	Diamond					
For General Purpose High Feed	For Graphite	R (Rt)	D	H	T	apMax.
-	XMR110D080 03	R0.3	8.0	8.0	2.4	0.4
-	XMR110D080 05	R0.5	8.0	8.0	2.4	0.4
XMF110V080 08	-	R0.8	8.0	8.0	2.4	0.4
-	XMR110D080 10	R1.0	8.0	8.0	2.4	0.4
-	XMR110D080 20	R2.0	8.0	8.0	2.4	0.4
-	XMR110D100 03	R0.3	10.0	9.5	2.7	0.5
-	XMR110D100 05	R0.5	10.0	9.5	2.7	0.5
XMF110V100 10	XMR110D100 10	R1.0	10.0	9.5	2.7	0.5
-	XMR110D100 15	R1.5	10.0	9.5	2.7	0.5
-	XMR110D100 20	R2.0	10.0	9.5	2.7	0.5
-	XMR110D100 30	R3.0	10.0	9.5	2.7	0.5
-	XMR110D110 03	R0.3	11.0	9.5	2.7	0.5
-	XMR110D110 05	R0.5	11.0	9.5	2.7	0.5
XMF110V110 10	XMR110D110 10	R1.0	11.0	9.5	2.7	0.5
-	XMR110D110 15	R1.5	11.0	9.5	2.7	0.5
-	XMR110D110 20	R2.0	11.0	9.5	2.7	0.5
-	XMR110D110 30	R3.0	11.0	9.5	2.7	0.5

▶ The corner radius tolerance is ±0.015mm and the set-up accuracy is ±0.02mm.

▶ NEXT PAGE

◎ : Excellent ○ : Good

ISO Material Description	P										M				K						
	Non-alloy steel					Low alloy steel					High alloyed steel, and tool steel		Stainless steel		Grey cast iron		Nodular cast iron		Malleable cast iron		
VDI 3323	1	2	3	4	5	6	7	8	9	10	11	12	13	14	15	16	17	18	19	20	
HRc	13	25	28	32	38	10	29	32	38	15	35	15	23	10	10	26	3	25	21		
HB	125	190	250	270	300	180	275	300	350	200	325	200	240	180	180	260	160	250	130	230	
XMF110V	◎	◎	◎	◎	◎	◎	◎			◎											
XMR110D																					
ISO Material Description	N									S							H				
	Aluminum- wrought alloy		Aluminum-cast, alloyed			Copper and Copper Alloys (Bronze / Brass)				Non Metallic Materials		Heat Resistant Super Alloys					Titanium Alloys		Hardened steel	Chilled Cast Iron	Hardened Cast Iron
VDI 3323	21	22	23	24	25	26	27	28	29	30	31	32	33	34	35	36	37	38	39	40	41
HRc											15	30	25	38	34			55	60	42	55
HB	60	100	75	90	130	110	90	100			200	280	250	350	320	400 Rm	1050 Rm	550	630	400	550
XMF110V																					
XMR110D	○	○	○	○					◎												

i-Xmill CORNER RADIUS INSERT

- i-Xmill WECHSELPLATTE mit GERADER STIRN UND ECKRADIUS
- i-Xmill Plaquelette Torique AVEC RAYON de coupe frontale
- INSERTI IN MD, TORICI & TORICI HIGH FEED

- ▶ The optimum geometry of the tool to achieve better reliability and less vibration and cutting load.
- ▶ Interchangeability with i-Xmill ball holder, but the precise cutting is possible with i-Xmill corner radius holder due to higher stability and strength of tool.
- ▶ The various and wide cutting range makes it possible to machine over the roughing and finishing.
- ▶ Special coating makes high hardness with high thermal stability against oxidation.

- ▶ Die optimale Werkzeuggeometrie für große Betriebssicherheit und geringe Vibration und Schneidendruck.
- ▶ Einsetzbar wie i-Xmill Rundplattenhalter, aber eine größere Schnittgenauigkeit ist mit dem Vierkantplattenhalter möglich, wegen der größeren Steifigkeit und Stärke des Werkzeugs.
- ▶ Die große Einsatzbreite des Werkzeugs macht den Einsatz sowohl zum Schruppen als auch zum Schlichten möglich.
- ▶ Eine spezielle Beschichtung verleiht der Schneide große Härte und Hitzebeständigkeit.

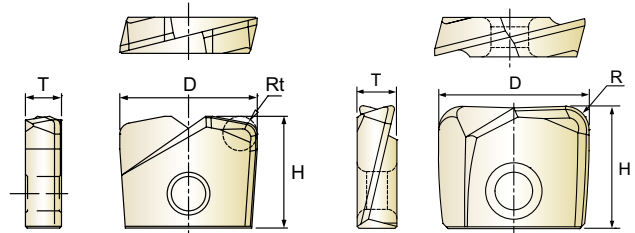

High Feed

cutting conditions : p.79

Unit : mm

EDP No.		Corner Radius	Mill Diameter	Height	Thickness	for High Feed
Y-Coating	Diamond					
For General Purpose High Feed	For Graphite	R (Rt)	D	H	T	apMax.
-	XMR110D120 03	R0.3	12.0	11.0	2.7	0.6
-	XMR110D120 05	R0.5	12.0	11.0	2.7	0.6
XMF110V120 10	XMR110D120 10	R1.0	12.0	11.0	2.7	0.6
-	XMR110D120 15	R1.5	12.0	11.0	2.7	0.6
-	XMR110D120 20	R2.0	12.0	11.0	2.7	0.6
-	XMR110D120 30	R3.0	12.0	11.0	2.7	0.6
-	XMR110D130 03	R0.3	13.0	11.2	2.7	0.6
-	XMR110D130 05	R0.5	13.0	11.2	2.7	0.6
XMF110V130 10	XMR110D130 10	R1.0	13.0	11.2	2.7	0.6
-	XMR110D130 15	R1.5	13.0	11.2	2.7	0.6
-	XMR110D130 20	R2.0	13.0	11.2	2.7	0.6
-	XMR110D130 30	R3.0	13.0	11.2	2.7	0.6
-	XMR110D160 03	R0.3	16.0	13.0	4.2	0.8
-	XMR110D160 05	R0.5	16.0	13.0	4.2	0.8
-	XMR110D160 10	R1.0	16.0	13.0	4.2	0.8
XMF110V160 15	XMR110D160 15	R1.5	16.0	13.0	4.2	0.8
-	XMR110D160 20	R2.0	16.0	13.0	4.2	0.8
-	XMR110D160 30	R3.0	16.0	13.0	4.2	0.8

▶ NEXT PAGE

◎ : Excellent ○ : Good

ISO Material Description	P										M			K							
	Non-alloy steel					Low alloy steel					High alloyed steel, and tool steel		Stainless steel			Grey cast iron		Nodular cast iron		Malleable cast iron	
VDI 3323	1	2	3	4	5	6	7	8	9	10	11	12	13	14	15	16	17	18	19	20	
HRc	13	25	28	32	30	10	29	32	38	15	35	15	23	10	10	26	3	25	21		
HB	125	190	250	270	300	180	275	300	350	200	325	200	240	180	180	260	160	250	130	230	
XMF110V	◎	◎	◎	◎	◎	◎	◎			◎											
XMR110D																					
ISO Material Description	N										S							H			
	Aluminum-wrought alloy		Aluminum-cast, alloyed			Copper and Copper Alloys (Bronze / Brass)			Non Metallic Materials		Heat Resistant Super Alloys					Titanium Alloys		Hardened steel	Chilled Cast Iron	Hardened Cast Iron	
VDI 3323	21	22	23	24	25	26	27	28	29	30	31	32	33	34	35	36	37	38	39	40	41
HRc											15	30	25	38	34			55	60	42	55
HB	60	100	75	90	130	110	90	100			200	280	250	350	320	400 Rm	1050 Rm	550	630	400	550
XMF110V																					
XMR110D	○	○	○	○					◎												

i-Xmill CORNER RADIUS INSERT

- i-Xmill WENDEPLATTE mit GERADER STIRN UND ECKRADIUS
- i-Xmill Plaquette Torique AVEC RAYON de coupe frontale
- INSERTI IN MD, TORICI & TORICI HIGH FEED

- ▶ The optimum geometry of the tool to achieve better reliability and less vibration and cutting load.
- ▶ Interchangeability with i-Xmill ball holder, but the precise cutting is possible with i-Xmill corner radius holder due to higher stability and strength of tool.
- ▶ The various and wide cutting range makes it possible to machine over the roughing and finishing.
- ▶ Special coating makes high hardness with high thermal stability against oxidation.

- ▶ Die optimale Werkzeuggeometrie für große Betriebssicherheit und geringe Vibration und Schneidendruck.
- ▶ Einsetzbar wie i-Xmill Rundplattenhalter, aber eine größere Schnittgenauigkeit ist mit dem Vierkantplattenhalter möglich, wegen der größeren Steifigkeit und Stärke des Werkzeugs.
- ▶ Die große Einsatzbreite des Werkzeugs macht den Einsatz sowohl zum Schruppen als auch zum Schlichten möglich.
- ▶ Eine spezielle Beschichtung verleiht der Schneide große Härte und Hitzebeständigkeit.

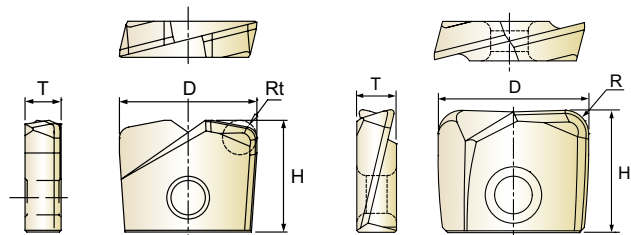
High Feed

cutting conditions : p.79

Unit : mm

EDP No.		Corner Radius	Mill Diameter	Height	Thickness	for High Feed
Y-Coating	Diamond					
For General Purpose High Feed	For Graphite	R (Rt)	D	H	T	apMax.
-	XMR110D170 03	R0.3	17.0	13.0	4.2	0.8
-	XMR110D170 05	R0.5	17.0	13.0	4.2	0.8
-	XMR110D170 10	R1.0	17.0	13.0	4.2	0.8
XMF110V170 15	XMR110D170 15	R1.5	17.0	13.0	4.2	0.8
-	XMR110D170 20	R2.0	17.0	13.0	4.2	0.8
-	XMR110D170 30	R3.0	17.0	13.0	4.2	0.8
-	XMR110D200 03	R0.3	20.0	16.0	5.2	1.0
-	XMR110D200 05	R0.5	20.0	16.0	5.2	1.0
-	XMR110D200 10	R1.0	20.0	16.0	5.2	1.0
-	XMR110D200 15	R1.5	20.0	16.0	5.2	1.0
XMF110V200 20	XMR110D200 20	R2.0	20.0	16.0	5.2	1.0
-	XMR110D200 30	R3.0	20.0	16.0	5.2	1.0
-	XMR110D210 03	R0.3	21.0	16.0	5.2	1.0
-	XMR110D210 05	R0.5	21.0	16.0	5.2	1.0
-	XMR110D210 10	R1.0	21.0	16.0	5.2	1.0
-	XMR110D210 15	R1.5	21.0	16.0	5.2	1.0
XMF110V210 20	XMR110D210 20	R2.0	21.0	16.0	5.2	1.0
-	XMR110D210 30	R3.0	21.0	16.0	5.2	1.0

▶ NEXT PAGE

◎ : Excellent ○ : Good

ISO Material Description	P										M						K					
	Non-alloy steel					Low alloy steel					High alloyed steel, and tool steel		Stainless steel				Grey cast iron		Nodular cast iron		Malleable cast iron	
VDI 3323	1	2	3	4	5	6	7	8	9	10	11	12	13	14	15	16	17	18	19	20		
HRc	13	23	25	28	32	10	29	32	38	15	35	15	23	10	10	26	3	25	21			
HB	125	190	250	270	300	180	275	300	350	200	325	200	240	180	180	260	160	250	130	230		
XMF110V	◎	◎	◎	◎	◎	◎	◎			◎												
XMR110D																						
ISO Material Description	N									S							H					
	Aluminum-wrought alloy			Aluminum-cast, alloyed			Copper and Copper Alloys (Bronze / Brass)			Non Metallic Materials	Heat Resistant Super Alloys					Titanium Alloys		Hardened steel	Chilled Cast Iron	Hardened Cast Iron		
VDI 3323	21	22	23	24	25	26	27	28	29	30	31	32	33	34	35	36	37	38	39	40	41	
HRc											15	30	25	38	34			55	60	42	55	
HB	60	100	75	90	130	110	90	100			200	280	250	350	320	400 Rm	1050 Rm	550	630	400	550	
XMF110V																						
XMR110D	○	○	○	○					◎													

i-Xmill CORNER RADIUS INSERT

- i-Xmill WENDEPLATTE mit GERADER STIRN UND ECKRADIUS
- i-Xmill Plaquette Torique AVEC RAYON de coupe frontale
- INSERTI IN MD, TORICI & TORICI HIGH FEED

- ▶ The optimum geometry of the tool to achieve better reliability and less vibration and cutting load.
- ▶ Interchangeability with i-Xmill ball holder, but the precise cutting is possible with i-Xmill corner radius holder due to higher stability and strength of tool.
- ▶ The various and wide cutting range makes it possible to machine over the roughing and finishing.
- ▶ Special coating makes high hardness with high thermal stability against oxidation.

- ▶ Die optimale Werkzeuggeometrie für große Betriebssicherheit und geringe Vibration und Schneidendruck.
- ▶ Einsetzbar wie i-Xmill Rundplattenhalter, aber eine größere Schnittgenauigkeit ist mit dem Vierkantplattenhalter möglich, wegen der größeren Steifigkeit und Stärke des Werkzeugs.
- ▶ Die große Einsatzbreite des Werkzeugs macht den Einsatz sowohl zum Schruppen als auch zum Schlichten möglich.
- ▶ Eine spezielle Beschichtung verleiht der Schneide große Härte und Hitzebeständigkeit.

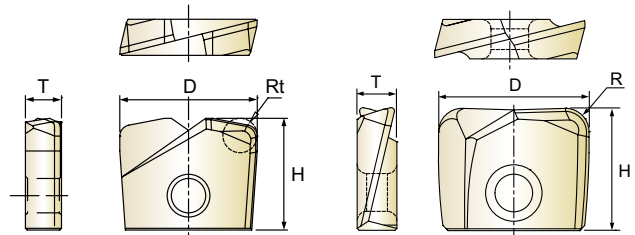

High Feed

cutting conditions : p.79

Unit : mm

EDP No.		Corner Radius	Mill Diameter	Height	Thickness	for High Feed
Y-Coating	Diamond					
For General Purpose High Feed	For Graphite	R (Rt)	D	H	T	apMax.
-	XMR110D250 03	R0.3	25.0	19.5	6.2	1.25
-	XMR110D250 05	R0.5	25.0	19.5	6.2	1.25
-	XMR110D250 10	R1.0	25.0	19.5	6.2	1.25
-	XMR110D250 15	R1.5	25.0	19.5	6.2	1.25
-	XMR110D250 20	R2.0	25.0	19.5	6.2	1.25
XMF110V250 25	-	R2.5	25.0	19.5	6.2	1.25
-	XMR110D250 30	R3.0	25.0	19.5	6.2	1.25
-	XMR110D260 03	R0.3	26.0	19.5	6.2	1.25
-	XMR110D260 05	R0.5	26.0	19.5	6.2	1.25
-	XMR110D260 10	R1.0	26.0	19.5	6.2	1.25
-	XMR110D260 15	R1.5	26.0	19.5	6.2	1.25
-	XMR110D260 20	R2.0	26.0	19.5	6.2	1.25
XMF110V260 25	-	R2.5	26.0	19.5	6.2	1.25
-	XMR110D260 30	R3.0	26.0	19.5	6.2	1.25
-	XMR110D300 03	R0.3	30.0	23.5	7.2	1.6
-	XMR110D300 05	R0.5	30.0	23.5	7.2	1.6
-	XMR110D300 10	R1.0	30.0	23.5	7.2	1.6
-	XMR110D300 15	R1.5	30.0	23.5	7.2	1.6
-	XMR110D300 20	R2.0	30.0	23.5	7.2	1.6
XMF110V300 30	XMR110D300 30	R3.0	30.0	23.5	7.2	1.6

▶ NEXT PAGE

◎ : Excellent ○ : Good

ISO Material Description	P										M			K							
	Non-alloy steel					Low alloy steel					High alloyed steel, and tool steel		Stainless steel			Grey cast iron		Nodular cast iron		Malleable cast iron	
VDI 3323	1	2	3	4	5	6	7	8	9	10	11	12	13	14	15	16	17	18	19	20	
HRc	13	25	28	32	30	10	29	32	38	15	35	15	23	10	10	26	3	25	21	21	
HB	125	190	250	270	300	180	275	300	350	200	325	200	240	180	180	260	160	250	130	230	
XMF110V	◎	◎	◎	◎	◎	◎	◎			◎											
XMR110D																					
ISO Material Description	N										S							H			
	Aluminum-wrought alloy		Aluminum-cast, alloyed			Copper and Copper Alloys (Bronze / Brass)			Non Metallic Materials		Heat Resistant Super Alloys					Titanium Alloys		Hardened steel	Chilled Cast Iron	Hardened Cast Iron	
VDI 3323	21	22	23	24	25	26	27	28	29	30	31	32	33	34	35	36	37	38	39	40	41
HRc											15	30	25	38	34			55	60	42	55
HB	60	100	75	90	130	110	90	100			200	280	250	350	320	400 Rm	1050 Rm	550	630	400	550
XMF110V																					
XMR110D	○	○	○	○					◎												

i-Xmill CORNER RADIUS INSERT

- i-Xmill WENDEPLATTE mit GERADER STIRN UND ECKRADIUS
- i-Xmill Plaquette Torique AVEC RAYON de coupe frontale
- INSERTI IN MD, TORICI & TORICI HIGH FEED

- ▶ The optimum geometry of the tool to achieve better reliability and less vibration and cutting load.
- ▶ Interchangeability with i-Xmill ball holder, but the precise cutting is possible with i-Xmill corner radius holder due to higher stability and strength of tool.
- ▶ The various and wide cutting range makes it possible to machine over the roughing and finishing.
- ▶ Special coating makes high hardness with high thermal stability against oxidation.

- ▶ Die optimale Werkzeuggeometrie für große Betriebssicherheit und geringe Vibration und Schneidendruck.
- ▶ Einsetzbar wie i-Xmill Rundplattenhalter, aber eine größere Schnittgenauigkeit ist mit dem Vierkantplattenhalter möglich, wegen der größeren Steifigkeit und Stärke des Werkzeugs.
- ▶ Die große Einsatzbreite des Werkzeugs macht den Einsatz sowohl zum Schruppen als auch zum Schlichten möglich.
- ▶ Eine spezielle Beschichtung verleiht der Schneide große Härte und Hitzebeständigkeit.

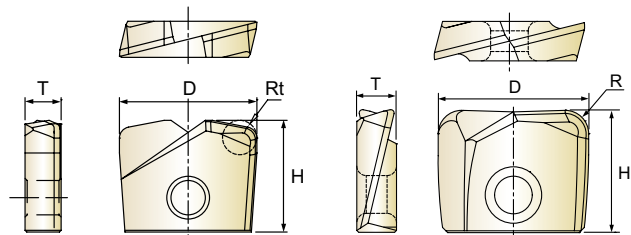
High Feed

cutting conditions : p.79

Unit : mm

EDP No.		Corner Radius	Mill Diameter	Height	Thickness	for High Feed
Y-Coating	Diamond					
For General Purpose High Feed	For Graphite	R (Rt)	D	H	T	apMax.
-	XMR110D320 03	R0.3	32.0	23.5	7.2	1.6
-	XMR110D320 05	R0.5	32.0	23.5	7.2	1.6
-	XMR110D320 10	R1.0	32.0	23.5	7.2	1.6
-	XMR110D320 15	R1.5	32.0	23.5	7.2	1.6
-	XMR110D320 20	R2.0	32.0	23.5	7.2	1.6
-	XMR110D320 30	R3.0	32.0	23.5	7.2	1.6
XMF110V320 32	XMR110D320 32	R3.2	32.0	23.5	7.2	1.6
-	XMR110D330 03	R0.3	33.0	23.5	7.2	1.6
-	XMR110D330 05	R0.5	33.0	23.5	7.2	1.6
-	XMR110D330 10	R1.0	33.0	23.5	7.2	1.6
-	XMR110D330 15	R1.5	33.0	23.5	7.2	1.6
-	XMR110D330 20	R2.0	33.0	23.5	7.2	1.6
-	XMR110D330 30	R3.0	33.0	23.5	7.2	1.6
XMF110V330 32	XMR110D330 32	R3.2	33.0	23.5	7.2	1.6

ISO Material Description	P										M						K					
	Non-alloy steel					Low alloy steel					High alloyed steel, and tool steel		Stainless steel				Grey cast iron		Nodular cast iron		Malleable cast iron	
VDI 3323	1	2	3	4	5	6	7	8	9	10	11	12	13	14	15	16	17	18	19	20		
HRc																						
HB	125	190	250	270	300	180	275	300	350	200	325	200	240	180	180	260	160	250	130	230		
XMF110V	◎	◎	◎	◎	◎	◎	◎			◎												
XMR110D																						
ISO Material Description	N										S						H					
	Aluminum- wrought alloy		Aluminum-cast, alloyed			Copper and Copper Alloys (Bronze / Brass)			Non Metallic Materials		Heat Resistant Super Alloys						Titanium Alloys		Hardened steel	Chilled Cast Iron	Hardened Cast Iron	
VDI 3323	21	22	23	24	25	26	27	28	29	30	31	32	33	34	35	36	37	38	39	40	41	
HRc																						
HB	60	100	75	90	130	110	90	100			200	280	250	350	320	400 Rm	1050 Rm	550	630	400	550	
XMF110V																						
XMR110D	○	○	○	○						◎												

◎ : Excellent ○ : Good

i-Xmill CARBIDE BALL HOLDER - STRAIGHT NECK

● i-Xmill HARTMETAL HALTER für WECHSEL PLATTE mit RUNDER STIRN - mit GERADER SCHAFT
 (●) Porte-plaquette i-Xmill en Carbure, entrée droite, pour plaquette à bout hémisphérique
 (●) CORPO FRESA IN MD PER INSERTI SEMISFERICI i-Xmill - CILINDRICO

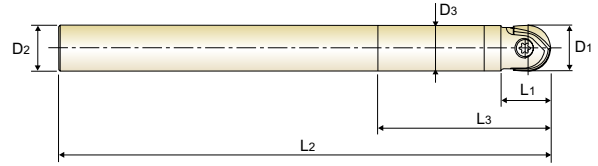

Unit : mm

EDP No.	Mill Diameter	Shank Diameter	Neck Diameter	Length of Cut	Length Below Shank	Overall Length	Length Type	Wrench No.	Screw No.
	D1	D2	D3	L1	L3	L2			
★ ZBC0801080	8	8	7.6	12	25	130	Regular	TWFT07	TX2508T07
★ ZBC0802080	8	8	7.6	12	40	130	Regular		
★ ZBC0803080	8	8	7.6	12	65	130	Regular		
ZBC0804080	8	8	7.6	12	60	150	Regular		
ZBC0805080	8	8	7.6	12	60	200	Long		
ZBC0806080	8	8	7.6	12	25	80	Short		
★ ZBC1001100	10, 11	10	9.5	15	30	140	Regular	TWFT08	TX3010T08
★ ZBC1002100	10, 11	10	9.5	15	50	140	Regular		
★ ZBC1003100	10, 11	10	9.5	15	75	140	Regular		
ZBC1004100	10, 11	10	9.5	15	60	180	Regular		
ZBC1005100	10, 11	10	9.5	15	60	200	Long		
ZBC1006100	10, 11	10	9.5	15	30	80	Short		
ZBC120001P	12, 13	12	11.4	17	40	200	Long	TWFT10	TX3512T10
★ ZBC1201120	12, 13	12	11.4	17	35	150	Regular		
★ ZBC1202120	12, 13	12	11.4	17	60	150	Regular		
★ ZBC1203120	12, 13	12	11.4	17	85	150	Regular		
ZBC1204120	12, 13	12	11.4	17	60	250	Long		
ZBC1205120	12, 13	12	11.4	17	35	100	Short		
ZBC160001P	16, 17	16	15.0	20	50	150	Regular	TWFT15	TX4016T15
★ ZBC1601160	16, 17	16	15.0	20	50	200	Long		
★ ZBC1602160	16, 17	16	15.0	20	80	200	Long		
★ ZBC1603160	16, 17	16	15.0	20	120	200	Long		
★ ZBC1604160	16, 17	16	15.0	20	80	250	Long		
ZBC1605160	16, 17	16	15.0	20	50	120	Short		
ZBC200002P	20, 21	20	19.0	25	60	150	Regular	● TWBT20	TX5020T20
★ ZBC2001200	20, 21	20	19.0	25	60	200	Regular		
★ ZBC2002200	20, 21	20	19.0	25	80	200	Regular		
★ ZBC2003200	20, 21	20	19.0	25	100	250	Long		
★ ZBC2004200	20, 21	20	19.0	25	150	250	Long		
ZBC2005200	20, 21	20	19.0	25	100	300	Long		
ZBC250001P	25, 26	25	24.0	30	75	150	Regular	● TWBT25	TX6025T25
★ ZBC2501250	25, 26	25	24.0	30	75	200	Regular		
★ ZBC2502250	25, 26	25	24.0	30	120	250	Regular		
★ ZBC2503250	25, 26	25	24.0	30	190	300	Long		
ZBC2504250	25, 26	25	24.0	30	120	350	Long		
ZBC2505250	25, 26	25	24.0	30	60	300	Long		
★ ZBC3001320	30, 32, 33	32	29.0	40	90	250	Regular	● TWBT30	TX8030T30
★ ZBC3002320	30, 32, 33	32	29.0	40	150	300	Long		
★ ZBC3003320	30, 32, 33	32	29.0	40	190	300	Long		
ZBC3004320	30, 32, 33	32	29.0	40	120	350	Long		
ZBC3005320	30, 32, 33	32	29.0	40	150	400	Long		

* Upon request, the broken holder is able to be regenerated

* ● Required to use T-HANDLE (TWH600)

* Your carbide holder can be regenerated as YG-1 type upon request

* ★ Stock Item

i-Xmill STEEL BALL HOLDER - STRAIGHT NECK

- i-Xmill STAHL HALTER für WECHSEL PLATTE mit RUNDER STIRN - mit GERADER SCHAFT
- ⌚ Porte-plaquette i-Xmill en acier, entrée droite, pour plaquette à bout hémisphérique
- 🇮🇹 CORPO FRESA IN ACCIAIO PER INSERTI SEMISFERICI i-Xmill - CILINDRICO

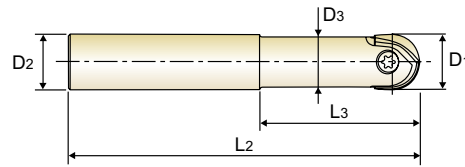

Unit : mm

EDP No.	Mill Diameter	Shank Diameter	Neck Diameter	Length Below Shank	Overall Length	Length Type	Wrench No.	Screw No.
	D ₁	D ₂	D ₃	L ₃	L ₂			
★ ZBS1201120	12, 13	12	10.5	35	90	Short		
★ ZBS1202120	12, 13	12	10.5	55	110	Regular	TWFT10	TX3512T10
ZBS120001P	12, 13	12	10.5	40	150	Long		
★ ZBS1601160	16, 17	16	14.5	35	95	Short		
★ ZBS1602160	16, 17	16	14.5	65	125	Regular	TWFT15	TX4016T15
ZBS160001P	16, 17	16	14.5	60	200	Long		
★ ZBS2001200	20, 21	20	18.0	40	110	Short		
★ ZBS2002200	20, 21	20	18.0	75	145	Regular	● TWBT20	TX5020T20
ZBS200001P	20, 21	20	18.0	80	200	Long		
ZBS200002P	20, 21	20	18.0	60	200	Long		
★ ZBS2501250	25, 26	25	22.5	45	125	Short		
★ ZBS2502250	25, 26	25	22.5	90	170	Regular	● TWBT25	TX6025T25
ZBS2503250	25, 26	25	22.5	100	250	Long		
ZBS250001P	25, 26	25	22.5	90	200	Long		
ZBS250002P	25, 26	25	22.5	60	200	Long		
★ ZBS3001320	30, 32, 33	32	27.0	55	140	Short		
★ ZBS3002320	30, 32, 33	32	27.0	110	195	Regular	● TWBT30	TX8030T30
ZBS3004320	30, 32, 33	32	27.0	150	350	Long		
ZBS300001P	30, 32, 33	32	27.0	100	250	Long		

* ● Required to use T-HANDLE (TWH600)

* ★ Stock Item

i-Xmill STEEL BALL HOLDER - TAPER NECK

🇩🇪 i-Xmill STAHL HALTER für WECHSEL PLATTE mit RUNDER STIRN - mit KONISCH ABGESETZTEM SCHAFTTEIL
🇫🇷 Porte-plaquette i-Xmill en acier, entrée conique, pour plaquette à bout hémisphérique
🇮🇹 CORPO FRESA IN ACCIAIO PER INSERTI SEMISFERICI i-Xmill - CONICO

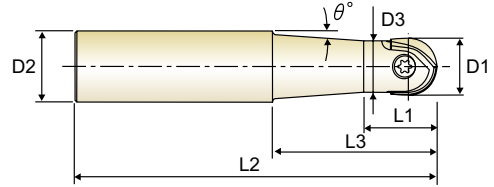

Unit : mm

EDP No.	Mill Diameter	Shank Diameter	Neck Diameter	Length of Cut	Length Below Shank	Overall Length	Interference Angle	Length Type	Wrench No.	Screw No.
	D ₁	D ₂	D ₃	L ₁	L ₃	L ₂	θ°			
★ ZBT0801120	8	12	7.2	12	35	90	4° 43'	Short	TWFT07	TX2508T07
★ ZBT0802120	8	12	7.2	25	55	110	3° 37'	Regular		
★ ZBT1001120	10, 11	12	9.0	15	35	90	2° 51'	Short	TWFT08	TX3010T08
★ ZBT1002120	10, 11	12	9.0	30	55	110	2° 17'	Regular		
★ ZBT1201160	12, 13	16	10.5	17	55	110	3° 23'	Short	TWFT10	TX3512T10
★ ZBT1601200	16, 17	20	14.5	20	65	125	2° 51'	Short		
ZBT1604200	16, 17	20	14.5	20	115	200	1° 22'	Regular	TWFT15	TX4016T15
★ ZBT2001250	20, 21	25	18.0	25	75	145	3° 26'	Short		
ZBT2004250	20, 21	25	18.0	25	115	200	1° 55'	Regular	TWBT20	TX5020T20
ZBT2005250	20, 21	25	18.0	25	160	250	1° 17'	Long		
★ ZBT2501320	25, 26	32	22.5	30	90	170	4° 03'	Short	TWBT25	TX6025T25
ZBT2504320	25, 26	32	22.5	30	160	250	1° 53'	Regular		
ZBT2505320	25, 26	32	22.5	30	190	300	1° 32'	Long	TWBT30	TX8030T30
★ ZBT3001320	30,32,33	32	27.0	40	110	195	1° 38'	Short		
ZBT3004320	30,32,33	32	27.0	40	160	250	0° 58'	Regular	TWBT30	TX8030T30
ZBT3005320	30,32,33	32	27.0	40	190	300	0° 46'	Long		

* ● Required to use T-HANDLE (TWH600)

* ★ Stock Item

i-Xmill CARBIDE CORNER RADIUS HOLDER - STRAIGHT NECK

- i-Xmill HARTMETAL HALTER für WECHSEL PLATTE mit ECKRADIUS - mit GERADER SCHAFT
- Ⓛ Porte-plaquette i-Xmill en Carbure, entrée droite, pour plaquette à bout torique
- Ⓛ CORPO FRESA IN MD PER INSERTI TORICI i-Xmill - CILINDRICO

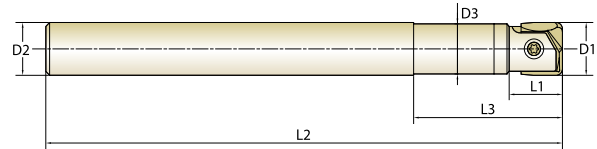

Unit : mm

EDP No.	Mill Diameter	Shank Diameter	Neck Diameter	Length of Cut	Length Below Shank	Overall Length	Length Type	Wrench No.	Screw No.
	D ₁	D ₂	D ₃	L ₁	L ₃	L ₂			
★ ZRC0801080	8	8	7.6	12	25	130	Regular	TWFT07	TX2508T07
★ ZRC0802080	8	8	7.6	12	40	130	Regular		
★ ZRC0803080	8	8	7.6	12	65	130	Regular		
★ ZRC1001100	10	10	9.5	15	30	140	Regular	TWFT08	TX3010T08
★ ZRC1002100	10	10	9.5	15	50	140	Regular		
★ ZRC1003100	10	10	9.5	15	75	140	Regular		
★ ZRC1201120	12, 13	12	11.4	17	35	150	Regular	TWFT10	TX3512T10
★ ZRC1202120	12, 13	12	11.4	17	60	150	Regular		
★ ZRC1203120	12, 13	12	11.4	17	85	150	Regular		
★ ZRC1601160	16, 17	16	15.0	20	50	200	Long	TWFT15	TX4016T15
★ ZRC1602160	16, 17	16	15.0	20	80	200	Long		
★ ZRC1603160	16, 17	16	15.0	20	120	200	Long		
★ ZRC1604160	16, 17	16	15.0	20	80	250	Long		
★ ZRC2001200	20, 21	20	19.0	25	60	200	Regular	● TWBT20	TX5020T20
★ ZRC2002200	20, 21	20	19.0	25	80	250	Regular		
★ ZRC2003200	20, 21	20	19.0	25	100	250	Long		
★ ZRC2004200	20, 21	20	19.0	25	150	250	Long	● TWBT25	TX6025T25
★ ZRC2501250	25, 26	25	24.0	30	75	200	Regular		
★ ZRC2502250	25, 26	25	24.0	30	120	250	Regular		
★ ZRC2503250	25, 26	25	24.0	30	190	300	Long	● TWBT30	TX8030T30
★ ZRC3001320	30, 32, 33	32	29.0	40	90	250	Regular		
★ ZRC3002320	30, 32, 33	32	29.0	40	150	300	Long		
★ ZRC3003320	30, 32, 33	32	29.0	40	190	300	Long		

* ● Required to use T-HANDLE (TWH600)

* ★ Stock Item

i-Xmill STEEL CORNER RADIUS HOLDER - STRAIGHT NECK

- i-Xmill STAHL HALTER für WECHSEL PLATTE mit ECKRADIUS - mit GERADER SCHAFT
- 🇫🇷 Porte-plaquette i-Xmill en acier, entrée droite, pour plaquette torique
- 🇮🇹 CORPO FRESA IN ACCIAIO PER INSERTI TORICI i-Xmill - CILINDRICO

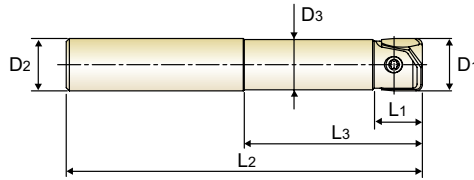

Unit : mm

EDP No.	Mill Diameter	Shank Diameter	Neck Diameter	Length of Cut	Length Below Shank	Overall Length	Length Type	Wrench No.	Screw No.
	D ₁	D ₂	D ₃	L ₁	L ₃	L ₂			
★ ZRS1201120	12, 13	12	11.0	13	30	110	Regular	TWFT10	TX3512T10
★ ZRS1601160	16, 17	16	15.0	15	50	130	Regular		
★ ZRS1602160	16, 17	16	15.0	15	65	165	Intermediate	TWFT15	TX4016T15
ZRS1603160	16, 17	16	15.0	15	65	200	Long		
★ ZRS2001200	20, 21	20	19.0	18	60	140	Regular		
★ ZRS2002200	20, 21	20	19.0	18	80	180	Intermediate	● TWBT20	TX5020T20
ZRS2003200	20, 21	20	19.0	18	80	250	Long		
★ ZRS2501250	25, 26	25	24.0	23	70	150	Regular	● TWBT25	TX6025T25
★ ZRS2502250	25, 26	25	24.0	23	90	200	Intermediate		
ZRS2503250	25, 26	25	24.0	23	90	300	Long		
★ ZRS3001320	30, 32, 33	32	29.0	27	80	160	Regular	● TWBT30	TX8030T30
★ ZRS3002320	30, 32, 33	32	29.0	27	100	220	Intermediate		
ZRS3003320	30, 32, 33	32	29.0	27	100	350	Long		

- * ● Required to use T-HANDLE (TWH600)
- * ★ Stock Item

i-Xmill STEEL CORNER RADIUS HOLDER - TAPER NECK

- i-Xmill STAHL HALTER für WECHSEL PLATTE mit ECKRADIUS - mit KONISCH ABGESETZTEM SCHAFTTEIL
- 🇫🇷 Porte-plaquette i-Xmill en acier, entrée conique, pour plaquette torique
- 🇮🇹 CORPO FRESA IN ACCIAIO PER INSERTI TORICI i-Xmill - CONICO

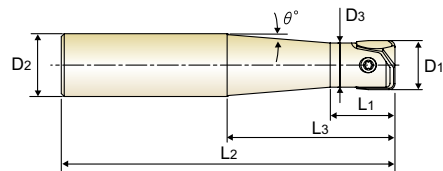

Unit : mm

EDP No.	Mill Diameter	Shank Diameter	Neck Diameter	Length of Cut	Length Below Shank	Overall Length	Interference Angle	Length Type	Wrench No.	Screw No.
	D ₁	D ₂	D ₃	L ₁	L ₃	L ₂	θ°			
★ ZRT0801120	8	12	6.7	10	22	100	9°	Regular	TWFT07	TX2508T07
★ ZRT0802120	8	12	6.7	10	50	130	2° 43'	Long		
★ ZRT1001120	10, 11	12	8.6	13	25	100	4° 45'	Regular	TWFT08	TX3010T08
★ ZRT1002120	10, 11	12	8.6	13	50	150	1° 32'	Long		
★ ZRT1202160	12, 13	16	10.2	15	60	160	2° 32'	Long	TWFT10	TX3512T10

- * ★ Stock Item

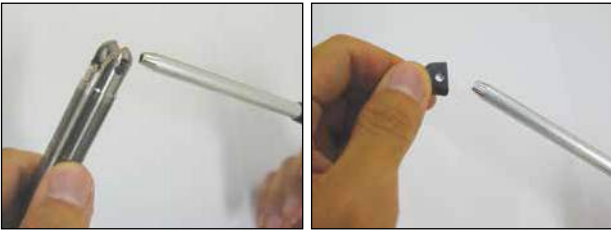
**ASSEMBLY of i-Xmill
MONTAGE DES i-Xmill**

▲ Make sure to clean the insert and insert seat.
Wechselplatte und Plattensitz sorgfältig reinigen.

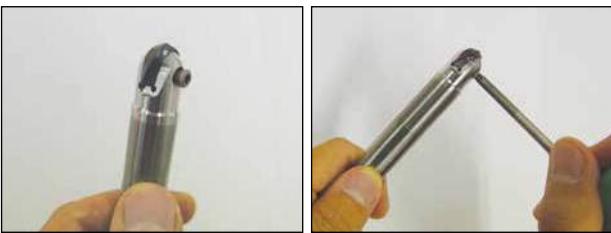

▲ Slide the insert into the slot of the holder.
Tighten the screw using anti-seize compound.
Wechselplatte in den Sitz des Halters einführen.
Die Schraube fest anziehen und dabei Spezialfett verwenden

SIZE (ØD)	CLAMPING TORQUE [N·m]
Ø8.0	1.0
Ø10.0	1.5
Ø12.0, Ø13.0	2.5
Ø16.0, Ø17.0	3.5
Ø20.0, Ø21.0	5.0
Ø25.0, Ø26.0	6.0
Ø30.0, Ø32.0	6.5

- * When the screw is worn out, please change the a new screw.
* Wenn das Schraubengewinde verschlissen ist, bitte neue Schraube verwenden.
- * Please tighten up the screw with recommended torque.
(Please refer to the table)
* Die Feststellschraube mit dem empfohlenen Anzugsmoment anziehen (siehe Tabelle).
- * Don't press down the insert, when the screw is tightened.
* Die Wechselplatte nicht nach unten drücken, wenn die Schraube angezogen ist.

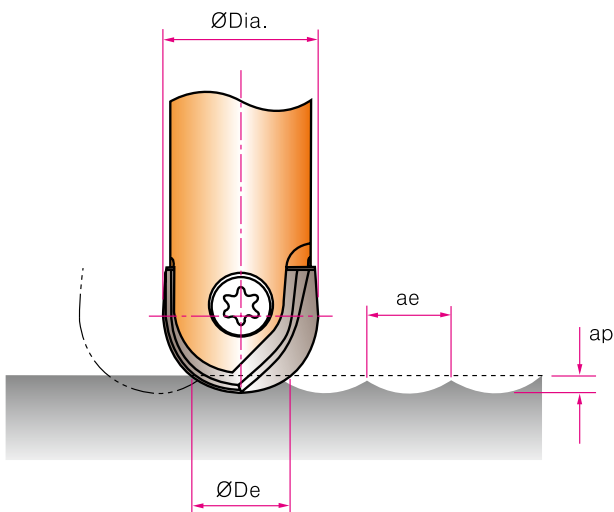
**CUTTING CONDITION
SCHNEIDKONDITIONEN**

RPM = revolution per minute (rev/min)
Vc = surface meter per minute (M/min)
Dia. = diameter of insert (mm)
Vf = feed speed (mm/min)
f = feed per revolution (mm/rev)
De = effective tool diameter (mm)
ap = axial depth of cut (mm)
ae = radial depth of cut (mm)

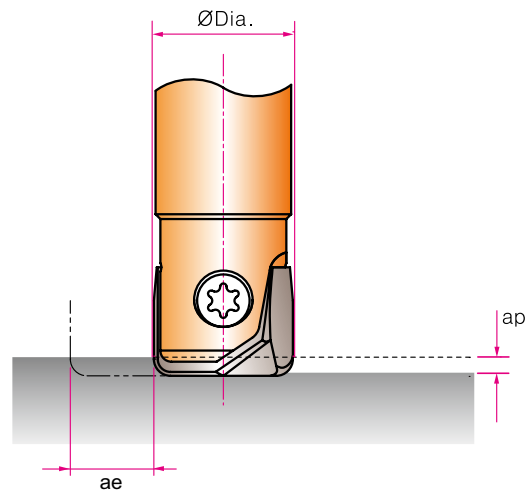

$$Vc [M/min] = \frac{(RPM) \cdot (\pi) \cdot (Dia.)}{1000}$$

$$Vf [mm/min] = (RPM) \cdot (f)$$

$$RPM [rev/min] = \frac{(Vc) \cdot (1000)}{(\pi) \cdot (Dia.)}$$

$$De [mm] = 2 \sqrt{ap \cdot (Dia. - ap)}$$

XMB110A SERIES
BALL INSERTS for GENERAL PURPOSE

 Vc = m/min.
 Fz = mm/tooth
 RPM = rev./min.
 FEED = mm/min.

ISO	VDI 3323	Material Description	Parameter	Diameter (Ø)							
				8	10, 11	12, 13	16, 17	20, 21	25, 26	30, 32, 33	
P	1-4	Non-alloy steel	Vc	160~320	160~360	160~380	160~480	160~580	160~600	160~700	
			fz	0.20~0.20	0.20~0.20	0.20~0.20	0.25~0.30	0.25~0.40	0.25~0.50	0.25~0.60	
			RPM	6370~12730	5090~11460	4240~10080	3180~9550	2550~9230	2040~7640	1700~7430	
			FEED	2550~5090	2040~4580	1700~4030	1590~5730	1270~7380	1020~7640	850~8910	
			Vc	120~280	120~300	120~350	120~380	120~420	120~480	120~550	
			fz	0.20~0.20	0.20~0.20	0.20~0.20	0.25~0.30	0.25~0.40	0.25~0.50	0.25~0.60	
	5	Non-alloy steel	RPM	4770~11140	3820~9550	3180~9280	2390~7560	1910~6680	1530~6110	1270~5840	
			FEED	1910~4460	1530~3820	1270~3710	1190~4540	950~5350	760~6110	640~7000	
			Vc	160~320	160~360	160~380	160~480	160~580	160~600	160~700	
			fz	0.20~0.20	0.20~0.20	0.20~0.20	0.25~0.30	0.25~0.40	0.25~0.50	0.25~0.60	
			RPM	6370~12730	5090~11460	4240~10080	3180~9550	2550~9230	2040~7640	1700~7430	
			FEED	2550~5090	2040~4580	1700~4030	1590~5730	1270~7380	1020~7640	850~8910	
6-7	Low alloy steel	Vc	120~280	120~300	120~350	120~380	120~420	120~480	120~550		
		fz	0.20~0.20	0.20~0.20	0.20~0.20	0.25~0.30	0.25~0.40	0.25~0.50	0.25~0.60		
		RPM	4770~11140	3820~9550	3180~9280	2390~7560	1910~6680	1530~6110	1270~5840		
		FEED	1910~4460	1530~3820	1270~3710	1190~4540	950~5350	760~6110	640~7000		
		Vc	160~320	160~360	160~380	160~480	160~580	160~600	160~700		
		fz	0.20~0.20	0.20~0.20	0.20~0.20	0.25~0.30	0.25~0.40	0.25~0.50	0.25~0.60		
8	Low alloy steel	RPM	6370~12730	5090~11460	4240~10080	3180~9550	2550~9230	2040~7640	1700~7430		
		FEED	2550~5090	2040~4580	1700~4030	1590~5730	1270~7380	1020~7640	850~8910		
		Vc	120~280	120~300	120~350	120~380	120~420	120~480	120~550		
		fz	0.20~0.20	0.20~0.20	0.20~0.20	0.25~0.30	0.25~0.40	0.25~0.50	0.25~0.60		
		RPM	4770~11140	3820~9550	3180~9280	2390~7560	1910~6680	1530~6110	1270~5840		
		FEED	1910~4460	1530~3820	1270~3710	1190~4540	950~5350	760~6110	640~7000		

XMB120C SERIES
BALL INSERTS for PRE-HARDENED STEELS

ISO	VDI 3323	Material Description	Parameter	Diameter (Ø)							
				8	10, 11	12, 13	16, 17	20, 21	25, 26	30, 32, 33	
P	9-11	Low alloy steel High alloyed steel, and tool steel	Vc	100~220	100~260	100~280	100~350	100~400	100~450	100~500	
			fz	0.15~0.20	0.15~0.20	0.15~0.20	0.20~0.30	0.20~0.40	0.20~0.50	0.20~0.60	
			RPM	3980~8750	3180~8280	2650~7430	1990~6960	1590~6370	1270~5730	1060~5310	
			FEED	1190~3500	950~3310	800~2970	800~4180	640~5090	510~5730	420~6370	
K	15-20	Grey cast iron Nodular cast iron Malleable cast iron	Vc	160~320	160~360	160~400	160~500	160~550	160~620	160~720	
			fz	0.30~0.30	0.30~0.30	0.30~0.30	0.35~0.40	0.35~0.40	0.35~0.50	0.35~0.60	
			RPM	6370~12730	5090~11460	4240~10610	3180~9950	2550~8750	2040~7890	1700~7640	
			FEED	3820~7640	3060~6880	2550~6370	2230~7960	1780~7000	1430~7890	1190~9170	
H	38	Hardened steel	Vc	80~180	80~200	80~220	80~260	80~320	80~360	80~400	
			fz	0.10~0.20	0.10~0.20	0.10~0.20	0.15~0.30	0.15~0.40	0.15~0.50	0.15~0.60	
			RPM	3180~7160	2550~6370	2120~5840	1590~5170	1270~5090	1020~4580	850~4240	
			FEED	640~2860	510~2550	420~2330	480~3100	380~4070	310~4580	250~5090	

XMB260T SERIES
BALL INSERTS for HIGH HARDENED STEELS

ISO	VDI 3323	Material Description	Parameter	Diameter (Ø)							
				8	10, 11	12, 13	16, 17	20, 21	25, 26	30, 32, 33	
H	38-41	Hardened steel	Vc	80~180	80~200	80~220	80~260	80~320	80~360	80~400	
			fz	0.10~0.15	0.10~0.15	0.10~0.15	0.15~0.25	0.15~0.25	0.15~0.25	0.15~0.30	
			RPM	3180~7160	2550~6370	2120~5840	1590~5170	1270~5090	1020~4580	850~4240	
			FEED	640~2150	510~1910	420~1750	480~2590	380~2550	310~2290	250~2550	

XMB130A SERIES
BALL INSERTS for STAINLESS STEELS

ISO	VDI 3323	Material Description	Parameter	Diameter (Ø)							
				8	10, 11	12, 13	16, 17	20, 21	25, 26	30, 32, 33	
M	12-14	Stainless steel	Vc	90~130	90~130	90~130	90~130	90~130	90~130	90~130	
			fz	0.10~0.12	0.13~0.15	0.15~0.20	0.15~0.20	0.15~0.20	0.20~0.25	0.20~0.25	
			RPM	3580~5170	2860~4140	2390~3450	1790~2590	1430~2070	1150~1660	950~1380	
			FEED	720~1290	720~1240	720~1380	540~1030	430~830	460~830	380~690	

Vc = m/min.
Fz = mm/tooth
RPM = rev./min.
FEED = mm/min.

XMM110V SERIES
BALL INSERTS for GENERAL PURPOSE - FULL RADIUS

ISO	VDI 3323	Material Description	Parameter	Diameter (Ø)						
				8	10, 11	12, 13	16, 17	20, 21	25, 26	30, 32, 33
P	1-4	Non-alloy steel	Vc	160~320	160~360	160~380	160~480	160~580	160~600	160~700
			fz	0.20~0.20	0.20~0.20	0.20~0.20	0.25~0.30	0.25~0.40	0.25~0.50	0.25~0.60
			RPM	6370~12730	5090~11460	4240~10080	3180~9550	2550~9230	2040~7640	1700~7430
	6-7	Low alloy steel	FEED	2550~5090	2040~4580	1700~4030	1590~5730	1270~7380	1020~7640	850~8910
			Vc	160~320	160~360	160~380	160~480	160~580	160~600	160~700
			fz	0.20~0.20	0.20~0.20	0.20~0.20	0.25~0.30	0.25~0.40	0.25~0.50	0.25~0.60
	10	High alloyed steel, and tool steel	RPM	6370~12730	5090~11460	4240~10080	3180~9550	2550~9230	2040~7640	1700~7430
			FEED	2550~5090	2040~4580	1700~4030	1590~5730	1270~7380	1020~7640	850~8910
			Vc	160~320	160~360	160~380	160~480	160~580	160~600	160~700
fz	0.20~0.20	0.20~0.20	0.20~0.20	0.25~0.30	0.25~0.40	0.25~0.50	0.25~0.60			
RPM	6370~12730	5090~11460	4240~10080	3180~9550	2550~9230	2040~7640	1700~7430			
FEED	2550~5090	2040~4580	1700~4030	1590~5730	1270~7380	1020~7640	850~8910			

XMB110D SERIES
BALL INSERTS for GRAPHITE

ISO	VDI 3323	Material Description	Parameter	Diameter (Ø)						
				8	10, 11	12, 13	16, 17	20, 21	25, 26	30, 32, 33
N	21~22	Aluminum-wrought alloy	Vc	300~400	300~400	300~400	300~400	300~480	300~560	300~650
			fz	0.20~0.20	0.20~0.20	0.20~0.20	0.25~0.30	0.30~0.35	0.35~0.40	0.40~0.50
			RPM	11940~15920	9550~12730	7960~10610	5970~7960	4770~7640	3820~7130	3180~6900
	23~24	Aluminum-cast, alloyed	FEED	4770~6370	3820~5090	3180~4240	2980~4770	2860~5350	2670~5700	2550~6900
			Vc	300~400	300~400	300~400	300~400	300~480	300~560	300~650
			fz	0.20~0.20	0.20~0.20	0.20~0.20	0.25~0.30	0.30~0.35	0.35~0.40	0.40~0.50
	29.2	Graphite	RPM	11940~15920	9550~12730	7960~10610	5970~7960	4770~7640	3820~7130	3180~6900
			FEED	4770~6370	3820~5090	3180~4240	2980~4770	2860~5350	2670~5700	2550~6900
			Vc	300~400	300~400	300~400	300~400	300~480	300~560	300~650
fz	0.20~0.20	0.20~0.20	0.20~0.20	0.25~0.30	0.30~0.35	0.35~0.40	0.40~0.50			
RPM	11940~15920	9550~12730	7960~10610	5970~7960	4770~7640	3820~7130	3180~6900			
FEED	4770~6370	3820~5090	3180~4240	2980~4770	2860~5350	2670~5700	2550~6900			

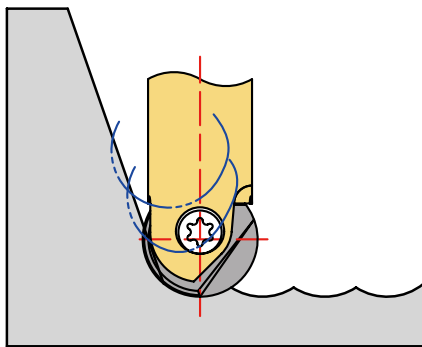
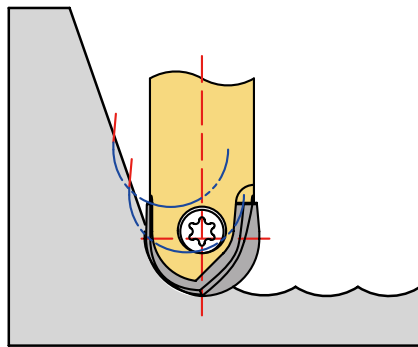
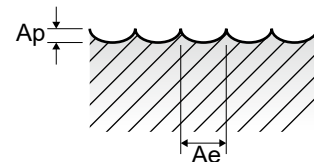
Full Radius Type

Ball Radius Type

ae : Roughing - 0.1 x D
 Finishing - Under Ø12 : 0.25mm
 Under Ø20 : 0.30mm
 From Ø20 : 0.40mm

ap : Roughing - Under Ø16 : 0.025 x D
 From Ø16 : 0.05 x D
 Finishing - Under Ø16 : 0.1mm

- ▶ When the length of overhang exceed 4xD, we recommend to use carbide shank holder. (Feed 20% down)
- ▶ Recommend to reduce the feed rate to 70~85% when you use long(long & intermediate Type Holder) tools.



RECOMMENDED CUTTING CONDITIONS
EMPFOHLENE SCHNEIDPARAMETER

XMR110A SERIES CORNER RADIUS INSERTS for GENERAL PURPOSE & STAINLESS STEELS

Vc = m/min.
Fz = mm/tooth
RPM = rev./min.
FEED = mm/min.

ISO	VDI 3323	Material Description	Parameter	Diameter (Ø)							
				8	10, 11	12, 13	16, 17	20, 21	25, 26	30, 32, 33	
P	1-4	Non-alloy steel	Vc	160~300	160~300	160~300	160~300	160~300	160~300	160~300	160~300
			fz	0.20~0.15	0.20~0.15	0.20~0.15	0.25~0.20	0.25~0.20	0.25~0.20	0.25~0.20	0.25~0.20
			RPM	6370~11940	5090~9550	4240~7960	3180~5970	2550~4770	2040~3820	1700~3180	1700~3180
			FEED	2550~3580	2040~2860	1700~2390	1590~2390	1270~1910	1020~1530	850~1270	850~1270
			Vc	120~280	120~280	120~280	120~280	120~280	120~280	120~280	120~280
			fz	0.20~0.15	0.20~0.15	0.20~0.15	0.25~0.20	0.25~0.20	0.25~0.20	0.25~0.20	0.25~0.20
	5	Non-alloy steel	RPM	4770~11140	3820~8910	3180~7430	2390~5570	1910~4460	1530~3570	1270~2970	
			FEED	1910~3340	1530~2670	1270~2230	1190~2230	950~1780	760~1430	640~1190	
			Vc	160~300	160~300	160~300	160~300	160~300	160~300	160~300	
			fz	0.20~0.15	0.20~0.15	0.20~0.15	0.25~0.20	0.25~0.20	0.25~0.20	0.25~0.20	
			RPM	6370~11940	5090~9550	4240~7960	3180~5970	2550~4770	2040~3820	1700~3180	
			FEED	2550~3580	2040~2860	1700~2390	1590~2390	1270~1910	1020~1530	850~1270	
6-7	Low alloy steel	Vc	120~280	120~280	120~280	120~280	120~280	120~280	120~280		
		fz	0.20~0.15	0.20~0.15	0.20~0.15	0.25~0.20	0.25~0.20	0.25~0.20	0.25~0.20		
		RPM	4770~11140	3820~8910	3180~7430	2390~5570	1910~4460	1530~3570	1270~2970		
		FEED	1910~3340	1530~2670	1270~2230	1190~2230	950~1780	760~1430	640~1190		
		Vc	160~300	160~300	160~300	160~300	160~300	160~300	160~300		
		fz	0.20~0.15	0.20~0.15	0.20~0.15	0.25~0.20	0.25~0.20	0.25~0.20	0.25~0.20		
8	Low alloy steel	RPM	4770~11140	3820~8910	3180~7430	2390~5570	1910~4460	1530~3570	1270~2970		
		FEED	1910~3340	1530~2670	1270~2230	1190~2230	950~1780	760~1430	640~1190		
		Vc	90~130	90~130	90~130	90~130	90~130	90~130	90~130		
		fz	0.10~0.10	0.11~0.11	0.12~0.11	0.13~0.13	0.13~0.13	0.13~0.12	0.13~0.12		
		RPM	3580~5170	2860~4140	2390~3450	1790~2590	1430~2070	1150~1660	950~1380		
		FEED	720~1030	630~910	550~790	450~650	360~520	290~410	240~340		
M	12-14	Stainless steel	Vc	90~130	90~130	90~130	90~130	90~130	90~130		
			fz	0.10~0.10	0.11~0.11	0.12~0.11	0.13~0.13	0.13~0.13	0.13~0.12		
			RPM	3580~5170	2860~4140	2390~3450	1790~2590	1430~2070	1150~1660		
			FEED	720~1030	630~910	550~790	450~650	360~520	290~410		

XMR120C SERIES CORNER RADIUS INSERTS for PRE-HARDENED STEELS

ISO	VDI 3323	Material Description	Parameter	Diameter (Ø)							
				8	10, 11	12, 13	16, 17	20, 21	25, 26	30, 32, 33	
P	9-11	Low alloy steel High alloyed steel, and tool steel	Vc	100~280	100~280	100~280	100~280	100~280	100~280	100~280	
			fz	0.12~0.06	0.13~0.06	0.13~0.06	0.15~0.08	0.15~0.08	0.15~0.08	0.15~0.08	
			RPM	3980~11140	3180~8910	2650~7430	1990~5570	1590~4460	1270~3570	1060~2970	
			FEED	990~1340	800~1070	690~890	600~840	480~670	380~570	320~450	
K	15-20	Grey cast iron Nodular cast iron Malleable cast iron	Vc	160~380	160~380	160~380	160~380	160~380	160~380	160~380	
			fz	0.30~0.20	0.30~0.20	0.30~0.20	0.35~0.30	0.35~0.30	0.35~0.30	0.35~0.30	
			RPM	6370~15120	5090~12100	4240~10080	3180~7560	2550~6050	2040~4840	1700~4030	
			FEED	3820~6050	3060~4840	2550~4030	2230~4540	1780~3630	1430~2900	1190~2420	
H	38	Hardened steel	Vc	80~220	80~220	80~220	80~220	80~220	80~220	80~220	
			fz	0.10~0.05	0.10~0.05	0.10~0.05	0.15~0.06	0.15~0.06	0.15~0.06	0.15~0.06	
			RPM	3180~8750	2550~7000	2120~5840	1590~4380	1270~3500	1020~2800	850~2330	
			FEED	640~880	510~700	420~580	420~530	380~420	310~340	250~280	

XMR260T SERIES CORNER RADIUS INSERTS for HIGH HARDENED STEELS

ISO	VDI 3323	Material Description	Parameter	Diameter (Ø)							
				8	10, 11	12, 13	16, 17	20, 21	25, 26	30, 32, 33	
H	38-41	Hardened steel	Vc	80~220	80~220	80~220	80~220	80~220	80~220	80~220	
			fz	0.10~0.05	0.10~0.05	0.10~0.05	0.15~0.06	0.15~0.06	0.15~0.06	0.15~0.06	
			RPM	3180~8750	2550~7000	2120~5840	1590~4380	1270~3500	1020~2800	850~2330	
			FEED	640~880	510~700	420~580	480~530	380~420	310~340	250~280	

Vc = m/min.
Fz = mm/tooth
RPM = rev./min.
FEED = mm/min.

XMF110V SERIES **CORNER RADIUS INSERTS for GENERAL PURPOSE - HIGH FEED**

ISO	VDI 3323	Material Description	Parameter	Diameter (Ø)						
				8	10, 11	12, 13	16, 17	20, 21	25, 26	30, 32, 33
P	1-7	Non-alloy steel Low alloy steel	Vc	150~200	150~200	150~200	150~200	150~200	150~200	150~200
			fz	0.60~0.40	0.75~0.50	0.90~0.60	1.20~0.80	1.50~1.00	1.80~1.40	2.30~1.80
			RPM	5970~7960	4770~6370	3980~5310	2980~3980	2390~3180	1910~2550	1590~2120
		FEED	7160~6370	7160~6370	7160~6370	7160~6370	7160~6370	6880~7140	7320~7640	
		Ap(Max)	0.4	0.5	0.6	0.8	1.0	1.3	1.6	
		10	High alloyed steel, and tool steel	Vc	150~200	150~200	150~200	150~200	150~200	150~200
fz	0.60~0.40			0.75~0.50	0.90~0.60	1.20~0.80	1.50~1.00	1.80~1.40	2.30~1.80	
RPM	5970~7960			4770~6370	3980~5310	2980~3980	2390~3180	1910~2550	1590~2120	
FEED	7160~6370			7160~6370	7160~6370	7160~6370	7160~6370	6880~7140	7320~7640	
Ap(Max)	0.4			0.5	0.6	0.8	1.0	1.3	1.6	

XMR110D SERIES **CORNER RADIUS INSERTS for GRAPHITE**

ISO	VDI 3323	Material Description	Parameter	Diameter (Ø)						
				8	10, 11	12, 13	16, 17	20, 21	25, 26	30, 32, 33
N	21~22	Aluminum-wrought alloy	Vc	300~400	300~400	300~400	300~400	300~400	300~400	300~400
			fz	0.20~0.20	0.20~0.20	0.20~0.20	0.20~0.20	0.25~0.25	0.25~0.25	0.25~0.25
			RPM	11940~15920	9550~12730	7960~10610	5970~7960	4770~6370	3820~5090	3180~4240
			FEED	4770~6370	3820~5090	3180~4240	2390~3180	2390~3180	1910~2550	1590~2120
	23~24	Aluminum-cast, alloyed	Vc	300~400	300~400	300~400	300~400	300~400	300~400	300~400
			fz	0.20~0.20	0.20~0.20	0.20~0.20	0.20~0.20	0.25~0.25	0.25~0.25	0.25~0.25
			RPM	11940~15920	9550~12730	7960~10610	5970~7960	4770~6370	3820~5090	3180~4240
			FEED	4770~6370	3820~5090	3180~4240	2390~3180	2390~3180	1910~2550	1590~2120
	29.2	Graphite	Vc	300~400	300~400	300~400	300~400	300~400	300~400	300~400
			fz	0.20~0.20	0.20~0.20	0.20~0.20	0.20~0.20	0.25~0.25	0.25~0.25	0.25~0.25
			RPM	11940~15920	9550~12730	7960~10610	5970~7960	4770~6370	3820~5090	3180~4240
			FEED	4770~6370	3820~5090	3180~4240	2390~3180	2390~3180	1910~2550	1590~2120

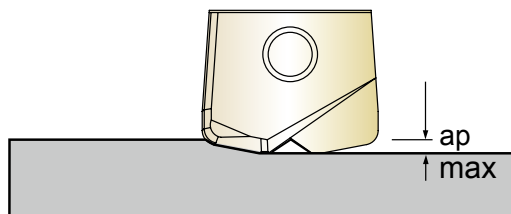

High Feed

ae : Roughing - 0.1 x D
Finishing - 0.2mm
ap : Roughing - Under Ø16 : 0.025 x D
From Ø16 : 0.05 x D
Finishing - Under Ø16 : 0.1mm
From Ø16 : 0.2mm

- ▶ When the length of overhang exceed 4 x D, we recommend to use carbide shank holder. (Feed 20% down)
- ▶ Recommend to reduce the feed rate to 70 ~ 85% when you use long(long & intermediate Type Holder) tools.



Global Cutting Tool Leader **YG-1**



MILLING



Leading Through Innovation

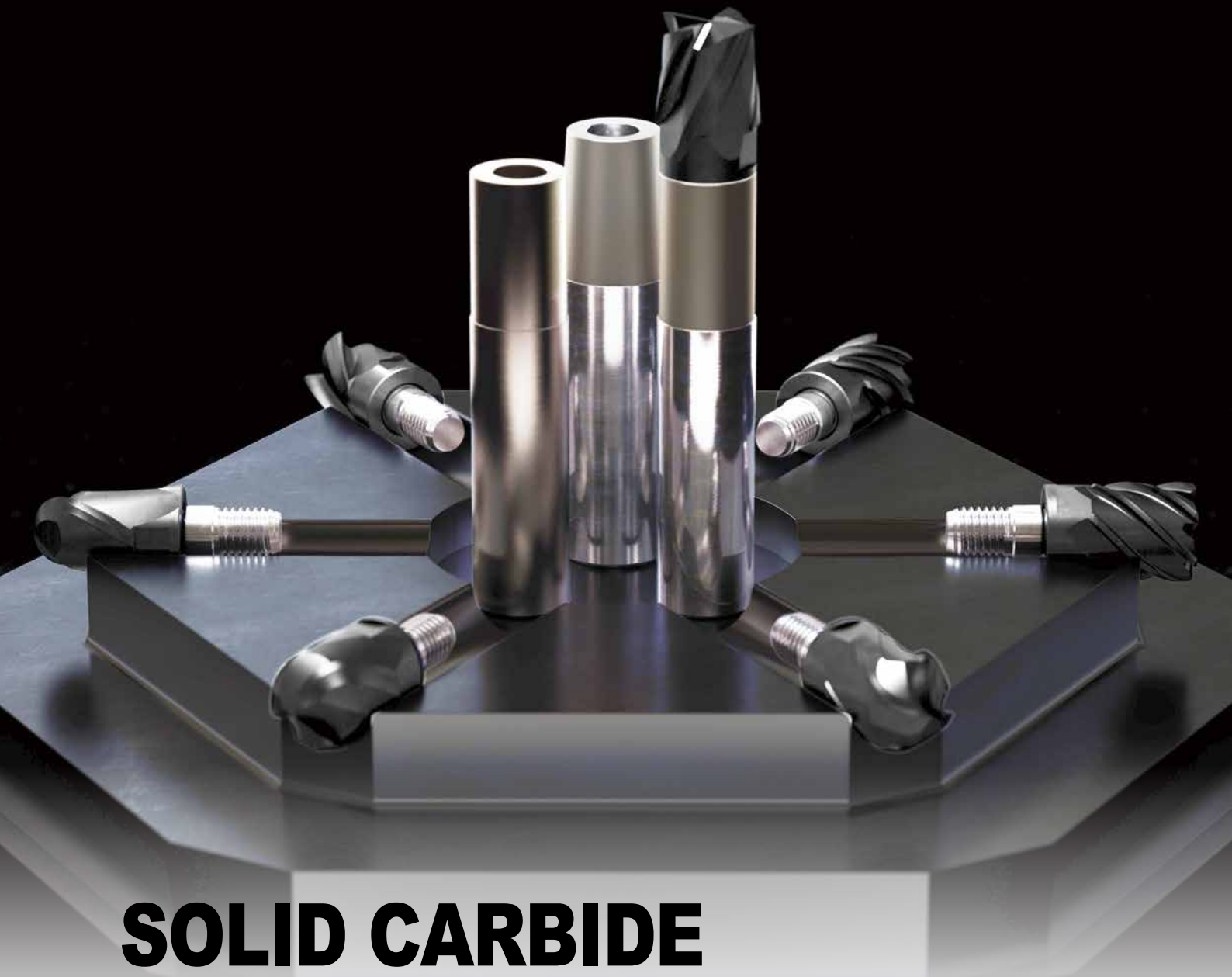

SOLID CARBIDE

***i* - SMART MODULAR TYPE
END MILL**

i-Smart, Schafffräser mit auswechselbaren VHM Schneidköpfen

- For General Steels, Hardened Steels and Cast Iron
- Für allgemeine Stähle, gehärtete Stähle und Gusseisen

SELECTION GUIDE



SERIES	XSEMD98	XSEME59	XSEME60
FLUTE	2	3	4
HELIX ANGLE	30°	30°	30°
CUTTING EDGE SHAPE	BALL NOSE	BALL NOSE	BALL NOSE
SIZE MIN	R5.0	R5.0	R5.0
SIZE MAX	R16.0	R16.0	R16.0
PAGE	84	85	86

CARBIDE MODULAR HEAD & HOLDER *i*-SMART **END MILLS**

Ultra-micro Grain Carbide Heads with Carbide & Steel Holders







Please visit globalyg1.com/mat for material search

◎ : Excellent ○ : Good

Recommended cutting conditions : P 95



ISO	VDI 3323	Material Description	Composition / Structure / Heat Treatment	HB	HRc	CENTER MATCH	Y-Coating	CENTER MATCH	Y-Coating	CENTER MATCH	Y-Coating
P	1	Non-alloy steel	About 0.15% C Annealed	125		○		○		○	
	2		About 0.45% C Annealed	190	13	○		○		○	
	3		About 0.45% C Quenched & Tempered	250	25	○		○		○	
	4		About 0.75% C Annealed	270	28	◎		◎		◎	
	5		About 0.75% C Quenched & Tempered	300	32	◎		◎		◎	
	6	Low alloy steel	Annealed	180	10	○		○		○	
	7		Quenched & Tempered	275	29	◎		◎		◎	
	8		Quenched & Tempered	300	32	◎		◎		◎	
	9		Quenched & Tempered	350	38	◎		◎		◎	
	10		High alloyed steel, and tool steel	Annealed	200	15	○		○		○
	11	Quenched & Tempered		325	35	◎		◎		◎	
M	12	Stainless steel	Ferritic / Martensitic Annealed	200	15						
	13		Martensitic Quenched & Tempered	240	23						
	14		Austenitic	180	10						
K	15	Grey cast iron	Pearlitic / ferritic	180	10	○		○		○	
	16		Pearlitic (Martensitic)	260	26	○		○		○	
	17	Nodular cast iron	Ferritic	160	3	○		○		○	
	18		Pearlitic	250	25	○		○		○	
	19		Ferritic	130		○		○		○	
20	Malleable cast iron	Pearlitic	230	21	○		○		○		
N	21	Aluminum-wrought alloy	Not Curable	60							
	22		Curable Hardened	100							
	23	Aluminum-cast, alloyed	≤ 12% Si, Not Curable	75							
	24		≤ 12% Si, Curable Hardened	90							
	25		> 12% Si, Not Curable	130							
	26	Copper and Copper Alloys (Bronze / Brass)	Cutting Alloys, PB>1%	110							
	27		CuZn, CuSnZn (Brass)	90							
	28		CuSn, lead-free copper and electrolytic copper	100							
	29		Non Metallic Materials	Duroplastic, Fiber Reinforced Plastic							
	30		Rubber, Wood, etc.								
S	31	Heat Resistant Super Alloys	Fe Based Annealed	200	15						
	32		Cured	280	30						
	33		Annealed	250	25						
	34		Ni or Co Based Cured	350	38						
	35	Cast	320	34							
	36	Titanium Alloys	Pure Titanium	400 Rm							
	37		Alpha + Beta Alloys Hardened	1050 Rm							
H	38	Hardened steel	Hardened	550	55	○		○		○	
	39		Hardened	630	60	○		○		○	
	40	Chilled Cast Iron	Cast	400	42	◎		◎		◎	
	41	Hardened Cast Iron	Hardened	550	55	○		○		○	

XSEME01	XSEME68	XSEME36	XSEME75	ZMC	ZMS	ZMT
4	6	4	6	-	-	-
27°/30° (MULTIPLE HELIX)	45°	27°/30° (MULTIPLE HELIX)	45°	-	-	-
CORNER RADIUS	CORNER RADIUS	SQUARE	SQUARE	-	-	-
D10.0	D10.0	D10.0	D10.0	-	-	-
D32.0	D32.0	D32.0	D32.0	-	-	-
87	89	90	91	92	93	94
-	-	-	-	STRAIGHT NECKTYPE	STRAIGHT NECKTYPE	TAPER NECKTYPE
Y-Coating	Y-Coating	Y-Coating	Y-Coating	Carbide	Steel	Steel
						
○	○	○	○			1
○	○	○	○			2
◎	○	◎	◎			3
◎	◎	◎	◎			4
◎	◎	◎	◎			5
○	○	○	○			6
◎	◎	◎	◎			7
◎	◎	◎	◎			8
◎	◎	◎	◎			9
○	○	○	○			10
◎	◎	◎	◎			11
						12
						13
		○				14
○	○	○	○			15
○	○	○	○			16
○	○	○	○			17
○	○	○	○			18
○	○	○	○			19
○	○	○	○			20
						21
						22
						23
						24
						25
						26
						27
						28
						29
						30
						31
						32
						33
						34
						35
						36
						37
○	○	○	○			38
○	○	○	○			39
◎	◎	◎	◎			40
○	○	○	○			41

HSS

CBN END MILLS

i-Xmill END MILLS

i-SMART MODULAR END MILLS

X5070 END MILLS

4G MILL END MILLS

X-POWER PRO END MILLS

TitaNox-POWER END MILLS

JET-POWER END MILLS

V7 PLUS END MILLS

ALU-POWER HPC END MILLS

ALU-POWER END MILLS

D-POWER GRAPHITE END MILLS

D-POWER CFRP END MILLS

ROUTERS

CRX S END MILLS

K-2 END MILLS

ONLY ONE COATED PM60 END MILLS

TANK-POWER END MILLS

GENERAL HSS END MILLS

MILLING CUTTERS

TECHNICAL DATA

CARBIDE MODULAR HEAD, 2 FLUTE BALL NOSE (Center Match)

- Vollhartmetall, 2 Schneiden mit Stirnradius (Schneiden Mittelpunkt)
- CARBURE TÊTE MODULAIRE, 2 DENTS À BOUT HÉMISPHERIQUE (Coupe au Centre)
- TESTINA MODULARE IN MD, 2 TAGLIENTI, SEMISFERICA

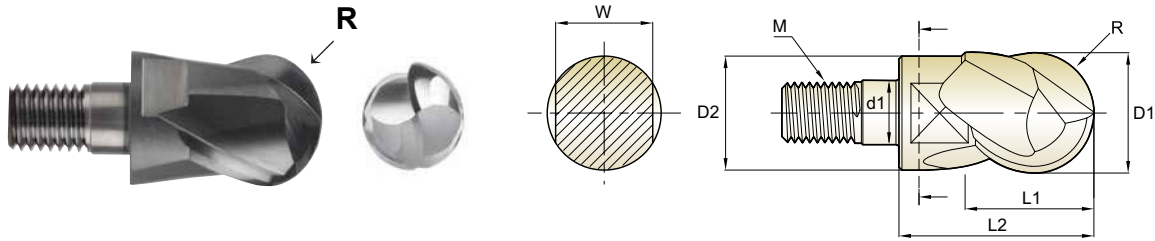

Unit : mm

EDP No.	Radius of Ball Nose	Mill Diameter	Neck Diameter	Length of Cut	Length Below Shank	Wrench Width	Coupling Diameter	Thread
Y-COATED	R	D1	D2	L1	L2	W	d1	M
XSEMD98100	R5.0	10.0	9.2	10	17.5	8	6.5	M6
XSEMD98120	R6.0	12.0	11.2	12	20.5	10	6.5	M6
XSEMD98160	R8.0	16.0	15.0	16	25.5	13	8.5	M8
XSEMD98200	R10.0	20.0	19.0	20	30.0	17	10.5	M10
XSEMD98250	R12.5	25.0	24.0	25	37.0	22	12.5	M12
XSEMD98300	R15.0	30.0	29.0	30	43.0	27	17.0	M16
XSEMD98320	R16.0	32.0	31.0	32	45.0	27	17.0	M16

Radius Tolerance(mm)	Mill Dia. Tolerance(mm)
± 0.010	0 ~ - 0.02

◎ : Excellent ○ : Good

ISO Material Description	P											M				K							
	Non-alloy steel					Low alloy steel						High alloyed steel, and tool steel				Stainless steel				Grey cast iron		Nodular cast iron	
VDI 3323	1	2	3	4	5	6	7	8	9	10	11	12	13	14	15	16	17	18	19	20			
HRc	13	25	28	32	10	29	32	38	15	35	15	23	10	10	26	3	25		21				
HB	125	190	250	270	300	180	275	300	350	200	325	200	240	180	180	260	160	250	130	230			
Recommend	○	○	○	◎	◎	○	◎	◎	◎	○	◎				○	○	○	○	○	○			
ISO Material Description	N										S							H					
	Aluminum-wrought alloy		Aluminum-cast, alloyed			Copper and Copper Alloys (Bronze / Brass)			Non Metallic Materials		Heat Resistant Super Alloys					Titanium Alloys		Hardened steel	Chilled Cast Iron	Hardened Cast Iron			
VDI 3323	21	22	23	24	25	26	27	28	29	30	31	32	33	34	35	36	37	38	39	40	41		
HRc											15	30	25	38	34			55	60	42	55		
HB	60	100	75	90	130	110	90	100			200	280	250	350	320	400 Rm	1050 Rm	550	630	400	550		
Recommend																		○	○	◎	○		

CARBIDE MODULAR HEAD, 3 FLUTE BALL NOSE (Center Match)

- Vollhartmetall, 3 Schneiden mit Stirnradius (Schneiden Mittelpunkt)
- CARBURE TÊTE MODULAIRE, 3 DENTS À BOUT HÉMISPHERIQUE (Coupe au Centre)
- TESTINA MODULARE IN MD, 3 TAGLIENTI, SEMISFERICA

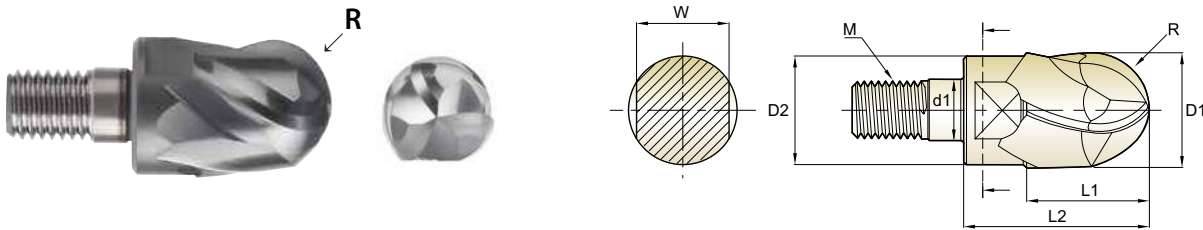

Unit : mm

EDP No.	Radius of Ball Nose	Mill Diameter	Neck Diameter	Length of Cut	Length Below Shank	Wrench Width	Coupling Diameter	Thread
Y-COATED	R	D1	D2	L1	L2	W	d1	M
XSEME59100	R5.0	10.0	9.2	10	17.5	8	6.5	M6
XSEME59120	R6.0	12.0	11.2	12	20.5	10	6.5	M6
XSEME59160	R8.0	16.0	15.0	16	25.5	13	8.5	M8
XSEME59200	R10.0	20.0	19.0	20	30.0	17	10.5	M10
XSEME59250	R12.5	25.0	24.0	25	37.0	22	12.5	M12
XSEME59300	R15.0	30.0	29.0	30	43.0	27	17.0	M16
XSEME59320	R16.0	32.0	31.0	32	45.0	27	17.0	M16

Radius Tolerance(mm)	Mill Dia. Tolerance(mm)
± 0.010	0 ~ - 0.02

◎ : Excellent ○ : Good

ISO Material Description	P										M			K							
	Non-alloy steel					Low alloy steel					High alloyed steel, and tool steel			Stainless steel			Grey cast iron		Nodular cast iron		Malleable cast iron
VDI 3323	1	2	3	4	5	6	7	8	9	10	11	12	13	14	15	16	17	18	19	20	
HRc	13	19	25	28	32	10	29	32	38	15	35	15	23	10	10	26	3	25	42	55	
HB	125	190	250	270	300	180	275	300	350	200	325	200	240	180	180	260	160	250	130	230	
Recommend	○	○	○	◎	◎	○	◎	◎	◎	○	◎				○	○	○	○	○	○	
ISO Material Description	N									S						H					
	Aluminum-wrought alloy		Aluminum-cast, alloyed			Copper and Copper Alloys (Bronze / Brass)			Non Metallic Materials		Heat Resistant Super Alloys						Titanium Alloys		Hardened steel	Chilled Cast Iron	Hardened Cast Iron
VDI 3323	21	22	23	24	25	26	27	28	29	30	31	32	33	34	35	36	37	38	39	40	41
HRc	60	100	75	90	130	110	90	100			15	30	25	38	34	400 Rm	1050 Rm	550	630	400	550
HB	60	100	75	90	130	110	90	100			200	280	250	350	320	400 Rm	1050 Rm	550	630	400	550
Recommend																		○	○	◎	○

CARBIDE MODULAR HEAD, 4 FLUTE BALL NOSE (Center Match)

- Vollhartmetall, 4 Schneiden mit Stirnradius (Schneiden Mittelpunkt)
- CARBURE TÊTE MODULAIRE, 4 DENTS À BOUT HÉMISPHERIQUE (Coupe au Centre)
- TESTINA MODULARE IN MD, 4 TAGLIANTI, SEMISFERICA

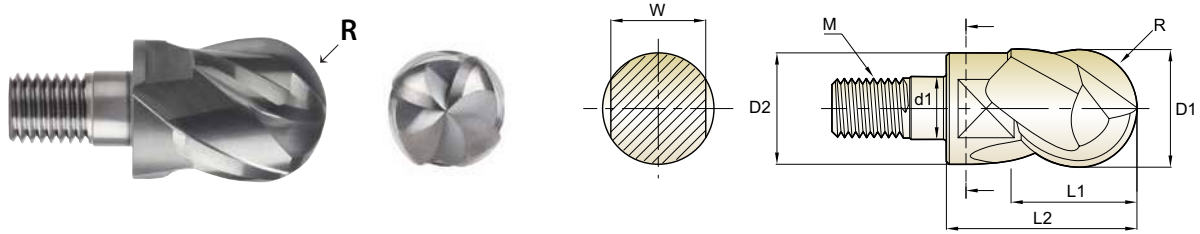

Unit : mm

EDP No.	Radius of Ball Nose	Mill Diameter	Neck Diameter	Length of Cut	Length Below Shank	Wrench Width	Coupling Diameter	Thread
Y-COATED	R	D1	D2	L1	L2	W	d1	M
XSEME60100	R5.0	10.0	9.2	10	17.5	8	6.5	M6
XSEME60120	R6.0	12.0	11.2	12	20.5	10	6.5	M6
XSEME60160	R8.0	16.0	15.0	16	25.5	13	8.5	M8
XSEME60200	R10.0	20.0	19.0	20	30.0	17	10.5	M10
XSEME60250	R12.5	25.0	24.0	25	37.0	22	12.5	M12
XSEME60300	R15.0	30.0	29.0	30	43.0	27	17.0	M16
XSEME60320	R16.0	32.0	31.0	32	45.0	27	17.0	M16

Radius Tolerance(mm)	Mill Dia. Tolerance(mm)
± 0.010	0 ~ - 0.02

◎ : Excellent ○ : Good

ISO Material Description	P											M			K											
	Non-alloy steel					Low alloy steel				High alloyed steel, and tool steel		Stainless steel			Grey cast iron		Nodular cast iron		Malleable cast iron							
VDI 3323	1	2	3	4	5	6	7	8	9	10	11	12	13	14	15	16	17	18	19	20						
HRc	13	25	28	32	10	29	32	38	15	35	15	23	10	10	26	3	25	130	230							
HB	125	190	250	270	300	180	275	300	350	200	325	200	240	180	180	260	160	250	130	230						
Recommend	○	○	○	◎	◎	○	◎	◎	◎	○	◎	○	○	○	○	○	○	○	○	○						
ISO Material Description	N										S							H								
	Aluminum-wrought alloy		Aluminum-cast, alloyed			Copper and Copper Alloys (Bronze / Brass)			Non Metallic Materials		Heat Resistant Super Alloys					Titanium Alloys		Hardened steel	Chilled Cast Iron	Hardened Cast Iron						
VDI 3323	21	22	23	24	25	26	27	28	29	30	31	32	33	34	35	36	37	38	39	40	41					
HRc	60	100	75	90	130	110	90	100			15	30	25	38	34	200	280	250	350	320	400 Rm	1050 Rm	550	630	400	550
HB	60	100	75	90	130	110	90	100			200	280	250	350	320	400 Rm	1050 Rm	550	630	400	550					
Recommend	○	○	○	○	○	○	○	○	○	○	○	○	○	○	○	○	○	○	○	○	○	○	○	○	○	

CARBIDE MODULAR HEAD, 4 FLUTE MULTIPLE HELIX CORNER RADIUS

- Vollhartmetall, 4 Schneiden mit M-Helix und Eckradius
- CARBURE TÊTE MODULAIRE, 4 DENTS TORIQUE, HÉLICE MULTIPLE
- TESTINA MODULARE IN MD, 4 TAGLIENTI, ELICA VARIABILE, TORICA

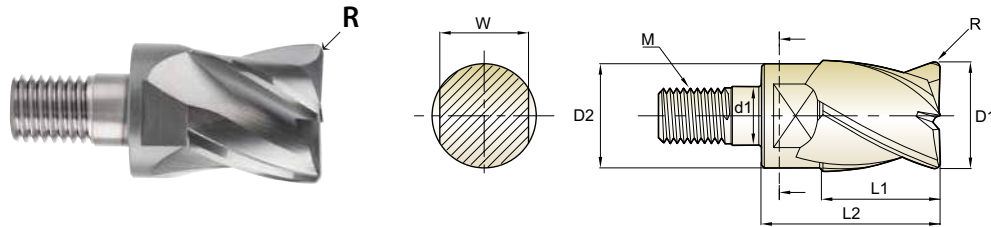

Unit : mm

EDP No.	Corner Radius	Mill Diameter	Neck Diameter	Length of Cut	Length Below Shank	Wrench Width	Coupling Diameter	Thread
Y-COATED	R	D1	D2	L1	L2	W	d1	M
XSEME01100 010	R0.1	10.0	9.2	10	17.5	8	6.5	M6
XSEME01100 020	R0.2	10.0	9.2	10	17.5	8	6.5	M6
XSEME01100 030	R0.3	10.0	9.2	10	17.5	8	6.5	M6
XSEME01100 050	R0.5	10.0	9.2	10	17.5	8	6.5	M6
XSEME01100 100	R1.0	10.0	9.2	10	17.5	8	6.5	M6
XSEME01100 150	R1.5	10.0	9.2	10	17.5	8	6.5	M6
XSEME01100 200	R2.0	10.0	9.2	10	17.5	8	6.5	M6
XSEME01100 250	R2.5	10.0	9.2	10	17.5	8	6.5	M6
XSEME01100 300	R3.0	10.0	9.2	10	17.5	8	6.5	M6
XSEME01100 400	R4.0	10.0	9.2	10	17.5	8	6.5	M6
XSEME01120 010	R0.1	12.0	11.2	12	20.5	10	6.5	M6
XSEME01120 020	R0.2	12.0	11.2	12	20.5	10	6.5	M6
XSEME01120 030	R0.3	12.0	11.2	12	20.5	10	6.5	M6
XSEME01120 050	R0.5	12.0	11.2	12	20.5	10	6.5	M6
XSEME01120 100	R1.0	12.0	11.2	12	20.5	10	6.5	M6
XSEME01120 150	R1.5	12.0	11.2	12	20.5	10	6.5	M6
XSEME01120 200	R2.0	12.0	11.2	12	20.5	10	6.5	M6
XSEME01120 250	R2.5	12.0	11.2	12	20.5	10	6.5	M6
XSEME01120 300	R3.0	12.0	11.2	12	20.5	10	6.5	M6
XSEME01120 400	R4.0	12.0	11.2	12	20.5	10	6.5	M6
XSEME01120 500	R5.0	12.0	11.2	12	20.5	10	6.5	M6
XSEME01160 050	R0.5	16.0	15.0	16	25.5	13	8.5	M8
XSEME01160 100	R1.0	16.0	15.0	16	25.5	13	8.5	M8
XSEME01160 150	R1.5	16.0	15.0	16	25.5	13	8.5	M8

▶ NEXT PAGE

Radius Tolerance(mm)	Mill Dia. Tolerance(mm)
± 0.02	0 ~ - 0.03

◎ : Excellent ○ : Good

ISO Material Description	P											M			K						
	Non-alloy steel					Low alloy steel				High alloyed steel, and tool steel		Stainless steel			Grey cast iron		Nodular cast iron		Malleable cast iron		
VDI 3323	1	2	3	4	5	6	7	8	9	10	11	12	13	14	15	16	17	18	19	20	
HRC		13	25	28	32	10	29	32	38	15	35	15	23	10	10	26	3	25	42	21	
HB	125	190	250	270	300	180	275	300	350	200	325	200	240	180	180	260	160	250	130	230	
Recommend	○	○	◎	◎	◎	○	◎	◎	◎	◎	◎	○	○	○	○	○	○	○	○	○	
ISO Material Description	N									S						H					
	Aluminum-wrought alloy		Aluminum-cast, alloyed			Copper and Copper Alloys (Bronze / Brass)		Non Metallic Materials		Heat Resistant Super Alloys			Titanium Alloys			Hardened steel	Chilled Cast Iron	Hardened Cast Iron			
VDI 3323	21	22	23	24	25	26	27	28	29	30	31	32	33	34	35	36	37	38	39	40	41
HRC											15	30	25	38	34	55	60	55	60	42	55
HB	60	100	75	90	130	110	90	100			200	280	250	350	320	400 Rm	1050 Rm	550	630	400	550
Recommend																		○	○	◎	○

CARBIDE MODULAR HEAD, 4 FLUTE MULTIPLE HELIX CORNER RADIUS

- Vollhartmetall, 4 Schneiden mit M-Helix und Eckradius
- CARBURE TÊTE MODULAIRE, 4 DENTS TORIQUE, HÉLICE MULTIPLE
- TESTINA MODULARE IN MD, 4 TAGLIANTI, ELICA VARIABILE, TORICA

CBN END MILLS

i-Xmill END MILLS

i-SMART MODULAR END MILLS

X5070 END MILLS

4G MILL END MILLS

X-POWER PRO END MILLS

TitaNox-POWER END MILLS

JET-POWER END MILLS

V7 PLUS END MILLS

ALU-POWER HPC END MILLS

ALU-POWER END MILLS

D-POWER GRAPHITE END MILLS

D-POWER CFRP END MILLS

ROUTERS

CRX S END MILLS

K-2 END MILLS

ONLY ONE COATED PM60 END MILLS

TANK-POWER END MILLS

GENERAL HSS END MILLS

MILLING CUTTERS

TECHNICAL DATA

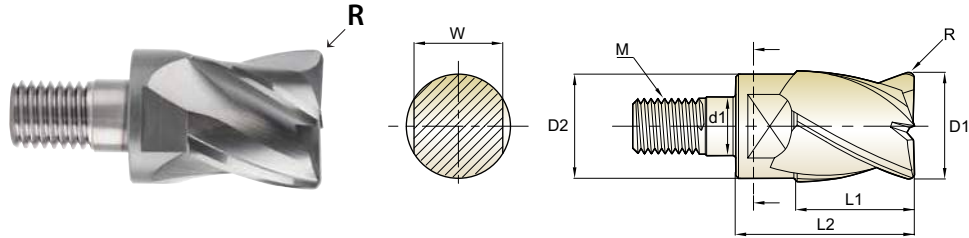

Unit : mm

EDP No.	Corner Radius	Mill Diameter	Neck Diameter	Length of Cut	Length Below Shank	Wrench Width	Coupling Diameter	Thread
Y-COATED	R	D1	D2	L1	L2	W	d1	M
XSEME01160 200	R2.0	16.0	15.0	16	25.5	13	8.5	M8
XSEME01200 050	R0.5	20.0	19.0	20	30.0	17	10.5	M10
XSEME01200 100	R1.0	20.0	19.0	20	30.0	17	10.5	M10
XSEME01200 150	R1.5	20.0	19.0	20	30.0	17	10.5	M10
XSEME01200 200	R2.0	20.0	19.0	20	30.0	17	10.5	M10
XSEME01250 050	R0.5	25.0	24.0	25	37.0	22	12.5	M12
XSEME01250 100	R1.0	25.0	24.0	25	37.0	22	12.5	M12
XSEME01250 150	R1.5	25.0	24.0	25	37.0	22	12.5	M12
XSEME01250 200	R2.0	25.0	24.0	25	37.0	22	12.5	M12
XSEME01300 050	R0.5	30.0	29.0	30	43.0	27	17.0	M16
XSEME01300 100	R1.0	30.0	29.0	30	43.0	27	17.0	M16
XSEME01300 150	R1.5	30.0	29.0	30	43.0	27	17.0	M16
XSEME01300 200	R2.0	30.0	29.0	30	43.0	27	17.0	M16
XSEME01320 050	R0.5	32.0	31.0	32	45.0	27	17.0	M16
XSEME01320 100	R1.0	32.0	31.0	32	45.0	27	17.0	M16
XSEME01320 150	R1.5	32.0	31.0	32	45.0	27	17.0	M16
XSEME01320 200	R2.0	32.0	31.0	32	45.0	27	17.0	M16

Radius Tolerance(mm)	Mill Dia. Tolerance(mm)
± 0.02	0 ~ - 0.03

◎ : Excellent ○ : Good

ISO Material Description	P											M			K						
	Non-alloy steel					Low alloy steel				High alloyed steel, and tool steel		Stainless steel			Grey cast iron		Nodular cast iron		Malleable cast iron		
VDI 3323	1	2	3	4	5	6	7	8	9	10	11	12	13	14	15	16	17	18	19	20	
HRc		13	25	28	32	10	29	32	38	15	35	15	23	10	10	26	3	25		21	
HB	125	190	250	270	300	180	275	300	350	200	325	200	240	180	180	260	160	250	130	230	
Recommend	○	○	◎	◎	◎	○	◎	◎	◎	○	◎	○	○	○	○	○	○	○	○	○	
ISO Material Description	N										S							H			
	Aluminum-wrought alloy		Aluminum-cast, alloyed			Copper and Copper Alloys (Bronze / Brass)			Non Metallic Materials		Heat Resistant Super Alloys					Titanium Alloys		Hardened steel	Chilled Cast Iron	Hardened Cast Iron	
VDI 3323	21	22	23	24	25	26	27	28	29	30	31	32	33	34	35	36	37	38	39	40	41
HRc											15	30	25	38	34			55	60	42	55
HB	60	100	75	90	130	110	90	100			200	280	250	350	320	400 Rm	1050 Rm	550	630	400	550
Recommend	○	○	○	○	○	○	○	○	○	○	○	○	○	○	○	○	○	○	○	◎	○

CARBIDE MODULAR HEAD, 6 FLUTE 45° HELIX CORNER RADIUS

- Vollhartmetall, 6 Schneiden mit 45° und Eckradius
- CARBURE TÊTE MODULAIRE, 6 DENTS TORIQUE, HÉLICE À 45°
- TESTINA MODULARE IN MD, 6 TAGLIENTI, ELICA 45°, TORICA

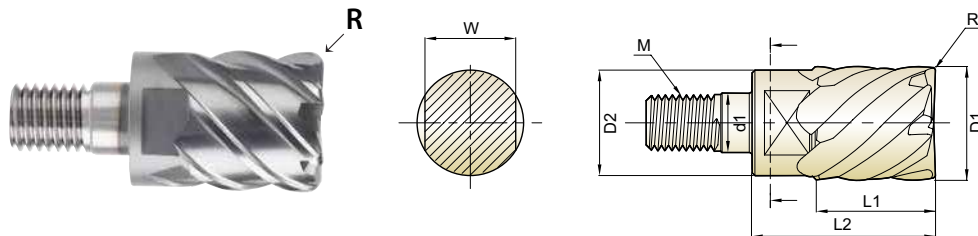

Unit : mm

EDP No.	Corner Radius	Mill Diameter	Neck Diameter	Length of Cut	Length Below Shank	Wrench Width	Coupling Diameter	Thread
Y-COATED	R	D1	D2	L1	L2	W	d1	M
XSEME68100 030	R0.3	10.0	9.2	10	17.5	8	6.5	M6
XSEME68100 050	R0.5	10.0	9.2	10	17.5	8	6.5	M6
XSEME68100 100	R1.0	10.0	9.2	10	17.5	8	6.5	M6
XSEME68120 030	R0.3	12.0	11.2	12	20.5	10	6.5	M6
XSEME68120 050	R0.5	12.0	11.2	12	20.5	10	6.5	M6
XSEME68120 100	R1.0	12.0	11.2	12	20.5	10	6.5	M6
XSEME68160 050	R0.5	16.0	15.0	16	25.5	13	8.5	M8
XSEME68160 100	R1.0	16.0	15.0	16	25.5	13	8.5	M8
XSEME68160 150	R1.5	16.0	15.0	16	25.5	13	8.5	M8
XSEME68160 200	R2.0	16.0	15.0	16	25.5	13	8.5	M8
XSEME68200 050	R0.5	20.0	19.0	20	30.0	17	10.5	M10
XSEME68200 100	R1.0	20.0	19.0	20	30.0	17	10.5	M10
XSEME68200 150	R1.5	20.0	19.0	20	30.0	17	10.5	M10
XSEME68200 200	R2.0	20.0	19.0	20	30.0	17	10.5	M10
XSEME68250 050	R0.5	25.0	24.0	25	37.0	22	12.5	M12
XSEME68250 100	R1.0	25.0	24.0	25	37.0	22	12.5	M12
XSEME68250 150	R1.5	25.0	24.0	25	37.0	22	12.5	M12
XSEME68250 200	R2.0	25.0	24.0	25	37.0	22	12.5	M12
XSEME68300 050	R0.5	30.0	29.0	30	43.0	27	17.0	M16
XSEME68300 100	R1.0	30.0	29.0	30	43.0	27	17.0	M16
XSEME68300 150	R1.5	30.0	29.0	30	43.0	27	17.0	M16
XSEME68300 200	R2.0	30.0	29.0	30	43.0	27	17.0	M16
XSEME68320 050	R0.5	32.0	31.0	32	45.0	27	17.0	M16
XSEME68320 100	R1.0	32.0	31.0	32	45.0	27	17.0	M16
XSEME68320 150	R1.5	32.0	31.0	32	45.0	27	17.0	M16
XSEME68320 200	R2.0	32.0	31.0	32	45.0	27	17.0	M16

Radius Tolerance(mm)	Mill Dia. Tolerance(mm)
± 0.015	0 ~ - 0.03

◎ : Excellent ○ : Good

ISO Material Description	P											M			K						
	Non-alloy steel					Low alloy steel						High alloyed steel, and tool steel			Stainless steel			Grey cast iron		Nodular cast iron	
VDI 3323	1	2	3	4	5	6	7	8	9	10	11	12	13	14	15	16	17	18	19	20	
HRc		13	25	28	32	10	29	32	38	15	35	15	23	10	10	26	3	25	42	21	
HB	125	190	250	270	300	180	275	300	350	200	325	200	240	180	180	260	160	250	130	230	
Recommend	○	○	○	◎	◎	○	◎	◎	◎	◎	◎	○	○	○	○	○	○	○	○	○	
ISO Material Description	N									S						H					
	Aluminum-wrought alloy		Aluminum-cast, alloyed			Copper and Copper Alloys (Bronze / Brass)			Non Metallic Materials		Heat Resistant Super Alloys						Titanium Alloys		Hardened steel	Chilled Cast Iron	Hardened Cast Iron
VDI 3323	21	22	23	24	25	26	27	28	29	30	31	32	33	34	35	36	37	38	39	40	41
HRc											15	30	25	38	34			55	60	42	55
HB	60	100	75	90	130	110	90	100			200	280	250	350	320	400 Rm	1050 Rm	550	630	400	550
Recommend											○	○	○	○	○	○	○	○	○	◎	○

CARBIDE MODULAR HEAD, 4 FLUTE MULTIPLE HELIX

- Vollhartmetall, 4 Schneiden mit M-Helix
- CARBURE TÊTE MODULAIRE, 4 DENTS HÉLICE MULTIPLE
- TESTINA MODULARE IN MD, 4 TAGLIENTI, ELICA VARIABILE

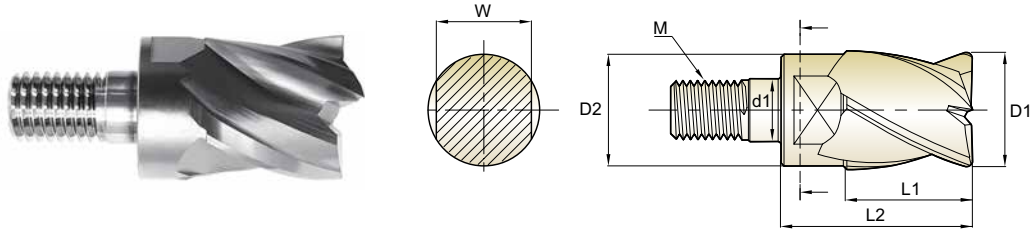

Unit : mm

EDP No.	Mill Diameter	Neck Diameter	Length of Cut	Length Below Shank	Wrench Width	Coupling Diameter	Thread
Y-COATED	D1	D2	L1	L2	W	d1	M
XSEME36100	10.0	9.2	10	17.5	8	6.5	M6
XSEME36120	12.0	11.2	12	20.5	10	6.5	M6
XSEME36160	16.0	15.0	16	25.5	13	8.5	M8
XSEME36200	20.0	19.0	20	30.0	17	10.5	M10
XSEME36250	25.0	24.0	25	37.0	22	12.5	M12
XSEME36300	30.0	29.0	30	43.0	27	17.0	M16
XSEME36320	32.0	31.0	32	45.0	27	17.0	M16

Mill Dia. Tolerance(mm)
0 ~ - 0.03

◎ : Excellent ○ : Good

ISO Material Description	P											M				K						
	Non-alloy steel					Low alloy steel						High alloyed steel, and tool steel				Stainless steel		Grey cast iron		Nodular cast iron		Malleable cast iron
VDI 3323	1	2	3	4	5	6	7	8	9	10	11	12	13	14	15	16	17	18	19	20		
HRc	13	19	25	28	32	10	29	32	38	15	35	15	23	10	10	26	3	25	21	21		
HB	125	190	250	270	300	180	275	300	350	200	325	200	240	180	180	260	160	250	130	230		
Recommend	○	○	◎	◎	◎	○	◎	◎	◎	○	◎	○	○	○	○	○	○	○	○	○		
ISO Material Description	N										S							H				
	Aluminum-wrought alloy		Aluminum-cast, alloyed			Copper and Copper Alloys (Bronze / Brass)			Non Metallic Materials		Heat Resistant Super Alloys					Titanium Alloys		Hardened steel	Chilled Cast Iron	Hardened Cast Iron		
VDI 3323	21	22	23	24	25	26	27	28	29	30	31	32	33	34	35	36	37	38	39	40	41	
HRc											15	30	25	38	34			55	60	42	55	
HB	60	100	75	90	130	110	90	100			200	280	250	350	320	400 Rm	1050 Rm	550	630	400	550	
Recommend	○	○	○	○	○	○	○	○	○	○	○	○	○	○	○	○	○	○	○	◎	○	

CARBIDE MODULAR HEAD, 6 FLUTE 45° HELIX

-  Vollhartmetall, 6 Schneiden mit 45°
-  CARBURE TÊTE MODULAIRE, 6 DENTS HÉLICE À 45°
-  TESTINA MODULARE IN MD, 6 TAGLIENTI, ELICA 45°

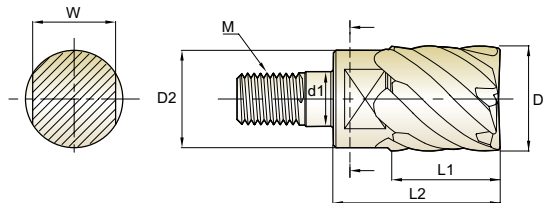

Unit : mm

EDP No.	Mill Diameter	Neck Diameter	Length of Cut	Length Below Shank	Wrench Width	Coupling Diameter	Thread
Y-COATED	D1	D2	L1	L2	W	d1	M
XSEME75100	10.0	9.2	10	17.5	8	6.5	M6
XSEME75120	12.0	11.2	12	20.5	10	6.5	M6
XSEME75160	16.0	15.0	16	25.5	13	8.5	M8
XSEME75200	20.0	19.0	20	30.0	17	10.5	M10
XSEME75250	25.0	24.0	25	37.0	22	12.5	M12
XSEME75300	30.0	29.0	30	43.0	27	17.0	M16
XSEME75320	32.0	31.0	32	45.0	27	17.0	M16

Mill Dia. Tolerance(mm)
0 ~ - 0.03

◎ : Excellent ○ : Good

ISO Material Description	P										M			K							
	Non-alloy steel					Low alloy steel					High alloyed steel, and tool steel			Stainless steel			Grey cast iron		Nodular cast iron		Malleable cast iron
VDI 3323	1	2	3	4	5	6	7	8	9	10	11	12	13	14	15	16	17	18	19	20	
HRc	13	25	28	32	10	29	32	38	15	35	15	23	10	10	26	3	25	130	21		
HB	125	190	250	270	300	180	275	300	350	200	325	200	240	180	180	260	160	250	130	230	
Recommend	○	○	◎	◎	◎	○	◎	◎	◎	○	◎				○	○	○	○	○	○	
ISO Material Description	N									S						H					
	Aluminum-wrought alloy		Aluminum-cast, alloyed			Copper and Copper Alloys (Bronze / Brass)			Non Metallic Materials		Heat Resistant Super Alloys						Titanium Alloys		Hardened steel	Chilled Cast Iron	Hardened Cast Iron
VDI 3323	21	22	23	24	25	26	27	28	29	30	31	32	33	34	35	36	37	38	39	40	41
HRc	60	100	75	90	130	110	90	100			15	30	25	38	34	55	60	55	60	42	55
HB	60	100	75	90	130	110	90	100			200	280	250	350	320	400 Rm	1050 Rm	550	630	400	550
Recommend																		○	○	◎	○

CARBIDE HOLDER - STRAIGHT NECK TYPE

- Vollhartmetallschaft - zylindrisch
- PORTE-OUTIL CARBURE - Entrée Droite
- STELO IN MD, SCARICO CILINDRICO

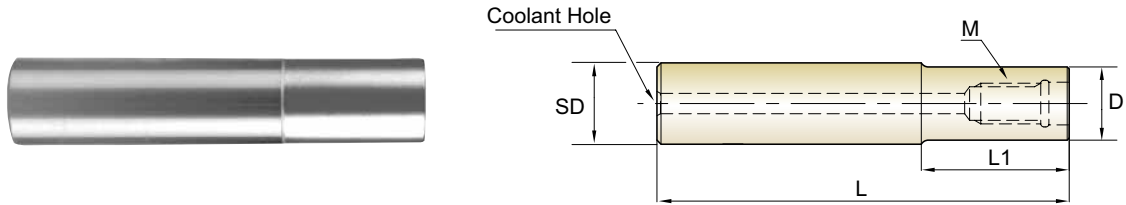



Unit : mm

EDP No.	Mill Diameter	Shank Diameter	Overall Length	Neck Length	Neck Diameter	Thread Size	Wrench No.	Coolant Hole
		SD	L	L1	D	M		
ZMC1001100	10.0	10	70	20	9.5	M6	SPIS0810	2
ZMC1002100	10.0	10	100	40	9.5	M6	SPIS0810	2
ZMC1003100	10.0	10	130	70	9.5	M6	SPIS0810	2
ZMC1201120	12.0	12	80	20	11.5	M6	SPIS0810	2
ZMC1202120	12.0	12	100	40	11.5	M6	SPIS0810	2
ZMC1203120	12.0	12	130	70	11.5	M6	SPIS0810	2
ZMC1601160	16.0	16	100	40	15.5	M8	SPIS1300	3
ZMC1602160	16.0	16	150	80	15.5	M8	SPIS1300	3
ZMC1603160	16.0	16	200	120	15.5	M8	SPIS1300	3
ZMC2001200	20.0	20	100	40	19.5	M10	SPIS1700	4
ZMC2002200	20.0	20	150	80	19.5	M10	SPIS1700	4
ZMC2003200	20.0	20	200	120	19.5	M10	SPIS1700	4
ZMC2004200	20.0	20	250	160	19.5	M10	SPIS1700	4
ZMC2501250	25.0	25	150	70	24.3	M12	SPIS2200	5
ZMC2502250	25.0	25	200	100	24.3	M12	SPIS2200	5
ZMC2503250	25.0	25	250	150	24.3	M12	SPIS2200	5
ZMC2504250	25.0	25	300	200	24.3	M12	SPIS2200	5
ZMC3001320	30.0 / 32.0	32	150	70	29.0	M16	SPIS2700	6
ZMC3002320	30.0 / 32.0	32	200	120	29.0	M16	SPIS2700	6
ZMC3003320	30.0 / 32.0	32	250	150	29.0	M16	SPIS2700	6
ZMC3004320	30.0 / 32.0	32	300	200	29.0	M16	SPIS2700	6
ZMC3005320	30.0 / 32.0	32	350	250	29.0	M16	SPIS2700	6

- ▶The wrench (1pc) for the relevant item is included.
If more is needed, available for sale.
- ▶Please refer to the wrench table on the next page.

STEEL HOLDER - STRAIGHT NECK TYPE

-  **Stahlschaft - zylindrisch**
-  **PORTE-OUTIL ACIER - Entrée Droite**
-  **STELO IN ACCIAIO, SCARICO CILINDRICO**

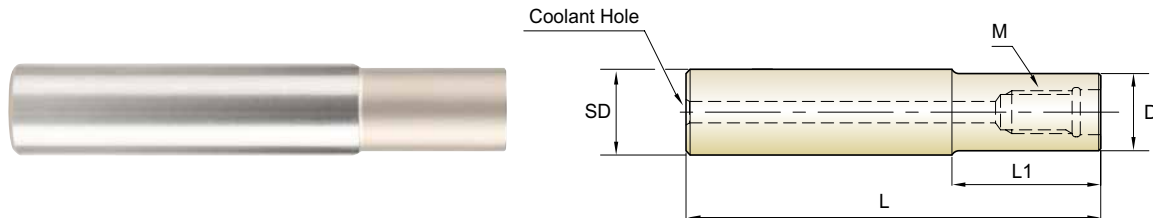





EDP No.	Mill Diameter	Shank Diameter	Overall Length	Neck Length	Neck Diameter	Thread Size	Wrench No.	Coolant Hole
		SD	L	L1	D	M		
ZMS1001100	10.0	10	70	20	9	M6	SPIS0810	3
ZMS1201120	12.0	12	90	30	11	M6	SPIS0810	3
ZMS1601160	16.0	16	100	30	15	M8	SPIS1300	4
ZMS2001200	20.0	20	100	30	19	M10	SPIS1700	5
ZMS2501250	25.0	25	115	40	24	M12	SPIS2200	5
ZMS3001320	30.0 / 32.0	32	125	40	29	M16	SPIS2700	6

Unit : mm

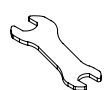
► The wrench (1pc) for the relevant item is included.
If more is needed, available for sale.

Wrench

Model	Wrench No.	Wrench Width	Mill Diameter	Clamping Torque [N·m]
	SPIS0810	8	10.0	6.5
		10	12.0	6.5
	SPIS1300	13	16.0	10
	SPIS1700	17	20.0	12
	SPIS2200	22	25.0	15
	SPIS2700	27	30.0 32.0	20

 CBN
END MILLS

 i-Xmill
END MILLS

**i-SMART
MODULAR
END MILLS**

 X5070
END MILLS

 4G MILL
END MILLS

 X-POWER
PRO
END MILLS

 TiAlN-
POWER
END MILLS

 JET-POWER
END MILLS

 V7 PLUS
END MILLS

 ALU-POWER
HPC
END MILLS

 ALU-
POWER
END MILLS

 D-POWER
GRAPHITE
END MILLS

 D-POWER
CFRP
END MILLS

ROUTERS

 CRX S
END MILLS

 K-2
END MILLS

 ONLY ONE
COATED PM60
END MILLS



 TANK-
POWER
END MILLS

 GENERAL
HSS
END MILLS

 MILLING
CUTTERS

 TECHNICAL
DATA

STEEL HOLDER - TAPER NECK TYPE

-  **Stahlschaft - konisch**
-  **PORTE-OUTIL ACIER - Entrée Conique**
-  **STELO IN ACCIAIO, SCARICO CONICO**

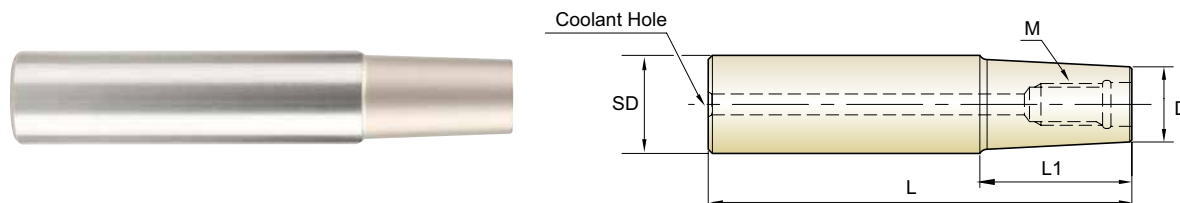





Unit : mm

EDP No.	Mill Diameter	Shank Diameter	Overall Length	Neck Length	Neck Diameter	Thread Size	Wrench No.	Coolant Hole
		SD	L	L ₁	D	M		
ZMT1001120	10.0	12	100	50	9	M6	SPIS0810	3
ZMT1201160	12.0	16	130	70	11	M6	SPIS0810	3
ZMT1601200	16.0	20	150	90	15	M8	SPIS1300	4
ZMT2001250	20.0	25	170	100	19	M10	SPIS1700	5
ZMT2501320	25.0	32	200	110	24	M12	SPIS2200	5
ZMT3001320	30.0 / 32.0	32	200	110	29	M16	SPIS2700	6

- The wrench(1pc) for the relevant item is included.
If more is needed, available for sale.

Wrench

Model	Wrench No.	Wrench Width	Mill Diameter	Clamping Torque [N·m]
	SPIS0810	8	10.0	6.5
		10	12.0	6.5
	SPIS1300	13	16.0	10
	SPIS1700	17	20.0	12
	SPIS2200	22	25.0	15
	SPIS2700	27	30.0 32.0	20

Instruction Manual
BEDIENUNGSAMLEITUNG

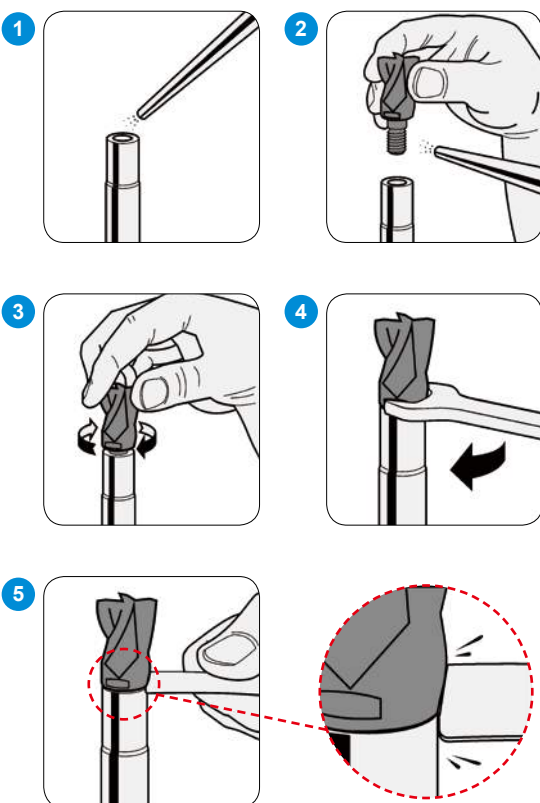

Step 1, 2 : Clean

Please be sure to remove dirt and debris on all adjoining surfaces before assembling. (air preferred)

Schritt 1, 2: Reinigen

Achten Sie darauf, Schmutz und Verunreinigungen an allen angrenzenden Flächen vor dem Zusammenbau zu entfernen. (bevorzugt durch Luft)

Step 3, 4 : Assembly

Mount the modular head onto the shank by hand until it fits then use the supplied wrench to tighten.

Schritt 3, 4: Zusammenbau

Montieren Sie den modularen Kopf von Hand auf den Schaft, bis er passt. Benutzen Sie dann den mitgelieferten Schraubenschlüssel.

Step 5 : Final Check

Re-check that there is no gap.

Schritt 5, 6: Endkontrolle

Überprüfen Sie, dass es kein mehr Spalt sichtbar ist.

Notice

Please tighten the screw with designated torque, too much torque will damage the screw.

Achtung

Ziehen Sie die Schraube mit dem vorgesehenen Drehmoment an, zu viel Drehmoment wird die Schraube beschädigen.

Mill Diameter (D)	Clamping Torque [N·m]
10.0	6.5
12.0	6.5
16.0	10.0
20.0	12.0
25.0	15.0
30.0	20.0
32.0	20.0

XSEMD98 SERIES **2 FLUTE BALL NOSE**

Vc = m/min.
fz = mm/tooth
RPM = rev./min.
FEED = mm/min.

ISO	VDI 3323	Material Description	Ae	Ap	Parameter	Diameter (Ø)						
						10	12	16	20	25	30	32
P	1-8	Non-alloy steel	0.08D	0.03D	Vc	175	170	168	168	167	167	167
					fz	0.199	0.212	0.238	0.264	0.270	0.299	0.300
					RPM	5580	4510	3340	2670	2130	1770	1660
	9	Low alloy steel	0.08D	0.03D	Vc	168	165	162	162	162	162	162
					fz	0.174	0.188	0.206	0.227	0.231	0.250	0.250
					RPM	5340	4380	3220	2580	2060	1720	1610
	10-11.1	High alloyed steel, and tool steel	0.08D	0.03D	Vc	175	170	168	168	167	167	167
					fz	0.199	0.212	0.238	0.264	0.270	0.299	0.300
					RPM	5580	4510	3340	2670	2130	1770	1660
	11.2	High alloyed steel, and tool steel	0.08D	0.03D	Vc	168	165	162	162	162	162	162
					fz	0.174	0.188	0.206	0.227	0.231	0.250	0.250
					RPM	5340	4380	3220	2580	2060	1720	1610
K	15-20	Grey cast iron Nodular cast iron Malleable cast iron	0.08D	0.03D	Vc	175	170	168	168	167	167	167
					fz	0.199	0.212	0.238	0.264	0.270	0.299	0.300
					RPM	5580	4510	3340	2670	2130	1770	1660
H	38.1 - 38.2	Hardened steel	0.08D	0.03D	Vc	141	138	136	136	136	136	136
					fz	0.160	0.170	0.189	0.208	0.211	0.229	0.230
					RPM	4500	3660	2700	2160	1730	1440	1350
40	Chilled Cast Iron	0.08D	0.03D	Vc	168	165	162	162	162	162	162	
				fz	0.174	0.188	0.206	0.227	0.231	0.250	0.250	
				RPM	5340	4380	3220	2580	2060	1720	1610	
41	Hardened Cast Iron	0.08D	0.03D	Vc	141	138	136	136	136	136	136	
				fz	0.160	0.170	0.189	0.208	0.211	0.229	0.230	
				RPM	4500	3660	2700	2160	1730	1440	1350	

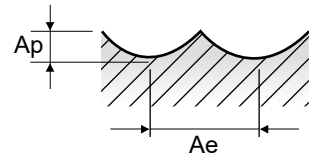

XSEME59 SERIES **3 FLUTE BALL NOSE**

ISO	VDI 3323	Material Description	Ae	Ap	Parameter	Diameter (Ø)						
						10	12	16	20	25	30	32
P	1-8	Non-alloy steel	0.05D	0.02D	Vc	307	307	307	307	307	307	307
					fz	0.201	0.225	0.234	0.238	0.248	0.259	0.268
					RPM	9770	8150	6100	4880	3910	3260	3050
	9	Low alloy steel	0.05D	0.02D	Vc	5890	5490	4280	3490	2910	2530	2450
					fz	257	257	257	257	257	257	257
					RPM	0.168	0.187	0.199	0.209	0.219	0.230	0.234
	10-11.1	High alloyed steel, and tool steel	0.05D	0.02D	Vc	8190	6830	5110	4090	3270	2730	2560
					fz	4130	3830	3050	2560	2150	1880	1800
					RPM	307	307	307	307	307	307	307
	11.2	High alloyed steel, and tool steel	0.05D	0.02D	Vc	0.201	0.225	0.234	0.238	0.248	0.259	0.268
					fz	9770	8150	6100	4880	3910	3260	3050
					RPM	5890	5490	4280	3490	2910	2530	2450
K	15-20	Grey cast iron Nodular cast iron Malleable cast iron	0.05D	0.02D	Vc	257	257	257	257	257	257	257
					fz	0.168	0.187	0.199	0.209	0.219	0.230	0.234
					RPM	8190	6830	5110	4090	3270	2730	2560
H	38.1 - 38.2	Hardened steel	0.05D	0.02D	Vc	4130	3830	3050	2560	2150	1880	1800
					fz	307	307	307	307	307	307	307
					RPM	0.201	0.225	0.234	0.238	0.248	0.259	0.268
40	Chilled Cast Iron	0.05D	0.02D	Vc	0.201	0.225	0.234	0.238	0.248	0.259	0.268	
				fz	9770	8150	6100	4880	3910	3260	3050	
				RPM	5890	5490	4280	3490	2910	2530	2450	
41	Hardened Cast Iron	0.05D	0.02D	Vc	208	208	208	208	208	208	208	
				fz	0.156	0.173	0.180	0.190	0.200	0.210	0.221	
				RPM	6620	5520	4140	3310	2650	2210	2070	

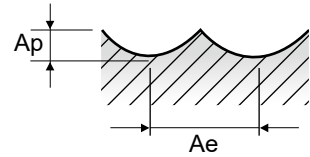

Vc = m/min.
fz = mm/tooth
RPM = rev./min.
FEED = mm/min.

XSEME60 SERIES **4 FLUTE BALL NOSE**

ISO	VDI 3323	Material Description	Ae	Ap	Parameter	Diameter (Ø)						
						10	12	16	20	25	30	32
P	1-8	Non-alloy steel	0.05D	0.02D	Vc	341	341	341	341	341	341	341
					fz	0.148	0.165	0.175	0.179	0.186	0.194	0.201
	9	Low alloy steel	0.05D	0.02D	RPM	10850	9050	6780	5430	4340	3620	3390
					FEED	6430	5960	4750	3880	3230	2810	2720
	10-11.1	High alloyed steel, and tool steel	0.05D	0.02D	Vc	286	286	286	286	286	286	286
					fz	0.126	0.140	0.149	0.156	0.164	0.172	0.176
	11.2	High alloyed steel, and tool steel	0.05D	0.02D	RPM	9100	7500	5680	4550	3640	3030	2840
					FEED	4590	4260	3390	2840	2390	2090	2000
K	15-20	Grey cast iron Nodular cast iron Malleable cast iron	0.05D	0.02D	Vc	341	341	341	341	341	341	341
					fz	0.148	0.165	0.175	0.179	0.186	0.194	0.201
					RPM	10850	9050	6780	5430	4340	3620	3390
H	38.1 - 38.2	Hardened steel	0.05D	0.02D	FEED	6430	5960	4750	3880	3230	2810	2720
					Vc	231	231	231	231	231	231	231
					fz	0.117	0.130	0.135	0.143	0.150	0.157	0.165
	40	Chilled Cast Iron	0.05D	0.02D	RPM	7350	6130	4600	3680	2940	2450	2300
					FEED	3450	3190	2490	2100	1760	1540	1520
					Vc	286	286	286	286	286	286	286
	41	Hardened Cast Iron	0.05D	0.02D	fz	0.126	0.140	0.149	0.156	0.164	0.172	0.176
					RPM	9100	7500	5680	4550	3640	3030	2840
					FEED	4590	4260	3390	2840	2390	2090	2000
	41	Hardened Cast Iron	0.05D	0.02D	Vc	231	231	231	231	231	231	231
					fz	0.117	0.130	0.135	0.143	0.150	0.157	0.165
					RPM	7350	6130	4600	3680	2940	2450	2300
41	Hardened Cast Iron	0.05D	0.02D	FEED	3450	3190	2490	2100	1760	1540	1520	

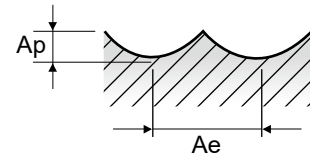

XSEME01 SERIES **4 FLUTE CORNER RADIUS - SIDE CUTTING**

ISO	VDI 3323	Material Description	Ae	Ap	Parameter	Diameter (Ø)							
						10	12	16	20	25	30	32	
P	1-8	Non-alloy steel	0.05D	0.8D	Vc	156	156	156	156	156	156	156	
					fz	0.023	0.023	0.023	0.023	0.023	0.023	0.023	
	9	Low alloy steel	0.05D	0.8D	RPM	4970	4140	3100	2480	1990	1650	1550	
					FEED	455	380	280	230	180	150	140	
	10-11.1	High alloyed steel, and tool steel	0.05D	0.8D	Vc	105	105	105	105	105	105	105	
					fz	0.027	0.027	0.027	0.027	0.027	0.027	0.026	
	11.2	High alloyed steel, and tool steel	0.05D	0.8D	RPM	3340	2780	2090	1670	1340	1110	1040	
					FEED	360	300	225	180	145	120	110	
	K	15-20	Grey cast iron Nodular cast iron Malleable cast iron	0.02D	0.8D	Vc	156	156	156	156	156	156	156
						fz	0.023	0.023	0.023	0.023	0.023	0.023	0.023
						RPM	4960	4140	3100	2480	1990	1650	1550
	H	38.1 - 38.2	Hardened steel	0.02D	0.8D	FEED	460	380	280	230	180	150	140
Vc						63	63	63	63	63	63	63	
fz						0.021	0.021	0.022	0.023	0.023	0.024	0.024	
40		Chilled Cast Iron	0.05D	0.8D	RPM	2020	1680	1250	1000	800	670	630	
					FEED	170	140	110	90	75	65	60	
					Vc	105	105	105	105	105	105	105	
41		Hardened Cast Iron	0.02D	0.8D	fz	0.027	0.027	0.027	0.027	0.027	0.027	0.026	
					RPM	3340	2780	2090	1670	1340	1110	1040	
					FEED	360	300	225	180	145	120	110	
41		Hardened Cast Iron	0.02D	0.8D	Vc	63	63	63	63	63	63	63	
					fz	0.021	0.021	0.022	0.023	0.023	0.024	0.024	
					RPM	2020	1680	1250	1000	800	670	630	
41	Hardened Cast Iron	0.02D	0.8D	FEED	170	140	110	90	75	65	60		

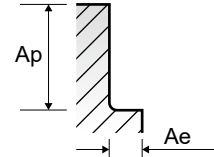

XSEME68 SERIES **6 FLUTE CORNER RADIUS - SIDE CUTTING**

Vc = m/min.
fz = mm/tooth
RPM = rev./min.
FEED = mm/min.

ISO	VDI 3323	Material Description	Ae	Ap	Parameter	Diameter (Ø)						
						10	12	16	20	25	30	32
P	1-8	Non-alloy steel	0.05D	1.0D	Vc	302	302	302	302	302	302	302
					fz	0.051	0.058	0.067	0.070	0.070	0.075	0.075
					RPM	9600	8010	6000	4800	3850	3200	3000
	9	Low alloy steel	0.05D	1.0D	FEED	2940	2790	2400	2010	1615	1440	1350
					Vc	294	294	294	294	294	294	294
					fz	0.025	0.025	0.025	0.025	0.027	0.029	0.030
	10-11.1	High alloyed steel, and tool steel	0.05D	1.0D	RPM	9360	7800	5850	4680	3740	3120	2920
					FEED	1400	1170	880	690	600	540	525
					Vc	302	302	302	302	302	302	302
	11.2	High alloyed steel, and tool steel	0.05D	1.0D	fz	0.051	0.058	0.067	0.070	0.070	0.075	0.075
					RPM	9600	8010	6000	4800	3850	3200	3000
					FEED	2940	2700	2400	2010	1615	1440	1350
K	15-20	Grey cast iron Nodular cast iron Malleable cast iron	0.05D	1.0D	Vc	294	294	294	294	294	294	294
					fz	0.025	0.025	0.025	0.025	0.027	0.029	0.030
					RPM	9360	7800	5850	4680	3740	3120	2920
H	38.1 - 38.2	Hardened steel	0.02D	1.0D	FEED	1400	1170	880	690	600	540	525
					Vc	181	181	181	181	181	181	181
					fz	0.006	0.006	0.006	0.006	0.007	0.007	0.007
40	Chilled Cast Iron	0.05D	1.0D	RPM	5760	4800	3600	2880	2305	1920	1800	
				FEED	210	180	130	110	90	85	80	
				Vc	294	294	294	294	294	294	294	
41	Hardened Cast Iron	0.02D	1.0D	fz	0.025	0.025	0.025	0.025	0.027	0.029	0.030	
				RPM	9360	7800	5850	4680	3740	3120	2920	
				FEED	1400	1170	880	690	600	540	525	
H	41	Hardened Cast Iron	0.02D	1.0D	Vc	181	181	181	181	181	181	181
					fz	0.006	0.006	0.006	0.006	0.007	0.007	0.007
					RPM	5760	4800	3600	2880	2305	1920	1800
H	41	Hardened Cast Iron	0.02D	1.0D	FEED	210	180	130	110	90	85	80

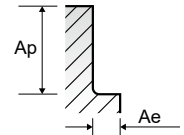

XSEME36 SERIES **4 FLUTE - SIDE CUTTING**

ISO	VDI 3323	Material Description	Ae	Ap	Parameter	Diameter (Ø)						
						10	12	16	20	25	30	32
P	1-8	Non-alloy steel	0.05D	0.6D	Vc	128	129	130	132	134	134	134
					fz	0.040	0.040	0.040	0.040	0.040	0.040	0.040
					RPM	4080	3430	2590	2100	1700	1420	1330
	9	Low alloy steel	0.05D	0.6D	FEED	650	545	415	335	270	230	215
					Vc	79	79	80	82	82	82	82
					fz	0.030	0.030	0.030	0.030	0.031	0.032	0.032
	10-11.1	High alloyed steel, and tool steel	0.05D	0.6D	RPM	2500	2100	1590	1300	1050	870	820
					FEED	300	250	190	155	130	110	105
					Vc	128	129	130	132	134	134	134
	11.2	High alloyed steel, and tool steel	0.05D	0.6D	fz	0.040	0.040	0.040	0.040	0.040	0.040	0.040
					RPM	4080	3430	2590	2100	1700	1420	1330
					FEED	650	545	415	335	270	230	215
M	12-14	Stainless steel	0.05D	0.6D	Vc	79	79	80	82	82	82	82
					fz	0.030	0.030	0.030	0.030	0.031	0.032	0.032
					RPM	2500	2100	1590	1300	1050	870	820
K	15-20	Grey cast iron Nodular cast iron Malleable cast iron	0.05D	0.6D	FEED	300	250	190	155	130	110	105
					Vc	66	66	66	66	67	67	67
					fz	0.035	0.035	0.035	0.035	0.035	0.035	0.035
H	38.1 - 38.2	Hardened steel	0.05D	0.6D	RPM	2100	1750	1310	1050	850	710	670
					FEED	300	245	180	150	120	100	95
					Vc	128	129	130	132	134	134	134
40	Chilled Cast Iron	0.05D	0.6D	fz	0.039	0.040	0.040	0.040	0.040	0.040	0.040	
				RPM	4080	3430	2590	2100	1700	1420	1330	
				FEED	640	545	415	335	270	230	215	
41	Hardened Cast Iron	0.05D	0.6D	Vc	53	53	53	53	53	53	53	
				fz	0.013	0.013	0.013	0.012	0.011	0.011	0.011	
				RPM	1700	1400	1050	850	680	560	530	
H	41	Hardened Cast Iron	0.05D	0.6D	FEED	90	70	55	40	30	25	25
					Vc	79	79	80	82	82	82	82
					fz	0.030	0.030	0.030	0.030	0.031	0.032	0.032
H	41	Hardened Cast Iron	0.05D	0.6D	RPM	2500	2100	1590	1300	1050	870	820
					FEED	300	250	190	155	130	110	105
					Vc	53	53	53	53	53	53	53
H	41	Hardened Cast Iron	0.05D	0.6D	fz	0.013	0.013	0.013	0.012	0.011	0.011	0.011
					RPM	1700	1400	1050	850	680	560	530
					FEED	90	70	55	40	30	25	25

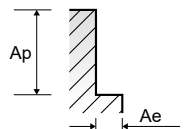

XSEME75 SERIES **6 FLUTE - SIDE CUTTING**

Vc = m/min.
fz = mm/tooth
RPM = rev./min.
FEED = mm/min.

NORMAL SPEED

ISO	VDI 3323	Material Description	Ae	Ap	Parameter	Diameter (Ø)						
						10	12	16	20	25	30	32
P	1-8	Non-alloy steel	0.1D	0.8D	Vc	111	111	111	111	111	111	111
					fz	0.099	0.099	0.100	0.100	0.100	0.100	0.100
					RPM	3530	2945	2205	1765	1410	1180	1100
	9	Low alloy steel	0.05D	0.8D	FEED	2100	1750	1325	1060	845	710	660
					Vc	77	77	77	77	77	77	77
					fz	0.094	0.094	0.094	0.094	0.094	0.094	0.094
	10-11.1	High alloyed steel, and tool steel	0.1D	0.8D	RPM	2450	2040	1530	1220	980	815	765
					FEED	1380	1150	860	690	555	460	430
					Vc	111	111	111	111	111	111	111
	11.2	High alloyed steel, and tool steel	0.05D	0.8D	fz	0.099	0.099	0.100	0.100	0.100	0.100	0.100
					RPM	3530	2945	2205	1765	1410	1180	1100
					FEED	2100	1750	1325	1060	845	710	660
K	15-20	Grey cast iron Nodular cast iron Malleable cast iron	0.1D	0.8D	Vc	111	111	111	111	111	111	111
					fz	0.099	0.099	0.100	0.100	0.100	0.100	0.100
					RPM	3530	2940	2205	1765	1410	1180	1100
	38.1 - 38.2	Hardened steel	0.05D	0.6D	FEED	2100	1765	1325	1060	845	710	660
					Vc	33	33	33	33	33	33	33
					fz	0.033	0.034	0.034	0.035	0.035	0.036	0.036
	40	Chilled Cast Iron	0.05D	0.8D	RPM	1050	880	655	525	420	350	330
					FEED	210	180	130	110	85	75	70
					Vc	77	77	77	77	77	77	77
	41	Hardened Cast Iron	0.05D	0.6D	fz	0.094	0.094	0.094	0.094	0.094	0.094	0.094
					RPM	2450	2040	1530	1220	980	815	765
					FEED	1380	1150	860	690	555	460	430
41	Hardened Cast Iron	0.05D	0.6D	Vc	33	33	33	33	33	33	33	
				fz	0.033	0.034	0.034	0.035	0.035	0.036	0.036	
				RPM	1050	880	655	525	420	350	330	
41	Hardened Cast Iron	0.05D	0.6D	FEED	210	180	130	110	85	75	70	

HIGH SPEED

ISO	VDI 3323	Material Description	Ae	Ap	Parameter	Diameter (Ø)						
						10	12	16	20	25	30	32
P	11.2	High alloyed steel, and tool steel	0.05D	0.6D	Vc	332	332	332	332	332	332	332
					fz	0.095	0.095	0.095	0.095	0.095	0.095	0.095
					RPM	10570	8810	6600	5290	4230	3520	3300
					FEED	6020	5020	3765	3050	2400	2000	1890
H	38.1 - 38.2	Hardened steel	0.05D	0.4D	Vc	166	166	166	166	166	166	166
					fz	0.096	0.095	0.095	0.095	0.095	0.095	0.095
					RPM	5290	4410	3300	2645	2114	1761	1651
	40	Chilled Cast Iron	0.05D	0.6D	FEED	3050	2520	1880	1470	1200	1000	940
					Vc	332	332	332	332	332	332	332
					fz	0.095	0.095	0.095	0.095	0.095	0.095	0.095
	41	Hardened Cast Iron	0.05D	0.4D	RPM	10570	8810	6600	5290	4230	3520	3300
					FEED	6020	5020	3765	3050	2400	2000	1890
					Vc	166	166	166	166	166	166	166
	41	Hardened Cast Iron	0.05D	0.4D	fz	0.096	0.095	0.095	0.095	0.095	0.095	0.095
					RPM	5290	4410	3300	2645	2114	1761	1651
					FEED	3050	2520	1880	1470	1200	1000	940

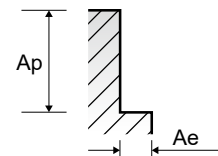



Global Cutting Tool Leader **YG-1**



MILLING



Leading Through Innovation



SOLID CARBIDE

X5070 END MILLS

X5070 NANO-VHM - FRÄSER

- For High Hardened Steels (HRc45 to HRc70)
High Speed Machining and Dry Cutting
- Für hochgehärtete Stähle (HRc45 bis HRc70)
Hochgeschwindigkeitsbearbeitung und Trockenbearbeitung

SELECTION GUIDE

HSS



SERIES	G8B59	G8B54	G8A46	G8A54
FLUTE	4	4	2	2
HELIX ANGLE	0°	0°	30°	30°
CUTTING EDGE SHAPE	CORNER RADIUS	CORNER RADIUS	BALL NOSE	BALL NOSE
SIZE MIN	D2.0	D2.0	R0.05	R0.25
SIZE MAX	D12.0	D16.0	R2.0	R1.0
PAGE	105	106	107	111

CBN END MILLS

i-Xmill END MILLS

i-SMART MODULAR END MILLS

X5070 END MILLS

4G MILL END MILLS

X-POWER PRO END MILLS

TitaNox-POWER END MILLS

JET-POWER END MILLS

V7 PLUS END MILLS

ALU-POWER HPC END MILLS

ALU-POWER END MILLS

D-POWER GRAPHITE END MILLS

D-POWER CFRP END MILLS

ROUTERS

CRX S END MILLS

K-2 END MILLS

ONLY ONE COATED PM60 END MILLS

TANK-POWER END MILLS

GENERAL HSS END MILLS

MILLING CUTTERS

TECHNICAL DATA

SOLID CARBIDE
X5070
END MILLS

High Hardened Steels HRc45 to HRc70,
High Speed Machining, Dry Cutting



Please visit
globalyg1.com/mat
for material search

◎ : Excellent ○ : Good

Recommended cutting conditions : P 139

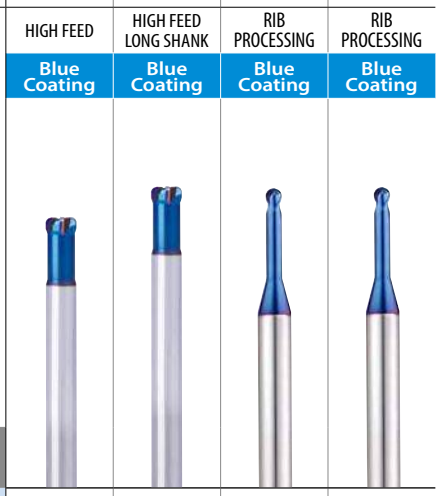

ISO	VDI 3323	Material Description	Composition / Structure / Heat Treatment	HB	HRc				
P	1	Non-alloy steel	About 0.15% C Annealed	125					
	2		About 0.45% C Annealed	190	13				
	3		About 0.45% C Quenched & Tempered	250	25				
	4		About 0.75% C Annealed	270	28				
	5		About 0.75% C Quenched & Tempered	300	32	○	○	○	○
	6	Low alloy steel	Annealed	180	10				
	7		Quenched & Tempered	275	29				
	8		Quenched & Tempered	300	32	○	○	○	○
	9		Quenched & Tempered	350	38	○	○	○	○
	10		High alloyed steel, and tool steel	Annealed	200	15			
	11	Quenched & Tempered		325	35	○	○	○	○
M	12	Stainless steel	Ferritic / Martensitic Annealed	200	15				
	13		Martensitic Quenched & Tempered	240	23				
	14		Austenitic	180	10				
K	15	Grey cast iron	Pearlitic / ferritic	180	10				
	16		Pearlitic (Martensitic)	260	26				
	17	Nodular cast iron	Ferritic	160	3				
	18		Pearlitic	250	25				
	19	Malleable cast iron	Ferritic	130					
20	Pearlitic		230	21					
N	21	Aluminum-wrought alloy	Not Curable	60					
	22		Curable Hardened	100					
	23	Aluminum-cast, alloyed	≤ 12% Si, Not Curable	75					
	24		≤ 12% Si, Curable Hardened	90					
	25		> 12% Si, Not Curable	130					
	26	Copper and Copper Alloys (Bronze / Brass)	Cutting Alloys, PB>1%	110					
	27		CuZn, CuSnZn (Brass)	90					
	28		CuSn, lead-free copper and electrolytic copper	100					
	29	Non Metallic Materials	Duroplastic, Fiber Reinforced Plastic						
	30		Rubber, Wood, etc.						
S	31	Heat Resistant Super Alloys	Fe Based	Annealed	200	15			
	32			Cured	280	30			
	33		Ni or Co Based	Annealed	250	25			
	34			Cured	350	38			
	35			Cast	320	34			
	36	Titanium Alloys	Pure Titanium	400 Rm					
37	Alpha + Beta Alloys		Hardened	1050 Rm					
H	38	Hardened steel	Hardened	550	55	◎	◎	◎	◎
	39		Hardened	630	60	◎	◎	◎	◎
	40	Chilled Cast Iron	Cast	400	42	○	○	○	○
	41	Hardened Cast Iron	Hardened	550	55	◎	◎	◎	◎

G8A28	G8A38	G8A53	G8A59	G8D62	G8A60	G8A36	G8A52	G8A50	G8A47	G8A37	G8B08	G8A39
2	2	2	3	4	2	2	2	2	4	4	4	6
30°	30°	30°	30°	30°	30°	30°	30°	30°	30°	30°	30°	45°
BALL NOSE	BALL NOSE	BALL NOSE	BALL NOSE	BALL NOSE	CORNER RADIUS	CORNER RADIUS	CORNER RADIUS	CORNER RADIUS	CORNER RADIUS	CORNER RADIUS	CORNER RADIUS	CORNER RADIUS
R0.05	R0.5	R0.2	R1.5	R1.5	D0.5	D0.3	D0.5	D0.3	D3.0	D1.0	D6.0	D6.0
R6.0	R12.5	R1.0	R10.0	R10.0	D12.0	D20.0	D2.0	D2.0	D12.0	D20.0	D12.0	D20.0
112	114	115	116	117	118	123	125	126	127	128	129	130
-	EXTENDED NECK	MINIATURE	Center Match	Center Match	RIB PROCESSING	EXTENDED NECK	RIB PROCESSING	MINIATURE	EXTENDED NECK	EXTENDED NECK	EXTENDED NECK	EXTENDED NECK
Blue Coating	Blue Coating	Blue Coating	Blue Coating	Blue Coating	Blue Coating	Blue Coating	Blue Coating	Blue Coating	Blue Coating	Blue Coating	Blue Coating	Blue Coating

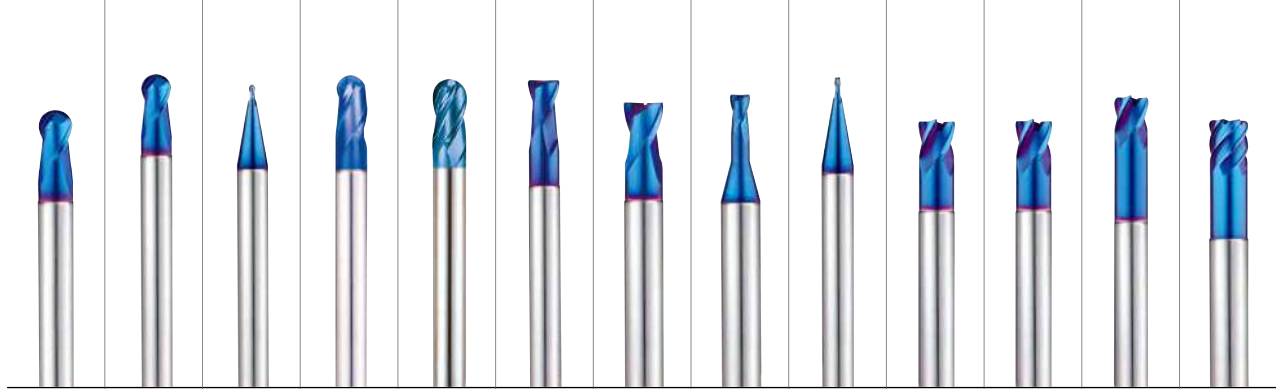

													1
													2
													3
													4
○	○	○	○	○	○	○	○	○	○	○	○	○	5
													6 P
○	○	○	○	○	○	○	○	○	○	○	○	○	7
○	○	○	○	○	○	○	○	○	○	○	○	○	8
○	○	○	○	○	○	○	○	○	○	○	○	○	9
○	○	○	○	○	○	○	○	○	○	○	○	○	10
													11
													12
													13 M
													14
													15
													16
													17 K
													18
													19
													20
													21
													22
													23
													24
													25 N
													26
													27
													28
													29
													30
													31
													32
													33
													34 S
													35
													36
													37
◎	◎	◎	◎	◎	◎	◎	◎	◎	◎	◎	◎	◎	38
◎	◎	◎	◎	◎	◎	◎	◎	◎	◎	◎	◎	◎	39
○	○	○	○	○	○	○	○	○	○	○	○	○	40
◎	◎	◎	◎	◎	◎	◎	◎	◎	◎	◎	◎	◎	41

HSS

CBN END MILLS

i-Xmill END MILLS

i-SMART MODULAR END MILLS

X5070 END MILLS

4G MILL END MILLS

X-POWER PRO END MILLS

TitaNox-POWER END MILLS

JET-POWER END MILLS

V7 PLUS END MILLS

ALU-POWER HPC END MILLS

ALU-POWER END MILLS

D-POWER GRAPHITE END MILLS

D-POWER CFRP END MILLS

ROUTERS

CRX S END MILLS

K-2 END MILLS

ONLY ONE COATED PM60 END MILLS

TANK-POWER END MILLS

GENERAL HSS END MILLS

MILLING CUTTERS

TECHNICAL DATA

SELECTION GUIDE

HSS



SERIES	G8A45	G8A01	G8A02	G8D63	G8D64
FLUTE	2	2	4	6&8	6&8
HELIX ANGLE	30°	30°	30°	45°	45°
CUTTING EDGE SHAPE	SQUARE	SQUARE	SQUARE	SQUARE	SQUARE
SIZE MIN	D0.1	D0.1	D1.0	D6.0	D6.0
SIZE MAX	D4.0	D20.0	D20.0	D25.0	D25.0
PAGE	131	135	136	137	138

CBN END MILLS
i-Xmill END MILLS

i-SMART MODULAR END MILLS

X5070 END MILLS

4G MILL END MILLS

X-POWER PRO END MILLS

TitaNox-POWER END MILLS

JET-POWER END MILLS

V7 PLUS END MILLS

ALU-POWER HPC END MILLS

ALU-POWER END MILLS

D-POWER GRAPHITE END MILLS

D-POWER CFRP END MILLS

ROUTERS

CRX S END MILLS

K-2 END MILLS

ONLY ONE COATED PM60 END MILLS

TANK-POWER END MILLS

GENERAL HSS END MILLS

MILLING CUTTERS

TECHNICAL DATA

SOLID CARBIDE
X5070
END MILLS

High Hardened Steels HRc45 to HRc70,
High Speed Machining, Dry Cutting



Please visit globalyg1.com/mat for material search

◎ : Excellent ○ : Good

Recommended cutting conditions : P 139

RIB PROCESSING	EXTENDED NECK	EXTENDED NECK	LONG LENGTH	EXTRA LONGLENGTH
Blue Coating	Blue Coating	Blue Coating	Blue Coating	Blue Coating

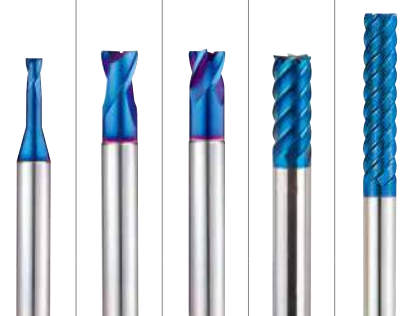

ISO	VDI 3323	Material Description	Composition / Structure / Heat Treatment	HB	HRc					
P	1	Non-alloy steel	About 0.15% C Annealed	125						
	2		About 0.45% C Annealed	190	13					
	3		About 0.45% C Quenched & Tempered	250	25					
	4		About 0.75% C Annealed	270	28					
	5		About 0.75% C Quenched & Tempered	300	32	○	○	○	○	○
	6	Low alloy steel	Annealed	180	10					
	7		Quenched & Tempered	275	29					
	8		Quenched & Tempered	300	32	○	○	○	○	○
	9		Quenched & Tempered	350	38	○	○	○	○	○
	10		High alloyed steel, and tool steel	Annealed	200	15				
	11	Quenched & Tempered		325	35	○	○	○	○	○
M	12	Stainless steel	Ferritic / Martensitic Annealed	200	15					
	13		Martensitic Quenched & Tempered	240	23					
	14		Austenitic	180	10					
K	15	Grey cast iron	Pearlitic / ferritic	180	10					
	16		Pearlitic (Martensitic)	260	26					
	17	Nodular cast iron	Ferritic	160	3					
	18		Pearlitic	250	25					
	19	Malleable cast iron	Ferritic	130						
20	Pearlitic		230	21						
N	21	Aluminum-wrought alloy	Not Curable	60						
	22		Curable Hardened	100						
	23	Aluminum-cast, alloyed	≤ 12% Si, Not Curable	75						
	24		≤ 12% Si, Curable Hardened	90						
	25		> 12% Si, Not Curable	130						
	26	Copper and Copper Alloys (Bronze / Brass)	Cutting Alloys, PB>1%	110						
	27		CuZn, CuSnZn (Brass)	90						
	28		CuSn, lead-free copper and electrolytic copper	100						
	29	Non Metallic Materials	Duroplastic, Fiber Reinforced Plastic							
	30		Rubber, Wood, etc.							
S	31	Heat Resistant Super Alloys	Fe Based	Annealed	200	15				
	32			Cured	280	30				
	33		Ni or Co Based	Annealed	250	25				
	34			Cured	350	38				
	35			Cast	320	34				
36	Titanium Alloys	Pure Titanium	400 Rm							
37		Alpha + Beta Alloys Hardened	1050 Rm							
H	38	Hardened steel	Hardened	550	55	◎	◎	◎	◎	◎
	39		Hardened	630	60	◎	◎	◎	◎	◎
	40	Chilled Cast Iron	Cast	400	42	○	○	○	○	○
	41	Hardened Cast Iron	Hardened	550	55	◎	◎	◎	◎	◎

CARBIDE, 4 FLUTE STUB LENGTH CORNER RADIUS HIGH FEED

- VOLLHARTMETALL, 4 SCHNEIDEN EXTER KURZ ECKENRADIUS HOCHVORSCHUB
- Fraise carbure, 4 dents, torique, grande avance, extra-courte
- 4 TAGLIANTI, TORICA

- ▶ Excellent wear resistance at heavy feed rates on high hardened material.
- ▶ Designed with reduced clearance angles and short flutes for strength.
- ▶ High hardness & heat resistance coating for long life in dry applications.

- ▶ Hervorragende Verschleißigenschaften bei hohen Schnittwerten in gehärteten Materialien
- ▶ Mit reduzierten Freiwinkeln und kurzen Spannuten für hohe Festigkeiten konstruiert.
- ▶ Große Härte u. hitzebeständige Beschichtung für lange Lebensdauer bei Trockenbearbeitung

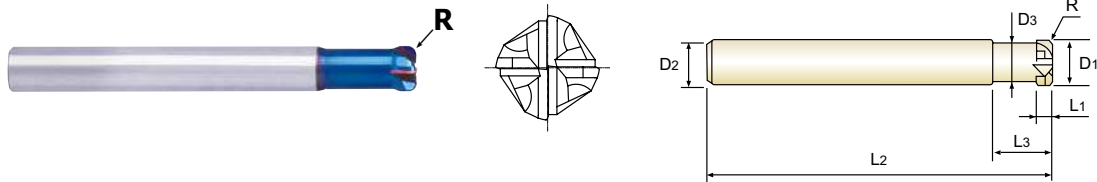

Unit : mm

EDP No.	Corner Radius	Mill Diameter	Shank Diameter	Length of Cut	Length Below Shank	Overall Length	Neck Diameter
	R (±0.005)	D1	D2	L1	L3	L2	D3
G8B5902005	R0.5	2.0	6	1	6	50	1.8
G8B5903005	R0.5	3.0	6	1.2	8	50	2.8
G8B5904005	R0.5	4.0	6	1.5	10	50	3.8
G8B5906005	R0.5	6.0	6	2.5	12	60	5.4
G8B5906010	R1.0	6.0	6	2.5	12	60	5.4
G8B5908010	R1.0	8.0	8	3.5	16	60	7.2
G8B5908020	R2.0	8.0	8	3.5	16	60	7.2
G8B5910010	R1.0	10.0	10	4	20	70	9
G8B5910020	R2.0	10.0	10	4	20	70	9
G8B5912020	R2.0	12.0	12	5	25	80	11
G8B5912030	R3.0	12.0	12	5	25	80	11

Mill Dia. Tolerance (mm)	Corner Radius Tolerance (mm)	Shank Dia. Tolerance
0 ~ -0.02	± 0.005	h5

Due to the characteristics of the blue decoration layer, it might be erased during short term use and the color layer might not be uniformed. However, it doesn't affect the performance of the tool.

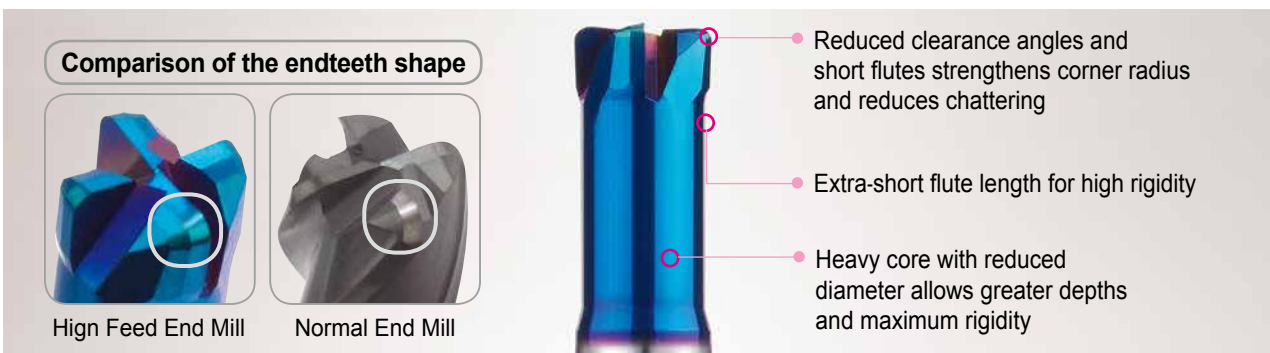

◎ : Excellent ○ : Good

ISO Material Description	P										M			K							
	Non-alloy steel					Low alloy steel					High alloyed steel, and tool steel			Stainless steel			Grey cast iron		Nodular cast iron		Malleable cast iron
VDI 3323	1	2	3	4	5	6	7	8	9	10	11	12	13	14	15	16	17	18	19	20	
HRC																					
HB	125	190	250	270	300	180	275	300	350	200	325	200	240	180	180	260	160	250	130	230	
Recommend					○				○	○											

ISO Material Description	N					S					H										
	Aluminum-wrought alloy		Aluminum-cast, alloyed		Copper and Copper Alloys (Bronze / Brass)	Non Metallic Materials		Heat Resistant Super Alloys			Titanium Alloys		Hardened steel	Chilled Cast Iron	Hardened Cast Iron						
VDI 3323	21	22	23	24	25	26	27	28	29	30	31	32	33	34	35	36	37	38	39	40	41
HRC																					
HB	60	100	75	90	130	110	90	100			200	280	250	350	320	400 Rm	1050 Rm	550	630	400	550
Recommend																		◎	◎	○	◎

YG X5070 END MILLS

PLAIN SHANK

G8B54 SERIES

CARBIDE, 4 FLUTE STUB LENGTH CORNER RADIUS HIGH FEED (long shank)

- **VOLLHARTMETALL, 4 SCHNEIDEN EXTER KURZ ECKENRADIUS HOCHVORSCHUB**
- **Fraise carbure, 4 dents, torique, grande avance, extra-courte**
- **4 TAGLIENTI, TORICA EXTRA LUNGA**

- ▶ Excellent wear resistance at heavy feed rates on high hardened material.
 - ▶ Designed with reduced clearance angles and short flutes for strength.
 - ▶ High hardness & heat resistance coating for long life in dry applications.
- ▶ Hervorragende Verschleißigenschaften bei hohen Schnittwerten in gehärteten Materialien
 - ▶ Mit reduzierten Freiwinkeln und kurzen Spannuten für hohe Festigkeiten konstruiert.
 - ▶ Große Härte u. hitzebeständige Beschichtung für lange Lebensdauer bei Trockenbearbeitung

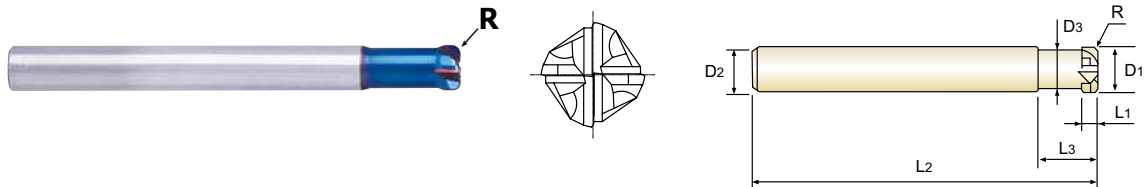

EDP No.	Corner Radius	Mill Diameter	Shank Diameter	Length of Cut	Length Below Shank	Overall Length	Neck Diameter
	R (±0.005)	D1	D2	L1	L3	L2	D3
G8B5402005	R0.5	2.0	6	1	6	70	1.8
G8B5403005	R0.5	3.0	6	1.2	8	70	2.8
G8B5404005	R0.5	4.0	6	1.5	10	70	3.8
G8B5405005	R0.5	5.0	6	2	10	70	4.6
G8B5406005	R0.5	6.0	6	2.5	12	90	5.4
G8B5406010	R1.0	6.0	6	2.5	12	90	5.4
G8B5408010	R1.0	8.0	8	3.5	16	100	7.2
G8B5408020	R2.0	8.0	8	3.5	16	100	7.2
G8B5410010	R1.0	10.0	10	4	20	100	9
G8B5410020	R2.0	10.0	10	4	20	100	9
G8B5412020	R2.0	12.0	12	5	25	110	11
G8B5412030	R3.0	12.0	12	5	25	110	11
G8B5416030	R3.0	16.0	16	6.5	30	130	15

Due to the characteristics of the blue decoration layer, it might be erased during short term use and the color layer might not be uniformed. However, it doesn't affect the performance of the tool.

Mill Dia. Tolerance (mm)	Corner Radius Tolerance (mm)	Shank Dia. Tolerance
0 ~ -0.02	± 0.005	h5

Comparison of the endteeth shape



High Feed End Mill



Normal End Mill



- Reduced clearance angles and short flutes strengthens corner radius and reduces chattering
- Extra-short flute length for high rigidity
- Heavy core with reduced diameter allows greater depths and maximum rigidity

◎ : Excellent ○ : Good

ISO Material Description	P											M			K					
	Non-alloy steel					Low alloy steel			High alloyed steel, and tool steel			Stainless steel			Grey cast iron		Nodular cast iron		Malleable cast iron	
VDI 3323	1	2	3	4	5	6	7	8	9	10	11	12	13	14	15	16	17	18	19	20
HRc		13	25	28	32	10	29	32	38	15	35	15	23	10	10	26	3	25	42	55
HB	125	190	250	270	300	180	275	300	350	200	325	200	240	180	180	260	160	250	130	230
Recommend					○					○	○									

ISO Material Description	N										S							H			
	Aluminum-wrought alloy		Aluminum-cast, alloyed			Copper and Copper Alloys (Bronze / Brass)			Non Metallic Materials		Heat Resistant Super Alloys					Titanium Alloys		Hardened steel	Chilled Cast Iron	Hardened Cast Iron	
VDI 3323	21	22	23	24	25	26	27	28	29	30	31	32	33	34	35	36	37	38	39	40	41
HRc											15	30	25	38	34			55	60	42	55
HB	60	100	75	90	130	110	90	100			200	280	250	350	320	400 Rm	1050 Rm	550	630	400	550
Recommend																		◎	◎	○	◎

CARBIDE, 2 FLUTE BALL NOSE for RIB PROCESSING

- **VOLLHARTMETALL, 2 SCHNEIDEN STIRNRADIUS für SCHMALE RIPPEN**
- **Fraise carbure, 2 dents, hémisphérique pour usinage de rainure**
- **2 TAGLIENTI, SEMISFERICA, SCARICATA PER NERVATURE**

- ▶ Designed to machine high hardened materials.
- ▶ Suitable for dry cutting, high speed cutting thanks to newly developed raw-material and new coating.
- ▶ Excellent workpiece finish.
- ▶ Designed for high precision milling operation.
- ▶ Higher wear-resistance.

- ▶ Geeignet zum Fräsen hochgehärteter Stähle.
- ▶ Geeignet zum Trockenfräsen und HSC-Fräsen dank neuentwickeltem Material und Beschichtung.
- ▶ Excellente Werkstückoberflächen.
- ▶ Geeignet für hochpräzises Fräsen.
- ▶ Höhere Verschleißfestigkeit.

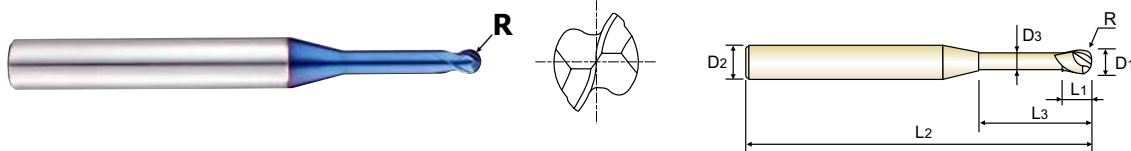

CARBIDE 2 BLUE 30° ±0.005 PLAIN P.140-141

Unit : mm

EDP No.	Radius of Ball Nose	Mill Diameter	Shank Diameter	Length of Cut	Length Below Shank	Overall Length	Neck Diameter
	R (±0.005)	D1	D2	L1	L3	L2	D3
G8A46805	R0.05	0.1	4	0.1	0.3	45	0.085
G8A46806	R0.05	0.1	4	0.1	0.5	45	0.085
G8A46002	R0.1	0.2	4	0.2	0.5	45	0.17
G8A46977	R0.1	0.2	4	0.2	1	45	0.17
G8A46958	R0.1	0.2	4	0.2	1.5	45	0.17
G8A46003	R0.15	0.3	4	0.3	1	45	0.27
G8A46959	R0.15	0.3	4	0.3	2	45	0.27
G8A46986	R0.15	0.3	4	0.3	3	45	0.27
G8A46004	R0.2	0.4	4	0.4	1	45	0.37
G8A46960	R0.2	0.4	4	0.4	2	45	0.37
G8A46961	R0.2	0.4	4	0.4	3	45	0.37
G8A46981	R0.2	0.4	4	0.4	4	45	0.37
G8A46987	R0.2	0.4	4	0.4	5	45	0.37
G8A46005	R0.25	0.5	4	0.4	2	45	0.45
G8A46804	R0.25	0.5	4	0.4	2.5	45	0.45
G8A46962	R0.25	0.5	4	0.4	4	45	0.45
G8A46963	R0.25	0.5	4	0.4	6	45	0.45
G8A46964	R0.25	0.5	4	0.4	8	45	0.45
G8A46957	R0.3	0.6	4	0.5	2	45	0.55
G8A46988	R0.3	0.6	4	0.5	3	45	0.55
G8A46915	R0.3	0.6	4	0.5	4	45	0.55
G8A46989	R0.3	0.6	4	0.5	5	45	0.55

Due to the characteristics of the blue decoration layer, it might be erased during short term use and the color layer might not be uniformed. However, it doesn't affect the performance of the tool. ▶ NEXT PAGE

Mill Dia. Tolerance (mm)	Shank Dia. Tolerance
0 ~ - 0.012	h5

◎ : Excellent ○ : Good

ISO Material Description	P									M						K					
	Non-alloy steel					Low alloy steel				High alloyed steel, and tool steel	Stainless steel			Grey cast iron		Nodular cast iron		Malleable cast iron			
VDI 3323	1	2	3	4	5	6	7	8	9	10	11	12	13	14	15	16	17	18	19	20	
HRC																					
HB	125	190	250	270	300	180	275	300	350	200	325	200	240	180	180	260	160	250	130	230	
Recommend					○				○		○										

ISO Material Description	N					S										H					
	Aluminum-wrought alloy		Aluminum-cast, alloyed		Copper and Copper Alloys (Bronze / Brass)	Non Metallic Materials	Heat Resistant Super Alloys					Titanium Alloys		Hardened steel	Chilled Cast Iron	Hardened Cast Iron					
VDI 3323	21	22	23	24	25	26	27	28	29	30	31	32	33	34	35	36	37	38	39	40	41
HRC																					
HB	60	100	75	90	130	110	90	100			200	280	250	350	320	400 Rm	1050 Rm	550	630	400	550
Recommend																		◎	◎	○	◎



CARBIDE, 2 FLUTE BALL NOSE for RIB PROCESSING

- **VOLLHARTMETALL, 2 SCHNEIDEN STIRNRADIUS für SCHMALE RIPPEN**
- **Fraise carbure, 2 dents, hémisphérique pour usinage de rainure**
- **2 TAGLIENTI, SEMISFERICA, SCARICATA PER NERVATURE**

- ▶ Designed to machine high hardened materials.
 - ▶ Suitable for dry cutting, high speed cutting thanks to newly developed raw-material and new coating.
 - ▶ Excellent workpiece finishes.
 - ▶ Designed for high precision milling operation.
 - ▶ Higher wear-resistance.
- ▶ Geeignet zum Fräsen hochgehärteter Stähle.
 - ▶ Geeignet zum Trockenfräsen und HSC-Fräsen dank neuentwickeltem Material und Beschichtung.
 - ▶ Exzellente Werkstückoberflächen.
 - ▶ Geeignet für hochpräzises Fräsen.
 - ▶ Höhere Verschleißfestigkeit.

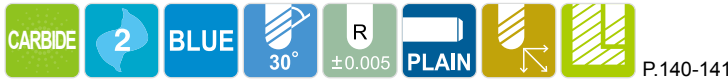
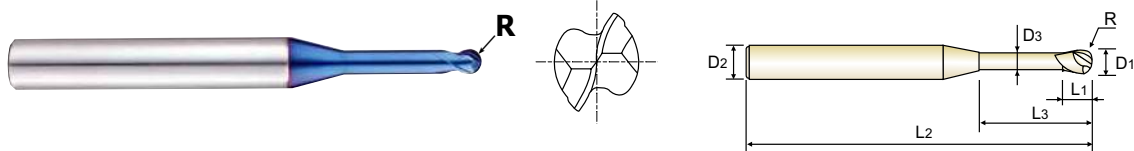

Unit : mm

EDP No.	Radius of Ball Nose	Mill Diameter	Shank Diameter	Length of Cut	Length Below Shank	Overall Length	Neck Diameter
	R (±0.005)	D1	D2	L1	L3	L2	D3
G8A46916	R0.3	0.6	4	0.5	6	45	0.55
G8A46917	R0.3	0.6	4	0.5	8	45	0.55
G8A46990	R0.3	0.6	4	0.5	10	45	0.55
G8A46918	R0.4	0.8	4	0.6	2	45	0.75
G8A46919	R0.4	0.8	4	0.6	4	45	0.75
G8A46008	R0.4	0.8	4	0.6	6	45	0.75
G8A46901	R0.4	0.8	4	0.6	8	45	0.75
G8A46965	R0.4	0.8	4	0.6	10	45	0.75
G8A46920	R0.5	1.0	4	0.8	3	45	0.95
G8A46921	R0.5	1.0	4	0.8	4	45	0.95
G8A46923	R0.5	1.0	4	0.8	5	45	0.95
G8A46010	R0.5	1.0	4	0.8	6	45	0.95
G8A46924	R0.5	1.0	4	0.8	7	45	0.95
G8A46902	R0.5	1.0	4	0.8	8	45	0.95
G8A46925	R0.5	1.0	4	0.8	9	45	0.95
G8A46903	R0.5	1.0	4	0.8	10	45	0.95
G8A46904	R0.5	1.0	4	0.8	12	45	0.95
G8A46926	R0.5	1.0	4	0.8	14	50	0.95
G8A46927	R0.5	1.0	4	0.8	16	50	0.95
G8A46966	R0.5	1.0	4	0.8	20	55	0.95
G8A46982	R0.6	1.2	4	1.0	6	45	1.15
G8A46012	R0.6	1.2	4	1.0	8	45	1.15

Due to the characteristics of the blue decoration layer, it might be erased during short term use and the color layer might not be uniformed. However, it doesn't affect the performance of the tool. ▶ NEXT PAGE

Mill Dia. Tolerance (mm)	Shank Dia. Tolerance
0 ~ - 0.012	h5

◎ : Excellent ○ : Good

ISO Material Description	P											M				K					
	Non-alloy steel					Low alloy steel				High alloyed steel, and tool steel		Stainless steel				Grey cast iron		Nodular cast iron		Malleable cast iron	
VDI 3323	1	2	3	4	5	6	7	8	9	10	11	12	13	14	15	16	17	18	19	20	
HRc	13	25	28	32	10	29	32	38	15	35	15	23	10	10	26	3	25				
HB	125	190	250	270	300	180	275	300	350	200	325	200	240	180	180	260	160	250	130	230	
Recommend					○				○		○										
ISO Material Description	N										S							H			
	Aluminum-wrought alloy		Aluminum-cast, alloyed			Copper and Copper Alloys (Bronze / Brass)			Non Metallic Materials		Heat Resistant Super Alloys					Titanium Alloys		Hardened steel	Chilled Cast Iron	Hardened Cast Iron	
VDI 3323	21	22	23	24	25	26	27	28	29	30	31	32	33	34	35	36	37	38	39	40	41
HRc											15	30	25	38	34			55	60	42	55
HB	60	100	75	90	130	110	90	100			200	280	250	350	320	400 Rm	1050 Rm	550	630	400	550
Recommend																		◎	◎	○	◎

CARBIDE, 2 FLUTE BALL NOSE for RIB PROCESSING

- **VOLLHARTMETALL, 2 SCHNEIDEN STIRNRADIUS für SCHMALE RIPPEN**
- **Fraise carbure, 2 dents, hémisphérique pour usinage de rainure**
- **2 TAGLIANTI, SEMISFERICA, SCARICATA PER NERVATURE**

- ▶ Designed to machine high hardened materials.
- ▶ Suitable for dry cutting, high speed cutting thanks to newly developed raw-material and new coating.
- ▶ Excellent workpiece finish.
- ▶ Designed for high precision milling operation.
- ▶ Higher wear-resistance.

- ▶ Geeignet zum Fräsen hochgehärteter Stähle.
- ▶ Geeignet zum Trockenfräsen und HSC-Fräsen dank neuentwickeltem Material und Beschichtung.
- ▶ Excellente Werkstückoberflächen.
- ▶ Geeignet für hochpräzises Fräsen.
- ▶ Höhere Verschleißfestigkeit.

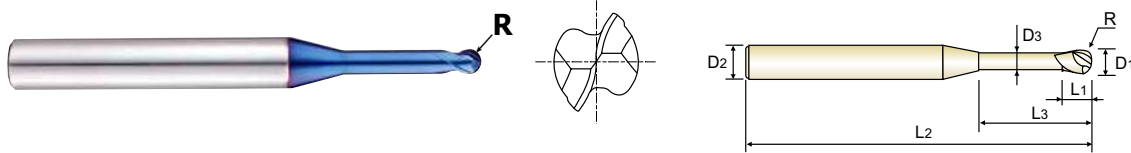

CARBIDE 2 BLUE 30° ±0.005 PLAIN P.140-141

Unit : mm

EDP No.	Radius of Ball Nose	Mill Diameter	Shank Diameter	Length of Cut	Length Below Shank	Overall Length	Neck Diameter
	R (±0.005)	D1	D2	L1	L3	L2	D3
G8A46983	R0.6	1.2	4	1.0	10	45	1.15
G8A46905	R0.6	1.2	4	1.0	12	45	1.15
G8A46930	R0.75	1.5	4	1.2	6	45	1.45
G8A46015	R0.75	1.5	4	1.2	8	45	1.45
G8A46931	R0.75	1.5	4	1.2	10	45	1.45
G8A46906	R0.75	1.5	4	1.2	12	45	1.45
G8A46992	R0.75	1.5	4	1.2	14	50	1.45
G8A46907	R0.75	1.5	4	1.2	16	50	1.45
G8A46932	R0.75	1.5	4	1.2	20	55	1.45
G8A46939	R1.0	2.0	4	1.6	4	45	1.95
G8A46940	R1.0	2.0	4	1.6	6	45	1.95
G8A46020	R1.0	2.0	4	1.6	8	45	1.95
G8A46941	R1.0	2.0	4	1.6	10	45	1.95
G8A46942	R1.0	2.0	4	1.6	12	50	1.95
G8A46943	R1.0	2.0	4	1.6	14	50	1.95
G8A46909	R1.0	2.0	4	1.6	16	50	1.95
G8A46993	R1.0	2.0	4	1.6	18	55	1.95
G8A46910	R1.0	2.0	4	1.6	20	55	1.95
G8A46944	R1.0	2.0	4	1.6	22	60	1.95
G8A46945	R1.0	2.0	4	1.6	25	60	1.95
G8A46967	R1.0	2.0	4	1.6	30	70	1.95
G8A46948	R1.5	3.0	6	2.4	12	50	2.85

Due to the characteristics of the blue decoration layer, it might be erased during short term use and the color layer might not be uniformed. However, it doesn't affect the performance of the tool. ▶ NEXT PAGE

Mill Dia. Tolerance (mm)	Shank Dia. Tolerance
0 ~ - 0.012	h5

◎ : Excellent ○ : Good

ISO Material Description	P										M				K						
	Non-alloy steel					Low alloy steel					High alloyed steel, and tool steel				Stainless steel		Grey cast iron		Nodular cast iron		Malleable cast iron
VDI 3323	1	2	3	4	5	6	7	8	9	10	11	12	13	14	15	16	17	18	19	20	
HRC		13	25	28	32	10	29	32	38	15	35	15	23	10	10	26	3	25	42	21	
HB	125	190	250	270	300	180	275	300	350	200	325	200	240	180	180	260	160	250	130	230	
Recommend					○				○		○										

ISO Material Description	N					S										H					
	Aluminum-wrought alloy		Aluminum-cast, alloyed			Copper and Copper Alloys (Bronze / Brass)			Non Metallic Materials		Heat Resistant Super Alloys					Titanium Alloys		Hardened steel	Chilled Cast Iron	Hardened Cast Iron	
VDI 3323	21	22	23	24	25	26	27	28	29	30	31	32	33	34	35	36	37	38	39	40	41
HRC											15	30	25	38	34			55	60	42	55
HB	60	100	75	90	130	110	90	100			200	280	250	350	320	400 Rm	1050 Rm	550	630	400	550
Recommend																		◎	◎	○	◎



CARBIDE, 2 FLUTE BALL NOSE for RIB PROCESSING

- **VOLLHARTMETALL, 2 SCHNEIDEN STIRNRADIUS für SCHMALE RIPPEN**
- **Fraise carbure, 2 dents, hémisphérique pour usinage de rainure**
- **2 TAGLIENTI, SEMISFERICA, SCARICATA PER NERVATURE**

- ▶ Designed to machine high hardened materials.
- ▶ Suitable for dry cutting, high speed cutting thanks to newly developed raw-material and new coating.
- ▶ Excellent workpiece finish.
- ▶ Designed for high precision milling operation.
- ▶ Higher wear-resistance.

- ▶ Geeignet zum Fräsen hochgehärteter Stähle.
- ▶ Geeignet zum Trockenfräsen und HSC-Fräsen dank neuentwickeltem Material und Beschichtung.
- ▶ Excellente Werkstückoberflächen.
- ▶ Geeignet für hochpräzises Fräsen.
- ▶ Höhere Verschleißfestigkeit.

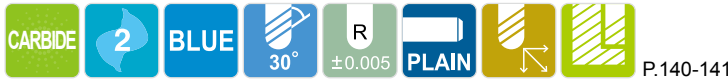
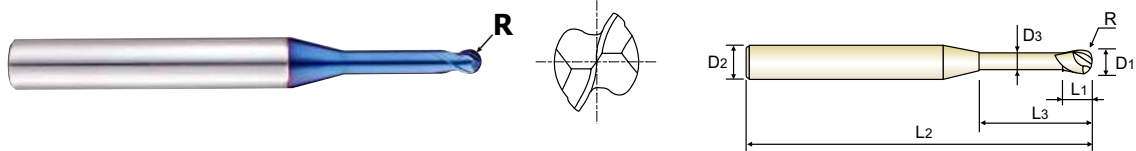

Unit : mm

EDP No.	Radius of Ball Nose	Mill Diameter	Shank Diameter	Length of Cut	Length Below Shank	Overall Length	Neck Diameter
	R (±0.005)	D1	D2	L1	L3	L2	D3
G8A46984	R1.5	3.0	6	2.4	14	55	2.85
G8A46030	R1.5	3.0	6	2.4	16	55	2.85
G8A46985	R1.5	3.0	6	2.4	18	60	2.85
G8A46911	R1.5	3.0	6	2.4	20	60	2.85
G8A46968	R1.5	3.0	6	2.4	25	65	2.85
G8A46969	R1.5	3.0	6	2.4	30	70	2.85
G8A46970	R1.5	3.0	6	2.4	35	80	2.85
G8A46950	R2.0	4.0	6	3.2	12	60	3.85
G8A46040	R2.0	4.0	6	3.2	16	60	3.85
G8A46912	R2.0	4.0	6	3.2	20	65	3.85
G8A46913	R2.0	4.0	6	3.2	25	70	3.85
G8A46971	R2.0	4.0	6	3.2	30	70	3.85
G8A46972	R2.0	4.0	6	3.2	35	80	3.85
G8A46973	R2.0	4.0	6	3.2	40	90	3.85
G8A46974	R2.0	4.0	6	3.2	45	90	3.85
G8A46975	R2.0	4.0	6	3.2	50	100	3.85

Due to the characteristics of the blue decoration layer, it might be erased during short term use and the color layer might not be uniformed. However, it doesn't affect the performance of the tool. ▶ NEXT PAGE

Mill Dia. Tolerance (mm)	Shank Dia. Tolerance
0 ~ - 0.012	h5

◎ : Excellent ○ : Good

ISO Material Description	P											M			K						
	Non-alloy steel					Low alloy steel				High alloyed steel, and tool steel		Stainless steel			Grey cast iron		Nodular cast iron		Malleable cast iron		
VDI 3323	1	2	3	4	5	6	7	8	9	10	11	12	13	14	15	16	17	18	19	20	
HRc	13	25	28	32	10	29	32	38	15	35	15	23	10	10	26	3	25				
HB	125	190	250	270	300	180	275	300	350	200	325	200	240	180	180	260	160	250	130	230	
Recommend					○				○		○										
ISO Material Description	N										S							H			
	Aluminum-wrought alloy		Aluminum-cast, alloyed			Copper and Copper Alloys (Bronze / Brass)			Non Metallic Materials		Heat Resistant Super Alloys					Titanium Alloys		Hardened steel	Chilled Cast Iron	Hardened Cast Iron	
VDI 3323	21	22	23	24	25	26	27	28	29	30	31	32	33	34	35	36	37	38	39	40	41
HRc											15	30	25	38	34			55	60	42	55
HB	60	100	75	90	130	110	90	100			200	280	250	350	320	400 Rm	1050 Rm	550	630	400	550
Recommend																		◎	◎	○	◎

CARBIDE, 2 FLUTE BALL NOSE for RIB PROCESSING

- VOLLHARTMETALL, 2 SCHNEIDEN STIRNRADIUS für SCHMALE RIPPEN
- Fraise carbure, 2 dents, hémisphérique pour usinage de rainure
- 2 TAGLIENTI, SEMISFERICA, SCARICATA PER NERVATURE

- ▶ Designed to machine high hardened materials.
 - ▶ Suitable for dry cutting, high speed cutting thanks to newly developed raw-material and new coating.
 - ▶ Excellent workpiece finish.
 - ▶ Designed for high precision milling operation.
 - ▶ Higher wear-resistance.
- ▶ Geeignet zum Fräsen hochgehärteter Stähle.
 - ▶ Geeignet zum Trockenfräsen und HSC-Fräsen dank neuentwickeltem Material und Beschichtung.
 - ▶ Excellente Werkstückoberflächen.
 - ▶ Geeignet für hochpräzises Fräsen.
 - ▶ Höhere Verschleißfestigkeit.

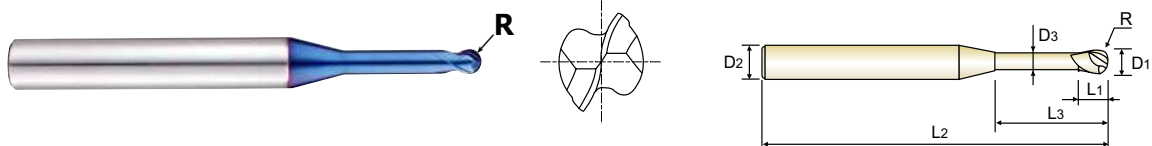

CARBIDE 2 BLUE 30° ±0.005 PLAIN P.140-141

EDP No.	Radius of Ball Nose	Mill Diameter	Shank Diameter	Length of Cut	Length Below Shank	Overall Length	Neck Diameter
	R (±0.005)	D1	D2	L1	L3	L2	D3
G8A54005	R0.25	0.5	6	0.5	1.5	50	0.45
G8A54901	R0.25	0.5	6	0.5	3.3	50	0.45
G8A54006	R0.3	0.6	6	0.6	2	50	0.55
G8A54902	R0.3	0.6	6	0.6	4	50	0.55
G8A54008	R0.4	0.8	6	0.8	2.5	50	0.75
G8A54903	R0.4	0.8	6	0.8	5.5	50	0.75
G8A54010	R0.5	1.0	6	1	3.3	50	0.95
G8A54904	R0.5	1.0	6	1	6.7	50	0.95
G8A54905	R0.5	1.0	6	1	12	50	0.95
G8A54012	R0.6	1.2	6	1.2	4.4	50	1.15
G8A54906	R0.6	1.2	6	1.2	8	50	1.15
G8A54015	R0.75	1.5	6	1.5	5	50	1.45
G8A54907	R0.75	1.5	6	1.5	9.7	50	1.45
G8A54908	R0.75	1.5	6	1.5	15	50	1.45
G8A54020	R1.0	2.0	6	2	6	50	1.95
G8A54909	R1.0	2.0	6	2	13	50	1.95
G8A54910	R1.0	2.0	6	2	20	60	1.95

Due to the characteristics of the blue decoration layer, it might be erased during short term use and the color layer might not be uniformed. However, it doesn't affect the performance of the tool.

Mill Dia. Tolerance (mm)	Shank Dia. Tolerance
0 ~ -0.012	h5

ISO Material Description	P										M				K							
	Non-alloy steel					Low alloy steel					High alloyed steel, and tool steel				Stainless steel			Grey cast iron		Nodular cast iron		Malleable cast iron
VDI 3323	1	2	3	4	5	6	7	8	9	10	11	12	13	14	15	16	17	18	19	20		
HRC		13	25	28	32	10	29	32	38	15	35	15	23	10	10	26	3	25	21	21		
HB	125	190	250	270	300	180	275	300	350	200	325	200	240	180	180	260	160	250	130	230		
Recommend					○				○	○	○											

ISO Material Description	N					S										H					
	Aluminum-wrought alloy		Aluminum-cast, alloyed			Copper and Copper Alloys (Bronze / Brass)			Non Metallic Materials		Heat Resistant Super Alloys					Titanium Alloys		Hardened steel	Chilled Cast Iron	Hardened Cast Iron	
VDI 3323	21	22	23	24	25	26	27	28	29	30	31	32	33	34	35	36	37	38	39	40	41
HRC											15	30	25	38	34			55	60	42	55
HB	60	100	75	90	130	110	90	100			200	280	250	350	320	400 Rm	1050 Rm	550	630	400	550
Recommend																		◎	◎	○	◎

YG X5070 END MILLS

PLAIN SHANK

G8A28 SERIES

CARBIDE, 2 FLUTE BALL NOSE

- **VOLLHARTMETALL, 2 SCHNEIDEN STIRNRADIUS**
- **Fraise carbure, 2 dents, hémisphérique**
- **2 TAGLIENTI, SEMISFERICA**

- ▶ Designed to machine high hardened materials.
- ▶ Suitable for dry cutting, high speed cutting thanks to newly developed raw-material and new coating.
- ▶ Excellent workpiece finish.
- ▶ Designed for high precision milling operation.
- ▶ Higher wear-resistance.

- ▶ Geeignet zum Fräsen hochgehärteter Stähle.
- ▶ Geeignet zum Trockenfräsen und HSC-Fräsen dank neuentwickeltem Material und Beschichtung.
- ▶ Excellente Werkstückoberflächen.
- ▶ Geeignet für hochpräzises Fräsen.
- ▶ Höhere Verschleißfestigkeit.

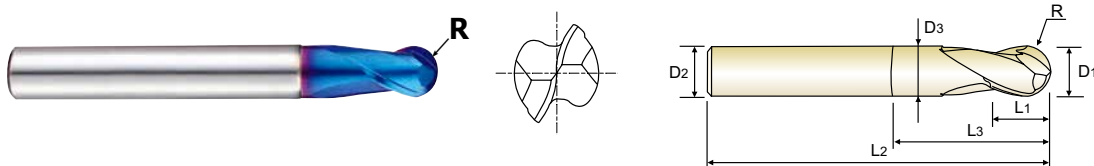

CARBIDE
2
BLUE
30°
R ±0.005
R ±0.010
PLAIN
P.142-143

EDP No.	Radius of Ball Nose	Mill Diameter	Shank Diameter	Length of Cut	Length Below Shank	Overall Length	Neck Diameter
	R	D1	D2	L1	L3	L2	D3
G8A28001	R0.05	0.1	4	0.2	-	40	-
G8A28002	R0.1	0.2	4	0.3	-	40	-
G8A28003	R0.15	0.3	4	0.5	-	40	-
G8A28004	R0.2	0.4	4	0.6	-	40	-
G8A28005	R0.25	0.5	4	0.7	-	40	-
G8A28006	R0.3	0.6	4	0.9	-	40	-
G8A28007	R0.35	0.7	4	1.1	-	40	-
G8A28008	R0.4	0.8	4	1.2	-	40	-
G8A28009	R0.45	0.9	4	1.4	-	40	-
G8A280104S	R0.5	1.0	4	1.5	3	50	0.95
G8A28010	R0.5	1.0	6	1.5	3	50	0.95
G8A280154S	R0.75	1.5	4	2	4	50	1.45
G8A28015	R0.75	1.5	6	2	4	50	1.45
G8A280204S	R1.0	2.0	4	2.5	5	50	1.95
G8A28020	R1.0	2.0	6	2.5	5	50	1.95
G8A280254S	R1.25	2.5	4	3	7	50	2.4
G8A28025	R1.25	2.5	6	3	7	50	2.4
G8A28030	R1.5	3.0	6	4	10	60	2.85
G8A28035	R1.75	3.5	6	4.5	10	60	3.35
G8A28040	R2.0	4.0	6	5	10	60	3.85
G8A28045	R2.25	4.5	6	5.5	10	60	4.35
G8A28050	R2.5	5.0	6	6	12	60	4.85

Due to the characteristics of the blue decoration layer, it might be erased during short term use and the color layer might not be uniformed. However, it doesn't affect the performance of the tool. ▶ NEXT PAGE

Size	Radius Tolerance (mm)	Mill Dia. Tolerance (mm)	Shank Dia. Tolerance
up to R3	± 0.005	0 ~ - 0.012	h5
over R3	± 0.010	0 ~ - 0.015	

◎ : Excellent ○ : Good

ISO Material Description	P											M			K						
	Non-alloy steel					Low alloy steel				High alloyed steel, and tool steel		Stainless steel			Grey cast iron		Nodular cast iron		Malleable cast iron		
VDI 3323	1	2	3	4	5	6	7	8	9	10	11	12	13	14	15	16	17	18	19	20	
HRc		13	25	28	32	10	29	32	38	15	35	15	23	10	10	26	3	25		21	
HB	125	190	250	270	300	180	275	300	350	200	325	200	240	180	180	260	160	250	130	230	
Recommend					○				○		○										
ISO Material Description	N										S						H				
	Aluminum-wrought alloy		Aluminum-cast, alloyed			Copper and Copper Alloys (Bronze / Brass)			Non Metallic Materials		Heat Resistant Super Alloys				Titanium Alloys		Hardened steel	Chilled Cast Iron	Hardened Cast Iron		
VDI 3323	21	22	23	24	25	26	27	28	29	30	31	32	33	34	35	36	37	38	39	40	41
HRc											15	30	25	38	34			55	60	42	55
HB	60	100	75	90	130	110	90	100			200	280	250	350	320	400 Rm	1050 Rm	550	630	400	550
Recommend																		◎	◎	○	◎

CARBIDE, 2 FLUTE BALL NOSE

- VOLLHARTMETALL, 2 SCHNEIDEN STIRNRADIUS
- Fraise carbure, 2 dents, hémisphérique
- 2 TAGLIANTI, SEMISFERICA

- ▶ Designed to machine high hardened materials.
- ▶ Suitable for dry cutting, high speed cutting thanks to newly developed raw-material and new coating.
- ▶ Excellent workpiece finish.
- ▶ Designed for high precision milling operation.
- ▶ Higher wear-resistance.

- ▶ Geeignet zum Fräsen hochgehärteter Stähle.
- ▶ Geeignet zum Trockenfräsen und HSC-Fräsen dank neuentwickeltem Material und Beschichtung.
- ▶ Excellente Werkstückoberflächen.
- ▶ Geeignet für hochpräzises Fräsen.
- ▶ Höhere Verschleißfestigkeit.

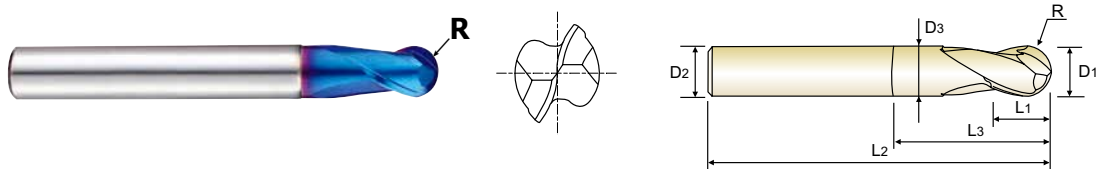

CARBIDE 2 BLUE 30° R ±0.005 R ±0.010 PLAIN P.142-143

R0.05-R3 R4-R6

Unit : mm

EDP No.	Radius of Ball Nose	Mill Diameter	Shank Diameter	Length of Cut	Length Below Shank	Overall Length	Neck Diameter
	R (±0.005)	D1	D2	L1	L3	L2	D3
G8A28055	R2.75	5.5	6	6.5	12	60	5.35
G8A28060	R3.0	6.0	6	7	15	60	5.85
G8A28903	R3.0	6.0	6	9	30	90	5.85
G8A28901	R4.0	8.0	8	9	15	60	7.7
G8A28080	R4.0	8.0	8	9	15	80	7.7
G8A28904	R4.0	8.0	8	12	30	100	7.7
G8A28902	R5.0	10.0	10	11	25	60	9.7
G8A28100	R5.0	10.0	10	11	25	80	9.7
G8A28905	R5.0	10.0	10	15	30	100	9.7
G8A28120	R6.0	12.0	12	14	25	80	11.7

Due to the characteristics of the blue decoration layer, it might be erased during short term use and the color layer might not be uniformed. However, it doesn't affect the performance of the tool.

Size	Radius Tolerance (mm)	Mill Dia. Tolerance (mm)	Shank Dia. Tolerance
up to R3	± 0.005	0 ~ - 0.012	h5
over R3	± 0.010	0 ~ - 0.015	

◎ : Excellent ○ : Good

ISO Material Description	P									M					K						
	Non-alloy steel					Low alloy steel				High alloyed steel, and tool steel	Stainless steel				Grey cast iron		Nodular cast iron		Malleable cast iron		
VDI 3323	1	2	3	4	5	6	7	8	9	10	11	12	13	14	15	16	17	18	19	20	
HRc		13	25	28	32	10	29	32	38	15	35	15	23	10	10	26	3	25	21	21	
HB	125	190	250	270	300	180	275	300	350	200	325	200	240	180	180	260	160	250	130	230	
Recommend					○				○	○											
ISO Material Description	N					S					H										
	Aluminum-wrought alloy		Aluminum-cast, alloyed			Copper and Copper Alloys (Bronze / Brass)			Non Metallic Materials		Heat Resistant Super Alloys					Titanium Alloys		Hardened steel	Chilled Cast Iron	Hardened Cast Iron	
VDI 3323	21	22	23	24	25	26	27	28	29	30	31	32	33	34	35	36	37	38	39	40	41
HRc											15	30	25	38	34			55	60	42	55
HB	60	100	75	90	130	110	90	100			200	280	250	350	320	400 Rm	1050 Rm	550	630	400	550
Recommend																		◎	◎	○	◎

YG X5070 END MILLS

PLAIN SHANK

G8A38 SERIES

CARBIDE, 2 FLUTE STUB LENGTH BALL NOSE with EXTENDED NECK

- **VOLLHARTMETALL, 2 SCHNEIDEN EXTRA KURZ STIRNRADIUS mit ABGESETZTEM SCHAFTTEIL**
- **Fraise carbure, 2 dents, hémisphérique, détalonnée, extra-courte**
- **2 TAGLIENTI, SEMISFERICA TAGLIENTE CORTO CON SCARICO ESTESO**

- ▶ Designed to machine high hardened materials.
 - ▶ Suitable for dry cutting, high speed cutting thanks to newly developed raw-material and new coating.
 - ▶ Excellent workpiece finish.
 - ▶ Designed for high precision milling operation.
 - ▶ Higher wear-resistance.
- ▶ Geeignet zum Fräsen hochgehärteter Stähle.
 - ▶ Geeignet zum Trockenfräsen und HSC-Fräsen dank neuentwickeltem Material und Beschichtung.
 - ▶ Excellente Werkstückoberflächen.
 - ▶ Geeignet für hochpräzises Fräsen.
 - ▶ Höhere Verschleißfestigkeit.

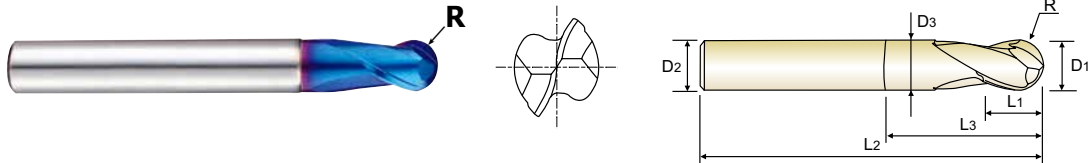

CARBIDE
2
BLUE
30°
R ±0.005
R ±0.010
PLAIN
P.142-143

R0.5-R3 R3.5-R12.5

Unit : mm

EDP No.	Radius of Ball Nose	Mill Diameter	Shank Diameter	Length of Cut	Length Below Shank	Overall Length	Neck Diameter
	R	D1	D2	L1	L3	L2	D3
G8A38010	R0.5	1.0	4	1	2.2	50	0.95
G8A38012	R0.6	1.2	4	1.2	2.6	50	1.15
G8A38015	R0.75	1.5	4	1.5	3	50	1.45
G8A380204S	R1.0	2.0	4	2	4	50	1.95
G8A38020	R1.0	2.0	6	2	4	50	1.95
G8A38030	R1.5	3.0	6	3	6	60	2.85
G8A38040	R2.0	4.0	6	4	8	70	3.85
G8A38050	R2.5	5.0	6	5	10	80	4.85
G8A38060	R3.0	6.0	6	6	12	90	5.85
G8A38070	R3.5	7.0	8	7	14	90	6.7
G8A38080	R4.0	8.0	8	8	16	100	7.7
G8A38090	R4.5	9.0	10	9	18	100	8.7
G8A38100	R5.0	10.0	10	10	20	100	9.7
G8A38120	R6.0	12.0	12	12	24	110	11.7
G8A38140	R7.0	14.0	14	14	28	110	13.7
G8A38160	R8.0	16.0	16	16	32	140	15.7
G8A38180	R9.0	18.0	18	18	36	140	17.7
G8A38200	R10.0	20.0	20	20	40	160	19.7
G8A38250	R12.5	25.0	25	25	50	180	24.7

Due to the characteristics of the blue decoration layer, it might be erased during short term use and the color layer might not be uniformed. However, it doesn't affect the performance of the tool.

Size	Radius Tolerance (mm)	Mill Dia. Tolerance (mm)	Shank Dia. Tolerance
up to R3	± 0.005	0 ~ - 0.012	h5
over R3	± 0.010	0 ~ - 0.015	

◎ : Excellent ○ : Good

ISO Material Description	P											M				K					
	Non-alloy steel					Low alloy steel				High alloyed steel, and tool steel		Stainless steel				Grey cast iron		Nodular cast iron		Malleable cast iron	
VDI 3323	1	2	3	4	5	6	7	8	9	10	11	12	13	14	15	16	17	18	19	20	
HRc	13	25	28	32	10	29	32	38	15	35	15	23	10	10	26	3	25				
HB	125	190	250	270	300	180	275	300	350	200	325	200	240	180	180	260	160	250	130	230	
Recommend					○				○		○										
ISO Material Description	N										S							H			
	Aluminum-wrought alloy		Aluminum-cast, alloyed			Copper and Copper Alloys (Bronze / Brass)			Non Metallic Materials		Heat Resistant Super Alloys					Titanium Alloys		Hardened steel	Chilled Cast Iron	Hardened Cast Iron	
VDI 3323	21	22	23	24	25	26	27	28	29	30	31	32	33	34	35	36	37	38	39	40	41
HRc											15	30	25	38	34			55	60	42	55
HB	60	100	75	90	130	110	90	100			200	280	250	350	320	400 Rm	1050 Rm	550	630	400	550
Recommend																		◎	◎	○	◎

CARBIDE, 2 FLUTE MINIATURE BALL NOSE

- **VOLLHARTMETALL, 2 SCHNEIDEN MINI STIRNRADIUS**
- () **Fraise carbure, 2 dents, hémisphérique, micro-fraise**
- () **2 TAGLIANTI, SEMISFERICA MINI**

- ▶ Designed to machine high hardened materials.
- ▶ Suitable for dry cutting, high speed cutting thanks to newly developed raw-material and new coating.
- ▶ Excellent workpiece finish.
- ▶ Designed for high precision milling operation.
- ▶ Higher wear-resistance.

- ▶ Geeignet zum Fräsen hochgehärteter Stähle.
- ▶ Geeignet zum Trockenfräsen und HSC-Fräsen dank neuentwickeltem Material und Beschichtung.
- ▶ Excellente Werkstückoberflächen.
- ▶ Geeignet für hochpräzises Fräsen.
- ▶ Höhere Verschleißfestigkeit.

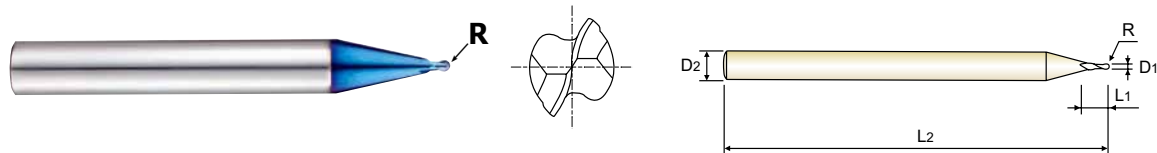

CARBIDE

2

BLUE

30°

R
±0.005

PLAIN

P.142-143

Unit : mm

EDP No.	Radius of Ball Nose	Mill Diameter	Shank Diameter	Length of Cut	Overall Length
	R (±0.005)	D1	D2	L1	L2
G8A53004	R0.2	0.4	6	0.4	50
G8A53005	R0.25	0.5	6	0.5	50
G8A53006	R0.3	0.6	6	0.6	50
G8A53008	R0.4	0.8	6	0.8	50
G8A53010	R0.5	1.0	6	1.0	50
G8A53012	R0.6	1.2	6	1.2	50
G8A53015	R0.75	1.5	6	1.5	50
G8A53020	R1.0	2.0	6	2.0	50

Due to the characteristics of the blue decoration layer, it might be erased during short term use and the color layer might not be uniformed. However, it doesn't affect the performance of the tool.

Mill Dia. Tolerance (mm)	Shank Dia. Tolerance
0 ~ - 0.012	h5

◎ : Excellent ○ : Good

ISO Material Description	P										M				K							
	Non-alloy steel					Low alloy steel					High alloyed steel, and tool steel				Stainless steel			Grey cast iron		Nodular cast iron		Malleable cast iron
VDI 3323	1	2	3	4	5	6	7	8	9	10	11	12	13	14	15	16	17	18	19	20		
HRC																						
HB	125	190	250	270	300	180	275	300	350	200	325	200	240	180	180	260	160	250	130	230		
Recommend					○				○		○											
ISO Material Description	N										S						H					
	Aluminum-wrought alloy		Aluminum-cast, alloyed			Copper and Copper Alloys (Bronze / Brass)			Non Metallic Materials		Heat Resistant Super Alloys						Titanium Alloys		Hardened steel	Chilled Cast Iron	Hardened Cast Iron	
VDI 3323	21	22	23	24	25	26	27	28	29	30	31	32	33	34	35	36	37	38	39	40	41	
HRC																						
HB	60	100	75	90	130	110	90	100			200	280	250	350	320	400 Rm	1050 Rm	550	630	400	550	
Recommend																		◎	◎	○	◎	



CARBIDE, 3 FLUTE BALL NOSE - Center Match

- **VOLLHARTMETALL, 3 SCHNEIDEN STIRNRADIUS - Schneiden Mittelpunkt**
- **Fraise carbure, 3 dents, hémisphérique, coupe au centre**
- **3 TAGLIENTI, SEMISFERICA**

- ▶ Designed to machine high hardened materials.
 - ▶ Suitable for dry cutting, high speed cutting thanks to newly developed raw-material and new coating.
 - ▶ Excellent workpiece finish.
 - ▶ Designed for high precision milling operation.
 - ▶ Higher wear-resistance.
- ▶ Geeignet zum Fräsen hochgehärteter Stähle.
 - ▶ Geeignet zum Trockenfräsen und HSC-Fräsen dank neuentwickeltem Material und Beschichtung.
 - ▶ Excellente Werkstückoberflächen.
 - ▶ Geeignet für hochpräzises Fräsen.
 - ▶ Höhere Verschleißfestigkeit.

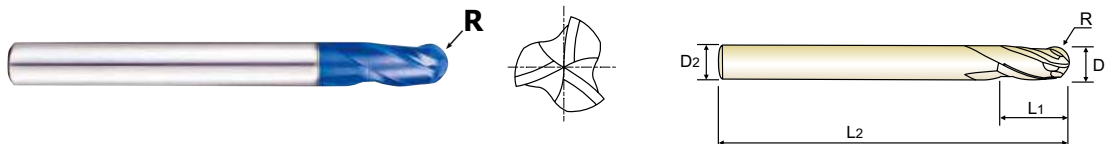

CARBIDE 3 BLUE 30° R ±0.005 R ±0.010 PLAIN P.144

Unit : mm

EDP No.	Radius of Ball Nose	Mill Diameter	Shank Diameter	Length of Cut	Overall Length
	R	D1	D2	L1	L2
G8A59030	R1.5	3.0	6	8	60
G8A59040	R2.0	4.0	6	8	70
G8A59050	R2.5	5.0	6	10	80
G8A59060	R3.0	6.0	6	12	90
G8A59080	R4.0	8.0	8	14	100
G8A59100	R5.0	10.0	10	18	100
G8A59120	R6.0	12.0	12	22	110
G8A59160	R8.0	16.0	16	30	140
G8A59200	R10.0	20.0	20	38	160

Due to the characteristics of the blue decoration layer, it might be erased during short term use and the color layer might not be uniformed. However, it doesn't affect the performance of the tool.

Size	Radius Tolerance (mm)	Mill Dia. Tolerance (mm)	Shank Dia. Tolerance
up to R3	± 0.005	0 ~ - 0.012	h5
over R3	± 0.010	0 ~ - 0.015	

◎ : Excellent ○ : Good

ISO Material Description	P											M			K						
	Non-alloy steel					Low alloy steel				High alloyed steel, and tool steel		Stainless steel			Grey cast iron		Nodular cast iron	Malleable cast iron			
VDI 3323	1	2	3	4	5	6	7	8	9	10	11	12	13	14	15	16	17	18	19	20	
HRc	13	25	28	32	10	29	32	38	15	35	15	23	10	10	26	3	25	42	55	21	
HB	125	190	250	270	300	180	275	300	350	200	325	200	240	180	180	260	160	250	130	230	
Recommend					○			○	○		○										
ISO Material Description	N										S						H				
	Aluminum-wrought alloy		Aluminum-cast, alloyed			Copper and Copper Alloys (Bronze / Brass)			Non Metallic Materials		Heat Resistant Super Alloys						Titanium Alloys		Hardened steel	Chilled Cast Iron	Hardened Cast Iron
VDI 3323	21	22	23	24	25	26	27	28	29	30	31	32	33	34	35	36	37	38	39	40	41
HRc											15	30	25	38	34			55	60	42	55
HB	60	100	75	90	130	110	90	100			200	280	250	350	320	400 Rm	1050 Rm	550	630	400	550
Recommend																		◎	◎	○	◎

CARBIDE, 4 FLUTE BALL NOSE - Center Match

- **VOLLHARTMETALL, 4 SCHNEIDEN STIRNRADIUS - Schneiden Mittelpunkt**
- **Fraise carbure, 4 dents, hémisphérique - coupe au centre**
- **4 TAGLIANTI, SEMISFERICA - 4 TAGLIANTI A CENTRO FRESA**

- ▶ Applied center match type & special new design on ball center shape.
- ▶ Excellent high wear resistance and high performance.
- ▶ Applied for high speed and feed.
- ▶ Increased the surface roughness.
- ▶ Neues Design der Kugelschneidengeometrie
- ▶ Hohe Verschleißfestigkeit, hohe Leistung.
- ▶ Geeignet für hohe Schnittgeschwindigkeiten und hohe Vorschübe
- ▶ verbessert deutlich die Oberflächenrauigkeit

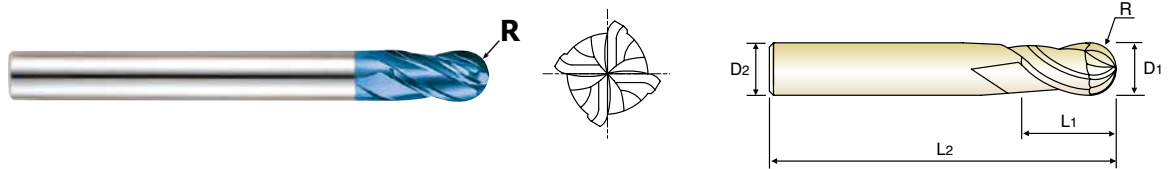

CARBIDE 4 BLUE 30° ±0.005 ±0.010 PLAIN P.145

R1.5-R3 R4-R10

Unit : mm

EDP No.	Radius of Ball Nose	Mill Diameter	Shank Diameter	Length of Cut	Overall Length
	R	D1	D2	L1	L2
G8D62030	R1.5	3.0	6	8	60
G8D62040	R2.0	4.0	6	8	70
G8D62050	R2.5	5.0	6	10	80
G8D62060	R3.0	6.0	6	12	90
G8D62080	R4.0	8.0	8	14	100
G8D62100	R5.0	10.0	10	18	100
G8D62120	R6.0	12.0	12	22	110
G8D62160	R8.0	16.0	16	30	140
G8D62200	R10.0	20.0	20	38	160

Due to the characteristics of the blue decoration layer, it might be erased during short term use and the color layer might not be uniformed. However, it doesn't affect the performance of the tool.

Size	Radius Tolerance (mm)	Mill Dia. Tolerance (mm)	Shank Dia. Tolerance
up to R3	± 0.005	0 ~ - 0.012	h5
over R3	± 0.010	0 ~ - 0.015	

◎ : Excellent ○ : Good

ISO Material Description	P										M			K							
	Non-alloy steel					Low alloy steel					High alloyed steel, and tool steel			Stainless steel			Grey cast iron		Nodular cast iron		Malleable cast iron
VDI 3323	1	2	3	4	5	6	7	8	9	10	11	12	13	14	15	16	17	18	19	20	
HRc		13	25	28	32	10	29	32	38	15	35	15	23	10	10	26	3	25	21		
HB	125	190	250	270	300	180	275	300	350	200	325	200	240	180	180	260	160	250	130	230	
Recommend					○				○	○	○										
ISO Material Description	N									S						H					
	Aluminum-wrought alloy		Aluminum-cast, alloyed			Copper and Copper Alloys (Bronze / Brass)			Non Metallic Materials		Heat Resistant Super Alloys						Titanium Alloys		Hardened steel	Chilled Cast Iron	Hardened Cast Iron
VDI 3323	21	22	23	24	25	26	27	28	29	30	31	32	33	34	35	36	37	38	39	40	41
HRc											15	30	25	38	34			55	60	42	55
HB	60	100	75	90	130	110	90	100			200	280	250	350	320	400 Rm	1050 Rm	550	630	400	550
Recommend																		◎	◎	○	◎

CARBIDE, 2 FLUTE CORNER RADIUS for RIB PROCESSING

- **VOLLHARTMETALL, 2 SCHNEIDEN ECKENRADIUS für SCHMALE RIPPEN**
- **Fraise carbure, 2 dents, torique pour usinage de rainure**
- **2 TAGLIENTI, TORICA, SCARICATA PER ENRVATURE**

- ▶ Designed to machine high hardened materials.
- ▶ Suitable for dry cutting, high speed cutting thanks to newly developed raw-material and new coating.
- ▶ Excellent workpiece finish.
- ▶ Deep slotting is possible by reduced neck.
- ▶ Corner radius for preventing the chipping in high speed machining.
- ▶ Higher wear-resistance.

- ▶ Geeignet zum Fräsen hochgehärteter Stähle.
- ▶ Geeignet zum Trockenfräsen und HSC-Fräsen dank neuentwickeltem Material und Beschichtung.
- ▶ Excellente Werkstückoberflächen.
- ▶ Abgesetzter Schaft für größere Reichweite.
- ▶ Schneidkantenschutz durch definierten Radius.
- ▶ Höhere Verschleißfestigkeit.

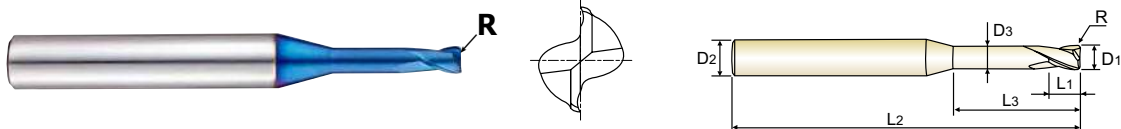

CARBIDE 2 BLUE 30° ±0.010 ±0.015 PLAIN P.146-147

EDP No.	Corner Radius	Mill Diameter	Shank Diameter	Length of Cut	Length Below Shank	Overall Length	Neck Diameter
	R	D1	D2	L1	L3	L2	D3
G8A60936	R0.05	0.5	4	0.7	1.5	45	0.45
G8A60932	R0.05	0.5	4	0.7	2.5	45	0.45
G8A60935	R0.05	0.5	4	0.7	4	45	0.45
G8A60931	R0.05	0.6	4	0.9	2	45	0.55
G8A60933	R0.05	0.6	4	0.9	3	45	0.55
G8A60934	R0.05	0.6	4	0.9	4	45	0.55
G8A600060102	R0.1	0.6	4	0.9	2	45	0.55
G8A600070104	R0.1	0.7	4	1	4	45	0.65
G8A600080102	R0.1	0.8	4	1.2	2	45	0.75
G8A60008	R0.1	0.8	4	1.2	4	45	0.75
G8A60924	R0.1	0.8	4	1.2	6	45	0.75
G8A609254S	R0.1	1.0	4	1.5	4	50	0.95
G8A609264S	R0.1	1.0	4	1.5	6	50	0.95
G8A600100204	R0.2	1.0	4	1.5	4	50	0.95
G8A600100206	R0.2	1.0	4	1.5	6	50	0.95
G8A609114S	R0.2	1.0	4	1.5	8	50	0.95
G8A600100304	R0.3	1.0	4	1.5	4	50	0.95
G8A600100306	R0.3	1.0	4	1.5	6	50	0.95
G8A60980	R0.3	1.0	4	1.5	8	50	0.95
G8A60925	R0.1	1.0	6	1.5	4	50	0.95
G8A60926	R0.1	1.0	6	1.5	6	50	0.95
G8A60010	R0.2	1.0	6	1.5	4	50	0.95

Due to the characteristics of the blue decoration layer, it might be erased during short term use and the color layer might not be uniformed. However, it doesn't affect the performance of the tool. ▶ NEXT PAGE

Size	Corner Radius Tolerance (mm)	Mill Dia. Tolerance (mm)	Shank Dia. Tolerance
up to Ø6	± 0.010	0 ~ - 0.012	h5
over Ø6	± 0.015	0 ~ - 0.015	

◎ : Excellent ○ : Good

ISO Material Description	P											M			K						
	Non-alloy steel					Low alloy steel				High alloyed steel, and tool steel		Stainless steel			Grey cast iron		Nodular cast iron		Malleable cast iron		
VDI 3323	1	2	3	4	5	6	7	8	9	10	11	12	13	14	15	16	17	18	19	20	
HRc		13	25	28	32	10	29	32	38	15	35	15	23	10	10	26	3	25		21	
HB	125	190	250	270	300	180	275	300	350	200	325	200	240	180	180	260	160	250	130	230	
Recommend					○				○		○										
ISO Material Description	N										S					H					
	Aluminum-wrought alloy		Aluminum-cast, alloyed			Copper and Copper Alloys (Bronze / Brass)			Non Metallic Materials		Heat Resistant Super Alloys					Titanium Alloys		Hardened steel	Chilled Cast Iron	Hardened Cast Iron	
VDI 3323	21	22	23	24	25	26	27	28	29	30	31	32	33	34	35	36	37	38	39	40	41
HRc											15	30	25	38	34			55	60	42	55
HB	60	100	75	90	130	110	90	100			200	280	250	350	320	400 Rm	1050 Rm	550	630	400	550
Recommend																		◎	◎	○	◎

CARBIDE, 2 FLUTE CORNER RADIUS for RIB PROCESSING

- VOLLHARTMETALL, 2 SCHNEIDEN ECKENRADIUS für SCHMALE RIPPEN
- Fraise carbure, 2 dents, torique pour usinage de rainure
- 2 TAGLIANTI, TORICA, SCARICATA PER ENRVATURE

- ▶ Designed to machine high hardened materials.
- ▶ Suitable for dry cutting, high speed cutting thanks to newly developed raw-material and new coating.
- ▶ Excellent workpiece finish.
- ▶ Deep slotting is possible by reduced neck.
- ▶ Corner radius for preventing the chipping in high speed machining.
- ▶ Higher wear-resistance.

- ▶ Geeignet zum Fräsen hochgehärteter Stähle.
- ▶ Geeignet zum Trockenfräsen und HSC-Fräsen dank neuentwickeltem Material und Beschichtung.
- ▶ Excellente Werkstückoberflächen.
- ▶ Abgesetzter Schaft für größere Reichweite.
- ▶ Schneidkantenschutz durch definierten Radius.
- ▶ Höhere Verschleißfestigkeit.

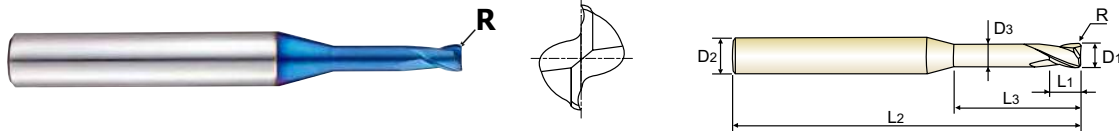

CARBIDE 2 BLUE 30° ±0.010 ±0.015 PLAIN P.146-147

Ø0.5-Ø6 Ø8-Ø12

Unit : mm

EDP No.	Corner Radius	Mill Diameter	Shank Diameter	Length of Cut	Length Below Shank	Overall Length	Neck Diameter
	R	D1	D2	L1	L3	L2	D3
G8A60910	R0.2	1.0	6	1.5	6	50	0.95
G8A60911	R0.2	1.0	6	1.5	8	50	0.95
G8A60912	R0.3	1.0	6	1.5	4	50	0.95
G8A60930	R0.3	1.0	6	1.5	6	50	0.95
G8A600100308	R0.3	1.0	6	1.5	8	50	0.95
G8A600154S	R0.2	1.5	4	2.5	4	50	1.45
G8A6001502064S	R0.2	1.5	4	2.5	6	50	1.45
G8A6001502084S	R0.2	1.5	4	2.5	8	50	1.45
G8A609134S	R0.2	1.5	4	2.5	10	50	1.45
G8A609144S	R0.2	1.5	4	2.5	12	50	1.45
G8A609154S	R0.3	1.5	4	2.5	4	50	1.45
G8A6001503064S	R0.3	1.5	4	2.5	6	50	1.45
G8A6001503084S	R0.3	1.5	4	2.5	8	50	1.45
G8A60015	R0.2	1.5	6	2.5	4	50	1.45
G8A600150206	R0.2	1.5	6	2.5	6	50	1.45
G8A600150208	R0.2	1.5	6	2.5	8	50	1.45
G8A60913	R0.2	1.5	6	2.5	10	50	1.45
G8A60914	R0.2	1.5	6	2.5	12	50	1.45
G8A60915	R0.3	1.5	6	2.5	4	50	1.45
G8A600150306	R0.3	1.5	6	2.5	6	50	1.45
G8A600150308	R0.3	1.5	6	2.5	8	50	1.45
G8A609274S	R0.2	2.0	4	3	6	50	1.95

Due to the characteristics of the blue decoration layer, it might be erased during short term use and the color layer might not be uniformed. However, it doesn't affect the performance of the tool. ▶ NEXT PAGE

Size	Corner Radius Tolerance (mm)	Mill Dia. Tolerance (mm)	Shank Dia. Tolerance
up to Ø6	± 0.010	0 ~ - 0.012	h5
over Ø6	± 0.015	0 ~ - 0.015	

◎ : Excellent ○ : Good

ISO Material Description	P										M			K							
	Non-alloy steel					Low alloy steel					High alloyed steel, and tool steel			Stainless steel			Grey cast iron		Nodular cast iron		Malleable cast iron
VDI 3323	1	2	3	4	5	6	7	8	9	10	11	12	13	14	15	16	17	18	19	20	
HRC		13	25	28	32	10	29	32	38	15	35	15	23	10	10	26	3	25	42	55	
HB	125	190	250	270	300	180	275	300	350	200	325	200	240	180	180	260	160	250	130	230	
Recommend	○										○			○							
ISO Material Description	N					S					H										
	Aluminum-wrought alloy		Aluminum-cast, alloyed			Copper and Copper Alloys (Bronze / Brass)			Non Metallic Materials		Heat Resistant Super Alloys			Titanium Alloys		Hardened steel		Chilled Cast Iron		Hardened Cast Iron	
VDI 3323	21	22	23	24	25	26	27	28	29	30	31	32	33	34	35	36	37	38	39	40	41
HRC											15	30	25	38	34			55	60	42	55
HB	60	100	75	90	130	110	90	100			200	280	250	350	320	400 Rm	1050 Rm	550	630	400	550
Recommend	○					○					○				◎		◎		◎		

YG X5070 END MILLS

PLAIN SHANK

G8A60 SERIES

CARBIDE, 2 FLUTE CORNER RADIUS for RIB PROCESSING

- **VOLLHARTMETALL, 2 SCHNEIDEN ECKENRADIUS für SCHMALE RIPPEN**
- 🇩🇪 **Fraise carbure, 2 dents, torique pour usinage de rainure**
- 🇮🇹 **2 TAGLIENTI, TORICA, SCARICATA PER ENRVATURE**

- ▶ Designed to machine high hardened materials.
- ▶ Suitable for dry cutting, high speed cutting thanks to newly developed raw-material and new coating.
- ▶ Excellent workpiece finish.
- ▶ Deep slotting is possible by reduced neck.
- ▶ Corner radius for preventing the chipping in high speed machining.
- ▶ Higher wear-resistance.

- ▶ Geeignet zum Fräsen hochgehärteter Stähle.
- ▶ Geeignet zum Trockenfräsen und HSC-Fräsen dank neuentwickeltem Material und Beschichtung.
- ▶ Excellente Werkstückoberflächen.
- ▶ Abgesetzter Schaft für größere Reichweite.
- ▶ Schneidkantenschutz durch definierten Radius.
- ▶ Höhere Verschleißfestigkeit.

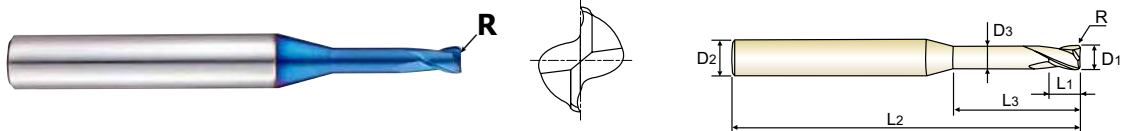

CARBIDE
2
BLUE
30°
±0.010
±0.015
PLAIN
P.146-147

EDP No.	Corner Radius	Mill Diameter	Shank Diameter	Length of Cut	Length Below Shank	Overall Length	Neck Diameter
	R	D1	D2	L1	L3	L2	D3
G8A6002002084S	R0.2	2.0	4	3	8	50	1.95
G8A6002002104S	R0.2	2.0	4	3	10	55	1.95
G8A6002002124S	R0.2	2.0	4	3	12	55	1.95
G8A609164S	R0.3	2.0	4	3	6	50	1.95
G8A6002003084S	R0.3	2.0	4	3	8	50	1.95
G8A6002003104S	R0.3	2.0	4	3	10	55	1.95
G8A6002003124S	R0.3	2.0	4	3	12	55	1.95
G8A6002003164S	R0.3	2.0	4	3	16	55	1.95
G8A609174S	R0.5	2.0	4	3	6	50	1.95
G8A600204S	R0.5	2.0	4	3	10	55	1.95
G8A609184S	R0.5	2.0	4	3	12	55	1.95
G8A60927	R0.2	2.0	6	3	6	50	1.95
G8A600200208	R0.2	2.0	6	3	8	50	1.95
G8A600200210	R0.2	2.0	6	3	10	55	1.95
G8A600200212	R0.2	2.0	6	3	12	55	1.95
G8A60916	R0.3	2.0	6	3	6	50	1.95
G8A600200308	R0.3	2.0	6	3	8	50	1.95
G8A600200310	R0.3	2.0	6	3	10	55	1.95
G8A600200312	R0.3	2.0	6	3	12	55	1.95
G8A600200316	R0.3	2.0	6	3	16	55	1.95
G8A60917	R0.5	2.0	6	3	6	50	1.95
G8A60020	R0.5	2.0	6	3	10	55	1.95

Due to the characteristics of the blue decoration layer, it might be erased during short term use and the color layer might not be uniformed. However, it doesn't affect the performance of the tool. ▶ NEXT PAGE

Size	Corner Radius Tolerance (mm)	Mill Dia. Tolerance (mm)	Shank Dia. Tolerance
up to Ø6	± 0.010	0 ~ - 0.012	h5
over Ø6	± 0.015	0 ~ - 0.015	

◎ : Excellent ○ : Good

ISO Material Description	P											M			K						
	Non-alloy steel					Low alloy steel				High alloyed steel, and tool steel		Stainless steel			Grey cast iron		Nodular cast iron		Malleable cast iron		
VDI 3323	1	2	3	4	5	6	7	8	9	10	11	12	13	14	15	16	17	18	19	20	
HRc		13	25	28	32	10	29	32	38	15	35	15	23	10	10	26	3	25		21	
HB	125	190	250	270	300	180	275	300	350	200	325	200	240	180	180	260	160	250	130	230	
Recommend					○				○		○										
ISO Material Description	N										S							H			
	Aluminum-wrought alloy		Aluminum-cast, alloyed			Copper and Copper Alloys (Bronze / Brass)			Non Metallic Materials		Heat Resistant Super Alloys					Titanium Alloys		Hardened steel	Chilled Cast Iron	Hardened Cast Iron	
VDI 3323	21	22	23	24	25	26	27	28	29	30	31	32	33	34	35	36	37	38	39	40	41
HRc											15	30	25	38	34			55	60	42	55
HB	60	100	75	90	130	110	90	100			200	280	250	350	320	400 Rm	1050 Rm	550	630	400	550
Recommend																		◎	◎	○	◎



X5070 END MILLS

PLAIN SHANK

G8A60 SERIES

CARBIDE, 2 FLUTE CORNER RADIUS for RIB PROCESSING

- VOLLHARTMETALL, 2 SCHNEIDEN ECKENRADIUS für SCHMALE RIPPEN
- Fraise carbure, 2 dents, torique pour usinage de rainure
- 2 TAGLIANTI, TORICA, SCARICATA PER ENRVATURE

- ▶ Designed to machine high hardened materials.
- ▶ Suitable for dry cutting, high speed cutting thanks to newly developed raw-material and new coating.
- ▶ Excellent workpiece finish.
- ▶ Deep slotting is possible by reduced neck.
- ▶ Corner radius for preventing the chipping in high speed machining.
- ▶ Higher wear-resistance.

- ▶ Geeignet zum Fräsen hochgehärteter Stähle.
- ▶ Geeignet zum Trockenfräsen und HSC-Fräsen dank neuentwickeltem Material und Beschichtung.
- ▶ Excellente Werkstückoberflächen.
- ▶ Abgesetzter Schaft für größere Reichweite.
- ▶ Schneidkantenschutz durch definierten Radius.
- ▶ Höhere Verschleißfestigkeit.

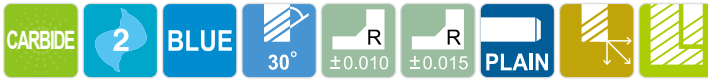

P.146-147

Ø0.5-Ø6 Ø8-Ø12

Unit : mm

EDP No.	Corner Radius	Mill Diameter	Shank Diameter	Length of Cut	Length Below Shank	Overall Length	Neck Diameter
	R	D1	D2	L1	L3	L2	D3
G8A60918	R0.5	2.0	6	3	12	55	1.95
G8A600300208	R0.2	3.0	6	4	8	55	2.85
G8A600300210	R0.2	3.0	6	4	10	55	2.85
G8A600300212	R0.2	3.0	6	4	12	55	2.85
G8A600300216	R0.2	3.0	6	4	16	55	2.85
G8A600300308	R0.3	3.0	6	4	8	55	2.85
G8A60919	R0.3	3.0	6	4	10	55	2.85
G8A600300312	R0.3	3.0	6	4	12	55	2.85
G8A600300316	R0.3	3.0	6	4	16	55	2.85
G8A60030	R0.5	3.0	6	4	10	55	2.85
G8A600300512	R0.5	3.0	6	4	12	55	2.85
G8A60901	R0.5	3.0	6	4	16	55	2.85
G8A60902	R0.5	3.0	6	4	20	55	2.85
G8A600400212	R0.2	4.0	6	5	12	55	3.85
G8A600400216	R0.2	4.0	6	5	16	55	3.85
G8A600400220	R0.2	4.0	6	5	20	55	3.85
G8A600400310	R0.3	4.0	6	5	10	55	3.85
G8A60920	R0.3	4.0	6	5	12	55	3.85
G8A600400316	R0.3	4.0	6	5	16	55	3.85
G8A600400320	R0.3	4.0	6	5	20	55	3.85
G8A60040	R0.5	4.0	6	5	12	55	3.85
G8A60903	R0.5	4.0	6	5	16	55	3.85

Due to the characteristics of the blue decoration layer, it might be erased during short term use and the color layer might not be uniformed. However, it doesn't affect the performance of the tool.

▶ NEXT PAGE

Size	Corner Radius Tolerance (mm)	Mill Dia. Tolerance (mm)	Shank Dia. Tolerance
up to Ø6	± 0.010	0 ~ - 0.012	h5
over Ø6	± 0.015	0 ~ - 0.015	

◎ : Excellent ○ : Good

ISO Material Description	P										M				K						
	Non-alloy steel					Low alloy steel					High alloyed steel, and tool steel				Stainless steel		Grey cast iron		Nodular cast iron		Malleable cast iron
VDI 3323	1	2	3	4	5	6	7	8	9	10	11	12	13	14	15	16	17	18	19	20	
HRC		13	25	28	32	10	29	32	38	15	35	15	23	10	10	26	3	25	42	21	
HB	125	190	250	270	300	180	275	300	350	200	325	200	240	180	180	260	160	250	130	230	
Recommend					○				○	○				○							

ISO Material Description	N					S					H										
	Aluminum-wrought alloy		Aluminum-cast, alloyed		Copper and Copper Alloys (Bronze / Brass)	Non Metallic Materials	Heat Resistant Super Alloys			Titanium Alloys		Hardened steel	Chilled Cast Iron	Hardened Cast Iron							
VDI 3323	21	22	23	24	25	26	27	28	29	30	31	32	33	34	35	36	37	38	39	40	41
HRC											15	30	25	38	34			55	60	42	55
HB	60	100	75	90	130	110	90	100			200	280	250	350	320	400 Rm	1050 Rm	550	630	400	550
Recommend																		◎	◎	○	◎



CARBIDE, 2 FLUTE CORNER RADIUS for RIB PROCESSING

- **VOLLHARTMETALL, 2 SCHNEIDEN ECKENRADIUS für SCHMALE RIPPEN**
- **Fraise carbure, 2 dents, torique pour usinage de rainure**
- **2 TAGLIENTI, TORICA, SCARICATA PER ENRVATURE**

- ▶ Designed to machine high hardened materials.
- ▶ Suitable for dry cutting, high speed cutting thanks to newly developed raw-material and new coating.
- ▶ Excellent workpiece finish.
- ▶ Deep slotting is possible by reduced neck.
- ▶ Corner radius for preventing the chipping in high speed machining.
- ▶ Higher wear-resistance.

- ▶ Geeignet zum Fräsen hochgehärteter Stähle.
- ▶ Geeignet zum Trockenfräsen und HSC-Fräsen dank neuentwickeltem Material und Beschichtung.
- ▶ Excellente Werkstückoberflächen.
- ▶ Abgesetzter Schaft für größere Reichweite.
- ▶ Schneidkantenschutz durch definierten Radius.
- ▶ Höhere Verschleißfestigkeit.

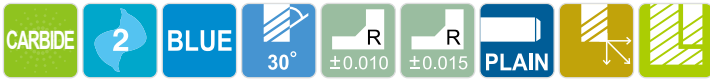
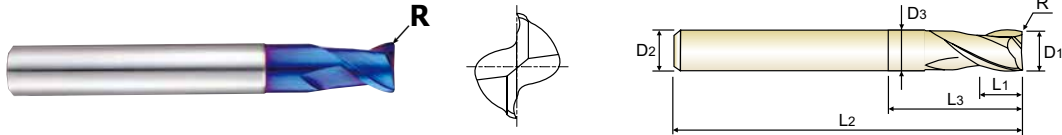

P.146-147

Ø0.5-Ø6 Ø8-Ø12

Unit : mm

EDP No.	Corner Radius	Mill Diameter	Shank Diameter	Length of Cut	Length Below Shank	Overall Length	Neck Diameter
	R	D1	D2	L1	L3	L2	D3
G8A60904	R0.5	4.0	6	5	20	55	3.85
G8A600401012	R1.0	4.0	6	5	12	55	3.85
G8A600401016	R1.0	4.0	6	5	16	55	3.85
G8A60921	R0.3	6.0	6	7	20	60	5.85
G8A60060	R0.5	6.0	6	7	20	60	5.85
G8A60905	R1.0	6.0	6	7	20	60	5.85
G8A60906	R1.5	6.0	6	7	20	60	5.85
G8A600602020	R2.0	6.0	6	7	20	60	5.85
G8A60922	R0.3	8.0	8	9	25	60	7.7
G8A60929	R0.5	8.0	8	9	25	60	7.7
G8A60080	R1.0	8.0	8	9	25	60	7.7
G8A60907	R1.5	8.0	8	9	25	60	7.7
G8A600802025	R2.0	8.0	8	9	25	60	7.7
G8A60923	R0.3	10.0	10	11	32	70	9.7
G8A601000532	R0.5	10.0	10	11	32	70	9.7
G8A60100	R1.0	10.0	10	11	32	70	9.7
G8A60908	R1.5	10.0	10	11	32	70	9.7
G8A601002032	R2.0	10.0	10	11	32	70	9.7
G8A601200538	R0.5	12.0	12	12	38	80	11.7
G8A60120	R1.0	12.0	12	12	38	80	11.7
G8A60909	R1.5	12.0	12	12	38	80	11.7
G8A601202038	R2.0	12.0	12	12	38	80	11.7

Due to the characteristics of the blue decoration layer, it might be erased during short term use and the color layer might not be uniformed. However, it doesn't affect the performance of the tool.

Size	Corner Radius Tolerance (mm)	Mill Dia. Tolerance (mm)	Shank Dia. Tolerance
up to Ø6	± 0.010	0 ~ - 0.012	h5
over Ø6	± 0.015	0 ~ - 0.015	

◎ : Excellent ○ : Good

ISO Material Description	P											M				K					
	Non-alloy steel					Low alloy steel				High alloyed steel, and tool steel		Stainless steel				Grey cast iron		Nodular cast iron		Malleable cast iron	
VDI 3323	1	2	3	4	5	6	7	8	9	10	11	12	13	14	15	16	17	18	19	20	
HRc	13	25	28	32	10	29	32	38	15	35	15	23	10	10	26	3	25		21		
HB	125	190	250	270	300	180	275	300	350	200	325	200	240	180	180	260	160	250	130	230	
Recommend					○				○		○										
ISO Material Description	N										S							H			
	Aluminum-wrought alloy		Aluminum-cast, alloyed			Copper and Copper Alloys (Bronze / Brass)			Non Metallic Materials		Heat Resistant Super Alloys					Titanium Alloys		Hardened steel	Chilled Cast Iron	Hardened Cast Iron	
VDI 3323	21	22	23	24	25	26	27	28	29	30	31	32	33	34	35	36	37	38	39	40	41
HRc											15	30	25	38	34			55	60	42	55
HB	60	100	75	90	130	110	90	100			200	280	250	350	320	400 Rm	1050 Rm	550	630	400	550
Recommend																		◎	◎	○	◎

CARBIDE, 2 FLUTE STUB LENGTH CORNER RADIUS with EXTENDED NECK

● **VOLLHARTMETALL, 2 SCHNEIDEN EXTRA KURZ ECKENRADIUS mit ABGESETZTEM SCHAFTTEIL**
 (●) **Fraise carbure, 2 dents, torique, détalonnée, extra-courte**
 (●) **2 TAGLIENTI, TORICA, TAGLIENTE CORTO CON SARICO ESTESO**

- ▶ Designed to machine high hardened materials.
- ▶ Suitable for dry cutting, high speed cutting thanks to newly developed raw-material and new coating.
- ▶ Excellent workpiece finish.
- ▶ Deep slotting is possible by reduced neck.
- ▶ Corner radius for preventing the chipping in high speed machining.
- ▶ Higher wear-resistance.

- ▶ Geeignet zum Fräsen hochgehärteter Stähle.
- ▶ Geeignet zum Trockenfräsen und HSC-Fräsen dank neuentwickeltem Material und Beschichtung.
- ▶ Excellente Werkstückoberflächen.
- ▶ Abgesetzter Schaft für größere Reichweite.
- ▶ Schneidkantenschutz durch definierten Radius.
- ▶ Höhere Verschleißfestigkeit.

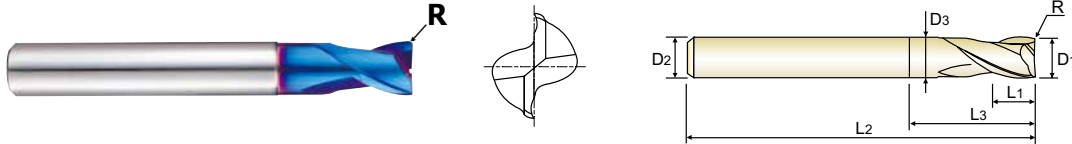

CARBIDE 2 BLUE 30° ±0.010 ±0.015 PLAIN P.153-155

Ø0.3-Ø6 Ø8-Ø20 Unit : mm

EDP No.	Corner Radius	Mill Diameter	Shank Diameter	Length of Cut	Length Below Shank	Overall Length	Neck Diameter
	R	D1	D2	L1	L3	L2	D3
G8A36003	-	0.3	3	0.45	-	40	-
G8A36004	-	0.4	3	0.6	-	40	-
G8A36005	R0.05	0.5	3	0.7	-	40	-
G8A36907	R0.05	0.5	4	1	-	40	-
G8A36006	R0.05	0.6	3	0.9	-	40	-
G8A36908	R0.05	0.6	4	1.2	-	40	-
G8A36909	R0.05	0.7	4	1.4	-	40	-
G8A36008	R0.05	0.8	3	1.2	-	40	-
G8A36910	R0.05	0.8	4	1.6	-	40	-
G8A36911	R0.05	0.9	4	2	-	40	-
G8A36010	R0.1	1.0	3	1.5	-	40	-
G8A36901	R0.1	1.0	4	1.5	-	40	-
G8A36903	R0.1	1.0	6	1.5	-	40	-
G8A36015	R0.1	1.5	3	2.2	-	40	-
G8A36904	R0.1	1.5	6	2.2	-	40	-
G8A36020	R0.1	2.0	3	3	6	40	1.95
G8A36902	R0.1	2.0	4	3	6	40	1.95
G8A36905	R0.1	2.0	6	3	6	40	1.95
G8A36025	R0.1	2.5	3	4	6	40	2.4
G8A36906	R0.1	2.5	6	4	6	40	2.4
G8A36030	R0.1	3.0	6	4	7	45	2.85
G8A36035	R0.1	3.5	6	5	9	45	3.35

Due to the characteristics of the blue decoration layer, it might be erased during short term use and the color layer might not be uniformed. However, it doesn't affect the performance of the tool. ▶ NEXT PAGE

Size	Corner Radius Tolerance (mm)	Mill Dia. Tolerance (mm)	Shank Dia. Tolerance
up to Ø6	± 0.010	0 ~ - 0.012	h5
over Ø6	± 0.015	0 ~ - 0.015	

◎ : Excellent ○ : Good

ISO Material Description	P										M				K						
	Non-alloy steel					Low alloy steel					High alloyed steel, and tool steel				Stainless steel		Grey cast iron		Nodular cast iron		Malleable cast iron
VDI 3323	1	2	3	4	5	6	7	8	9	10	11	12	13	14	15	16	17	18	19	20	
HRC		13	25	28	32	10	29	32	38	15	35	15	23	10	10	26	3	25	42	21	
HB	125	190	250	270	300	180	275	300	350	200	325	200	240	180	180	260	160	250	130	230	
Recommend					○				○	○	○										
ISO Material Description	N										S						H				
	Aluminum-wrought alloy		Aluminum-cast, alloyed			Copper and Copper Alloys (Bronze / Brass)			Non Metallic Materials		Heat Resistant Super Alloys						Titanium Alloys		Hardened steel	Chilled Cast Iron	Hardened Cast Iron
VDI 3323	21	22	23	24	25	26	27	28	29	30	31	32	33	34	35	36	37	38	39	40	41
HRC											15	30	25	38	34			55	60	42	55
HB	60	100	75	90	130	110	90	100			200	280	250	350	320	400 Rm	1050 Rm	550	630	400	550
Recommend																		◎	◎	○	◎



CARBIDE, 2 FLUTE STUB LENGTH CORNER RADIUS with EXTENDED NECK

- **VOLLHARTMETALL, 2 SCHNEIDEN EXTRA KURZ ECKENRADIUS mit ABGESETZTEM SCHAFTTEIL**
- **Fraise carbure, 2 dents, torique, détalonnée, extra-courte**
- **2 TAGLIENTI, TORICA, TAGLIENTE CORTO CON SARICO ESTESO**

- ▶ Designed to machine high hardened materials.
- ▶ Suitable for dry cutting, high speed cutting thanks to newly developed raw-material and new coating.
- ▶ Excellent workpiece finish.
- ▶ Deep slotting is possible by reduced neck.
- ▶ Corner radius for preventing the chipping in high speed machining.
- ▶ Higher wear-resistance.

- ▶ Geeignet zum Fräsen hochgehärteter Stähle.
- ▶ Geeignet zum Trockenfräsen und HSC-Fräsen dank neuentwickeltem Material und Beschichtung.
- ▶ Excellente Werkstückoberflächen.
- ▶ Abgesetzter Schaft für größere Reichweite.
- ▶ Schneidkantenschutz durch definierten Radius.
- ▶ Höhere Verschleißfestigkeit.

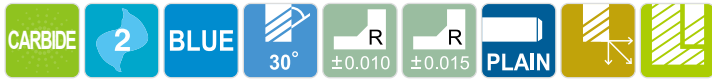
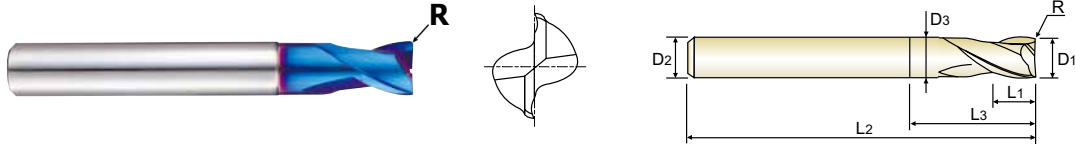

P.153-155

Ø0.3-Ø6 Ø8-Ø20

Unit : mm

EDP No.	Corner Radius	Mill Diameter	Shank Diameter	Length of Cut	Length Below Shank	Overall Length	Neck Diameter
	R	D1	D2	L1	L3	L2	D3
G8A36040	R0.1	4.0	6	5	9	45	3.85
G8A36045	R0.1	4.5	6	6	10	45	4.35
G8A36050	R0.2	5.0	6	6	11	50	4.85
G8A36060	R0.2	6.0	6	7	14	50	5.85
G8A36080	R0.2	8.0	8	9	18	60	7.7
G8A36100	R0.2	10.0	10	12	25	75	9.7
G8A36120	R0.3	12.0	12	15	30	75	11.7
G8A36160	R0.3	16.0	16	18	38	90	15.7
G8A36200	R0.3	20.0	20	24	45	100	19.7

Due to the characteristics of the blue decoration layer, it might be erased during short term use and the color layer might not be uniformed. However, it doesn't affect the performance of the tool.

Size	Corner Radius Tolerance (mm)	Mill Dia. Tolerance (mm)	Shank Dia. Tolerance
up to Ø6	± 0.010	0 ~ - 0.012	h5
over Ø6	± 0.015	0 ~ - 0.015	

◎ : Excellent ○ : Good

ISO Material Description	P											M			K						
	Non-alloy steel					Low alloy steel				High alloyed steel, and tool steel		Stainless steel			Grey cast iron		Nodular cast iron		Malleable cast iron		
VDI 3323	1	2	3	4	5	6	7	8	9	10	11	12	13	14	15	16	17	18	19	20	
HRc	13	25	28	32	10	29	32	38	15	35	15	23	10	10	26	3	25	42	55		
HB	125	190	250	270	300	180	275	300	350	200	325	200	240	180	180	260	160	250	130	230	
Recommend					○			○	○		○										
ISO Material Description	N										S							H			
	Aluminum-wrought alloy		Aluminum-cast, alloyed			Copper and Copper Alloys (Bronze / Brass)			Non Metallic Materials		Heat Resistant Super Alloys					Titanium Alloys		Hardened steel	Chilled Cast Iron	Hardened Cast Iron	
VDI 3323	21	22	23	24	25	26	27	28	29	30	31	32	33	34	35	36	37	38	39	40	41
HRc											15	30	25	38	34			55	60	42	55
HB	60	100	75	90	130	110	90	100			200	280	250	350	320	400 Rm	1050 Rm	550	630	400	550
Recommend																		◎	◎	○	◎

CARBIDE, 2 FLUTE CORNER RADIUS for RIB PROCESSING

- VOLLHARTMETALL, 2 SCHNEIDEN ECKENRADIUS für SCHMALE RIPPEN
- Fraise carbure, 2 dents, torique pour usinage de rainure
- 2 TAGLIANTI, TORICA, SCARIATA PER NERVATURE

- ▶ Designed to machine high hardened materials.
- ▶ Suitable for dry cutting, high speed cutting thanks to newly developed raw-material and new coating.
- ▶ Excellent workpiece finish.
- ▶ Deep slotting is possible by reduced neck.
- ▶ Corner radius for preventing the chipping in high speed machining.
- ▶ Higher wear-resistance.

- ▶ Geeignet zum Fräsen hochgehärteter Stähle.
- ▶ Geeignet zum Trockenfräsen und HSC-Fräsen dank neuentwickeltem Material und Beschichtung.
- ▶ Excellente Werkstückoberflächen.
- ▶ Abgesetzter Schaft für größere Reichweite.
- ▶ Schneidkantenschutz durch definierten Radius.
- ▶ Höhere Verschleißfestigkeit.

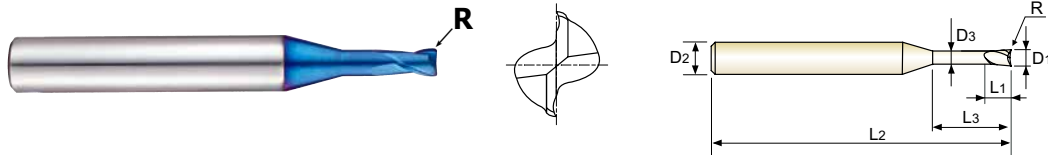

CARBIDE 2 BLUE 30° ±0.010 PLAIN P.148

Unit : mm

EDP No.	Corner Radius	Mill Diameter	Shank Diameter	Length of Cut	Length Below Shank	Overall Length	Neck Diameter
	R (±0.010)	D1	D2	L1	L3	L2	D3
G8A52005	R0.05	0.5	6	0.7	1.5	50	0.45
G8A52901	R0.05	0.5	6	0.7	3.3	50	0.45
G8A52006	R0.05	0.6	6	0.9	2	50	0.55
G8A52902	R0.05	0.6	6	0.9	4	50	0.55
G8A52008	R0.05	0.8	6	1.2	2.5	50	0.75
G8A52903	R0.05	0.8	6	1.2	5.5	50	0.75
G8A52010	R0.10	1.0	6	1.5	3.3	50	0.95
G8A52904	R0.10	1.0	6	1.5	6.7	50	0.95
G8A52012	R0.10	1.2	6	1.8	4.4	50	1.15
G8A52905	R0.10	1.2	6	1.8	8	50	1.15
G8A52015	R0.15	1.5	6	2.2	5	50	1.45
G8A52906	R0.15	1.5	6	2.2	9.7	50	1.45
G8A52020	R0.15	2.0	6	2.2	6	50	1.95
G8A52907	R0.15	2.0	6	2.2	13	50	1.95

Due to the characteristics of the blue decoration layer, it might be erased during short term use and the color layer might not be uniformed. However, it doesn't affect the performance of the tool.

Mill Dia. Tolerance (mm)	Shank Dia. Tolerance
0 ~ - 0.012	h5

◎ : Excellent ○ : Good

ISO Material Description	P									M					K						
	Non-alloy steel				Low alloy steel					High alloyed steel, and tool steel					Stainless steel			Grey cast iron		Nodular cast iron	
VDI 3323	1	2	3	4	5	6	7	8	9	10	11	12	13	14	15	16	17	18	19	20	
HRC																					
HB	125	190	250	270	300	180	275	300	350	200	325	200	240	180	180	260	160	250	130	230	
Recommend					○				○		○										
ISO Material Description	N									S							H				
	Aluminum-wrought alloy		Aluminum-cast, alloyed			Copper and Copper Alloys (Bronze / Brass)				Non Metallic Materials		Heat Resistant Super Alloys					Titanium Alloys		Hardened steel	Chilled Cast Iron	Hardened Cast Iron
VDI 3323	21	22	23	24	25	26	27	28	29	30	31	32	33	34	35	36	37	38	39	40	41
HRC																					
HB	60	100	75	90	130	110	90	100			200	280	250	350	320	400 Rm	1050 Rm	550	630	400	550
Recommend																		◎	◎	○	◎

CARBIDE, 2 FLUTE MINIATURE CORNER RADIUS

- **VOLLHARTMETALL, 2 SCHNEIDEN MINI ECKENRADIUS**
- **Fraise carbure, 2 dents, torique, micro-fraise**
- **2 TAGLIENTI, TORICA MINI**

- ▶ Designed to machine high hardened materials.
 - ▶ Suitable for dry cutting, high speed cutting thanks to newly developed raw-material and new coating.
 - ▶ Excellent workpiece finish.
 - ▶ Deep slotting is possible by reduced neck.
 - ▶ Corner radius for preventing the chipping in high speed machining.
 - ▶ Higher wear-resistance.
- ▶ Geeignet zum Fräsen hochgehärteter Stähle.
 - ▶ Geeignet zum Trockenfräsen und HSC-Fräsen dank neuentwickeltem Material und Beschichtung.
 - ▶ Excellente Werkstückoberflächen.
 - ▶ Abgesetzter Schaft für größere Reichweite.
 - ▶ Schneidkantenschutz durch definierten Radius.
 - ▶ Höhere Verschleißfestigkeit.

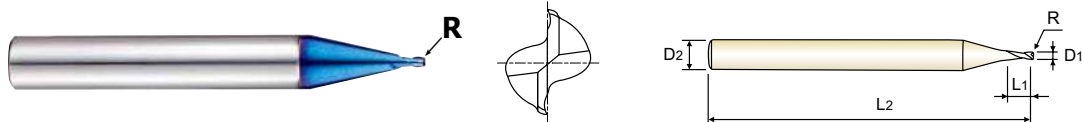

CARBIDE 2 BLUE 30° ±0.010 PLAIN P.149

EDP No.	Corner Radius	Mill Diameter	Shank Diameter	Length of Cut	Overall Length
	R	D1	D2	L1	L2
G8A50003	-	0.3	6	0.45	50
G8A50004	-	0.4	6	0.6	50
G8A50005	R0.05	0.5	6	0.7	50
G8A50006	R0.05	0.6	6	0.9	50
G8A50008	R0.05	0.8	6	1.2	50
G8A50010	R0.10	1.0	6	1.5	50
G8A50012	R0.10	1.2	6	1.8	50
G8A50015	R0.15	1.5	6	2.2	50
G8A50020	R0.15	2.0	6	2.2	50

Due to the characteristics of the blue decoration layer, it might be erased during short term use and the color layer might not be uniformed. However, it doesn't affect the performance of the tool.

Mill Dia. Tolerance (mm)	Shank Dia. Tolerance
0 ~ - 0.012	h5

◎ : Excellent ○ : Good

ISO Material Description	P											M			K						
	Non-alloy steel					Low alloy steel						High alloyed steel, and tool steel			Stainless steel			Grey cast iron		Nodular cast iron	
VDI 3323	1	2	3	4	5	6	7	8	9	10	11	12	13	14	15	16	17	18	19	20	
HRc	13	25	28	32	30	10	29	32	38	15	35	15	23	10	10	26	3	25	42	55	
HB	125	190	250	270	300	180	275	300	350	200	325	200	240	180	180	260	160	250	130	230	
Recommend					○				○	○	○										
ISO Material Description	S										H										
	Aluminum-wrought alloy		Aluminum-cast, alloyed			Copper and Copper Alloys (Bronze / Brass)		Non Metallic Materials			Heat Resistant Super Alloys					Titanium Alloys		Hardened steel	Chilled Cast Iron	Hardened Cast Iron	
VDI 3323	21	22	23	24	25	26	27	28	29	30	31	32	33	34	35	36	37	38	39	40	41
HRc											15	30	25	38	34			55	60	42	55
HB	60	100	75	90	130	110	90	100			200	280	250	350	320	400 Rm	1050 Rm	550	630	400	550
Recommend																		◎	◎	○	◎

CARBIDE, 4 FLUTE CORNER RADIUS with EXTENDED NECK

- VOLLHARTMETALL, 4 SCHNEIDEN ECKENRADIUS mit ABGESETZTEM SCHAFTTEIL
- Fraise carbure, 2 dents, torique, micro-fraise
- 4 TAGLIANTI, TORICA

- ▶ Designed to machine high hardened materials.
- ▶ Suitable for dry cutting, high speed cutting thanks to newly developed raw-material and new coating.
- ▶ Excellent workpiece finish.
- ▶ Deep slotting is possible by reduced neck.
- ▶ Corner radius for preventing the chipping in high speed machining.
- ▶ Higher wear-resistance.

- ▶ Geeignet zum Fräsen hochgehärteter Stähle.
- ▶ Geeignet zum Trockenfräsen und HSC-Fräsen dank neuentwickeltem Material und Beschichtung.
- ▶ Excellente Werkstückoberflächen.
- ▶ Abgesetzter Schaft für größere Reichweite.
- ▶ Schneidkantenschutz durch definierten Radius.
- ▶ Höhere Verschleißfestigkeit.

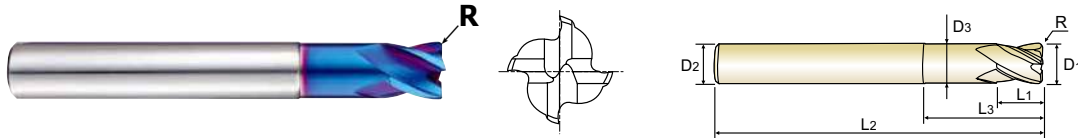

CARBIDE 4 BLUE 30° ±0.010 ±0.015 PLAIN P.150

Ø3-Ø6 Ø8-Ø12

Unit : mm

EDP No.	Corner Radius	Mill Diameter	Shank Diameter	Length of Cut	Length Below Shank	Overall Length	Neck Diameter
	R (±0.010)	D1	D2	L1	L3	L2	D3
G8A47916	R0.3	3.0	6	4	12	55	2.85
G8A47917	R0.3	3.0	6	4	16	55	2.85
G8A47918	R0.3	3.0	6	4	20	55	2.85
G8A47030	R0.5	3.0	6	4	10	55	2.85
G8A47901	R0.5	3.0	6	4	16	55	2.85
G8A47902	R0.5	3.0	6	4	20	55	2.85
G8A47919	R0.3	4.0	6	5	12	55	3.85
G8A47920	R0.3	4.0	6	5	16	55	3.85
G8A47921	R0.3	4.0	6	5	20	55	3.85
G8A47040	R0.5	4.0	6	5	12	55	3.85
G8A47903	R0.5	4.0	6	5	16	55	3.85
G8A47904	R0.5	4.0	6	5	20	55	3.85
G8A47922	R1.0	4.0	6	5	12	55	3.85
G8A47060	R0.5	6.0	6	7	20	60	5.85
G8A47905	R1.0	6.0	6	7	20	60	5.85
G8A47906	R1.5	6.0	6	7	20	60	5.85
G8A47910	R0.5	8.0	8	9	25	60	7.7
G8A47080	R1.0	8.0	8	9	25	60	7.7
G8A47907	R1.5	8.0	8	9	25	60	7.7
G8A47913	R2.0	8.0	8	9	25	60	7.7
G8A47911	R0.5	10.0	10	11	32	70	9.7
G8A47100	R1.0	10.0	10	11	32	70	9.7
G8A47908	R1.5	10.0	10	11	32	70	9.7
G8A47914	R2.0	10.0	10	11	32	70	9.7
G8A47912	R0.5	12.0	12	12	38	80	11.7
G8A47120	R1.0	12.0	12	12	38	80	11.7
G8A47909	R1.5	12.0	12	12	38	80	11.7
G8A47915	R2.0	12.0	12	12	38	80	11.7

Due to the characteristics of the blue decoration layer, it might be erased during short term use and the color layer might not be uniformed. However, it doesn't affect the performance of the tool.

Size	Corner Radius Tolerance (mm)	Mill Dia. Tolerance (mm)	Shank Dia. Tolerance
up to Ø6	± 0.010	0 ~ - 0.012	h5
over Ø6	± 0.015	0 ~ - 0.015	

◎ : Excellent ○ : Good

ISO Material Description	P									M					K					
	Non-alloy steel					Low alloy steel				High alloyed steel, and tool steel	Stainless steel				Grey cast iron		Nodular cast iron		Malleable cast iron	
VDI 3323	1	2	3	4	5	6	7	8	9	10	11	12	13	14	15	16	17	18	19	20
HRC																				
HB	125	190	250	270	300	180	275	300	350	200	325	200	240	180	180	260	160	250	130	230
Recommend					○				○	○										

ISO Material Description	N					S										H					
	Aluminum-wrought alloy		Aluminum-cast, alloyed		Copper and Copper Alloys (Bronze / Brass)	Non Metallic Materials	Heat Resistant Super Alloys					Titanium Alloys		Hardened steel	Chilled Cast Iron	Hardened Cast Iron					
VDI 3323	21	22	23	24	25	26	27	28	29	30	31	32	33	34	35	36	37	38	39	40	41
HRC																					
HB	60	100	75	90	130	110	90	100			200	280	250	350	320	400 Rm	1050 Rm	550	630	400	550
Recommend																		◎	◎	○	◎

YG X5070 END MILLS

PLAIN SHANK

G8A37 SERIES

CARBIDE, 4 FLUTE STUB LENGTH CORNER RADIUS with EXTENDED NECK

- **VOLLHARTMETALL, 4 SCHNEIDEN EXTRA KURZ ECKENRADIUS mit ABGESETZTEM SCHAFTTEIL**
- **Fraise carbure, 4 dents, torique, détalonnée, extra-courte**
- **4 TAGLIENTI, TORICA, TAGLIENTE CORTO CON SCARICO ESTESO**

- ▶ Designed to machine high hardened materials.
- ▶ Suitable for dry cutting, high speed cutting thanks to newly developed raw-material and new coating.
- ▶ Excellent workpiece finish.
- ▶ Deep slotting is possible by reduced neck.
- ▶ Corner radius for preventing the chipping in high speed machining.
- ▶ Higher wear-resistance.

- ▶ Geeignet zum Fräsen hochgehärteter Stähle.
- ▶ Geeignet zum Trockenfräsen und HSC-Fräsen dank neuentwickeltem Material und Beschichtung.
- ▶ Excellente Werkstückoberflächen.
- ▶ Abgesetzter Schaft für größere Reichweite.
- ▶ Schneidkantenschutz durch definierten Radius.
- ▶ Höhere Verschleißfestigkeit.

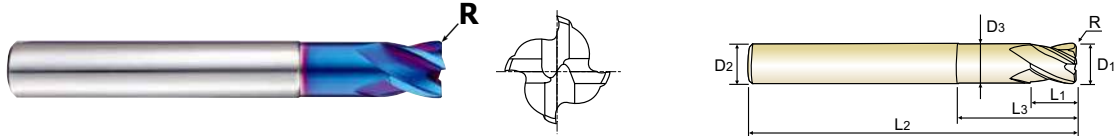

CARBIDE
4
BLUE
30°
R ±0.010
R ±0.015
PLAIN
P.156

EDP No.	Corner Radius	Mill Diameter	Shank Diameter	Length of Cut	Length Below Shank	Overall Length	Neck Diameter
	R (±0.010)	D1	D2	L1	L3	L2	D3
G8A37010	R0.1	1.0	3	1.5	-	40	-
G8A37901	R0.1	1.0	6	1.5	-	40	-
G8A37015	R0.1	1.5	3	2.2	-	40	-
G8A37902	R0.1	1.5	6	2.2	-	40	-
G8A37020	R0.1	2.0	3	3	6	40	1.95
G8A37903	R0.1	2.0	6	3	6	40	1.95
G8A37025	R0.1	2.5	3	4	6	40	2.4
G8A37904	R0.1	2.5	6	4	6	40	2.4
G8A37030	R0.1	3.0	6	4	7	45	2.85
G8A37035	R0.1	3.5	6	5	9	45	3.35
G8A37040	R0.1	4.0	6	5	9	45	3.85
G8A37045	R0.1	4.5	6	6	10	45	4.35
G8A37050	R0.2	5.0	6	6	11	50	4.85
G8A37060	R0.2	6.0	6	7	14	50	5.85
G8A37080	R0.2	8.0	8	9	18	60	7.7
G8A37100	R0.2	10.0	10	12	25	75	9.7
G8A37120	R0.3	12.0	12	15	30	75	11.7
G8A37160	R0.3	16.0	16	18	38	90	15.7
G8A37200	R0.3	20.0	20	24	45	100	19.7

Due to the characteristics of the blue decoration layer, it might be erased during short term use and the color layer might not be uniformed. However, it doesn't affect the performance of the tool.

Size	Corner Radius Tolerance (mm)	Mill Dia. Tolerance (mm)	Shank Dia. Tolerance
up to Ø6	± 0.010	0 ~ - 0.012	h5
over Ø6	± 0.015	0 ~ - 0.015	

◎ : Excellent ○ : Good

ISO Material Description	P											M			K						
	Non-alloy steel					Low alloy steel				High alloyed steel, and tool steel		Stainless steel			Grey cast iron		Nodular cast iron		Malleable cast iron		
VDI 3323	1	2	3	4	5	6	7	8	9	10	11	12	13	14	15	16	17	18	19	20	
HRc	13	25	28	32	10	29	32	38	15	35	15	23	10	10	26	3	25	42	55		
HB	125	190	250	270	300	180	275	300	350	200	325	200	240	180	180	260	160	250	130	230	
Recommend					○				○		○										
ISO Material Description	N										S						H				
	Aluminum-wrought alloy		Aluminum-cast, alloyed			Copper and Copper Alloys (Bronze / Brass)			Non Metallic Materials		Heat Resistant Super Alloys						Titanium Alloys		Hardened steel	Chilled Cast Iron	Hardened Cast Iron
VDI 3323	21	22	23	24	25	26	27	28	29	30	31	32	33	34	35	36	37	38	39	40	41
HRc											15	30	25	38	34			55	60	42	55
HB	60	100	75	90	130	110	90	100			200	280	250	350	320	400 Rm	1050 Rm	550	630	400	550
Recommend																		◎	◎	○	◎

CARBIDE, 4 FLUTE CORNER RADIUS with EXTENDED NECK

- VOLLHARTMETALL, 4 SCHNEIDEN ECKENRADIUS mit ABGESETZTEM SCHAFTTETL
- () Fraise carbure, 4 dents, torique, détalonnée
- () 4 TAGLIENTI, TORICA, TAGLIENTE CORTO CON SCARICO ESTESO

- ▶ Designed to machine high hardened materials.
- ▶ Suitable for dry cutting, high speed cutting thanks to newly developed raw-material and new coating.
- ▶ Excellent workpiece finish.
- ▶ Deep slotting is possible by reduced neck.
- ▶ Corner radius for preventing the chipping in high speed machining.
- ▶ Higher wear-resistance.

- ▶ Geeignet zum Fräsen hochgehärteter Stähle.
- ▶ Geeignet zum Trockenfräsen und HSC-Fräsen dank neuentwickeltem Material und Beschichtung.
- ▶ Excellente Werkstückoberflächen.
- ▶ Abgesetzter Schaft für größere Reichweite.
- ▶ Schneidkantenschutz durch definierten Radius.
- ▶ Höhere Verschleißfestigkeit.

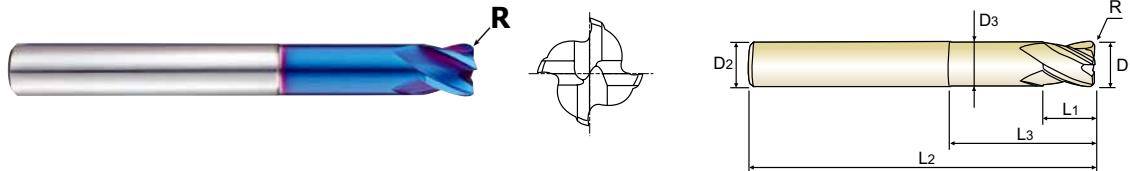

CARBIDE
4
BLUE
30°
R ±0.010
R ±0.015
PLAIN
P.150

Unit: mm

EDP No.	Corner Radius	Mill Diameter	Shank Diameter	Length of Cut	Length Below Shank	Overall Length	Neck Diameter
	R (±0.010)	D1	D2	L1	L3	L2	D3
G8B0806005090	R0.5	6.0	6	9	20	90	5.85
G8B0806010090	R1.0	6.0	6	9	20	90	5.85
G8B0808005100	R0.5	8.0	8	12	25	100	7.7
G8B0808010100	R1.0	8.0	8	12	25	100	7.7
G8B0810005100	R0.5	10.0	10	15	32	100	9.7
G8B0810010100	R1.0	10.0	10	15	32	100	9.7
G8B0810020100	R2.0	10.0	10	15	32	100	9.7
G8B0812005110	R0.5	12.0	12	18	38	110	11.7
G8B0812010110	R1.0	12.0	12	18	38	110	11.7
G8B0812020110	R2.0	12.0	12	18	38	110	11.7

Due to the characteristics of the blue decoration layer, it might be erased during short term use and the color layer might not be uniformed. However, it doesn't affect the performance of the tool.

Size	Corner Radius Tolerance (mm)	Mill Dia. Tolerance (mm)	Shank Dia. Tolerance
up to Ø6	± 0.010	0 ~ - 0.012	h5
over Ø6	± 0.015	0 ~ - 0.015	

◎: Excellent ○: Good

ISO	P										M			K							
	Non-alloy steel					Low alloy steel					High alloyed steel, and tool steel			Stainless steel			Grey cast iron		Nodular cast iron		Malleable cast iron
Material Description	1	2	3	4	5	6	7	8	9	10	11	12	13	14	15	16	17	18	19	20	
VDI 3323	1	2	3	4	5	6	7	8	9	10	11	12	13	14	15	16	17	18	19	20	
HRC																					
HB	125	190	250	270	300	180	275	300	350	200	325	200	240	180	180	260	160	250	130	230	
Recommend					○				○	○	○										

ISO	N					S					H										
	Aluminum-wrought alloy		Aluminum-cast, alloyed		Copper and Copper Alloys (Bronze / Brass)		Non Metallic Materials		Heat Resistant Super Alloys			Titanium Alloys		Hardened steel	Chilled Cast Iron	Hardened Cast Iron					
Material Description	21	22	23	24	25	26	27	28	29	30	31	32	33	34	35	36	37	38	39	40	41
VDI 3323	21	22	23	24	25	26	27	28	29	30	31	32	33	34	35	36	37	38	39	40	41
HRC																					
HB	60	100	75	90	130	110	90	100			200	280	250	350	320	400 Rm	1050 Rm	550	630	400	550
Recommend																		◎	◎	○	◎



CARBIDE, 6 FLUTE 45° HELIX CORNER RADIUS with EXTENDED NECK

VOLLHARTMETALL, 6 SCHNEIDEN 45° RECHTSSPIRALE ECKENRADIUS mit ABGESETZTEM SCHAFTTEIL
Fraise carbure, 6 dents, torique, hélice 45°, détalonnée
6 TAGLIENTI, TORICA, ELICA 45°, SCARICATA

- ▶ Designed to machine high hardened materials.
- ▶ Suitable for dry cutting, high speed cutting thanks to newly developed raw-material and new coating.
- ▶ Excellent workpiece finish.
- ▶ Deep slotting is possible by reduced neck.
- ▶ Corner radius for preventing the chipping in high speed machining.
- ▶ Higher wear-resistance.

- ▶ Geeignet zum Fräsen hochgehärteter Stähle.
- ▶ Geeignet zum Trockenfräsen und HSC-Fräsen dank neuentwickeltem Material und Beschichtung.
- ▶ Excellente Werkstückoberflächen.
- ▶ Abgesetzter Schaft für größere Reichweite.
- ▶ Schneidkantenschutz durch definierten Radius.
- ▶ Höhere Verschleißfestigkeit.

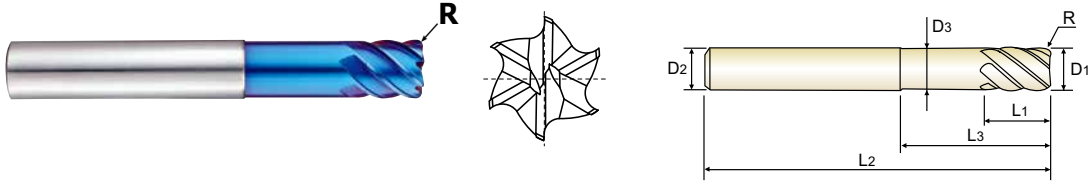

Ø6 Ø8-Ø20

Unit : mm

EDP No.	Corner Radius	Mill Diameter	Shank Diameter	Length of Cut	Length Below Shank	Overall Length	Neck Diameter
	R (±0.010)	D1	D2	L1	L3	L2	D3
G8A39916	R0.25	6.0	6	6	14	50	5.85
G8A39060	R0.5	6.0	6	6	14	50	5.85
G8A39901	R0.5	6.0	6	13	-	70	-
* G8A39910	R0.5	6.0	6	26	-	70	-
G8A39080	R0.5	8.0	8	8	24	60	7.7
G8A39902	R0.5	8.0	8	19	-	90	-
* G8A39911	R0.5	8.0	8	36	-	90	-
G8A39903	R0.5	10.0	10	22	-	100	-
G8A39100	R1.0	10.0	10	10	30	70	9.7
G8A39904	R1.0	10.0	10	22	-	100	-
* G8A39912	R1.0	10.0	10	46	-	100	-
G8A39905	R0.5	12.0	12	26	-	110	-
G8A39120	R1.0	12.0	12	12	30	75	11.7
G8A39906	R1.0	12.0	12	26	-	110	-
* G8A39913	R1.0	12.0	12	56	-	110	-
G8A39160	R1.0	16.0	16	32	-	130	-
G8A39907	R1.5	16.0	16	32	-	130	-
* G8A39914	R1.5	16.0	16	66	-	130	-
G8A39200	R1.0	20.0	20	38	-	140	-
G8A39908	R1.5	20.0	20	38	-	140	-
G8A39909	R2.0	20.0	20	38	-	140	-
* G8A39915	R2.0	20.0	20	76	-	140	-

Due to the characteristics of the blue decoration layer, it might be erased during short term use and the color layer might not be uniformed. However, it doesn't affect the performance of the tool.

Size	Corner Radius Tolerance (mm)	Mill Dia. Tolerance (mm)	Shank Dia. Tolerance
up to Ø6	± 0.010	0 ~ - 0.012	h5
over Ø6	± 0.015	0 ~ - 0.015	

* Mill Dia. Tolerance(mm) for Extra Long Type : 0~-0.03

◎ : Excellent ○ : Good

ISO Material Description	P									M						K					
	Non-alloy steel					Low alloy steel				High alloyed steel, and tool steel		Stainless steel				Grey cast iron		Nodular cast iron		Malleable cast iron	
VDI 3323	1	2	3	4	5	6	7	8	9	10	11	12	13	14	15	16	17	18	19	20	
HRc	13	25	28	32	10	29	32	38	15	35	15	23	10	10	26	3	25	42	55	21	
HB	125	190	250	270	300	180	275	300	350	200	325	200	240	180	180	260	160	250	130	230	
Recommend					○				○		○										
ISO Material Description	N					S				H											
	Aluminum-wrought alloy		Aluminum-cast, alloyed			Copper and Copper Alloys (Bronze / Brass)		Non Metallic Materials		Heat Resistant Super Alloys			Titanium Alloys		Hardened steel	Chilled Cast Iron	Hardened Cast Iron				
VDI 3323	21	22	23	24	25	26	27	28	29	30	31	32	33	34	35	36	37	38	39	40	41
HRc	60	100	75	90	130	110	90	100			15	30	25	38	34	400 Rm	1050 Rm	550	630	400	550
HB	60	100	75	90	130	110	90	100			200	280	250	350	320	400 Rm	1050 Rm	550	630	400	550
Recommend																		◎	◎	○	◎

CARBIDE, 2 FLUTE for RIB PROCESSING

- **VOLLHARTMETALL, 2 SCHNEIDEN für SCHMALE RIPPEN**
- **Fraise carbure, 2 dents pour usinage de rainure**
- **2 TAGLIANTI PER NERVATURE**

- ▶ Designed to machine high hardened materials.
- ▶ Suitable for dry cutting, high speed cutting thanks to newly developed raw-material and new coating.
- ▶ Excellent workpiece finish.
- ▶ Designed for high precision milling operation.
- ▶ Higher wear-resistance.

- ▶ Geeignet zum Fräsen hochgehärteter Stähle.
- ▶ Geeignet zum Trockenfräsen und HSC-Fräsen dank neuentwickeltem Material und Beschichtung.
- ▶ Excellente Werkstückoberflächen.
- ▶ Geeignet für hochpräzises Fräsen.
- ▶ Höhere Verschleißfestigkeit.

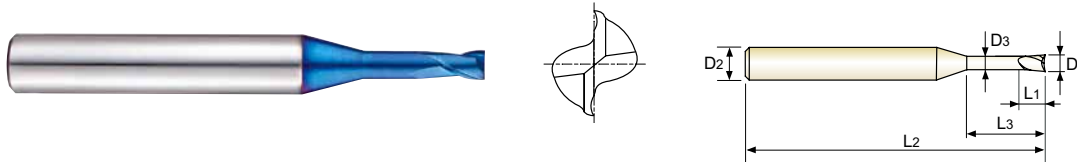

Unit : mm

EDP No.	Mill Diameter	Shank Diameter	Length of Cut	Length Below Shank	Overall Length	Neck Diameter
	D1	D2	L1	L3	L2	D3
G8A45863	0.1	4	0.15	0.3	45	0.085
G8A45864	0.1	4	0.15	0.5	45	0.085
G8A45002	0.2	4	0.3	0.5	45	0.17
G8A45815	0.2	4	0.3	1	45	0.17
G8A45816	0.2	4	0.3	1.5	45	0.17
G8A45003	0.3	4	0.45	1	45	0.27
G8A45844	0.3	4	0.45	1.5	45	0.27
G8A45817	0.3	4	0.45	2	45	0.27
G8A45818	0.3	4	0.45	3	45	0.27
G8A45842	0.3	4	0.45	4	45	0.27
G8A45843	0.4	4	0.6	1	45	0.37
G8A45004	0.4	4	0.6	2	45	0.37
G8A45984	0.4	4	0.6	3	45	0.37
G8A45985	0.4	4	0.6	4	45	0.37
G8A45986	0.4	4	0.6	5	45	0.37
G8A45005	0.5	4	0.7	2	45	0.45
G8A45861	0.5	4	0.7	2.5	45	0.45
G8A45988	0.5	4	0.7	4	45	0.45
G8A45989	0.5	4	0.7	6	45	0.45
G8A45990	0.5	4	0.7	8	45	0.45
G8A45006	0.6	4	0.9	2	45	0.55
G8A45860	0.6	4	0.9	3	45	0.55

Due to the characteristics of the blue decoration layer, it might be erased during short term use and the color layer might not be uniformed. However, it doesn't affect the performance of the tool. ▶ NEXT PAGE

Mill Dia. Tolerance (mm)	Shank Dia. Tolerance
0 ~ - 0.012	h5

◎ : Excellent ○ : Good

ISO Material Description	P										M				K						
	Non-alloy steel					Low alloy steel					High alloyed steel, and tool steel				Stainless steel		Grey cast iron		Nodular cast iron		Malleable cast iron
VDI 3323	1	2	3	4	5	6	7	8	9	10	11	12	13	14	15	16	17	18	19	20	
HRC		13	25	28	32	10	29	32	38	15	35	15	23	10	10	26	3	25	42	21	
HB	125	190	250	270	300	180	275	300	350	200	325	200	240	180	180	260	160	250	130	230	
Recommend					○				○		○										

ISO Material Description	N					S										H					
	Aluminum-wrought alloy		Aluminum-cast, alloyed			Copper and Copper Alloys (Bronze / Brass)			Non Metallic Materials		Heat Resistant Super Alloys					Titanium Alloys		Hardened steel	Chilled Cast Iron	Hardened Cast Iron	
VDI 3323	21	22	23	24	25	26	27	28	29	30	31	32	33	34	35	36	37	38	39	40	41
HRC											15	30	25	38	34			55	60	42	55
HB	60	100	75	90	130	110	90	100			200	280	250	350	320	400 Rm	1050 Rm	550	630	400	550
Recommend																		◎	◎	○	◎

CARBIDE, 2 FLUTE for RIB PROCESSING

- **VOLLHARTMETALL, 2 SCHNEIDEN für SCHMALE RIPPEN**
- **Fraise carbure, 2 dents pour usinage de rainure**
- **2 TAGLIENTI PER NERVATURE**

- ▶ Designed to machine high hardened materials.
- ▶ Suitable for dry cutting, high speed cutting thanks to newly developed raw-material and new coating.
- ▶ Excellent workpiece finish.
- ▶ Designed for high precision milling operation.
- ▶ Higher wear-resistance.

- ▶ Geeignet zum Fräsen hochgehärteter Stähle.
- ▶ Geeignet zum Trockenfräsen und HSC-Fräsen dank neuentwickeltem Material und Beschichtung.
- ▶ Excellente Werkstückoberflächen.
- ▶ Geeignet für hochpräzises Fräsen.
- ▶ Höhere Verschleißfestigkeit.

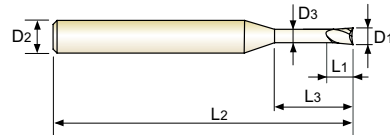
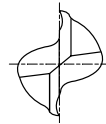

P,151~152

Unit : mm

EDP No.	Mill Diameter	Shank Diameter	Length of Cut	Length Below Shank	Overall Length	Neck Diameter
	D1	D2	L1	L3	L2	D3
G8A45991	0.6	4	0.9	4	45	0.55
G8A45992	0.6	4	0.9	6	45	0.55
G8A45993	0.6	4	0.9	8	45	0.55
G8A45819	0.6	4	0.9	10	45	0.55
G8A45862	0.8	4	1.2	2	45	0.75
G8A45008	0.8	4	1.2	4	45	0.75
G8A45908	0.8	4	1.2	6	45	0.75
G8A45909	0.8	4	1.2	8	45	0.75
G8A45994	0.8	4	1.2	10	45	0.75
G8A45995	0.8	4	1.2	12	45	0.75
G8A45996	1.0	4	1.5	4	45	0.95
G8A45010	1.0	4	1.5	6	45	0.95
G8A45912	1.0	4	1.5	8	45	0.95
G8A45913	1.0	4	1.5	10	45	0.95
G8A45914	1.0	4	1.5	12	45	0.95
G8A45997	1.0	4	1.5	16	50	0.95
G8A45998	1.0	4	1.5	20	55	0.95
G8A45012	1.2	4	1.8	6	45	1.15
G8A45915	1.2	4	1.8	8	45	1.15
G8A45916	1.2	4	1.8	10	45	1.15
G8A45917	1.2	4	1.8	12	45	1.15
G8A45999	1.2	4	1.8	16	50	1.15

Due to the characteristics of the blue decoration layer, it might be erased during short term use and the color layer might not be uniformed. However, it doesn't affect the performance of the tool. ▶ NEXT PAGE

Mill Dia. Tolerance (mm)	Shank Dia. Tolerance
0 ~ - 0.012	h5

◎ : Excellent ○ : Good

ISO Material Description	P											M			K						
	Non-alloy steel					Low alloy steel				High alloyed steel, and tool steel		Stainless steel			Grey cast iron		Nodular cast iron		Malleable cast iron		
VDI 3323	1	2	3	4	5	6	7	8	9	10	11	12	13	14	15	16	17	18	19	20	
HRc	13	25	28	32	10	29	32	38	15	35	15	23	10	10	26	3	25		21		
HB	125	190	250	270	300	180	275	300	350	200	325	200	240	180	180	260	160	250	130	230	
Recommend					○				○		○										
ISO Material Description	N										S							H			
	Aluminum-wrought alloy		Aluminum-cast, alloyed			Copper and Copper Alloys (Bronze / Brass)			Non Metallic Materials		Heat Resistant Super Alloys					Titanium Alloys		Hardened steel	Chilled Cast Iron	Hardened Cast Iron	
VDI 3323	21	22	23	24	25	26	27	28	29	30	31	32	33	34	35	36	37	38	39	40	41
HRc											15	30	25	38	34			55	60	42	55
HB	60	100	75	90	130	110	90	100			200	280	250	350	320	400 Rm	1050 Rm	550	630	400	550
Recommend																		◎	◎	○	◎



X5070 END MILLS

PLAIN SHANK

G8A45 SERIES

CARBIDE, 2 FLUTE for RIB PROCESSING

- VOLLHARTMETALL, 2 SCHNEIDEN für SCHMALE RIPPEN
- Fraise carbure, 2 dents pour usinage de rainure
- 2 TAGLIANTI PER NERVATURE

- ▶ Designed to machine high hardened materials.
- ▶ Suitable for dry cutting, high speed cutting thanks to newly developed raw-material and new coating.
- ▶ Excellent workpiece finish.
- ▶ Designed for high precision milling operation.
- ▶ Higher wear-resistance.

- ▶ Geeignet zum Fräsen hochgehärteter Stähle.
- ▶ Geeignet zum Trockenfräsen und HSC-Fräsen dank neuentwickeltem Material und Beschichtung.
- ▶ Excellente Werkstückoberflächen.
- ▶ Geeignet für hochpräzises Fräsen.
- ▶ Höhere Verschleißfestigkeit.

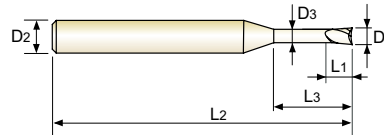
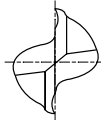

P,151~152

Unit : mm

EDP No.	Mill Diameter	Shank Diameter	Length of Cut	Length Below Shank	Overall Length	Neck Diameter
	D1	D2	L1	L3	L2	D3
G8A45015	1.5	4	2.3	6	45	1.45
G8A45923	1.5	4	2.3	8	45	1.45
G8A45924	1.5	4	2.3	10	45	1.45
G8A45925	1.5	4	2.3	12	45	1.45
G8A45926	1.5	4	2.3	14	50	1.45
G8A45927	1.5	4	2.3	16	50	1.45
G8A45928	1.5	4	2.3	18	55	1.45
G8A45810	1.5	4	2.3	20	55	1.45
G8A45958	2.0	4	3.0	6	45	1.95
G8A45020	2.0	4	3.0	8	45	1.95
G8A45959	2.0	4	3.0	10	45	1.95
G8A45960	2.0	4	3.0	12	45	1.95
G8A45961	2.0	4	3.0	14	50	1.95
G8A45962	2.0	4	3.0	16	50	1.95
G8A45963	2.0	4	3.0	18	55	1.95
G8A45964	2.0	4	3.0	20	55	1.95
G8A45966	2.0	4	3.0	25	60	1.95
G8A45814	2.0	4	3.0	30	70	1.95
G8A45975	3.0	6	4.5	10	45	2.85
G8A45976	3.0	6	4.5	12	45	2.85
G8A45977	3.0	6	4.5	14	50	2.85
G8A45978	3.0	6	4.5	16	55	2.85

Due to the characteristics of the blue decoration layer, it might be erased during short term use and the color layer might not be uniformed. However, it doesn't affect the performance of the tool.

▶ NEXT PAGE

Mill Dia. Tolerance (mm)	Shank Dia. Tolerance
0 ~ - 0.012	h5

◎ : Excellent ○ : Good

ISO Material Description	P										M				K						
	Non-alloy steel					Low alloy steel					High alloyed steel, and tool steel				Stainless steel		Grey cast iron		Nodular cast iron		Malleable cast iron
VDI 3323	1	2	3	4	5	6	7	8	9	10	11	12	13	14	15	16	17	18	19	20	
HRC																					
HB	125	190	250	270	300	180	275	300	350	200	325	200	240	180	180	260	160	250	130	230	
Recommend					○				○		○										

ISO Material Description	N					S										H					
	Aluminum-wrought alloy		Aluminum-cast, alloyed			Copper and Copper Alloys (Bronze / Brass)			Non Metallic Materials		Heat Resistant Super Alloys					Titanium Alloys		Hardened steel	Chilled Cast Iron	Hardened Cast Iron	
VDI 3323	21	22	23	24	25	26	27	28	29	30	31	32	33	34	35	36	37	38	39	40	41
HRC																					
HB	60	100	75	90	130	110	90	100			200	280	250	350	320	400 Rm	1050 Rm	550	630	400	550
Recommend																		◎	◎	○	◎



CARBIDE, 2 FLUTE for RIB PROCESSING

- **VOLLHARTMETALL, 2 SCHNEIDEN für SCHMALE RIPPEN**
- **Fraise carbure, 2 dents pour usinage de rainure**
- **2 TAGLIENTI PER NERVATURE**

- ▶ Designed to machine high hardened materials.
- ▶ Suitable for dry cutting, high speed cutting thanks to newly developed raw-material and new coating.
- ▶ Excellent workpiece finish.
- ▶ Designed for high precision milling operation.
- ▶ Higher wear-resistance.

- ▶ Geeignet zum Fräsen hochgehärteter Stähle.
- ▶ Geeignet zum Trockenfräsen und HSC-Fräsen dank neuentwickeltem Material und Beschichtung.
- ▶ Excellente Werkstückoberflächen.
- ▶ Geeignet für hochpräzises Fräsen.
- ▶ Höhere Verschleißfestigkeit.

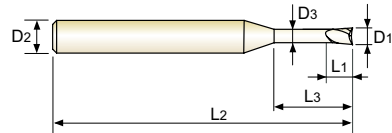
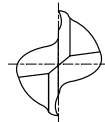

P,151~152

Unit : mm

EDP No.	Mill Diameter	Shank Diameter	Length of Cut	Length Below Shank	Overall Length	Neck Diameter
	D1	D2	L1	L3	L2	D3
G8A45979	3.0	6	4.5	18	55	2.85
G8A45980	3.0	6	4.5	20	60	2.85
G8A45981	3.0	6	4.5	25	65	2.85
G8A45832	3.0	6	4.5	30	70	2.85
G8A45833	3.0	6	4.5	35	80	2.85
G8A45983	3.0	6	4.5	40	90	2.85
G8A45040	4.0	6	6	12	50	3.85
G8A45801	4.0	6	6	16	60	3.85
G8A45802	4.0	6	6	20	60	3.85
G8A45803	4.0	6	6	25	70	3.85
G8A45834	4.0	6	6	30	70	3.85
G8A45835	4.0	6	6	35	80	3.85
G8A45836	4.0	6	6	40	90	3.85
G8A45837	4.0	6	6	45	90	3.85
G8A45838	4.0	6	6	50	100	3.85

Due to the characteristics of the blue decoration layer, it might be erased during short term use and the color layer might not be uniformed. However, it doesn't affect the performance of the tool.

Mill Dia. Tolerance (mm)	Shank Dia. Tolerance
0 ~ - 0.012	h5

◎ : Excellent ○ : Good

ISO Material Description	P											M			K						
	Non-alloy steel					Low alloy steel				High alloyed steel, and tool steel		Stainless steel			Grey cast iron		Nodular cast iron		Malleable cast iron		
VDI 3323	1	2	3	4	5	6	7	8	9	10	11	12	13	14	15	16	17	18	19	20	
HRc	13	25	28	32	10	29	32	38	15	35	15	23	10	10	26	3	25	42	55		
HB	125	190	250	270	300	180	275	300	350	200	325	200	240	180	180	260	160	250	130	230	
Recommend					○			○	○		○										
ISO Material Description	N										S							H			
	Aluminum-wrought alloy		Aluminum-cast, alloyed			Copper and Copper Alloys (Bronze / Brass)			Non Metallic Materials		Heat Resistant Super Alloys					Titanium Alloys		Hardened steel	Chilled Cast Iron	Hardened Cast Iron	
VDI 3323	21	22	23	24	25	26	27	28	29	30	31	32	33	34	35	36	37	38	39	40	41
HRc											15	30	25	38	34			55	60	42	55
HB	60	100	75	90	130	110	90	100			200	280	250	350	320	400 Rm	1050 Rm	550	630	400	550
Recommend																		◎	◎	○	◎



X5070 END MILLS

PLAIN SHANK

G8A01 SERIES

CARBIDE, 2 FLUTE with EXTENDED NECK

- VOLLHARTMETALL, 2 SCHNEIDEN mit ABGESETZTEM SCHAFTTEIL
- Fraise carbure, 2 dents, détalonnée
- 2 TAGLIANTI CON SCARICO ESTESO

- ▶ Designed to machine high hardened materials.
- ▶ Suitable for dry cutting, high speed cutting thanks to newly developed raw-material and new coating.
- ▶ Excellent workpiece finish.
- ▶ Designed for high precision milling operation.
- ▶ Higher wear-resistance.

- ▶ Geeignet zum Fräsen hochgehärteter Stähle.
- ▶ Geeignet zum Trockenfräsen und HSC-Fräsen dank neuentwickeltem Material und Beschichtung.
- ▶ Excellente Werkstückoberflächen.
- ▶ Geeignet für hochpräzises Fräsen.
- ▶ Höhere Verschleißfestigkeit.

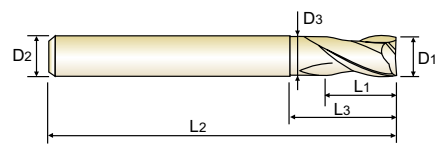
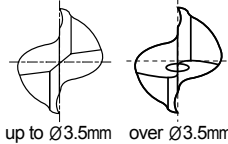

P.153-155

Unit : mm

EDP No.	Mill Diameter	Shank Diameter	Length of Cut	Length Below Shank	Overall Length	Neck Diameter
	D1	D2	L1	L3	L2	D3
G8A01001	0.1	4	0.2	-	40	-
G8A01002	0.2	4	0.4	-	40	-
G8A01003	0.3	4	0.6	-	40	-
G8A01004	0.4	4	0.8	-	40	-
G8A01005	0.5	4	1	-	40	-
G8A01006	0.6	4	1.2	-	40	-
G8A01007	0.7	4	1.4	-	40	-
G8A01008	0.8	4	1.6	-	40	-
G8A01009	0.9	4	2	-	40	-
G8A010104S	1.0	4	1.5	3	50	0.95
G8A01010	1.0	6	1.5	3	50	0.95
G8A010154S	1.5	4	1.7	4	50	1.45
G8A01015	1.5	6	1.7	4	50	1.45
G8A010204S	2.0	4	2	5	50	1.95
G8A01020	2.0	6	2	5	50	1.95
G8A010254S	2.5	4	2.5	6	55	2.4
G8A01025	2.5	6	2.5	6	55	2.4
G8A01030	3.0	6	3	8	55	2.85
G8A01035	3.5	6	3.5	9	55	3.35
G8A01040	4.0	6	4	10	55	3.85
G8A01050	5.0	6	5	13	55	4.85
G8A01060	6.0	6	6	15	55	5.85
G8A01080	8.0	8	8	20	65	7.7
G8A01100	10.0	10	10	25	75	9.7
G8A01120	12.0	12	12	28	85	11.7
G8A01160	16.0	16	16	32	90	15.7
G8A01200	20.0	20	20	40	105	19.7

Due to the characteristics of the blue decoration layer, it might be erased during short term use and the color layer might not be uniformed. However, it doesn't affect the performance of the tool.

Size	Mill Dia. Tolerance (mm)	Shank Dia. Tolerance
up to Ø6	0 ~ - 0.012	h5
over Ø6	0 ~ - 0.015	

◎ : Excellent ○ : Good

ISO Material Description	P										M				K						
	Non-alloy steel					Low alloy steel					High alloyed steel, and tool steel				Stainless steel		Grey cast iron		Nodular cast iron		Malleable cast iron
VDI 3323	1	2	3	4	5	6	7	8	9	10	11	12	13	14	15	16	17	18	19	20	
HRC																					
HB	125	190	250	270	300	180	275	300	350	200	325	200	240	180	180	260	160	250	130	230	
Recommend	○					○					○										

ISO Material Description	N					S										H						
	Aluminum-wrought alloy		Aluminum-cast, alloyed		Copper and Copper Alloys (Bronze / Brass)	Non Metallic Materials		Heat Resistant Super Alloys					Titanium Alloys			Hardened steel	Chilled Cast Iron	Hardened Cast Iron				
VDI 3323	21	22	23	24	25	26	27	28	29	30	31	32	33	34	35	36	37	38	39	40	41	
HRC																						
HB	60	100	75	90	130	110	90	100			200	280	250	350	320	400 Rm	1050 Rm	550	630	400	550	
Recommend																			◎	◎	○	◎



CARBIDE, 4 FLUTE with EXTENDED NECK

- **VOLLHARTMETALL, 4 SCHNEIDEN mit ABGESETZTEM SCHAFTTEIL**
- **Fraise carbure, 4 dents, détalonnée**
- **4 TAGLIENTI CON SCARICO ESTESO**

- ▶ Designed to machine high hardened materials.
 - ▶ Suitable for dry cutting, high speed cutting thanks to newly developed raw-material and new coating.
 - ▶ Excellent workpiece finish.
 - ▶ Designed for high precision milling operation.
 - ▶ Higher wear-resistance.
- ▶ Geeignet zum Fräsen hochgehärteter Stähle.
 - ▶ Geeignet zum Trockenfräsen und HSC-Fräsen dank neuentwickeltem Material und Beschichtung.
 - ▶ Excellente Werkstückoberflächen.
 - ▶ Geeignet für hochpräzises Fräsen.
 - ▶ Höhere Verschleißfestigkeit.

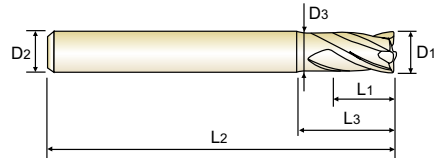
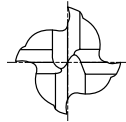

Unit : mm

EDP No.	Mill Diameter	Shank Diameter	Length of Cut	Length Below Shank	Overall Length	Neck Diameter
	D1	D2	L1	L3	L2	D3
G8A02010	1.0	6	1.5	3	50	0.95
G8A02020	2.0	6	2	5	50	1.95
G8A02030	3.0	6	3	8	55	2.85
G8A02040	4.0	6	4	10	55	3.85
G8A02050	5.0	6	5	13	55	4.85
G8A02060	6.0	6	6	15	55	5.85
G8A02080	8.0	8	8	20	65	7.7
G8A02100	10.0	10	10	25	75	9.7
G8A02120	12.0	12	12	28	85	11.7
G8A02160	16.0	16	16	32	90	15.7
G8A02200	20.0	20	20	40	105	19.7

Due to the characteristics of the blue decoration layer, it might be erased during short term use and the color layer might not be uniformed. However, it doesn't affect the performance of the tool.

Size	Mill Dia. Tolerance (mm)	Shank Dia. Tolerance
up to Ø6	0 ~ - 0.012	h5
over Ø6	0 ~ - 0.015	

◎ : Excellent ○ : Good

ISO Material Description	P											M			K						
	Non-alloy steel					Low alloy steel						High alloyed steel, and tool steel			Stainless steel			Grey cast iron		Nodular cast iron	
VDI 3323	1	2	3	4	5	6	7	8	9	10	11	12	13	14	15	16	17	18	19	20	
HRc		13	25	28	32	10	29	32	38	15	35	15	23	10	10	26	3	25		21	
HB	125	190	250	270	300	180	275	300	350	200	325	200	240	180	180	260	160	250	130	230	
Recommend					○			○	○		○										
ISO Material Description	N										S							H			
	Aluminum-wrought alloy		Aluminum-cast, alloyed			Copper and Copper Alloys (Bronze / Brass)			Non Metallic Materials		Heat Resistant Super Alloys					Titanium Alloys		Hardened steel	Chilled Cast Iron	Hardened Cast Iron	
VDI 3323	21	22	23	24	25	26	27	28	29	30	31	32	33	34	35	36	37	38	39	40	41
HRc											15	30	25	38	34			55	60	42	55
HB	60	100	75	90	130	110	90	100			200	280	250	350	320	400 Rm	1050 Rm	550	630	400	550
Recommend																		◎	◎	○	◎

CARBIDE, 6&8 FLUTE 45° HELIX LONG LENGTH

- VOLLHARTMETALL, 6&8 SCHNEIDEN 45° RECHTSSPIRALE LANG
- (.) Fraise carbure, 6&8 dents, hélice 45°, longue
- (.) 6&8 TAGLIANTI, ELICA 45°, TAGLIENTE LUNGO

- ▶ Designed to machine high hardened materials.
- ▶ Designed for high abrasion resistance thanks to negative rake angle.
- ▶ Excellent side-cutting of press mold field.
- ▶ Speziell ausgelegt für die Hartbearbeitung
- ▶ Ausgelegt für hohe Abriebfestigkeit dank der negativen Spanwinkel.
- ▶ hervorragend geeignet für die Seitenbearbeitung im Formenbau

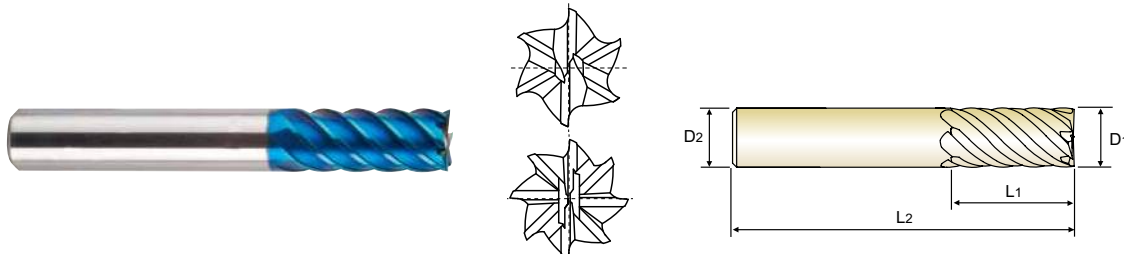

Unit : mm

EDP No.	Mill Diameter	Shank Diameter	Length of Cut	Overall Length	No. of Flute
	D1	D2	L1	L2	
G8D63060	6.0	6	13	57	6
G8D63080	8.0	8	19	63	6
G8D63100	10.0	10	22	72	6
G8D63120	12.0	12	26	83	6
G8D63140	14.0	14	26	83	6
G8D63160	16.0	16	32	92	6
G8D63180	18.0	18	32	92	8
G8D63200	20.0	20	38	104	8
G8D63250	25.0	25	44	104	8

Due to the characteristics of the blue decoration layer, it might be erased during short term use and the color layer might not be uniformed. However, it doesn't affect the performance of the tool.

Mill Dia. Tolerance (mm)	Shank Dia. Tolerance
0 ~ - 0.02	h5

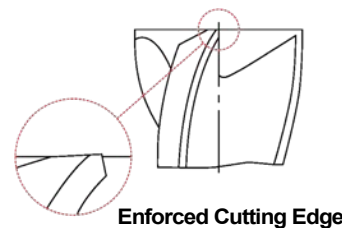

◎ : Excellent ○ : Good

ISO Material Description	P										M			K							
	Non-alloy steel					Low alloy steel					High alloyed steel, and tool steel			Stainless steel			Grey cast iron		Nodular cast iron		Malleable cast iron
VDI 3323	1	2	3	4	5	6	7	8	9	10	11	12	13	14	15	16	17	18	19	20	
HRc	13	25	28	32	300	10	29	32	38	15	35	15	23	10	10	26	3	25	21		
HB	125	190	250	270	300	180	275	300	350	200	325	200	240	180	180	260	160	250	130	230	
Recommend					○				○	○	○										
ISO Material Description	N					S					H										
	Aluminum-wrought alloy		Aluminum-cast, alloyed			Copper and Copper Alloys (Bronze / Brass)			Non Metallic Materials		Heat Resistant Super Alloys					Titanium Alloys		Hardened steel	Chilled Cast Iron	Hardened Cast Iron	
VDI 3323	21	22	23	24	25	26	27	28	29	30	31	32	33	34	35	36	37	38	39	40	41
HRc											15	30	25	38	34	55	60	55	60	42	55
HB	60	100	75	90	130	110	90	100			200	280	250	350	320	400 Rm	1050 Rm	550	630	400	550
Recommend																		◎	◎	○	◎



CARBIDE, 6&8 FLUTE 45° HELIX EXTRA LONG LENGTH

- VOLLHARTMETALL, 6&8 SCHNEIDEN 45° RECHTSSPIRALE EXTRA LANG
- Fraise carbure, 6&8 dents, hélice 45°, extra-longue
- 6&8 TAGLIENTI, ELICA 45°, TAGLIENTE EXTRA LUNGO

- ▶ Designed to machine high hardened materials.
- ▶ Designed for high abrasion resistance thanks to negative rake angle.
- ▶ Excellent side-cutting of press mold field.

- ▶ Speziell ausgelegt für die Hartbearbeitung
- ▶ Ausgelegt für hohe Abriebfestigkeit dank der negativen Spanwinkel.
- ▶ Hervorragend geeignet für die Seitenbearbeitung im Formenbau

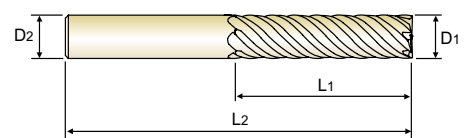
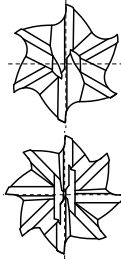

P.159

Unit : mm

EDP No.	Mill Diameter	Shank Diameter	Length of Cut	Overall Length	No. of Flute
	D1	D2	L1	L2	
G8D64060	6.0	6	26	70	6
G8D64080	8.0	8	36	90	6
G8D64100	10.0	10	46	100	6
G8D64120	12.0	12	56	110	6
G8D64160	16.0	16	66	130	6
G8D64200	20.0	20	76	140	8
G8D64250	25.0	25	92	180	8

Due to the characteristics of the blue decoration layer, it might be erased during short term use and the color layer might not be uniformed. However, it doesn't affect the performance of the tool.

Mill Dia. Tolerance (mm)	Shank Dia. Tolerance
0 ~ - 0.03	h5

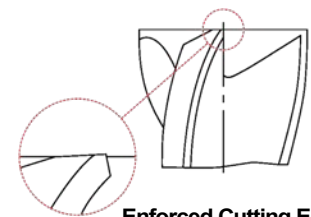

Enforced Cutting Edge

◎ : Excellent ○ : Good

ISO Material Description	P											M			K						
	Non-alloy steel					Low alloy steel						High alloyed steel, and tool steel			Stainless steel			Grey cast iron		Nodular cast iron	
VDI 3323	1	2	3	4	5	6	7	8	9	10	11	12	13	14	15	16	17	18	19	20	
HRc		13	25	28	32	10	29	32	38	15	35	15	23	10	10	26	3	25		21	
HB	125	190	250	270	300	180	275	300	350	200	325	200	240	180	180	260	160	250	130	230	
Recommend					○			○	○		○										
ISO Material Description	N										S							H			
	Aluminum-wrought alloy		Aluminum-cast, alloyed			Copper and Copper Alloys (Bronze / Brass)			Non Metallic Materials		Heat Resistant Super Alloys					Titanium Alloys		Hardened steel	Chilled Cast Iron	Hardened Cast Iron	
VDI 3323	21	22	23	24	25	26	27	28	29	30	31	32	33	34	35	36	37	38	39	40	41
HRc											15	30	25	38	34			55	60	42	55
HB	60	100	75	90	130	110	90	100			200	280	250	350	320	400 Rm	1050 Rm	550	630	400	550
Recommend																		◎	◎	○	◎



RECOMMENDED CUTTING CONDITIONS
EMPFOHLENE SCHNEIDPARAMETER

G8A46, G8A54 SERIES

2 FLUTE BALL NOSE FOR RIB PROCESSING

Vc = m/min.
fz = mm/tooth
RPM = rev./min.
FEED = mm/min.
Ap = mm

ISO	VDI 3323	Material Description	Parameter	Diameter (Ø)				
				0.2	0.3	0.4	0.5	0.6
P	5	Non-alloy steel	Vc	31	45~47	60~63	50~55	50~56
			fz	0.003~0.004	0.005~0.005	0.007~0.008	0.006~0.013	0.007~0.015
			RPM	50000	48000~50000	48000~50000	31900~35200	26400~29700
			FEED	265~310	440~460	450~550	450~540	440~540
			Ap	0.006~0.016	0.010~0.017	0.013~0.032	0.007~0.028	0.007~0.034
			Ap	0.006~0.016	0.010~0.017	0.013~0.032	0.007~0.028	0.007~0.034
	8-9	Low alloy steel	Vc	31	45~47	60~63	54~78	54~77
			fz	0.003~0.004	0.005~0.005	0.007~0.008	0.006~0.013	0.007~0.015
			RPM	50000	48000~50000	48000~50000	34100~49500	28600~40700
			FEED	300~350	480~520	720~790	600~870	590~850
			Ap	0.006~0.016	0.010~0.017	0.013~0.032	0.007~0.028	0.007~0.034
			Ap	0.006~0.016	0.010~0.017	0.013~0.032	0.007~0.028	0.007~0.034
11.1 - 11.2	High alloyed steel, and tool steel	Vc	31	45~47	60~63	54~78	54~77	
		fz	0.003~0.004	0.005~0.005	0.007~0.008	0.006~0.013	0.007~0.015	
		RPM	50000	48000~50000	48000~50000	34100~49500	28600~40700	
		FEED	300~350	480~520	720~790	600~870	590~850	
		Ap	0.006~0.016	0.010~0.017	0.013~0.032	0.007~0.028	0.007~0.034	
		Ap	0.006~0.016	0.010~0.017	0.013~0.032	0.007~0.028	0.007~0.034	
H	38.1 - 38.2	Hardened steel	Vc	31	45~47	60~63	50~55	50~56
			fz	0.003~0.003	0.004~0.005	0.005~0.006	0.006~0.008	0.007~0.010
			RPM	50000	48000~50000	48000~50000	31900~35200	26400~29700
			FEED	265~310	440~460	450~550	450~540	440~540
			Ap	0.005~0.013	0.008~0.014	0.011~0.026	0.005~0.023	0.006~0.028
			Ap	0.005~0.013	0.008~0.014	0.011~0.026	0.005~0.023	0.006~0.028
	39.1	Hardened steel	Vc	31	43~47	58~63	50~55	50~56
			fz	0.009~0.011	0.017~0.017	0.017~0.018	0.028~0.027	0.030~0.032
			RPM	50000	46000~50000	46000~50000	31900~35200	26400~29700
			FEED	225~265	390~420	400~460	440~480	400~480
			Ap	0.005~0.012	0.007~0.013	0.010~0.024	0.005~0.021	0.006~0.025
			Ap	0.005~0.012	0.007~0.013	0.010~0.024	0.005~0.021	0.006~0.025
	39.2	Hardened steel	Vc	31	43~47	58~63	50~55	50~56
			fz	0.009~0.011	0.017~0.017	0.017~0.018	0.028~0.027	0.030~0.032
			RPM	50000	46000~50000	46000~50000	31900~35200	26400~29700
			FEED	225~265	390~420	400~460	440~480	400~480
			Ap	0.005~0.012	0.007~0.013	0.010~0.024	0.005~0.021	0.006~0.025
			Ap	0.005~0.012	0.007~0.013	0.010~0.024	0.005~0.021	0.006~0.025
40	Chilled Cast Iron	Vc	31	45~47	60~63	54~78	54~77	
		fz	0.003~0.004	0.005~0.005	0.007~0.008	0.006~0.013	0.007~0.015	
		RPM	50000	48000~50000	48000~50000	34100~49500	28600~40700	
		FEED	300~350	480~520	720~790	600~870	590~850	
		Ap	0.006~0.016	0.010~0.017	0.013~0.032	0.007~0.028	0.007~0.034	
		Ap	0.006~0.016	0.010~0.017	0.013~0.032	0.007~0.028	0.007~0.034	
41	Hardened Cast Iron	Vc	31	45~47	60~63	50~55	50~56	
		fz	0.003~0.003	0.004~0.005	0.005~0.006	0.006~0.008	0.007~0.010	
		RPM	50000	48000~50000	48000~50000	31900~35200	26400~29700	
		FEED	265~310	440~460	450~550	450~540	440~540	
		Ap	0.005~0.013	0.008~0.014	0.011~0.026	0.005~0.023	0.006~0.028	
		Ap	0.005~0.013	0.008~0.014	0.011~0.026	0.005~0.023	0.006~0.028	

▶ NEXT PAGE

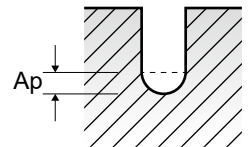

G8A46, G8A54 SERIES

2 FLUTE BALL NOSE FOR RIB PROCESSING

Vc = m/min.
fz = mm/tooth
RPM = rev./min.
FEED = mm/min.
Ap = mm

VDI 3323	Parameter	Diameter (Ø)						
		0.8	1.0	1.2	1.5	2.0	3.0	4.0
5	Vc	50~55	48~55	45~53	47~54	50~55	50~55	50~55
	fz	0.010~0.020	0.012~0.024	0.016~0.027	0.020~0.035	0.027~0.047	0.045~0.088	0.055~0.115
	RPM	19800~22000	15400~17600	12000~14000	10000~11500	7900~8800	5300~5800	3950~4400
	FEED	460~550	470~540	460~540	440~540	470~530	590~650	550~620
8-9	Ap	0.016~0.064	0.008~0.080	0.024~0.032	0.031~0.048	0.024~0.160	0.064~0.240	0.080~0.320
	Vc	55~77	55~76	54~70	52~67	53~69	54~77	54~78
	fz	0.010~0.020	0.012~0.024	0.016~0.027	0.020~0.035	0.027~0.047	0.045~0.088	0.055~0.115
	RPM	22000~30800	17600~24200	14300~18700	11000~14300	8500~11000	5700~8200	4300~6200
11.1 - 11.2	FEED	640~890	600~850	590~780	580~760	590~800	730~1000	680~990
	Ap	0.016~0.064	0.008~0.080	0.024~0.032	0.031~0.048	0.024~0.160	0.064~0.240	0.080~0.320
	Vc	55~77	55~76	54~70	52~67	53~69	54~77	54~78
	fz	0.010~0.020	0.012~0.024	0.016~0.027	0.020~0.035	0.027~0.047	0.045~0.088	0.055~0.115
38.1 - 38.2	RPM	22000~30800	17600~24200	14300~18700	11000~14300	8500~11000	5700~8200	4300~6200
	FEED	640~890	600~850	590~780	580~760	590~800	730~1000	680~990
	Ap	0.016~0.064	0.008~0.080	0.024~0.032	0.031~0.048	0.024~0.160	0.064~0.240	0.080~0.320
	Vc	50~55	48~55	45~53	47~54	50~55	50~55	50~55
39.1	fz	0.010~0.014	0.013~0.018	0.016~0.023	0.019~0.027	0.027~0.034	0.051~0.061	0.063~0.078
	RPM	19800~22000	15400~17600	12000~14000	10000~11500	7900~8800	5300~5800	3950~4400
	FEED	460~550	470~540	460~540	440~540	470~530	590~650	550~620
	Ap	0.013~0.052	0.007~0.065	0.020~0.026	0.025~0.039	0.020~0.130	0.052~0.195	0.065~0.260
39.2	Vc	50~55	48~55	45~53	47~54	50~55	50~55	48~55
	fz	0.044~0.045	0.057~0.057	0.070~0.069	0.084~0.083	0.111~0.109	0.208~0.214	0.275~0.259
	RPM	19800~22000	15400~17600	12000~14000	10000~11500	7900~8800	5300~5800	3850~4400
	FEED	440~500	440~500	420~480	420~480	440~480	550~620	530~570
39.2	Ap	0.012~0.048	0.006~0.060	0.018~0.024	0.023~0.036	0.018~0.120	0.048~0.120	0.060~0.240
	Vc	50~55	48~55	45~53	47~54	50~55	50~55	48~55
	fz	0.044~0.045	0.057~0.057	0.070~0.069	0.084~0.083	0.111~0.109	0.208~0.214	0.275~0.259
	RPM	19800~22000	15400~17600	12000~14000	10000~11500	7900~8800	5300~5800	3850~4400
40	FEED	440~500	440~500	420~480	420~480	440~480	550~620	530~570
	Ap	0.012~0.048	0.006~0.060	0.018~0.024	0.023~0.036	0.018~0.120	0.048~0.120	0.060~0.240
	Vc	55~77	55~76	54~70	52~67	53~69	54~77	54~78
	fz	0.010~0.020	0.012~0.024	0.016~0.027	0.020~0.035	0.027~0.047	0.045~0.088	0.055~0.115
41	RPM	22000~30800	17600~24200	14300~18700	11000~14300	8500~11000	5700~8200	4300~6200
	FEED	640~890	600~850	590~780	580~760	590~800	730~1000	680~990
	Ap	0.016~0.064	0.008~0.080	0.024~0.032	0.031~0.048	0.024~0.160	0.064~0.240	0.080~0.320
	Vc	50~55	48~55	45~53	47~54	50~55	50~55	50~55
41	fz	0.010~0.014	0.013~0.018	0.016~0.023	0.019~0.027	0.027~0.034	0.051~0.061	0.063~0.078
	RPM	19800~22000	15400~17600	12000~14000	10000~11500	7900~8800	5300~5800	3950~4400
	FEED	460~550	470~540	460~540	440~540	470~530	590~650	550~620
	Ap	0.013~0.052	0.007~0.065	0.020~0.026	0.025~0.039	0.020~0.130	0.052~0.195	0.065~0.260

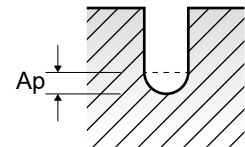

HSS

CBN END MILLS

i-Xmill END MILLS

i-SMART MODULAR END MILLS

X5070 END MILLS

4G MILL END MILLS

X-POWER PRO END MILLS

TitaNox-POWER END MILLS

JET-POWER END MILLS

V7 PLUS END MILLS

ALU-POWER HPC END MILLS

ALU-POWER END MILLS

D-POWER GRAPHITE END MILLS

D-POWER CFRP END MILLS

ROUTERS

CRX S END MILLS

K-2 END MILLS

ONLY ONE COATED PM60 END MILLS

TANK-POWER END MILLS

GENERAL HSS END MILLS

MILLING CUTTERS

TECHNICAL DATA

G8A28, G8A38, G8A53 SERIES 2 FLUTE BALL NOSE

Vc = m/min.
fz = mm/tooth
RPM = rev./min.
FEED = mm/min.

ISO	VDI 3323	Material Description	Ae	Ap	Parameter	Diameter (Ø)						
						0.2	0.3	0.4	0.5	0.6	0.8	1.0
P	5	Non-alloy steel	0.05D	0.02D	Vc	30	45	65	80	95	125	155
					fz	0.012	0.015	0.019	0.024	0.029	0.039	0.048
					RPM	47746	47746	51725	50930	50399	49736	49338
	8-9	Low alloy steel	0.05D	0.02D	Vc	30	45	65	80	95	125	155
					fz	0.012	0.015	0.019	0.024	0.029	0.039	0.048
					RPM	47746	47746	51725	50930	50399	49736	49338
	11.1	High alloyed steel, and tool steel	0.05D	0.02D	Vc	30	45	65	80	95	125	155
					fz	0.012	0.015	0.019	0.024	0.029	0.039	0.048
					RPM	47746	47746	51725	50930	50399	49736	49338
	11.2	High alloyed steel, and tool steel	0.05D	0.02D	Vc	30	45	65	80	95	125	155
					fz	0.011	0.014	0.017	0.021	0.025	0.033	0.042
					RPM	47746	47746	51725	50930	50399	49736	49338
H	38.1	Hardened steel	0.05D	0.02D	Vc	30	45	65	80	95	125	155
					fz	0.011	0.014	0.017	0.021	0.025	0.033	0.042
					RPM	47746	47746	51725	50930	50399	49736	49338
	38.2	Hardened steel	0.05D	0.02D	Vc	30	40	55	70	85	115	140
					fz	0.011	0.013	0.017	0.021	0.024	0.033	0.042
					RPM	47746	42441	43768	44563	45094	45757	44563
	39.1	Hardened steel	0.05D	0.02D	Vc	25	40	50	65	75	100	125
					fz	0.01	0.012	0.015	0.019	0.023	0.03	0.038
					RPM	39789	42441	39789	41380	39789	39789	39789
	39.2	Hardened steel	0.05D	0.02D	Vc	20	35	45	55	65	90	110
					fz	0.01	0.012	0.015	0.019	0.023	0.03	0.037
					RPM	31831	37136	35810	35014	34484	35810	35014
39.3	Hardened steel	0.05D	0.02D	Vc	20	30	40	50	60	80	110	
				fz	0.009	0.011	0.014	0.017	0.022	0.029	0.033	
				RPM	31831	31831	31831	31831	31831	31831	35014	
40	Chilled Cast Iron	0.05D	0.02D	Vc	30	45	65	80	95	125	155	
				fz	0.011	0.014	0.017	0.021	0.025	0.033	0.042	
				RPM	47746	47746	51725	50930	50399	49736	49338	
41	Hardened Cast Iron	0.05D	0.02D	Vc	30	40	55	70	85	115	140	
				fz	0.011	0.013	0.017	0.021	0.024	0.033	0.042	
				RPM	47746	47746	51725	50930	50399	49736	49338	

▶ NEXT PAGE

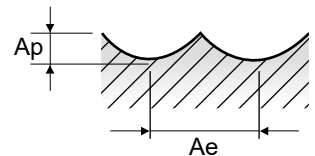

YG X5070 END MILLS

RECOMMENDED CUTTING CONDITIONS
EMPFOHLENE SCHNEIDPARAMETER

G8A28, G8A38, G8A53 SERIES 2 FLUTE BALL NOSE

Vc = m/min.
fz = mm/tooth
RPM = rev./min.
FEED = mm/min.

VDI 3323	Parameter	Diameter (Ø)											
		1.2	1.5	2.0	3.0	4.0	5.0	6.0	8.0	10.0	12.0	16.0	20.0
5	Vc	190	235	310	310	315	290	260	280	290	260	280	280
	fz	0.051	0.054	0.057	0.091	0.12	0.156	0.174	0.189	0.199	0.212	0.238	0.264
	RPM	50399	49869	49338	32892	25067	18462	13793	11141	9231	6897	5570	4456
8-9	Vc	190	235	310	310	315	290	260	280	290	260	280	280
	fz	0.051	0.054	0.057	0.091	0.12	0.156	0.174	0.189	0.199	0.212	0.238	0.264
	RPM	50399	49869	49338	32892	25067	18462	13793	11141	9231	6897	5570	4456
111	Vc	190	235	310	310	315	290	260	280	290	260	280	280
	fz	0.051	0.054	0.057	0.091	0.12	0.156	0.174	0.189	0.199	0.212	0.238	0.264
	RPM	50399	49869	49338	32892	25067	18462	13793	11141	9231	6897	5570	4456
112	Vc	180	225	300	300	300	280	255	270	280	250	270	270
	fz	0.045	0.047	0.05	0.083	0.111	0.138	0.153	0.164	0.174	0.187	0.206	0.227
	RPM	47746	47746	47746	31831	23873	17825	13528	10743	8913	6631	5371	4297
38.1	Vc	180	225	300	300	300	280	255	270	280	250	270	270
	fz	0.045	0.047	0.05	0.083	0.111	0.138	0.153	0.164	0.174	0.187	0.206	0.227
	RPM	47746	47746	47746	31831	23873	17825	13528	10743	8913	6631	5371	4297
38.2	Vc	160	205	250	250	250	235	205	225	235	210	225	225
	fz	0.045	0.047	0.05	0.075	0.1	0.125	0.141	0.15	0.16	0.17	0.189	0.208
	RPM	42441	43502	39789	26526	19894	14961	10876	8952	7480	5570	4476	3581
39.1	Vc	145	175	220	220	220	210	190	200	205	190	200	200
	fz	0.039	0.042	0.045	0.067	0.09	0.113	0.125	0.134	0.144	0.155	0.169	0.188
	RPM	38462	37136	35014	23343	17507	13369	10080	7958	6525	5040	3979	3183
39.2	Vc	130	155	200	200	200	180	165	175	180	165	175	175
	fz	0.04	0.041	0.044	0.067	0.088	0.111	0.122	0.132	0.142	0.142	0.143	0.143
	RPM	34484	32892	31831	21221	15915	11459	8754	6963	5730	4377	3482	2785
39.3	Vc	115	140	180	180	180	165	150	165	165	150	160	160
	fz	0.038	0.039	0.04	0.061	0.079	0.1	0.109	0.119	0.13	0.131	0.133	0.129
	RPM	30505	29709	28648	19099	14324	10504	7958	6565	5252	3979	3183	2546
40	Vc	180	225	300	300	300	280	255	270	280	250	270	270
	fz	0.045	0.047	0.05	0.083	0.111	0.138	0.153	0.164	0.174	0.187	0.206	0.227
	RPM	47746	47746	47746	31831	23873	17825	13528	10743	8913	6631	5371	4297
41	Vc	160	205	250	250	250	235	205	225	235	210	225	225
	fz	0.045	0.047	0.05	0.075	0.1	0.125	0.141	0.15	0.16	0.17	0.189	0.208
	RPM	47746	47746	47746	31831	23873	17825	13528	10743	8913	6631	5371	4297

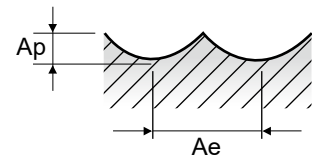

HSS

CBN END MILLS

i-Xmill END MILLS

i-SMART MODULAR END MILLS

X5070 END MILLS

4G MILL END MILLS

X-POWER PRO END MILLS

TitaNox-POWER END MILLS

JET-POWER END MILLS

V7 PLUS END MILLS

ALU-POWER HPC END MILLS

ALU-POWER END MILLS

D-POWER GRAPHITE END MILLS

D-POWER CFRP END MILLS

ROUTERS

CRX S END MILLS

K-2 END MILLS

ONLY ONE COATED PM60 END MILLS

TANK-POWER END MILLS

GENERAL HSS END MILLS

MILLING CUTTERS

TECHNICAL DATA



RECOMMENDED CUTTING CONDITIONS
EMPFOHLENE SCHNEIDPARAMETER

G8A59 SERIES **3 FLUTE BALL NOSE**

Vc = m/min.
fz = mm/tooth
RPM = rev./min.
FEED = mm/min.

ISO	VDI 3323	Material Description	Ae	Ap	Parameter	Diameter (Ø)									
						3.0	4.0	5.0	6.0	8.0	10.0	12.0	16.0	20.0	
P	5	Non-alloy steel	0.05D	0.02D	Vc	300	305	315	340	340	340	340	335	340	
					fz	0.09	0.107	0.121	0.159	0.181	0.202	0.225	0.229	0.222	
					RPM	31831	24271	20054	18038	13528	10823	9019	6665	5411	
	8-9	Low alloy steel	0.05D	0.02D	Vc	300	305	315	340	340	340	340	335	340	
					fz	0.09	0.107	0.121	0.159	0.181	0.202	0.225	0.229	0.222	
					RPM	31831	24271	20054	18038	13528	10823	9019	6665	5411	
	11.1 - 11.2	High alloyed steel, and tool steel	0.05D	0.02D	Vc	300	305	315	340	340	340	340	335	340	
					fz	0.09	0.107	0.121	0.159	0.181	0.202	0.225	0.229	0.222	
					RPM	31831	24271	20054	18038	13528	10823	9019	6665	5411	
H	38.1 - 38.2	Hardened steel	0.05D	0.02D	Vc	255	255	265	285	285	285	285	285	285	
					fz	0.072	0.09	0.108	0.136	0.155	0.168	0.187	0.19	0.192	
					RPM	27056	20292	16870	15120	11340	9072	7560	5670	4536	
	39.1		0.05D	0.02D	Vc	185	185	195	230	230	230	230	230	230	
					fz	0.072	0.087	0.099	0.123	0.144	0.156	0.173	0.18	0.18	
					RPM	19629	14722	12414	12202	9151	7321	6101	4576	3661	
	39.2		0.05D	0.02D	Vc	175	180	185	210	210	210	210	210	205	
					fz	0.072	0.086	0.099	0.115	0.134	0.144	0.145	0.144	0.145	
					RPM	18568	14324	11777	11141	8356	6685	5570	4178	3263	
39.3	0.05D	0.02D	Vc	120	120	125	145	145	145	145	145	145			
			fz	0.072	0.087	0.099	0.108	0.125	0.144	0.144	0.144	0.143			
			RPM	12732	9549	7958	7692	5769	4615	3846	2885	2308			
40	Chilled Cast Iron	0.05D	0.02D	Vc	300	305	315	340	340	340	340	335	340		
				fz	0.09	0.107	0.121	0.159	0.181	0.202	0.225	0.229	0.222		
				RPM	31831	24271	20054	18038	13528	10823	9019	6665	5411		
41	Hardened Cast Iron	0.05D	0.02D	Vc	255	255	265	285	285	285	285	285	285		
				fz	0.072	0.09	0.108	0.136	0.155	0.168	0.187	0.19	0.192		
				RPM	27056	20292	16870	15120	11340	9072	7560	5670	4536		

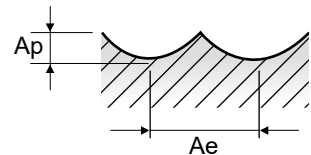

G8D62 SERIES
4 FLUTE BALL NOSE

Vc = m/min.
fz = mm/tooth
RPM = rev./min.
FEED = mm/min.

ISO	VDI 3323	Material Description	Ae	Ap	Parameter	Diameter (Ø)									
						3.0	4.0	5.0	6.0	8.0	10.0	12.0	16.0	20.0	
P	5	Non-alloy steel	0.05D	0.02D	Vc	340	340	340	340	340	340	340	340	340	340
					fz	0.071	0.08	0.09	0.101	0.116	0.128	0.145	0.144	0.144	
					RPM	36075	27056	21645	18038	13528	10823	9019	6764	5411	
	8-9	Low alloy steel	0.05D	0.02D	Vc	340	340	340	340	340	340	340	340	340	340
					fz	0.071	0.08	0.09	0.101	0.116	0.128	0.145	0.144	0.144	
					RPM	36075	27056	21645	18038	13528	10823	9019	6764	5411	
	11.1 - 11.2	High alloyed steel, and tool steel	0.05D	0.02D	Vc	340	340	340	340	340	340	340	340	340	340
					fz	0.071	0.08	0.09	0.101	0.116	0.128	0.145	0.144	0.144	
					RPM	36075	27056	21645	18038	13528	10823	9019	6764	5411	
H	38.1 - 38.2	Hardened steel	0.05D	0.02D	Vc	285	285	280	285	285	285	285	285	285	
					fz	0.06	0.07	0.081	0.092	0.103	0.111	0.125	0.129	0.126	
					RPM	30239	22680	17825	15120	11340	9072	7560	5670	4536	
	39.1		0.05D	0.02D	Vc	230	230	230	230	230	230	230	230	230	
					fz	0.05	0.06	0.071	0.082	0.096	0.104	0.115	0.119	0.119	
					RPM	24404	18303	14642	12202	9151	7321	6101	4576	3661	
	39.2	0.05D	0.02D	Vc	210	210	210	210	210	210	210	210	205		
				fz	0.045	0.055	0.067	0.077	0.089	0.095	0.097	0.096	0.096		
				RPM	22282	16711	13369	11141	8356	6685	5570	4178	3263		
	39.3	0.05D	0.02D	Vc	145	145	145	145	145	145	145	145	140		
				fz	0.04	0.05	0.062	0.072	0.082	0.096	0.094	0.096	0.097		
				RPM	15385	11539	9231	7692	5769	4615	3846	2885	2228		
	40	Chilled Cast Iron	0.05D	0.02D	Vc	340	340	340	340	340	340	340	340	340	
					fz	0.071	0.08	0.09	0.101	0.116	0.128	0.145	0.144	0.144	
					RPM	36075	27056	21645	18038	13528	10823	9019	6764	5411	
	41	Hardened Cast Iron	0.05D	0.02D	Vc	285	285	280	285	285	285	285	285	285	
					fz	0.06	0.07	0.081	0.092	0.103	0.111	0.125	0.129	0.126	
					RPM	30239	22680	17825	15120	11340	9072	7560	5670	4536	

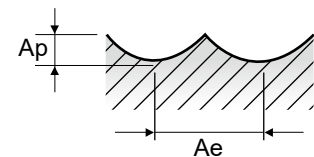



RECOMMENDED CUTTING CONDITIONS
EMPFOHLENE SCHNEIDPARAMETER

G8A60 SERIES **2 FLUTE CORNER RADIUS - SLOTTING**

Vc = m/min.
fz = mm/tooth
RPM = rev./min.
FEED = mm/min.

ISO	VDI 3323	Material Description	Ae	Ap	Parameter	Diameter (Ø)											
						0.5	0.6	0.8	1.0	2.0	3.0	4.0	5.0	6.0	8.0	10.0	12.0
P	5	Non-alloy steel	1.0D	0.05D	Vc	80	95	125	150	210	205	210	245	245	250	245	250
					fz	0.001	0.002	0.002	0.006	0.01	0.015	0.021	0.026	0.029	0.037	0.043	0.051
					RPM	50930	50399	49736	47746	33423	21751	16711	15597	12998	9947	7799	6631
					FEED	102	202	199	573	668	653	702	811	754	736	671	676
	8-9	Low alloy steel	1.0D	0.05D	Vc	80	95	125	150	210	205	210	245	245	250	245	250
					fz	0.001	0.002	0.002	0.006	0.01	0.015	0.021	0.026	0.029	0.037	0.043	0.051
					RPM	50930	50399	49736	47746	33423	21751	16711	15597	12998	9947	7799	6631
					FEED	102	202	199	573	668	653	702	811	754	736	671	676
	11.1	High alloyed steel, and tool steel	1.0D	0.05D	Vc	80	95	125	150	210	205	210	245	245	250	245	250
					fz	0.001	0.002	0.002	0.006	0.01	0.015	0.021	0.026	0.029	0.037	0.043	0.051
					RPM	50930	50399	49736	47746	33423	21751	16711	15597	12998	9947	7799	6631
					FEED	102	202	199	573	668	653	702	811	754	736	671	676
11.2	High alloyed steel, and tool steel	1.0D	0.05D	Vc	70	85	100	120	165	165	165	195	195	195	195	200	
				fz	0.001	0.002	0.002	0.006	0.01	0.016	0.021	0.026	0.03	0.037	0.044	0.051	
				RPM	44563	45094	39789	38197	26261	17507	13130	12414	10345	7759	6207	5305	
				FEED	89	180	159	458	525	560	551	646	621	574	546	541	
H	38.1	Hardened steel	1.0D	0.05D	Vc	70	85	100	120	165	165	165	195	195	195	195	200
					fz	0.001	0.002	0.002	0.006	0.01	0.016	0.021	0.026	0.03	0.037	0.044	0.051
					RPM	44563	45094	39789	38197	26261	17507	13130	12414	10345	7759	6207	5305
					FEED	89	180	159	458	525	560	551	646	621	574	546	541
	38.2	Hardened steel	1.0D	0.05D	Vc	65	75	75	80	110	110	110	130	130	130	130	130
					fz	0.001	0.001	0.002	0.006	0.01	0.015	0.02	0.024	0.028	0.034	0.04	0.047
					RPM	41380	39789	29842	25465	17507	11671	8754	8276	6897	5173	4138	3448
					FEED	83	80	119	306	350	350	350	397	386	352	331	324
	39.1	Hardened steel	1.0D	0.05D	Vc	50	55	65	65	90	90	90	100	100	100	100	100
					fz	0.001	0.001	0.001	0.004	0.007	0.011	0.015	0.018	0.021	0.026	0.03	0.036
					RPM	31831	29178	25863	20690	14324	9549	7162	6366	5305	3979	3183	2653
					FEED	64	58	52	166	201	210	215	229	223	207	191	191
39.2	Hardened steel	1.0D	0.05D	Vc	40	45	50	50	70	70	70	80	80	80	80	80	
				fz	0.001	0.001	0.001	0.003	0.006	0.009	0.012	0.014	0.017	0.02	0.024	0.029	
				RPM	25465	23873	19894	15915	11141	7427	5570	5093	4244	3183	2546	2122	
				FEED	51	48	40	95	134	134	134	144	144	127	122	123	
39.3	Hardened steel	1.0D	0.02D	Vc	30	40	40	40	60	60	60	70	70	70	70	70	
				fz	0.001	0.001	0.001	0.003	0.005	0.007	0.01	0.012	0.014	0.017	0.021	0.024	
				RPM	19099	21221	15915	12732	9549	6366	4775	4456	3714	2785	2228	1857	
				FEED	19	25	29	71	90	89	96	105	100	95	91	90	
40	Chilled Cast Iron	1.0D	0.05D	Vc	70	85	100	120	165	165	165	195	195	195	195	200	
				fz	0.001	0.002	0.002	0.006	0.01	0.016	0.021	0.026	0.03	0.037	0.044	0.051	
				RPM	44563	45094	39789	38197	26261	17507	13130	12414	10345	7759	6207	5305	
				FEED	89	180	159	458	525	560	551	646	621	574	546	541	
41	Hardened Cast Iron	1.0D	0.05D	Vc	65	75	75	80	110	110	110	130	130	130	130	130	
				fz	0.001	0.001	0.002	0.006	0.01	0.015	0.02	0.024	0.028	0.034	0.04	0.047	
				RPM	41380	39789	29842	25465	17507	11671	8754	8276	6897	5173	4138	3448	
				FEED	83	80	119	306	350	350	350	397	386	352	331	324	

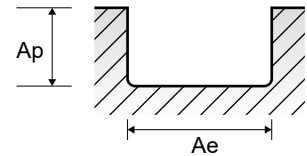

G8A60 SERIES

2 FLUTE CORNER RADIUS - SIDE CUTTING

Vc = m/min.
fz = mm/tooth
RPM = rev./min.
FEED = mm/min.

ISO	VDI 3323	Material Description	Ae	Ap	Parameter	Diameter (Ø)											
						0.5	0.6	0.8	1.0	2.0	3.0	4.0	5.0	6.0	8.0	10.0	12.0
P	5	Non-alloy steel	0.03D	1.0D	Vc	80	95	125	150	210	205	210	245	245	250	245	250
					fz	0.002	0.003	0.003	0.009	0.014	0.022	0.03	0.037	0.041	0.053	0.062	0.072
					RPM	50930	50399	49736	47746	33423	21751	16711	15597	12998	9947	7799	6631
	8-9	Low alloy steel	0.03D	1.0D	Vc	80	95	125	150	210	205	210	245	245	250	245	250
					fz	0.002	0.003	0.003	0.009	0.014	0.022	0.03	0.037	0.041	0.053	0.062	0.072
					RPM	50930	50399	49736	47746	33423	21751	16711	15597	12998	9947	7799	6631
	11.1	High alloyed steel, and tool steel	0.03D	1.0D	Vc	80	95	125	150	210	205	210	245	245	250	245	250
					fz	0.002	0.003	0.003	0.009	0.014	0.022	0.03	0.037	0.041	0.053	0.062	0.072
					RPM	50930	50399	49736	47746	33423	21751	16711	15597	12998	9947	7799	6631
	11.2	High alloyed steel, and tool steel	0.03D	1.0D	Vc	70	85	100	120	165	165	165	195	195	195	195	200
					fz	0.002	0.002	0.003	0.009	0.015	0.022	0.03	0.037	0.043	0.053	0.063	0.074
					RPM	44563	45094	39789	38197	26261	17507	13130	12414	10345	7759	6207	5305
H	38.1	Hardened steel	0.03D	1.0D	Vc	70	85	100	120	165	165	165	195	195	195	195	200
					fz	0.002	0.002	0.003	0.009	0.015	0.022	0.03	0.037	0.043	0.053	0.063	0.074
					RPM	44563	45094	39789	38197	26261	17507	13130	12414	10345	7759	6207	5305
	38.2	Hardened steel	0.03D	1.0D	Vc	65	75	75	80	110	110	110	130	130	130	130	130
					fz	0.002	0.002	0.003	0.008	0.014	0.021	0.028	0.034	0.04	0.049	0.058	0.067
					RPM	41380	39789	29842	25465	17507	11671	8754	8276	6897	5173	4138	3448
	39.1	Hardened steel	0.03D	1.0D	Vc	50	55	65	65	90	90	90	100	100	100	100	100
					fz	0.001	0.002	0.002	0.006	0.01	0.016	0.021	0.026	0.03	0.037	0.043	0.051
					RPM	31831	29178	25863	20690	14324	9549	7162	6366	5305	3979	3183	2653
	39.2	Hardened steel	0.03D	1.0D	Vc	40	45	50	50	70	70	70	80	80	80	80	80
					fz	0.001	0.001	0.002	0.005	0.008	0.012	0.017	0.02	0.024	0.029	0.035	0.042
					RPM	25465	23873	19894	15915	11141	7427	5570	5093	4244	3183	2546	2122
39.3	Hardened steel	0.03D	1.0D	Vc	30	40	40	40	60	60	60	70	70	70	70	70	
				fz	0.001	0.001	0.001	0.004	0.007	0.01	0.014	0.017	0.02	0.024	0.029	0.034	
				RPM	19099	21221	15915	12732	9549	6366	4775	4456	3714	2785	2228	1857	
40	Chilled Cast Iron	0.03D	1.0D	Vc	70	85	100	120	165	165	165	195	195	195	195	200	
				fz	0.002	0.002	0.003	0.009	0.015	0.022	0.03	0.037	0.043	0.053	0.063	0.074	
				RPM	44563	45094	39789	38197	26261	17507	13130	12414	10345	7759	6207	5305	
41	Hardened Cast Iron	0.03D	1.0D	Vc	65	75	75	80	110	110	110	130	130	130	130	130	
				fz	0.002	0.002	0.003	0.008	0.014	0.021	0.028	0.034	0.04	0.049	0.058	0.067	
				RPM	41380	39789	29842	25465	17507	11671	8754	8276	6897	5173	4138	3448	

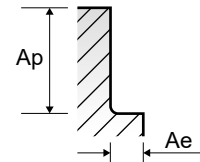

YG X5070 END MILLS

**RECOMMENDED CUTTING CONDITIONS
EMPFOHLENE SCHNEIDPARAMETER**

G8A52 SERIES

2 FLUTE CORNER RADIUS FOR RIB PROCESSING - **SLOTTING**

Vc = m/min.
fz = mm/tooth
RPM = rev./min.
FEED = mm/min.
Ap = mm

ISO	VDI 3323	Material Description	Parameter	Diameter (Ø)						
				0.5	0.6	0.8	1.0	1.2	1.5	2.0
P	5	Non-alloy steel	Vc	40~52	39~66	41~66	39~59	39~66	43~83	40~66
			fz	0.006~0.009	0.005~0.013	0.007~0.018	0.009~0.022	0.010~0.028	0.012~0.046	0.016~0.045
			RPM	25650~33000	20900~35200	16150~26400	12300~18700	10450~17600	9100~17600	6350~10550
			FEED	370~470	330~560	360~590	350~540	350~590	430~830	340~570
			Ap	0.0056~0.0350	0.0063~0.0294	0.0084~0.0392	0.0105~0.0280	0.0245~0.0700	0.0161~0.0770	0.0210~0.1400
			Vc	40~52	39~66	41~66	39~59	39~66	43~83	40~66
	8-9	Low alloy steel	fz	0.006~0.009	0.005~0.013	0.007~0.018	0.009~0.022	0.010~0.028	0.012~0.046	0.016~0.045
			RPM	25650~33000	20900~35200	16150~26400	12300~18700	10450~17600	9100~17600	6350~10550
			FEED	370~470	330~560	360~590	350~540	350~590	430~830	340~570
			Ap	0.0056~0.0350	0.0063~0.0294	0.0084~0.0392	0.0105~0.0280	0.0245~0.0700	0.0161~0.0770	0.0210~0.1400
			Vc	40~52	39~66	41~66	39~59	39~66	43~83	40~66
			fz	0.006~0.009	0.005~0.013	0.007~0.018	0.009~0.022	0.010~0.028	0.012~0.046	0.016~0.045
11.1 - 11.2	High alloyed steel, and tool steel	RPM	25650~33000	20900~35200	16150~26400	12300~18700	10450~17600	9100~17600	6350~10550	
		FEED	370~470	330~560	360~590	350~540	350~590	430~830	340~570	
		Ap	0.0056~0.0350	0.0063~0.0294	0.0084~0.0392	0.0105~0.0280	0.0245~0.0700	0.0161~0.0770	0.0210~0.1400	
		Vc	37~41	38~41	38~42	33~36	34~38	33~38	38~42	
		fz	0.005~0.007	0.004~0.007	0.006~0.010	0.008~0.013	0.009~0.015	0.011~0.020	0.015~0.025	
		RPM	23750~26000	19900~22000	15200~16700	10500~11500	9100~10000	7000~8000	6100~6700	
H	38.1 - 38.2	Hardened steel	FEED	285~315	190~290	210~310	190~280	180~280	180~280	200~300
			Ap	0.0040~0.0250	0.0450~0.0210	0.0060~0.0280	0.0075~0.0200	0.0150~0.0420	0.0115~0.0550	0.0150~0.1000
			Vc	22~28	22~29	23~29	20~25	20~26	20~26	23~30
			fz	0.016~0.014	0.017~0.015	0.024~0.021	0.032~0.029	0.037~0.033	0.047~0.042	0.056~0.051
			RPM	14200~18000	11900~15500	9000~11700	6300~8050	5400~7000	4300~5500	3600~4700
			FEED	115~130	100~120	110~125	100~115	100~115	100~115	100~120
	39.1 - 39.3	Chilled Cast Iron	Ap	0.016~0.014	0.017~0.015	0.024~0.021	0.032~0.029	0.037~0.033	0.047~0.042	0.056~0.051
			Vc	40~52	39~66	41~66	39~59	39~66	43~83	40~66
			fz	0.006~0.009	0.005~0.013	0.007~0.018	0.009~0.022	0.010~0.028	0.012~0.046	0.016~0.045
			RPM	25650~33000	20900~35200	16150~26400	12300~18700	10450~17600	9100~17600	6350~10550
			FEED	370~470	330~560	360~590	350~540	350~590	430~830	340~570
			Ap	0.0056~0.0350	0.0063~0.0294	0.0084~0.0392	0.0105~0.0280	0.0245~0.0700	0.0161~0.0770	0.0210~0.1400
40	Hardened Cast Iron	Vc	37~41	38~41	38~42	33~36	34~38	33~38	38~42	
		fz	0.005~0.007	0.004~0.007	0.006~0.010	0.008~0.013	0.009~0.015	0.011~0.020	0.015~0.025	
		RPM	23750~26000	19900~22000	15200~16700	10500~11500	9100~10000	7000~8000	6100~6700	
		FEED	285~315	190~290	210~310	190~280	180~280	180~280	200~300	
		Ap	0.0040~0.0250	0.0450~0.0210	0.0060~0.0280	0.0075~0.0200	0.0150~0.0420	0.0115~0.0550	0.0150~0.1000	
		Vc	37~41	38~41	38~42	33~36	34~38	33~38	38~42	
41	Hardened Cast Iron	fz	0.005~0.007	0.004~0.007	0.006~0.010	0.008~0.013	0.009~0.015	0.011~0.020	0.015~0.025	
		RPM	23750~26000	19900~22000	15200~16700	10500~11500	9100~10000	7000~8000	6100~6700	
		FEED	285~315	190~290	210~310	190~280	180~280	180~280	200~300	
		Ap	0.0040~0.0250	0.0450~0.0210	0.0060~0.0280	0.0075~0.0200	0.0150~0.0420	0.0115~0.0550	0.0150~0.1000	
		Vc	37~41	38~41	38~42	33~36	34~38	33~38	38~42	
		fz	0.005~0.007	0.004~0.007	0.006~0.010	0.008~0.013	0.009~0.015	0.011~0.020	0.015~0.025	

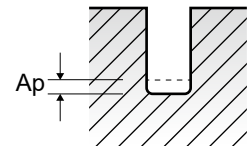

G8A50 SERIES
2 FLUTE CORNER RADIUS - SLOTTING

Vc = m/min.
fz = mm/tooth
RPM = rev./min.
FEED = mm/min.

ISO	VDI 3323	Material Description	Ae	Ap	Parameter	Diameter (Ø)								
						0.3	0.4	0.5	0.6	0.8	1.0	1.2	1.5	2.0
P	5	Non-alloy steel	1.0D	0.05D	Vc	45	65	80	95	125	150	160	175	210
					fz	0.002	0.002	0.004	0.005	0.006	0.008	0.009	0.011	0.013
					RPM	47746	51725	50930	50399	49736	47746	42441	37136	33423
					FEED	191	207	407	504	597	764	764	817	869
	8-9	Low alloy steel	1.0D	0.05D	Vc	45	65	80	95	125	150	160	175	210
					fz	0.002	0.002	0.004	0.005	0.006	0.008	0.009	0.011	0.013
					RPM	47746	51725	50930	50399	49736	47746	42441	37136	33423
					FEED	191	207	407	504	597	764	764	817	869
	11.1	High alloyed steel, and tool steel	1.0D	0.05D	Vc	45	65	80	95	125	150	160	175	210
					fz	0.002	0.002	0.004	0.005	0.006	0.008	0.009	0.011	0.013
					RPM	47746	51725	50930	50399	49736	47746	42441	37136	33423
					FEED	191	207	407	504	597	764	764	817	869
11.2	High alloyed steel, and tool steel	1.0D	0.05D	Vc	40	55	70	85	100	120	130	145	165	
				fz	0.002	0.002	0.003	0.004	0.006	0.008	0.009	0.011	0.013	
				RPM	42441	43768	44563	45094	39789	38197	34484	30770	26261	
				FEED	170	175	267	361	477	611	621	677	683	
H	38.1	Hardened steel	1.0D	0.05D	Vc	40	55	70	85	100	120	130	145	165
					fz	0.002	0.002	0.003	0.004	0.006	0.008	0.009	0.011	0.013
					RPM	42441	43768	44563	45094	39789	38197	34484	30770	26261
					FEED	170	175	267	361	477	611	621	677	683
	38.2	Hardened steel	1.0D	0.05D	Vc	40	50	65	75	75	80	85	100	110
					fz	0.001	0.002	0.003	0.004	0.005	0.007	0.008	0.01	0.012
					RPM	42441	39789	41380	39789	29842	25465	22547	21221	17507
					FEED	85	159	248	318	298	357	361	424	420
	39.1	Hardened steel	1.0D	0.02D	Vc	30	40	50	55	65	65	75	80	90
					fz	0.001	0.001	0.002	0.003	0.004	0.005	0.006	0.007	0.009
					RPM	31831	31831	31831	29178	25863	20690	19894	16977	14324
					FEED	64	64	127	175	207	207	239	238	258
	39.2	Hardened steel	1.0D	0.02D	Vc	25	30	40	45	50	50	55	60	70
					fz	0.001	0.001	0.002	0.002	0.003	0.004	0.005	0.006	0.007
					RPM	26526	23873	25465	23873	19894	15915	14589	12732	11141
					FEED	53	48	102	95	119	127	146	153	156
	40	Chilled Cast Iron	1.0D	0.05D	Vc	40	55	70	85	100	120	130	145	165
					fz	0.002	0.002	0.003	0.004	0.006	0.008	0.009	0.011	0.013
RPM					42441	43768	44563	45094	39789	38197	34484	30770	26261	
FEED					170	175	267	361	477	611	621	677	683	
41	Hardened Cast Iron	1.0D	0.05D	Vc	40	50	65	75	75	80	85	100	110	
				fz	0.001	0.002	0.003	0.004	0.005	0.007	0.008	0.01	0.012	
				RPM	42441	39789	41380	39789	29842	25465	22547	21221	17507	
				FEED	85	159	248	318	298	357	361	424	420	

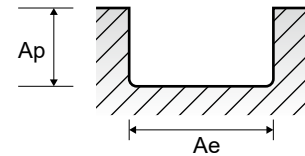



RECOMMENDED CUTTING CONDITIONS
EMPFOLGENE SCHNEIDPARAMETER

G8A47, G8B08 SERIES

4 FLUTE CORNER RADIUS - SIDE CUTTING

Vc = m/min.
fz = mm/tooth
RPM = rev./min.
FEED = mm/min.

ISO	VDI 3323	Material Description	Ae	Ap	Parameter	Diameter (Ø)										
						1.0	2.0	3.0	4.0	5.0	6.0	8.0	10.0	12.0	16.0	20.0
P	5	Non-alloy steel	0.03D	1.0D	Vc	150	210	205	210	245	245	250	245	250	245	245
					fz	0.006	0.011	0.016	0.022	0.025	0.03	0.038	0.045	0.053	0.061	0.067
					RPM	47746	33423	21751	16711	15597	12998	9947	7799	6631	4874	3899
					FEED	1146	1471	1392	1471	1560	1560	1512	1404	1406	1189	1045
	8-9	Low alloy steel	0.03D	1.0D	Vc	150	210	205	210	245	245	250	245	250	245	245
					fz	0.006	0.011	0.016	0.022	0.025	0.03	0.038	0.045	0.053	0.061	0.067
					RPM	47746	33423	21751	16711	15597	12998	9947	7799	6631	4874	3899
					FEED	1146	1471	1392	1471	1560	1560	1512	1404	1406	1189	1045
	11.1	High alloyed steel, and tool steel	0.03D	1.0D	Vc	150	210	205	210	245	245	250	245	250	245	245
					fz	0.006	0.011	0.016	0.022	0.025	0.03	0.038	0.045	0.053	0.061	0.067
					RPM	47746	33423	21751	16711	15597	12998	9947	7799	6631	4874	3899
					FEED	1146	1471	1392	1471	1560	1560	1512	1404	1406	1189	1045
11.2		0.03D	1.0D	Vc	120	165	165	165	195	195	195	195	200	195	195	
				fz	0.006	0.01	0.014	0.02	0.024	0.027	0.035	0.041	0.048	0.056	0.063	
				RPM	38197	26261	17507	13130	12414	10345	7759	6207	5305	3879	3104	
				FEED	917	1050	980	1050	1192	1117	1086	1018	1019	869	782	
H	38.1		0.03D	1.0D	Vc	120	165	165	165	195	195	195	195	200	195	195
					fz	0.006	0.01	0.014	0.02	0.024	0.027	0.035	0.041	0.048	0.056	0.063
					RPM	38197	26261	17507	13130	12414	10345	7759	6207	5305	3879	3104
					FEED	917	1050	980	1050	1192	1117	1086	1018	1019	869	782
	38.2		0.03D	1.0D	Vc	80	110	110	110	130	130	130	130	130	130	130
					fz	0.006	0.01	0.015	0.02	0.024	0.028	0.035	0.041	0.048	0.056	0.063
					RPM	25465	17507	11671	8754	8276	6897	5173	4138	3448	2586	2069
					FEED	611	700	700	700	794	772	724	679	662	579	521
	39.1	Hardened steel	0.03D	1.0D	Vc	65	90	90	90	100	100	100	100	100	100	100
					fz	0.004	0.007	0.011	0.015	0.018	0.021	0.026	0.03	0.036	0.042	0.048
					RPM	20690	14324	9549	7162	6366	5305	3979	3183	2653	1989	1592
					FEED	331	401	420	430	458	446	414	382	382	334	306
39.2		0.03D	1.0D	Vc	50	70	70	70	80	80	80	80	80	80	80	
				fz	0.003	0.006	0.009	0.012	0.015	0.017	0.021	0.024	0.029	0.034	0.038	
				RPM	15915	11141	7427	5570	5093	4244	3183	2546	2122	1592	1273	
				FEED	191	267	267	267	306	289	267	244	246	217	193	
39.3		0.03D	1.0D	Vc	40	60	60	60	70	70	70	70	70	70	70	
				fz	0.003	0.005	0.007	0.01	0.012	0.014	0.017	0.02	0.024	0.029	0.033	
				RPM	12732	9549	6366	4775	4456	3714	2785	2228	1857	1393	1114	
				FEED	153	191	178	191	214	208	189	178	178	162	147	
40	Chilled Cast Iron	0.03D	1.0D	Vc	120	165	165	165	195	195	195	195	200	195	195	
				fz	0.006	0.01	0.014	0.02	0.024	0.027	0.035	0.041	0.048	0.056	0.063	
				RPM	38197	26261	17507	13130	12414	10345	7759	6207	5305	3879	3104	
				FEED	917	1050	980	1050	1192	1117	1086	1018	1019	869	782	
41	Hardened Cast Iron	0.03D	1.0D	Vc	80	110	110	110	130	130	130	130	130	130	130	
				fz	0.006	0.01	0.015	0.02	0.024	0.028	0.035	0.041	0.048	0.056	0.063	
				RPM	25465	17507	11671	8754	8276	6897	5173	4138	3448	2586	2069	
				FEED	611	700	700	700	794	772	724	679	662	579	521	

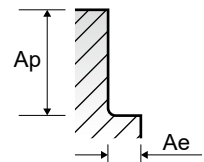

G8A45 SERIES

2 FLUTE for RIB PROCESSING - SLOTTING

Vc = m/min.
fz = mm/tooth
RPM = rev./min.
FEED = mm/min.

ISO	VDI 3323	Material Description	Parameter	Diameter (Ø)					
				0.2	0.3	0.4	0.5	0.6	0.8
P	5	Non-alloy steel	Vc	31	41~47	39~63	40~52	39~66	41~66
			fz	0.003~0.004	0.004~0.004	0.006~0.006	0.007~0.007	0.008~0.008	0.011~0.011
			RPM	50000	43000~50000	31400~50000	25650~33000	20900~35200	16150~26400
			FEED	300~350	330~420	350~590	370~470	330~560	360~590
	8-9	Low alloy steel	Vc	31	41~47	39~63	40~52	39~66	41~66
			fz	0.003~0.004	0.004~0.004	0.006~0.006	0.007~0.007	0.008~0.008	0.011~0.011
			RPM	50000	43000~50000	31400~50000	25650~33000	20900~35200	16150~26400
			FEED	300~350	330~420	350~590	370~470	330~560	360~590
	11.1 - 11.2	High alloyed steel, and tool steel	Vc	31	41~47	39~63	40~52	39~66	41~66
			fz	0.003~0.004	0.004~0.004	0.006~0.006	0.007~0.007	0.008~0.008	0.011~0.011
			RPM	50000	43000~50000	31400~50000	25650~33000	20900~35200	16150~26400
			FEED	300~350	330~420	350~590	370~470	330~560	360~590
H	38.1 - 38.2	Hardened steel	Vc	31	38~44	38~44	37~41	38~41	38~42
			fz	0.003~0.003	0.003~0.003	0.005~0.005	0.006~0.006	0.007~0.007	0.009~0.009
			RPM	50000	39900~46200	30500~35200	23750~26000	19900~22000	15200~16700
			FEED	265~310	265~310	295~340	285~315	260~290	280~310
	39.1 - 39.2	Hardened steel	Vc	31	23~30	23~31	22~28	22~29	23~29
			fz	0.002~0.003	0.002~0.003	0.003~0.004	0.004~0.004	0.004~0.004	0.006~0.005
			RPM	50000	23900~32300	18300~24600	14200~18000	11900~15500	9000~11700
			FEED	225~265	105~185	120~200	115~130	100~120	110~125
	40	Chilled Cast Iron	Vc	31	41~47	39~63	40~52	39~66	41~66
			fz	0.003~0.004	0.004~0.004	0.006~0.006	0.007~0.007	0.008~0.008	0.011~0.011
			RPM	50000	43000~50000	31400~50000	25650~33000	20900~35200	16150~26400
			FEED	300~350	330~420	350~590	370~470	330~560	360~590
41	Hardened Cast Iron	Vc	31	38~44	38~44	37~41	38~41	38~42	
		fz	0.003~0.003	0.003~0.003	0.005~0.005	0.006~0.006	0.007~0.007	0.009~0.009	
		RPM	50000	39900~46200	30500~35200	23750~26000	19900~22000	15200~16700	
		FEED	265~310	265~310	295~340	285~315	260~290	280~310	
				Ap					
				0.006~0.016	0.006~0.015	0.005~0.028	0.006~0.035	0.007~0.030	0.009~0.040
				0.006~0.016	0.006~0.015	0.005~0.028	0.006~0.035	0.007~0.030	0.009~0.040
				0.006~0.016	0.006~0.015	0.005~0.028	0.006~0.035	0.007~0.030	0.009~0.040
				0.005~0.013	0.004~0.011	0.003~0.020	0.004~0.025	0.005~0.021	0.006~0.028
				0.005~0.013	0.004~0.011	0.003~0.020	0.004~0.025	0.005~0.021	0.006~0.028
				0.005~0.013	0.004~0.011	0.003~0.020	0.004~0.025	0.005~0.021	0.006~0.028
				0.005~0.013	0.004~0.011	0.003~0.020	0.004~0.025	0.005~0.021	0.006~0.028

▶ NEXT PAGE

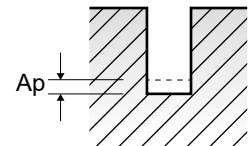



RECOMMENDED CUTTING CONDITIONS
EMPFOHLENE SCHNEIDPARAMETER

G8A45 SERIES

2 FLUTE for RIB PROCESSING - SLOTTING

Vc = m/min.
fz = mm/tooth
RPM = rev./min.
FEED = mm/min.

ISO	VDI 3323	Material Description	Parameter	Diameter (Ø)					
				1.0	1.2	1.5	2.0	3.0	4.0
P	5	Non-alloy steel	Vc	39~59	39~66	43~83	40~66	41~66	40~67
			fz	0.014~0.014	0.017~0.017	0.024~0.024	0.027~0.027	0.064~0.064	0.063~0.064
			RPM	12300~18700	10450~17600	9100~17600	6350~10550	4300~7050	3200~5300
			FEED	350~540	350~590	430~830	340~570	550~900	400~675
			Ap	0.011~0.028	0.025~0.070	0.017~0.077	0.021~0.140	0.056~0.210	0.074~0.280
			Ap	0.011~0.028	0.025~0.070	0.017~0.077	0.021~0.140	0.056~0.210	0.074~0.280
	8-9	Low alloy steel	Vc	39~59	39~66	43~83	40~66	41~66	40~67
			fz	0.014~0.014	0.017~0.017	0.024~0.024	0.027~0.027	0.064~0.064	0.063~0.064
			RPM	12300~18700	10450~17600	9100~17600	6350~10550	4300~7050	3200~5300
			FEED	350~540	350~590	430~830	340~570	550~900	400~675
			Ap	0.011~0.028	0.025~0.070	0.017~0.077	0.021~0.140	0.056~0.210	0.074~0.280
			Ap	0.011~0.028	0.025~0.070	0.017~0.077	0.021~0.140	0.056~0.210	0.074~0.280
11.1 - 11.2	High alloyed steel, and tool steel	Vc	39~59	39~66	43~83	40~66	41~66	40~67	
		fz	0.014~0.014	0.017~0.017	0.024~0.024	0.027~0.027	0.064~0.064	0.063~0.064	
		RPM	12300~18700	10450~17600	9100~17600	6350~10550	4300~7050	3200~5300	
		FEED	350~540	350~590	430~830	340~570	550~900	400~675	
		Ap	0.011~0.028	0.025~0.070	0.017~0.077	0.021~0.140	0.056~0.210	0.074~0.280	
		Ap	0.011~0.028	0.025~0.070	0.017~0.077	0.021~0.140	0.056~0.210	0.074~0.280	
H	38.1 - 38.2	Hardened steel	Vc	33~36	34~38	33~38	38~42	38~43	38~43
			fz	0.012~0.012	0.014~0.014	0.018~0.018	0.022~0.022	0.056~0.056	0.056~0.056
			RPM	10500~11500	9100~10000	7000~8000	6100~6700	3990~4600	3000~3400
			FEED	250~280	250~280	250~280	270~300	445~515	335~380
			Ap	0.008~0.020	0.015~0.042	0.012~0.055	0.015~0.100	0.040~0.150	0.053~0.200
			Ap	0.008~0.020	0.015~0.042	0.012~0.055	0.015~0.100	0.040~0.150	0.053~0.200
	39.1 - 39.2	Hardened steel	Vc	20~25	20~26	20~26	23~30	23~30	23~30
			fz	0.008~0.007	0.009~0.008	0.012~0.01	0.014~0.013	0.022~0.048	0.021~0.048
			RPM	6300~8050	5400~7000	4300~5500	3600~4700	2400~3200	1800~2400
			FEED	100~115	100~115	100~115	100~120	105~310	75~230
			Ap	0.005~0.012	0.009~0.026	0.007~0.033	0.009~0.060	0.024~0.090	0.032~0.120
			Ap	0.005~0.012	0.009~0.026	0.007~0.033	0.009~0.060	0.024~0.090	0.032~0.120
40	Chilled Cast Iron	Vc	39~59	39~66	43~83	40~66	41~66	40~67	
		fz	0.014~0.014	0.017~0.017	0.024~0.024	0.027~0.027	0.064~0.064	0.063~0.064	
		RPM	12300~18700	10450~17600	9100~17600	6350~10550	4300~7050	3200~5300	
		FEED	350~540	350~590	430~830	340~570	550~900	400~675	
		Ap	0.011~0.028	0.025~0.070	0.017~0.077	0.021~0.140	0.056~0.210	0.074~0.280	
		Ap	0.011~0.028	0.025~0.070	0.017~0.077	0.021~0.140	0.056~0.210	0.074~0.280	
41	Hardened Cast Iron	Vc	33~36	34~38	33~38	38~42	38~43	38~43	
		fz	0.012~0.012	0.014~0.014	0.018~0.018	0.022~0.022	0.056~0.056	0.056~0.056	
		RPM	10500~11500	9100~10000	7000~8000	6100~6700	3990~4600	3000~3400	
		FEED	250~280	250~280	250~280	270~300	445~515	335~380	
		Ap	0.008~0.020	0.015~0.042	0.012~0.055	0.015~0.100	0.040~0.150	0.053~0.200	
		Ap	0.008~0.020	0.015~0.042	0.012~0.055	0.015~0.100	0.040~0.150	0.053~0.200	

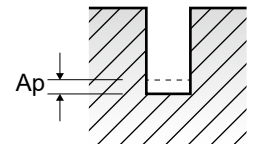

G8A01, G8A36 SERIES

2 FLUTE - SLOTTING

Vc = m/min.
fz = mm/tooth
RPM = rev./min.
FEED = mm/min.

ISO	VDI 3323	Material Description	Ae	Ap	Parameter	Diameter (Ø)									
						0.2	0.3	0.4	0.5	0.6	0.8	0.9	1.0	2.0	
P	5	Non-alloy steel	1.0D	0.05D	Vc	30	45	65	80	95	125	140	150	210	
					fz	0.001	0.002	0.002	0.004	0.005	0.006	0.007	0.01	0.013	
					RPM	47746	47746	51725	50930	50399	49736	49515	47746	33423	
					FEED	95	191	207	407	504	597	693	955	869	
	8-9	Low alloy steel	1.0D	0.05D	Vc	30	45	65	80	95	125	140	150	210	
					fz	0.001	0.002	0.002	0.004	0.005	0.006	0.007	0.01	0.013	
					RPM	47746	47746	51725	50930	50399	49736	49515	47746	33423	
					FEED	95	191	207	407	504	597	693	955	869	
	11.1	High alloyed steel, and tool steel	1.0D	0.05D	Vc	30	45	65	80	95	125	140	150	210	
					fz	0.001	0.002	0.002	0.004	0.005	0.006	0.007	0.01	0.013	
					RPM	47746	47746	51725	50930	50399	49736	49515	47746	33423	
					FEED	95	191	207	407	504	597	693	955	869	
11.2	High alloyed steel, and tool steel	1.0D	0.05D	Vc	30	40	55	70	85	100	110	120	165		
				fz	0.001	0.002	0.002	0.003	0.004	0.006	0.007	0.008	0.013		
				RPM	47746	42441	43768	44563	45094	39789	38905	38197	26261		
				FEED	95	170	175	267	361	477	545	611	683		
H	38.1	Hardened steel	1.0D	0.05D	Vc	30	40	55	70	85	100	110	120	165	
					fz	0.001	0.002	0.002	0.003	0.004	0.006	0.007	0.008	0.013	
					RPM	47746	42441	43768	44563	45094	39789	38905	38197	26261	
					FEED	95	170	175	267	361	477	545	611	683	
	38.2	Hardened steel	1.0D	0.05D	Vc	25	40	50	65	75	75	80	80	110	
					fz	0.001	0.001	0.002	0.003	0.004	0.005	0.006	0.007	0.012	
					RPM	39789	42441	39789	41380	39789	29842	28294	25465	17507	
					FEED	80	85	159	248	318	298	340	357	420	
	39.1	Hardened steel	1.0D	0.05D	Vc	20	30	40	50	55	65	65	65	90	
					fz	0.001	0.001	0.001	0.002	0.003	0.004	0.005	0.005	0.009	
					RPM	31831	31831	31831	31831	29178	25863	22989	20690	14324	
					FEED	64	64	64	127	175	207	230	207	258	
	39.2	Hardened steel	1.0D	0.05D	Vc	20	25	30	40	45	50	50	50	70	
					fz	0.001	0.001	0.001	0.002	0.002	0.003	0.004	0.004	0.007	
					RPM	31831	26526	23873	25465	23873	19894	17684	15915	11141	
					FEED	64	53	48	102	95	119	141	127	156	
	39.3	Hardened steel	1.0D	0.02D	Vc	15	20	25	30	40	40	40	40	60	
					fz	0.001	0.001	0.001	0.002	0.002	0.003	0.003	0.003	0.006	
					RPM	23873	21221	19894	19099	21221	15915	14147	12732	9549	
					FEED	29	38	40	57	81	83	91	87	116	
	40	Chilled Cast Iron	1.0D	0.05D	Vc	30	40	55	70	85	100	110	120	165	
					fz	0.001	0.002	0.002	0.003	0.004	0.006	0.007	0.008	0.013	
					RPM	47746	42441	43768	44563	45094	39789	38905	38197	26261	
					FEED	95	170	175	267	361	477	545	611	683	
41	Hardened Cast Iron	1.0D	0.05D	Vc	25	40	50	65	75	75	80	80	110		
				fz	0.001	0.001	0.002	0.003	0.004	0.005	0.006	0.007	0.012		
				RPM	39789	42441	39789	41380	39789	29842	28294	25465	17507		
				FEED	80	85	159	248	318	298	340	357	420		

▶ NEXT PAGE

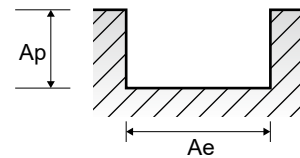



RECOMMENDED CUTTING CONDITIONS
EMPFOHLENE SCHNEIDPARAMETER

G8A01, G8A36 SERIES 2 FLUTE - SLOTTING

Vc = m/min.
fz = mm/tooth
RPM = rev./min.
FEED = mm/min.

ISO	VDI 3323	Material Description	Ae	Ap	Parameter	Diameter (Ø)									
						3.0	4.0	5.0	6.0	8.0	10.0	12.0	16.0	20.0	
P	5	Non-alloy steel	1.0D	0.05D	Vc	205	210	245	245	250	245	250	245	245	
					fz	0.019	0.026	0.032	0.036	0.047	0.054	0.064	0.074	0.085	
					RPM	21751	16711	15597	12998	9947	7799	6631	4874	3899	
	8-9	Low alloy steel	1.0D	0.05D	Vc	205	210	245	245	250	245	250	245	245	
					fz	0.019	0.026	0.032	0.036	0.047	0.054	0.064	0.074	0.085	
					RPM	21751	16711	15597	12998	9947	7799	6631	4874	3899	
	11.1	High alloyed steel, and tool steel	1.0D	0.05D	Vc	205	210	245	245	250	245	250	245	245	
					fz	0.019	0.026	0.032	0.036	0.047	0.054	0.064	0.074	0.085	
					RPM	21751	16711	15597	12998	9947	7799	6631	4874	3899	
	11.2		1.0D	0.05D	Vc	165	165	195	195	195	195	200	195	195	
					fz	0.02	0.027	0.032	0.037	0.046	0.055	0.065	0.074	0.085	
					RPM	17507	13130	12414	10345	7759	6207	5305	3879	3104	
H	38.1		1.0D	0.05D	Vc	165	165	195	195	195	195	200	195	195	
					fz	0.02	0.027	0.032	0.037	0.046	0.055	0.065	0.074	0.085	
					RPM	17507	13130	12414	10345	7759	6207	5305	3879	3104	
	38.2		1.0D	0.05D	Vc	110	110	130	130	130	130	130	130	130	
					fz	0.018	0.025	0.03	0.035	0.043	0.051	0.059	0.07	0.082	
					RPM	11671	8754	8276	6897	5173	4138	3448	2586	2069	
	39.1	Hardened steel	1.0D	0.05D	Vc	90	90	100	100	100	100	100	100	100	
					fz	0.014	0.019	0.022	0.026	0.032	0.038	0.045	0.053	0.061	
					RPM	9549	7162	6366	5305	3979	3183	2653	1989	1592	
	39.2		1.0D	0.05D	Vc	70	70	80	80	80	80	80	80	80	
					fz	0.011	0.015	0.018	0.021	0.026	0.03	0.037	0.042	0.048	
					RPM	7427	5570	5093	4244	3183	2546	2122	1592	1273	
39.3		1.0D	0.02D	Vc	60	60	70	70	70	70	70	70	70		
				fz	0.009	0.012	0.015	0.018	0.021	0.026	0.03	0.034	0.039		
				RPM	6366	4775	4456	3714	2785	2228	1857	1393	1114		
40	Chilled Cast Iron	1.0D	0.05D	Vc	165	165	195	195	195	195	200	195	195		
				fz	0.02	0.027	0.032	0.037	0.046	0.055	0.065	0.074	0.085		
				RPM	17507	13130	12414	10345	7759	6207	5305	3879	3104		
41	Hardened Cast Iron	1.0D	0.05D	Vc	110	110	130	130	130	130	130	130	130		
				fz	0.018	0.025	0.03	0.035	0.043	0.051	0.059	0.07	0.082		
				RPM	11671	8754	8276	6897	5173	4138	3448	2586	2069		

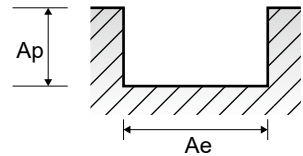

G8A01, G8A36 SERIES **2 FLUTE - SIDE CUTTING**

Vc = m/min.
fz = mm/tooth
RPM = rev./min.
FEED = mm/min.

ISO	VDI 3323	Material Description	Ae	Ap	Parameter	Diameter (Ø)										
						1.0	2.0	3.0	4.0	5.0	6.0	8.0	10.0	12.0	16.0	20.0
P	5	Non-alloy steel	0.03D	1.0D	Vc	150	210	205	210	245	245	250	245	250	245	245
					fz	0.011	0.018	0.028	0.037	0.046	0.052	0.067	0.077	0.09	0.107	0.122
					RPM	47746	33423	21751	16711	15597	12998	9947	7799	6631	4874	3899
					FEED	1050	1203	1218	1237	1435	1352	1333	1201	1194	1043	951
	8-9	Low alloy steel	0.03D	1.0D	Vc	150	210	205	210	245	245	250	245	250	245	245
					fz	0.011	0.018	0.028	0.037	0.046	0.052	0.067	0.077	0.09	0.107	0.122
					RPM	47746	33423	21751	16711	15597	12998	9947	7799	6631	4874	3899
					FEED	1050	1203	1218	1237	1435	1352	1333	1201	1194	1043	951
	11.1	High alloyed steel, and tool steel	0.03D	1.0D	Vc	150	210	205	210	245	245	250	245	250	245	245
					fz	0.011	0.018	0.028	0.037	0.046	0.052	0.067	0.08	0.09	0.107	0.122
					RPM	47746	33423	21751	16711	15597	12998	9947	7799	6631	4874	3899
					FEED	1050	1203	1218	1237	1435	1352	1333	1248	1194	1043	951
11.2	High alloyed steel, and tool steel	0.03D	1.0D	Vc	120	165	165	165	195	195	195	195	200	195	195	
				fz	0.011	0.019	0.028	0.038	0.046	0.053	0.066	0.079	0.092	0.108	0.121	
				RPM	38197	26261	17507	13130	12414	10345	7759	6207	5305	3879	3104	
				FEED	840	998	980	998	1142	1097	1024	981	976	838	751	
H	38.1	Hardened steel	0.03D	1.0D	Vc	120	165	165	165	195	195	195	195	200	195	195
					fz	0.011	0.019	0.028	0.038	0.046	0.053	0.066	0.079	0.092	0.108	0.121
					RPM	38197	26261	17507	13130	12414	10345	7759	6207	5305	3879	3104
					FEED	840	998	980	998	1142	1097	1024	981	976	838	751
	38.2	Hardened steel	0.03D	1.0D	Vc	80	110	110	110	130	130	130	130	130	130	130
					fz	0.01	0.017	0.026	0.036	0.043	0.05	0.061	0.072	0.084	0.1	0.116
					RPM	25465	17507	11671	8754	8276	6897	5173	4138	3448	2586	2069
					FEED	509	595	607	630	712	690	631	596	579	517	480
	39.1	Hardened steel	0.03D	1.0D	Vc	65	90	90	90	100	100	100	100	100	100	100
					fz	0.008	0.013	0.019	0.027	0.032	0.038	0.046	0.053	0.064	0.075	0.086
					RPM	20690	14324	9549	7162	6366	5305	3979	3183	2653	1989	1592
					FEED	331	372	363	387	407	403	366	337	340	298	274
	39.2	Hardened steel	0.03D	1.0D	Vc	50	70	70	70	80	80	80	80	80	80	80
					fz	0.006	0.01	0.015	0.021	0.025	0.03	0.037	0.043	0.052	0.059	0.067
					RPM	15915	11141	7427	5570	5093	4244	3183	2546	2122	1592	1273
					FEED	191	223	223	234	255	255	236	219	221	188	171
	39.3	Hardened steel	0.03D	1.0D	Vc	40	60	60	60	70	70	70	70	70	70	70
					fz	0.005	0.009	0.013	0.018	0.021	0.025	0.03	0.036	0.043	0.05	0.057
					RPM	12732	9549	6366	4775	4456	3714	2785	2228	1857	1393	1114
					FEED	127	172	166	172	187	186	167	160	160	139	127
	40	Chilled Cast Iron	0.03D	1.0D	Vc	120	165	165	165	195	195	195	195	200	195	195
					fz	0.011	0.019	0.028	0.038	0.046	0.053	0.066	0.079	0.092	0.108	0.121
					RPM	38197	26261	17507	13130	12414	10345	7759	6207	5305	3879	3104
					FEED	840	998	980	998	1142	1097	1024	981	976	838	751
41	Hardened Cast Iron	0.03D	1.0D	Vc	80	110	110	110	130	130	130	130	130	130	130	
				fz	0.01	0.017	0.026	0.036	0.043	0.05	0.061	0.072	0.084	0.1	0.116	
				RPM	25465	17507	11671	8754	8276	6897	5173	4138	3448	2586	2069	
				FEED	509	595	607	630	712	690	631	596	579	517	480	

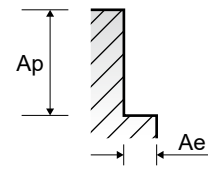

HSS

CBN END MILLS

i-Xmill END MILLS

i-SMART MODULAR END MILLS

X5070 END MILLS

4G MILL END MILLS

X-POWER PRO END MILLS

TitaNox-POWER END MILLS

JET-POWER END MILLS

V7 PLUS END MILLS

ALU-POWER HPC END MILLS

ALU-POWER END MILLS

D-POWER GRAPHITE END MILLS

D-POWER CFRP END MILLS

ROUTERS

CRX S END MILLS

K-2 END MILLS

ONLY ONE COATED PM60 END MILLS

TANK-POWER END MILLS

GENERAL HSS END MILLS

MILLING CUTTERS

TECHNICAL DATA



RECOMMENDED CUTTING CONDITIONS
EMPFOHLENE SCHNEIDPARAMETER

G8A02, G8A37 SERIES

4 FLUTE - SIDE CUTTING

Vc = m/min.
fz = mm/tooth
RPM = rev./min.
FEED = mm/min.

ISO	VDI 3323	Material Description	Ae	Ap	Parameter	Diameter (Ø)											
						1.0	2.0	3.0	4.0	5.0	6.0	8.0	10.0	12.0	16.0	20.0	
P	5	Non-alloy steel	0.03D	1.0D	Vc	150	210	205	210	245	245	250	245	250	245	245	
					fz	0.008	0.013	0.02	0.027	0.032	0.037	0.048	0.056	0.066	0.077	0.083	
					RPM	47746	33423	21751	16711	15597	12998	9947	7799	6631	4874	3899	
					FEED	1528	1738	1740	1805	1996	1924	1910	1747	1751	1501	1294	
P	8-9	Low alloy steel	0.03D	1.0D	Vc	150	210	205	210	245	245	250	245	250	245	245	
					fz	0.008	0.013	0.02	0.027	0.032	0.037	0.048	0.056	0.066	0.077	0.083	
					RPM	47746	33423	21751	16711	15597	12998	9947	7799	6631	4874	3899	
					FEED	1528	1738	1740	1805	1996	1924	1910	1747	1751	1501	1294	
P	11.1	High alloyed steel, and tool steel	0.03D	1.0D	Vc	150	210	205	210	245	245	250	245	250	245	245	
					fz	0.008	0.013	0.02	0.027	0.032	0.037	0.048	0.056	0.066	0.077	0.083	
					RPM	47746	33423	21751	16711	15597	12998	9947	7799	6631	4874	3899	
					FEED	1528	1738	1740	1805	1996	1924	1910	1747	1751	1501	1294	
P	11.2	High alloyed steel, and tool steel	0.03D	1.0D	Vc	120	165	165	165	195	195	195	195	200	195	195	
					fz	0.007	0.012	0.018	0.025	0.03	0.034	0.043	0.051	0.06	0.071	0.078	
					RPM	38197	26261	17507	13130	12414	10345	7759	6207	5305	3879	3104	
					FEED	1070	1261	1261	1313	1490	1407	1335	1266	1273	1102	968	
H	38.1	Hardened steel	0.03D	1.0D	Vc	120	165	165	165	195	195	195	195	200	195	195	
					fz	0.007	0.012	0.018	0.025	0.03	0.034	0.043	0.051	0.06	0.071	0.078	
					RPM	38197	26261	17507	13130	12414	10345	7759	6207	5305	3879	3104	
					FEED	1070	1261	1261	1313	1490	1407	1335	1266	1273	1102	968	
	H	38.2	Hardened steel	0.03D	1.0D	Vc	80	110	110	110	130	130	130	130	130	130	130
						fz	0.007	0.012	0.018	0.025	0.03	0.034	0.043	0.051	0.06	0.07	0.079
						RPM	25465	17507	11671	8754	8276	6897	5173	4138	3448	2586	2069
						FEED	713	840	840	875	993	938	890	844	828	724	654
	H	39.1	Hardened steel	0.03D	1.0D	Vc	65	90	90	90	100	100	100	100	100	100	100
						fz	0.005	0.009	0.014	0.019	0.023	0.026	0.033	0.038	0.045	0.053	0.059
						RPM	20690	14324	9549	7162	6366	5305	3979	3183	2653	1989	1592
						FEED	414	516	535	544	586	552	525	484	478	422	376
H	39.2	Hardened steel	0.03D	1.0D	Vc	50	70	70	70	80	80	80	80	80	80	80	
					fz	0.004	0.007	0.011	0.015	0.018	0.021	0.026	0.03	0.036	0.042	0.048	
					RPM	15915	11141	7427	5570	5093	4244	3183	2546	2122	1592	1273	
					FEED	255	312	327	334	367	356	331	306	306	267	244	
H	39.3	Hardened steel	0.03D	1.0D	Vc	40	60	60	60	70	70	70	70	70	70	70	
					fz	0.004	0.007	0.009	0.013	0.016	0.018	0.022	0.025	0.03	0.036	0.041	
					RPM	12732	9549	6366	4775	4456	3714	2785	2228	1857	1393	1114	
					FEED	204	267	229	248	285	267	245	223	223	201	183	
H	40	Chilled Cast Iron	0.03D	1.0D	Vc	120	165	165	165	195	195	195	195	200	195	195	
					fz	0.007	0.012	0.018	0.025	0.03	0.034	0.043	0.051	0.06	0.071	0.078	
					RPM	38197	26261	17507	13130	12414	10345	7759	6207	5305	3879	3104	
					FEED	1070	1261	1261	1313	1490	1407	1335	1266	1273	1102	968	
H	41	Hardened Cast Iron	0.03D	1.0D	Vc	80	110	110	110	130	130	130	130	130	130	130	
					fz	0.007	0.012	0.018	0.025	0.03	0.034	0.043	0.051	0.06	0.07	0.079	
					RPM	25465	17507	11671	8754	8276	6897	5173	4138	3448	2586	2069	
					FEED	713	840	840	875	993	938	890	844	828	724	654	

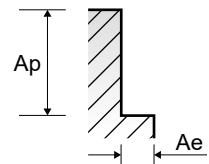

G8A39 SERIES

6 FLUTE - SIDE CUTTING

Vc = m/min.
fz = mm/tooth
RPM = rev./min.
FEED = mm/min.

ISO	VDI 3323	Material Description	Ae	Ap	Parameter	Diameter (Ø)					
						6.0	8.0	10.0	12.0	16.0	20.0
P	5	Non-alloy steel	0.05D	1.0D	Vc	120	121	121	122	121	121
					fz	0.039	0.052	0.063	0.07	0.09	0.079
					RPM	6366	4814	3852	3236	2407	1926
					FEED	1490	1502	1456	1359	1300	913
	8-9	Low alloy steel	0.05D	1.0D	Vc	120	121	121	122	121	121
					fz	0.039	0.052	0.063	0.07	0.09	0.079
					RPM	6366	4814	3852	3236	2407	1926
					FEED	1490	1502	1456	1359	1300	913
	11.1	High alloyed steel, and tool steel	0.05D	1.0D	Vc	120	121	121	122	121	121
					fz	0.039	0.052	0.063	0.07	0.09	0.079
					RPM	6366	4814	3852	3236	2407	1926
					FEED	1490	1502	1456	1359	1300	913
11.2	High alloyed steel, and tool steel	0.05D	1.0D	Vc	106	108	106	106	108	110	
				fz	0.036	0.049	0.058	0.065	0.083	0.095	
				RPM	5623	4297	3374	2812	2149	1751	
				FEED	1215	1263	1174	1097	1070	998	
H	38.1	Hardened steel	0.05D	1.0D	Vc	106	108	106	106	108	110
					fz	0.036	0.049	0.058	0.065	0.083	0.095
					RPM	5623	4297	3374	2812	2149	1751
					FEED	1215	1263	1174	1097	1070	998
	38.2	Hardened steel	0.05D	1.0D	Vc	95	97	94	95	97	98
					fz	0.035	0.046	0.055	0.062	0.079	0.091
					RPM	5040	3860	2992	2520	1930	1560
					FEED	1058	1065	987	937	915	852
	39.1	Hardened steel	0.03D	1.0D	Vc	83	83	82	83	83	87
					fz	0.033	0.044	0.053	0.059	0.076	0.072
					RPM	4403	3302	2610	2202	1651	1385
					FEED	872	872	830	780	753	598
	39.2	Hardened steel	0.03D	1.0D	Vc	72	72	72	72	72	75
					fz	0.031	0.042	0.05	0.056	0.072	0.069
					RPM	3820	2865	2292	1910	1432	1194
					FEED	711	722	688	642	619	494
	39.3	Hardened steel	0.03D	1.0D	Vc	48	48	49	50	48	45
					fz	0.028	0.037	0.045	0.05	0.064	0.071
					RPM	2546	1910	1560	1326	955	716
					FEED	428	424	421	398	367	305
	40	Chilled Cast Iron	0.05D	1.0D	Vc	106	108	106	106	108	110
					fz	0.036	0.049	0.058	0.065	0.083	0.095
					RPM	5623	4297	3374	2812	2149	1751
					FEED	1215	1263	1174	1097	1070	998
41	Hardened Cast Iron	0.05D	1.0D	Vc	95	97	94	95	97	98	
				fz	0.035	0.046	0.055	0.062	0.079	0.091	
				RPM	5040	3860	2992	2520	1930	1560	
				FEED	1058	1065	987	937	915	852	

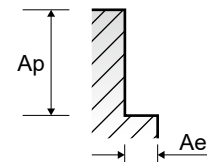



RECOMMENDED CUTTING CONDITIONS
EMPFOHLENE SCHNEIDPARAMETER

G8D63 SERIES

6&8 FLUTE LONG LENGTH - SIDE CUTTING

Vc = m/min.
fz = mm/tooth
RPM = rev./min.
FEED = mm/min.

ISO	VDI 3323	Material Description	Ae	Ap	Parameter	Diameter (Ø)								
						6.0	8.0	10.0	12.0	14.0	16.0	18.0	20.0	25.0
P	5	Non-alloy steel	0.04D	1.5D	Vc	120	120	120	120	120	120	120	120	125
					fz	0.039	0.052	0.063	0.07	0.081	0.09	0.095	0.08	0.11
					RPM	6366	4775	3820	3183	2728	2387	2122	1910	1592
					FEED	1490	1490	1444	1337	1326	1289	1613	1222	1401
	8-9	Low alloy steel	0.04D	1.5D	Vc	120	120	120	120	120	120	120	120	125
					fz	0.039	0.052	0.063	0.07	0.081	0.09	0.095	0.08	0.11
					RPM	6366	4775	3820	3183	2728	2387	2122	1910	1592
					FEED	1490	1490	1444	1337	1326	1289	1613	1222	1401
	11.1	High alloyed steel, and tool steel	0.04D	1.5D	Vc	120	120	120	120	120	120	120	120	125
					fz	0.039	0.052	0.063	0.07	0.081	0.09	0.095	0.08	0.11
					RPM	6366	4775	3820	3183	2728	2387	2122	1910	1592
					FEED	1490	1490	1444	1337	1326	1289	1613	1222	1401
11.2		0.04D	1.5D	Vc	95	95	95	95	95	95	95	100	95	
				fz	0.035	0.046	0.055	0.062	0.07	0.079	0.08	0.091	0.096	
				RPM	5040	3780	3024	2520	2160	1890	1680	1592	1210	
				FEED	1058	1043	998	937	907	896	1075	1159	929	
H	38.1 - 38.2		0.04D	1.5D	Vc	95	95	95	95	95	95	95	100	95
					fz	0.035	0.046	0.055	0.062	0.07	0.079	0.08	0.091	0.096
					RPM	5040	3780	3024	2520	2160	1890	1680	1592	1210
					FEED	1058	1043	998	937	907	896	1075	1159	929
	39.1 - 39.2	Hardened steel	0.04D	1.5D	Vc	70	70	70	70	70	70	70	75	75
					fz	0.031	0.042	0.05	0.056	0.066	0.072	0.073	0.069	0.087
					RPM	3714	2785	2228	1857	1592	1393	1238	1194	955
					FEED	691	702	668	624	630	602	723	659	665
	39.3		0.04D	1.5D	Vc	50	50	50	50	45	50	50	45	50
					fz	0.028	0.037	0.045	0.05	0.051	0.064	0.066	0.071	0.079
					RPM	2653	1989	1592	1326	1023	995	884	716	637
					FEED	446	442	430	398	313	382	467	407	403
40	Chilled Cast Iron	0.04D	1.5D	Vc	95	95	95	95	95	95	95	100	95	
				fz	0.035	0.046	0.055	0.062	0.07	0.079	0.08	0.091	0.096	
				RPM	5040	3780	3024	2520	2160	1890	1680	1592	1210	
				FEED	1058	1043	998	937	907	896	1075	1159	929	
41	Hardened Cast Iron	0.04D	1.5D	Vc	95	95	95	95	95	95	95	100	95	
				fz	0.035	0.046	0.055	0.062	0.07	0.079	0.08	0.091	0.096	
				RPM	5040	3780	3024	2520	2160	1890	1680	1592	1210	
				FEED	1058	1043	998	937	907	896	1075	1159	929	

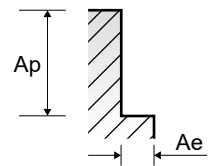

G8D64 SERIES
6&8 FLUTE EXTRA LONG LENGTH- SIDE CUTTING

Vc = m/min.
fz = mm/tooth
RPM = rev./min.
FEED = mm/min.

ISO	VDI 3323	Material Description	Ae	Ap	Parameter	Diameter (Ø)								
						6.0	8.0	10.0	12.0	14.0	16.0	18.0	20.0	25.0
P	5	Non-alloy steel	0.01D	3.0D	Vc	60	60	60	60	60	60	60	60	60
					fz	0.04	0.05	0.06	0.07	0.075	0.081	0.085	0.086	0.089
					RPM	3183	2387	1910	1592	1364	1194	1061	955	764
					FEED	764	716	688	669	614	580	721	657	544
	8-9	Low alloy steel	0.01D	3.0D	Vc	60	60	60	60	60	60	60	60	60
					fz	0.04	0.05	0.06	0.07	0.075	0.081	0.085	0.086	0.089
					RPM	3183	2387	1910	1592	1364	1194	1061	955	764
					FEED	764	716	688	669	614	580	721	657	544
	11.1	High alloyed steel, and tool steel	0.01D	3.0D	Vc	60	60	60	60	60	60	60	60	60
					fz	0.04	0.05	0.06	0.07	0.075	0.081	0.085	0.086	0.089
					RPM	3183	2387	1910	1592	1364	1194	1061	955	764
					FEED	764	716	688	669	614	580	721	657	544
11.2	High alloyed steel, and tool steel	0.01D	3.0D	Vc	60	60	60	60	60	60	60	60	60	
				fz	0.03	0.04	0.05	0.061	0.066	0.071	0.08	0.09	0.08	
				RPM	3183	2387	1910	1592	1364	1194	1061	955	764	
				FEED	573	573	573	583	540	509	679	688	489	
H	38.1 - 38.2	Hardened steel	0.01D	3.0D	Vc	60	60	60	60	60	60	60	60	60
					fz	0.03	0.04	0.05	0.061	0.066	0.071	0.08	0.09	0.08
					RPM	3183	2387	1910	1592	1364	1194	1061	955	764
					FEED	573	573	573	583	540	509	679	688	489
	39.1 - 39.2	Hardened steel	0.01D	3.0D	Vc	50	50	50	50	50	50	50	50	50
					fz	0.03	0.04	0.05	0.06	0.066	0.071	0.081	0.091	0.081
					RPM	2653	1989	1592	1326	1137	995	884	796	637
					FEED	478	477	478	477	450	424	573	579	413
	40	Chilled Cast Iron	0.01D	3.0D	Vc	60	60	60	60	60	60	60	60	60
					fz	0.03	0.04	0.05	0.061	0.066	0.071	0.08	0.09	0.08
					RPM	3183	2387	1910	1592	1364	1194	1061	955	764
					FEED	573	573	573	583	540	509	679	688	489
	41	Hardened Cast Iron	0.01D	3.0D	Vc	60	60	60	60	60	60	60	60	60
					fz	0.03	0.04	0.05	0.061	0.066	0.071	0.08	0.09	0.08
					RPM	3183	2387	1910	1592	1364	1194	1061	955	764
					FEED	573	573	573	583	540	509	679	688	489

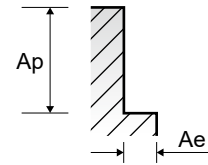



Global Cutting Tool Leader **YG-1**



MILLING



Leading Through Innovation



SOLID CARBIDE

4G Mill END MILLS

4G Mill VHM - FRÄSER

- High Speed Cutting for Pre-Hardened Steels up to HRc55
- Hochgeschwindigkeitsbearbeitung für vorvergehärtete Stähle bis HRc55

SELECTION GUIDE



SERIES	SEMD98	SEM846	SEM846	SEMD99
FLUTE	2	2	2	2
HELIX ANGLE	30°	30°	30°	30°
CUTTING EDGE SHAPE	BALL NOSE	BALL NOSE	BALL NOSE	CORNER RADIUS
SIZE MIN	R0.05	R0.05	R0.25	D0.2
SIZE MAX	R12.5	R6.0	R1.0	D20.0
PAGE	166	172	182	185

SOLID CARBIDE
4G Mill
END MILLS

High Speed Cutting
for Pre-Hardened Steels up to HRC55

-	EXTENDED NECK	EXTENDED NECK (6mm Shank)	-
Y-Coating	Y-Coating	Y-Coating	Y-Coating



Please visit
globalyg1.com/mat
for material search

◎ : Excellent ○ : Good

Recommended cutting conditions : P 276

ISO	VDI 3323	Material Description	Composition / Structure / Heat Treatment	HB	HRc	SEM98	SEM846	SEM846	SEMD99
P	1	Non-alloy steel	About 0.15% C Annealed	125		○	○	○	○
	2		About 0.45% C Annealed	190	13	○	○	○	○
	3		About 0.45% C Quenched & Tempered	250	25	○	○	○	◎
	4		About 0.75% C Annealed	270	28	◎	◎	◎	◎
	5		About 0.75% C Quenched & Tempered	300	32	◎	◎	◎	◎
	6	Low alloy steel	Annealed	180	10	○	○	○	○
	7		Quenched & Tempered	275	29	◎	◎	◎	◎
	8		Quenched & Tempered	300	32	◎	◎	◎	◎
	9		Quenched & Tempered	350	38	◎	◎	◎	◎
	10		High alloyed steel, and tool steel	Annealed	200	15	○	○	○
	11	Quenched & Tempered		325	35	◎	◎	◎	◎
M	12	Stainless steel	Ferritic / Martensitic Annealed	200	15				
	13		Martensitic Quenched & Tempered	240	23				
	14		Austenitic	180	10				
K	15	Grey cast iron	Pearlitic / ferritic	180	10	○	○	○	○
	16		Pearlitic (Martensitic)	260	26	○	○	○	○
	17	Nodular cast iron	Ferritic	160	3	○	○	○	○
	18		Pearlitic	250	25	○	○	○	○
	19	Malleable cast iron	Ferritic	130		○	○	○	○
20	Pearlitic		230	21	○	○	○	○	
N	21	Aluminum-wrought alloy	Not Curable	60					
	22		Curable Hardened	100					
	23	Aluminum-cast, alloyed	≤ 12% Si, Not Curable	75					
	24		≤ 12% Si, Curable Hardened	90					
	25		> 12% Si, Not Curable	130					
	26	Copper and Copper Alloys (Bronze / Brass)	Cutting Alloys, PB>1%	110					
	27		CuZn, CuSnZn (Brass)	90					
	28		CuSn, lead-free copper and electrolytic copper	100					
	29	Non Metallic Materials	Duroplastic, Fiber Reinforced Plastic						
	30		Rubber, Wood, etc.						
S	31	Heat Resistant Super Alloys	Fe Based	Annealed	200	15			
	32			Cured	280	30			
	33		Ni or Co Based	Annealed	250	25			
	34			Cured	350	38			
	35			Cast	320	34			
36	Titanium Alloys	Pure Titanium	400 Rm						
37		Alpha + Beta Alloys Hardened	1050 Rm						
H	38	Hardened steel	Hardened	550	55	○	○	○	○
	39		Hardened	630	60				
	40	Chilled Cast Iron	Cast	400	42	◎	◎	◎	◎
	41	Hardened Cast Iron	Hardened	550	55	○	○	○	○

SEME61	SEME01	SEME64	SEME35	SEME35	SEME35	SEME70	SEM845	SEME36	SEME71	SEME72	SEME73	SEME75
2	4	4	2	2	2	2	2	4	4	4	4	6
30°	27°/30° (MULTIPLE HELIX)	27°/30° (MULTIPLE HELIX)	30°	30°	30°	30°	30°	27°/30° (MULTIPLE HELIX)	35°/38° (MULTIPLE HELIX)	30°	30°	45°
CORNER RADIUS	CORNER RADIUS	CORNER RADIUS	SQUARE	SQUARE	SQUARE	SQUARE	SQUARE	SQUARE	SQUARE	SQUARE	SQUARE	SQUARE
D0.2	D1.0	D1.0	D0.1	D0.1	D0.1	D1.0	D0.1	D0.8	D1.0	D1.0	D1.0	D6.0
D20.0	D20.0	D20.0	D25.0	D4.0	D3.0	D25.0	D12.0	D25.0	D20.0	D25.0	D12.0	D20.0
193	212	219	234	237	238	239	245	254	256	260	266	271
EXTENDED NECK	-	EXTENDED NECK	-	4mm Shank	3mm Shank	LONG LENGTH	EXTENDED NECK	-	Sharp Corner Removal	LONG LENGTH	EXTENDED NECK	-
Y-Coating	Y-Coating	Y-Coating	Y-Coating	Y-Coating	Y-Coating	Y-Coating	Y-Coating	Y-Coating	Y-Coating	Y-Coating	Y-Coating	Y-Coating

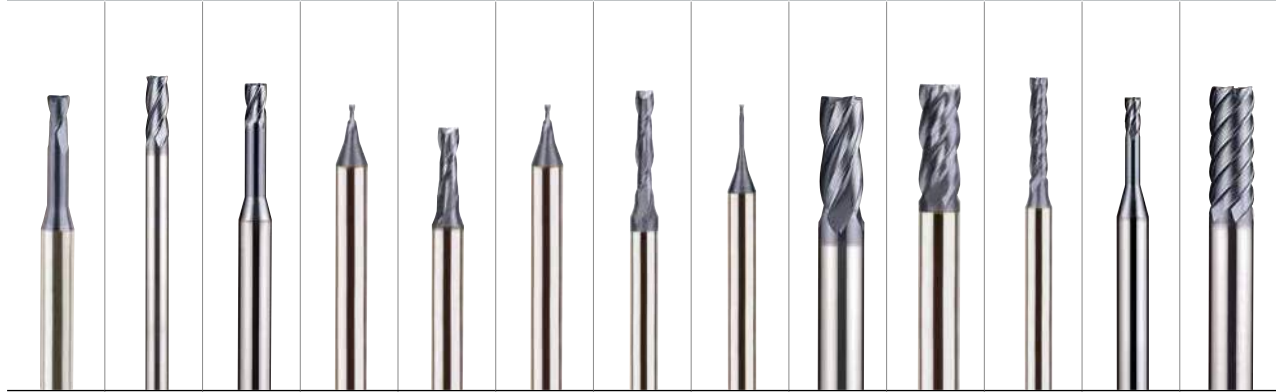

○	○	○	○	○	○	○	○	○	○	○	○	○	1
○	○	◎	○	○	○	○	○	○	○	○	○	○	2
◎	◎	◎	◎	◎	◎	◎	◎	◎	◎	◎	◎	◎	3
◎	◎	◎	◎	◎	◎	◎	◎	◎	◎	◎	◎	◎	4
◎	◎	◎	◎	◎	◎	◎	◎	◎	◎	◎	◎	◎	5
○	○	○	○	○	○	○	○	○	○	○	○	○	6 P
◎	◎	◎	◎	◎	◎	◎	◎	◎	◎	◎	◎	◎	7
◎	◎	◎	◎	◎	◎	◎	◎	◎	◎	◎	◎	◎	8
◎	◎	◎	◎	◎	◎	◎	◎	◎	◎	◎	◎	◎	9
○	○	○	○	○	○	○	○	○	○	○	○	○	10
◎	◎	◎	◎	◎	◎	◎	◎	◎	◎	◎	◎	◎	11
													12
													13 M
			○	○	○	○	○	○	○	○	○	○	14
○	○	○	○	○	○	○	○	○	○	○	○	○	15
○	○	○	○	○	○	○	○	○	○	○	○	○	16
○	○	○	○	○	○	○	○	○	○	○	○	○	17 K
○	○	○	○	○	○	○	○	○	○	○	○	○	18
○	○	○	○	○	○	○	○	○	○	○	○	○	19
○	○	○	○	○	○	○	○	○	○	○	○	○	20
													21
													22
													23
													24
													25 N
													26
													27
													28
													29
													30
													31
													32
													33
													34 S
													35
													36
													37
○	○	○	○	○	○	○	○	○	○	○	○	○	38
◎	◎	◎	◎	◎	◎	◎	◎	◎	◎	◎	◎	◎	39
○	○	○	○	○	○	○	○	○	○	○	○	○	40 H
													41

HSS

CBN END MILLS

i-Xmill END MILLS

i-SMART MODULAR END MILLS

X5070 END MILLS

4G MILL END MILLS

X-POWER PRO END MILLS

TitaNox-POWER END MILLS

JET-POWER END MILLS

V7 PLUS END MILLS

ALU-POWER HPC END MILLS

ALU-POWER END MILLS

D-POWER GRAPHITE END MILLS

D-POWER CFRP END MILLS

ROUTERS

CRX S END MILLS

K-2 END MILLS

ONLY ONE COATED PM60 END MILLS

TANK-POWER END MILLS

GENERAL HSS END MILLS

MILLING CUTTERS

TECHNICAL DATA

SELECTION GUIDE



SERIES	G9D75 G9D67	G9D76 G9D68	G9D77 G9D69	GAE53
FLUTE	4&5	4&5	4&5	4&5
HELIX ANGLE	44°~45° (MULTIPLE HELIX)	44°~45° (MULTIPLE HELIX)	44°~45° (MULTIPLE HELIX)	44°~45° (MULTIPLE HELIX)
CUTTING EDGE SHAPE	CORNER RADIUS ROUGHING	CORNER RADIUS ROUGHING	CORNER RADIUS ROUGHING	CORNER RADIUS ROUGHING
SIZE MIN	D6.0	D6.0	D6.0	D6.0
SIZE MAX	D20.0	D20.0	D20.0	D20.0
PAGE	273	273	274	275

HSS

CBN
END MILLS

i-Xmill
END MILLS

i-SMART
MODULAR
END MILLS

X5070
END MILLS

4G MILL
END MILLS

X-POWER
PRO
END MILLS

TitaNox-
POWER
END MILLS

JET-POWER
END MILLS

V7 PLUS
END MILLS

ALU-POWER
HPC
END MILLS

ALU-
POWER
END MILLS

D-POWER
GRAPHITE
END MILLS

D-POWER
CFRP
END MILLS

ROUTERS

CRX S
END MILLS

K-2
END MILLS

ONLY ONE
COATED PM60
END MILLS

TANK-
POWER
END MILLS

GENERAL
HSS
END MILLS

MILLING
CUTTERS

TECHNICAL
DATA

**SOLID CARBIDE
4G Mill
END MILLS**

X-SPEED ROUGHER

High Speed Cutting
for Pre-Hardened Steels up to HRc55



Please visit
globalyg1.com/mat
for material search

◎ : Excellent ○ : Good

Recommended cutting conditions : P 276

SHORT LENGTH	LONG LENGTH	LONG LENGTH	HSS-PM SHORT LENGTH
X-Coating	X-Coating	X-Coating	X-Coating



ISO	VDI 3323	Material Description	Composition / Structure / Heat Treatment	HB	HRc	G9D75 G9D67	G9D76 G9D68	G9D77 G9D69	GAE53
P	1	Non-alloy steel	About 0.15% C Annealed	125		○	○	○	○
	2		About 0.45% C Annealed	190	13	○	○	○	○
	3		About 0.45% C Quenched & Tempered	250	25	◎	◎	◎	◎
	4		About 0.75% C Annealed	270	28	◎	◎	◎	◎
	5		About 0.75% C Quenched & Tempered	300	32	◎	◎	◎	○
	6	Low alloy steel	Annealed	180	10	○	○	○	○
	7		Quenched & Tempered	275	29	◎	◎	◎	◎
	8		Quenched & Tempered	300	32	◎	◎	◎	○
	9		Quenched & Tempered	350	38	◎	◎	◎	○
	10		High alloyed steel, and tool steel	Annealed	200	15	○	○	○
	11	Quenched & Tempered		325	35	◎	◎	◎	○
M	12	Stainless steel	Ferritic / Martensitic Annealed	200	15	○	○	○	
	13		Martensitic Quenched & Tempered	240	23	○	○	○	
	14		Austenitic	180	10	○	○	○	◎
K	15	Grey cast iron	Pearlitic / ferritic	180	10	◎	◎	◎	◎
	16		Pearlitic (Martensitic)	260	26	◎	◎	◎	◎
	17	Nodular cast iron	Ferritic	160	3	◎	◎	◎	◎
	18		Pearlitic	250	25	◎	◎	◎	◎
	19		Ferritic	130		◎	◎	◎	◎
20	Malleable cast iron	Pearlitic	230	21	◎	◎	◎	◎	
N	21	Aluminum- wrought alloy	Not Curable	60					
	22		Curable Hardened	100					
	23	Aluminum-cast, alloyed	≤ 12% Si, Not Curable	75					
	24		≤ 12% Si, Curable Hardened	90					
	25		> 12% Si, Not Curable	130					
	26	Copper and Copper Alloys (Bronze / Brass)	Cutting Alloys, PB>1%	110		○	○	○	○
	27		CuZn, CuSnZn (Brass)	90		○	○	○	○
	28		CuSn, lead-free copper and electrolytic copper	100		○	○	○	○
	29	Non Metallic Materials	Duroplastic, Fiber Reinforced Plastic						
30	Rubber, Wood, etc.								
S	31	Heat Resistant Super Alloys	Fe Based	Annealed	200	15			
	32			Cured	280	30			
	33			Annealed	250	25			
	34		Ni or Co Based	Cured	350	38			
	35			Cast	320	34			
	36			Titanium Alloys	Pure Titanium	400 Rm			
37	Alpha + Beta Alloys Hardened	1050 Rm							
H	38	Hardened steel	Hardened	550	55				
	39			630	60				
	40	Chilled Cast Iron	Cast	400	42				
	41	Hardened Cast Iron	Hardened	550	55				

X-SPEED ROUGHER

CHARACTERISTICS

- Unique flute design for excellent chip evacuation and vibration reduction.
- Optimal roughing tooth profile to reduce cutting forces.
- Special tool geometry for high feed rate and heavy cutting.
- Strong end tooth design for plunge and pocket milling.
- Custom engineered coating to allow long tool life and excellent chip evacuation.

▶ 4 FLUTE



▶ 5 FLUTE

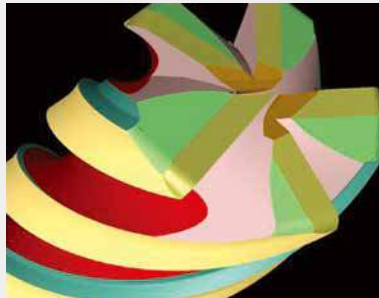

CHIP THICKNESS AND SHAPE

▶ Conventional Roughing End Mills

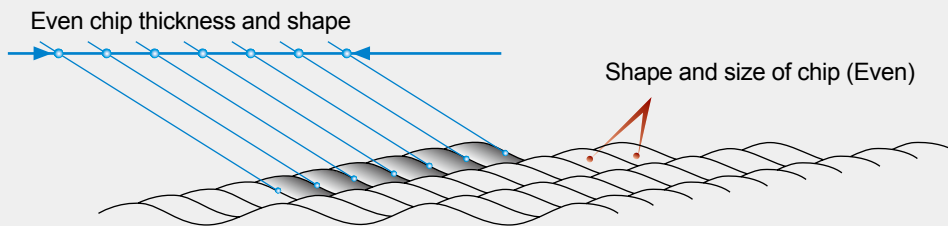

▶ X-SPEED Rougher

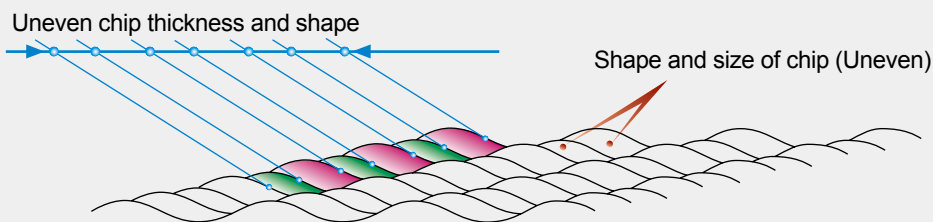

YG 4G MILL END MILLS

PLAIN SHANK

SEMD98 SERIES

CARBIDE, 2 FLUTE BALL NOSE (Short, Regular, Long Shank)

● **VOLLHARTMETALL, 2 SCHNEIDEN STIRNRADIUS**

● **Fraise carbure, 2 dents, hémisphérique**

● **MD, 2 TAGLIANTI, SEMISFERICA (Serie corta, media e lunga)**

- ▶ New coating and tool geometry applied resulting outstanding cutting abilities and wear resistance.
- ▶ With its unique ball nose geometry and cutting edges the cutting force has decreased, also increasing wear resistance.
- ▶ Excellent performance when cutting prehardened steels, up to HRc55 which are used for molds & dies.

- ▶ Aufgrund einer neuartigen Beschichtung und neuer Werkzeuggeometrien hervorragende Schnittleistung und Verschleißfestigkeit.
- ▶ Aufgrund der einzigartigen Kugelgeometrie und Schneidkantenpräparation wird die Schnittkraft reduziert und die Verschleißfestigkeit erhöht.
- ▶ Hervorragende Leistung bei der Zerspaltung von vorvergüteten Stählen bis HRc55, welche im Werkzeug- und Formenbau Verwendung finden.

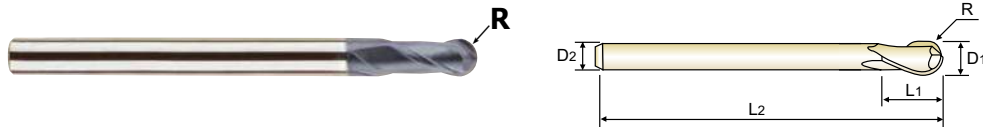

CARBIDE 2 30° R ±0.005 R ±0.010 PLAIN P.276-277

R0.05-R3 R325-R125

Unit : mm

EDP No.	Radius of Ball Nose	Mill Diameter	Shank Diameter	Length of Cut	Overall Length	Remark
	R	D1	D2	L1	L2	
★ SEMD98001SE	R0.05	0.1	4	0.1	40	Short
★ SEMD98001E	R0.05	0.1	4	0.2	40	Regular
SEMD980013SE	R0.05	0.1	3	0.2	40	3mm Shank
SEMD980015SE	R0.075	0.15	4	0.15	40	Short
SEMD980015E	R0.075	0.15	4	0.3	40	Regular
SEMD9800153SE	R0.075	0.15	3	0.3	40	3mm Shank
★ SEMD98002SE	R0.1	0.2	4	0.2	40	Short
★ SEMD98002E	R0.1	0.2	4	0.4	40	Regular
SEMD980023SE	R0.1	0.2	3	0.4	40	3mm Shank
★ SEMD98003SE	R0.15	0.3	4	0.3	40	Short
★ SEMD98003E	R0.15	0.3	4	0.6	40	Regular
SEMD980033SE	R0.15	0.3	3	0.6	40	3mm Shank
SEMD98004SE	R0.2	0.4	4	0.4	40	Short
★ SEMD98004E	R0.2	0.4	4	0.8	40	Regular
SEMD980043SE	R0.2	0.4	3	0.8	40	3mm Shank
★ SEMD98005SE	R0.25	0.5	4	0.5	40	Short
SEMD98005S6SE	R0.25	0.5	6	0.8	40	-
★ SEMD98005E	R0.25	0.5	4	1.0	40	Regular
SEMD980053SE	R0.25	0.5	3	1.0	40	3mm Shank
SEMD98006SE	R0.3	0.6	4	0.6	40	Short
★ SEMD98006E	R0.3	0.6	4	1.2	40	Regular
SEMD980063SE	R0.3	0.6	3	1.2	40	3mm Shank
SEMD98007SE	R0.35	0.7	4	0.7	40	Short
★ SEMD98007E	R0.35	0.7	4	1.4	40	Regular

★ : Stock Item

▶ NEXT PAGE

Size	Radius Tolerance (mm)	Mill Dia. Tolerance (mm)	Shank Dia. Tolerance
up to R3	± 0.005	0 ~ - 0.012	h5
over R3	± 0.010	0 ~ - 0.015	

◎ : Excellent ○ : Good

ISO Material Description	P										M			K							
	Non-alloy steel					Low alloy steel					High alloyed steel, and tool steel			Stainless steel			Grey cast iron		Nodular cast iron	Malleable cast iron	
VDI 3323	1	2	3	4	5	6	7	8	9	10	11	12	13	14	15	16	17	18	19	20	
HRc		13	25	28	32	10	29	32	38	15	35	15	23	10	10	26	3	25		21	
HB	125	190	250	270	300	180	275	300	350	200	325	200	240	180	180	260	160	250	130	230	
Recommend	○	○	○	◎	◎	○	◎	◎	◎	○	◎	○	○	○	○	○	○	○	○	○	
ISO Material Description	N										S						H				
	Aluminum-wrought alloy		Aluminum-cast, alloyed			Copper and Copper Alloys (Bronze / Brass)			Non Metallic Materials		Heat Resistant Super Alloys						Titanium Alloys		Hardened steel	Chilled Cast Iron	Hardened Cast Iron
VDI 3323	21	22	23	24	25	26	27	28	29	30	31	32	33	34	35	36	37	38	39	40	41
HRc											15	30	25	38	34			55	60	42	55
HB	60	100	75	90	130	110	90	100			200	280	250	350	320	400 Rm	1050 Rm	550	630	400	550
Recommend											○	○	○	○	○	○	○	○	○	◎	○

YG 4G MILL END MILLS

PLAIN SHANK **SEMD98** SERIES

CARBIDE, 2 FLUTE BALL NOSE (Short, Regular, Long Shank)

- VOLLHARTMETALL, 2 SCHNEIDEN STIRNRADIUS
- () Fraise carbure, 2 dents, hémisphérique
- () MD, 2 TAGLIENTI, SEMISFERICA (Serie corta, media e lunga)

- ▶ New coating and tool geometry applied resulting outstanding cutting abilities and wear resistance.
- ▶ With its unique ball nose geometry and cutting edges the cutting force has decreased, also increasing wear resistance.
- ▶ Excellent performance when cutting prehardened steels, up to HRC55 which are used for molds & dies.

- ▶ Aufgrund einer neuartigen Beschichtung und neuer Werkzeuggeometrien hervorragende Schnittleistung und Verschleißfestigkeit.
- ▶ Aufgrund der einzigartigen Kugelgeometrie und Schneidkantenpräparation wird die Schnittkraft reduziert und die Verschleißfestigkeit erhöht.
- ▶ Hervorragende Leistung bei der Zerspaltung von vorvergüteten Stählen bis HRC55, welche im Werkzeug- und Formenbau Verwendung finden.

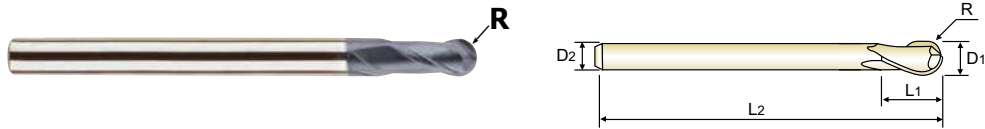

CARBIDE 2 30° ±0.005 ±0.010 PLAIN P.276-277

R0.05-R3 R3.25-R125

Unit : mm

EDP No.	Radius of Ball Nose	Mill Diameter	Shank Diameter	Length of Cut	Overall Length	Remark
	R	D1	D2	L1	L2	
SEMD980073SE	R0.35	0.7	3	1.4	40	3mm Shank
SEMD98008SE	R0.4	0.8	4	0.8	40	Short
★ SEMD98008E	R0.4	0.8	4	1.6	40	Regular
SEMD980083SE	R0.4	0.8	3	1.6	40	3mm Shank
SEMD98009SE	R0.45	0.9	4	0.9	40	Short
★ SEMD98009E	R0.45	0.9	4	1.8	40	Regular
SEMD980093SE	R0.45	0.9	3	1.8	40	3mm Shank
SEMD98010040E	R0.5	1.0	6	1.5	40	Short
SEMD980103SE	R0.5	1.0	3	2.5	50	3mm Shank
SEMD98010S4SE	R0.5	1.0	4	1.5	40	-
★ SEMD980104SE	R0.5	1.0	4	2.5	50	Regular
★ SEMD98010E	R0.5	1.0	6	2.5	50	Regular
★ SEMD98010070E	R0.5	1.0	6	2.5	70	Long Shank
SEMD98010100E	R0.5	1.0	6	2.5	100	Long Shank
SEMD98012040E	R0.6	1.2	6	2	40	Short
SEMD980123SE	R0.6	1.2	3	3	50	3mm Shank
SEMD980124SE	R0.6	1.2	4	3	50	Regular
★ SEMD98012E	R0.6	1.2	6	3	50	Regular
SEMD98012070E	R0.6	1.2	6	3	70	Long Shank
SEMD98012100E	R0.6	1.2	6	3	100	Long Shank
SEMD98015040E	R0.75	1.5	6	2.5	40	Short
SEMD980153SE	R0.75	1.5	3	4	50	3mm Shank
★ SEMD980154SE	R0.75	1.5	4	4	50	Regular
★ SEMD98015E	R0.75	1.5	6	4	50	Regular

★ : Stock Item

▶ NEXT PAGE

Size	Radius Tolerance (mm)	Mill Dia. Tolerance (mm)	Shank Dia. Tolerance
up to R3	± 0.005	0 ~ - 0.012	h5
over R3	± 0.010	0 ~ - 0.015	

◎ : Excellent ○ : Good

ISO Material Description	P											M			K							
	Non-alloy steel					Low alloy steel						High alloyed steel, and tool steel			Stainless steel			Grey cast iron		Nodular cast iron		Malleable cast iron
VDI 3323	1	2	3	4	5	6	7	8	9	10	11	12	13	14	15	16	17	18	19	20		
HRC	125	13	25	28	32	10	29	32	38	15	35	15	23	10	10	26	3	25	130	21		
HB	190	250	270	300	180	275	300	350	200	325	200	240	180	180	260	160	250	130	230			
Recommend	○	○	○	◎	◎	○	◎	◎	◎	◎	◎	◎	◎	○	○	○	○	○	○			

ISO Material Description	N					S					H										
	Aluminum-wrought alloy		Aluminum-cast, alloyed			Copper and Copper Alloys (Bronze / Brass)			Non Metallic Materials		Heat Resistant Super Alloys			Titanium Alloys		Hardened steel	Chilled Cast Iron	Hardened Cast Iron			
VDI 3323	21	22	23	24	25	26	27	28	29	30	31	32	33	34	35	36	37	38	39	40	41
HRC	60	100	75	90	130	110	90	100			15	30	25	38	34	400 Rm	1050 Rm	550	630	400	550
HB											200	280	250	350	320						
Recommend											○	○	○	○	○	○	○	○	◎	○	○

YG 4G MILL END MILLS

PLAIN SHANK

SEMD98 SERIES

CARBIDE, 2 FLUTE BALL NOSE (Short, Regular, Long Shank)

● **VOLLHARTMETALL, 2 SCHNEIDEN STIRNRADIUS**

● **Fraise carbure, 2 dents, hémisphérique**

● **MD, 2 TAGLIANTI, SEMISFERICA (Serie corta, media e lunga)**

- ▶ New coating and tool geometry applied resulting outstanding cutting abilities and wear resistance.
- ▶ With its unique ball nose geometry and cutting edges the cutting force has decreased, also increasing wear resistance.
- ▶ Excellent performance when cutting prehardened steels, up to HRc55 which are used for molds & dies.

- ▶ Aufgrund einer neuartigen Beschichtung und neuer Werkzeuggeometrien hervorragende Schnittleistung und Verschleißfestigkeit.
- ▶ Aufgrund der einzigartigen Kugelgeometrie und Schneidkantenpräparation wird die Schnittkraft reduziert und die Verschleißfestigkeit erhöht.
- ▶ Hervorragende Leistung bei der Zerspaltung von vorvergüteten Stählen bis HRc55, welche im Werkzeug- und Formenbau Verwendung finden.

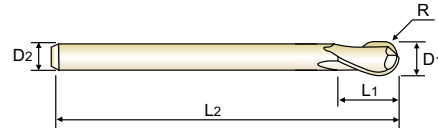

CARBIDE
2
30°
R ±0.005
R ±0.010
PLAIN
P.276-277

R0.05-R3 R325-R125

Unit : mm

EDP No.	Radius of Ball Nose	Mill Diameter	Shank Diameter	Length of Cut	Overall Length	Remark
	R	D1	D2	L1	L2	
★ SEMD98015070E	R0.75	1.5	6	4	70	Long Shank
SEMD98015100E	R0.75	1.5	6	4	100	Long Shank
★ SEMD98020040E	R1.0	2.0	6	3	40	Short
SEMD9802035E	R1.0	2.0	3	5	50	3mm Shank
★ SEMD9802045E	R1.0	2.0	4	5	50	Regular
★ SEMD98020E	R1.0	2.0	6	5	50	Regular
★ SEMD98020080E	R1.0	2.0	6	5	80	Long Shank
SEMD98020100E	R1.0	2.0	6	5	100	Long Shank
SEMD98025040E	R1.25	2.5	6	4	40	Short
SEMD9802535E	R1.25	2.5	3	6	60	3mm Shank
★ SEMD9802545E	R1.25	2.5	4	6	60	Regular
★ SEMD98025E	R1.25	2.5	6	6	60	Regular
★ SEMD98025080E	R1.25	2.5	6	6	80	Long Shank
SEMD98025100E	R1.25	2.5	6	6	100	Long Shank
★ SEMD98030040E	R1.5	3.0	6	4.5	40	Short
SEMD9803035E	R1.5	3.0	3	6	60	3mm Shank
★ SEMD9803045E	R1.5	3.0	4	6	60	Regular
★ SEMD98030E	R1.5	3.0	6	6	60	Regular
★ SEMD98030080E	R1.5	3.0	6	6	80	Long Shank
★ SEMD98030100E	R1.5	3.0	6	6	100	Long Shank
★ SEMD98035E	R1.75	3.5	6	8	70	-
★ SEMD98040050E	R2.0	4.0	6	6	50	Short
★ SEMD9804045E	R2.0	4.0	4	8	70	Regular
★ SEMD98040E	R2.0	4.0	6	8	70	Regular

★ : Stock Item

▶ NEXT PAGE

Size	Radius Tolerance (mm)	Mill Dia. Tolerance (mm)	Shank Dia. Tolerance
up to R3	± 0.005	0 ~ - 0.012	h5
over R3	± 0.010	0 ~ - 0.015	

◎ : Excellent ○ : Good

ISO Material Description	P										M			K							
	Non-alloy steel					Low alloy steel					High alloyed steel, and tool steel			Stainless steel			Grey cast iron		Nodular cast iron		Malleable cast iron
VDI 3323	1	2	3	4	5	6	7	8	9	10	11	12	13	14	15	16	17	18	19	20	
HRc		13	25	28	32	10	29	32	38	15	35	15	23	10	10	26	3	25		21	
HB	125	190	250	270	300	180	275	300	350	200	325	200	240	180	180	260	160	250	130	230	
Recommend	○	○	○	◎	◎	○	◎	◎	◎	○	◎	○	○	○	○	○	○	○	○	○	
ISO Material Description	N										S						H				
	Aluminum-wrought alloy		Aluminum-cast, alloyed			Copper and Copper Alloys (Bronze / Brass)			Non Metallic Materials		Heat Resistant Super Alloys						Titanium Alloys		Hardened steel	Chilled Cast Iron	Hardened Cast Iron
VDI 3323	21	22	23	24	25	26	27	28	29	30	31	32	33	34	35	36	37	38	39	40	41
HRc											15	30	25	38	34			55	60	42	55
HB	60	100	75	90	130	110	90	100			200	280	250	350	320	400 Rm	1050 Rm	550	630	400	550
Recommend	○	○	○	○	○	○	○	○	○	○	○	○	○	○	○	○	○	○	○	○	○

YG 4G MILL END MILLS

PLAIN SHANK **SEMD98** SERIES

CARBIDE, 2 FLUTE BALL NOSE (Short, Regular, Long Shank)

- VOLLHARTMETALL, 2 SCHNEIDEN STIRNRADIUS
- () Fraise carbure, 2 dents, hémisphérique
- () MD, 2 TAGLIENTI, SEMISFERICA (Serie corta, media e lunga)

- ▶ New coating and tool geometry applied resulting outstanding cutting abilities and wear resistance.
- ▶ With its unique ball nose geometry and cutting edges the cutting force has decreased, also increasing wear resistance.
- ▶ Excellent performance when cutting prehardened steels, up to HRC55 which are used for molds & dies.
- ▶ Aufgrund einer neuartigen Beschichtung und neuer Werkzeuggeometrien hervorragende Schnittleistung und Verschleißfestigkeit.
- ▶ Aufgrund der einzigartigen Kugelgeometrie und Schneidkantenpräparation wird die Schnittkraft reduziert und die Verschleißfestigkeit erhöht.
- ▶ Hervorragende Leistung bei der Zerspaltung von vorvergüteten Stählen bis HRC55, welche im Werkzeug- und Formenbau Verwendung finden.

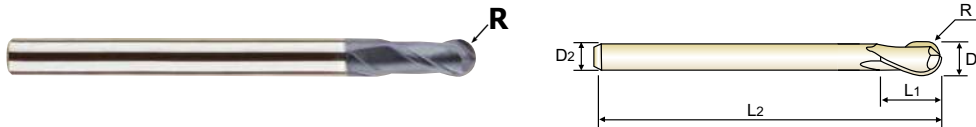

CARBIDE 2 30° ±0.005 ±0.010 PLAIN P.276-277

R0.05-R3 R3.25-R125

Unit : mm

EDP No.	Radius of Ball Nose	Mill Diameter	Shank Diameter	Length of Cut	Overall Length	Remark
	R	D1	D2	L1	L2	
★ SEMD980401004SE	R2.0	4.0	4	8	100	Long Shank
SEMD980401204SE	R2.0	4.0	4	8	120	Long Shank
★ SEMD98040100E	R2.0	4.0	6	8	100	Long Shank
★ SEMD98040120E	R2.0	4.0	6	8	120	Long Shank
★ SEMD98045E	R2.25	4.5	6	9	80	-
★ SEMD98050060E	R2.5	5.0	6	7.5	60	Short
★ SEMD98050E	R2.5	5.0	6	10	80	Regular
SEMD980505SE	R2.5	5.0	5	10	80	5mmShank
★ SEMD98055E	R2.75	5.5	6	11	90	-
★ SEMD98060050E	R3.0	6.0	6	9	50	Short
★ SEMD98060060E	R3.0	6.0	6	9	60	Short
★ SEMD98060080E	R3.0	6.0	6	9	80	Short
★ SEMD98060E	R3.0	6.0	6	12	90	Regular
★ SEMD98060110E	R3.0	6.0	6	12	110	Long Shank
★ SEMD98060130E	R3.0	6.0	6	12	130	Long Shank
★ SEMD98060150E	R3.0	6.0	6	12	150	Long Shank
★ SEMD98065E	R3.25	6.5	8	13	90	-
★ SEMD98070E	R3.5	7.0	8	14	90	-
★ SEMD98080050E	R4.0	8.0	8	12	50	Short
★ SEMD98080060E	R4.0	8.0	8	12	60	Short
★ SEMD98080080E	R4.0	8.0	8	12	80	Short
★ SEMD98080090E	R4.0	8.0	8	12	90	Short
★ SEMD98080E	R4.0	8.0	8	14	100	Regular
★ SEMD98080130E	R4.0	8.0	8	14	130	Long Shank

★ : Stock Item

▶ NEXT PAGE

Size	Radius Tolerance (mm)	Mill Dia. Tolerance (mm)	Shank Dia. Tolerance
up to R3	± 0.005	0 ~ - 0.012	h5
over R3	± 0.010	0 ~ - 0.015	

◎ : Excellent ○ : Good

ISO Material Description	P											M			K							
	Non-alloy steel					Low alloy steel						High alloyed steel, and tool steel			Stainless steel			Grey cast iron		Nodular cast iron		Malleable cast iron
VDI 3323	1	2	3	4	5	6	7	8	9	10	11	12	13	14	15	16	17	18	19	20		
HRC		13	25	28	32	10	29	32	38	15	35	15	23	10	10	26	3	25		21		
HB	125	190	250	270	300	180	275	300	350	200	325	200	240	180	180	260	160	250	130	230		
Recommend	○	○	○	◎	◎	○	◎	◎	◎	◎	◎	○	○	○	○	○	○	○	○	○		
ISO Material Description	N									S						H						
	Aluminum-wrought alloy		Aluminum-cast, alloyed			Copper and Copper Alloys (Bronze / Brass)				Non Metallic Materials		Heat Resistant Super Alloys						Titanium Alloys		Hardened steel	Chilled Cast Iron	Hardened Cast Iron
VDI 3323	21	22	23	24	25	26	27	28	29	30	31	32	33	34	35	36	37	38	39	40	41	
HRC											15	30	25	38	34			55	60	42	55	
HB	60	100	75	90	130	110	90	100			200	280	250	350	320	400 Rm	1050 Rm	550	630	400	550	
Recommend											○	○	○	○	○	○	○	○	○	◎	○	

YG 4G MILL END MILLS

PLAIN SHANK

SEMD98 SERIES

CARBIDE, 2 FLUTE BALL NOSE (Short, Regular, Long Shank)

- **VOLLHARTMETALL, 2 SCHNEIDEN STIRNRADIUS**
- **Fraise carbure, 2 dents, hémisphérique**
- **MD, 2 TAGLIANTI, SEMISFERICA (Serie corta, media e lunga)**

- ▶ New coating and tool geometry applied resulting outstanding cutting abilities and wear resistance.
- ▶ With its unique ball nose geometry and cutting edges the cutting force has decreased, also increasing wear resistance.
- ▶ Excellent performance when cutting prehardened steels, up to HRc55 which are used for molds & dies.

- ▶ Aufgrund einer neuartigen Beschichtung und neuer Werkzeuggeometrien hervorragende Schnittleistung und Verschleißfestigkeit.
- ▶ Aufgrund der einzigartigen Kugelgeometrie und Schneidkantenpräparation wird die Schnittkraft reduziert und die Verschleißfestigkeit erhöht.
- ▶ Hervorragende Leistung bei der Zerspaltung von vorvergüteten Stählen bis HRc55, welche im Werkzeug- und Formenbau Verwendung finden.

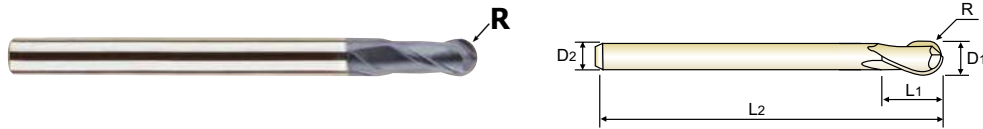

CARBIDE
2
30°
R ±0.005
R ±0.010
PLAIN
P.276-277

R0.05-R3 R325-R125

Unit : mm

EDP No.	Radius of Ball Nose	Mill Diameter	Shank Diameter	Length of Cut	Overall Length	Remark
	R	D1	D2	L1	L2	
★ SEMD98080150E	R4.0	8.0	8	14	150	Long Shank
★ SEMD98085E	R4.25	8.5	10	16	100	-
★ SEMD98090E	R4.5	9.0	10	18	100	-
SEMD98100050E	R5.0	10.0	10	15	50	Short
★ SEMD98100060E	R5.0	10.0	10	15	60	Short
★ SEMD98100080E	R5.0	10.0	10	15	80	Short
★ SEMD98100090E	R5.0	10.0	10	15	90	Short
★ SEMD98100E	R5.0	10.0	10	18	100	Regular
★ SEMD98100130E	R5.0	10.0	10	18	130	Long Shank
★ SEMD98100150E	R5.0	10.0	10	18	150	Long Shank
★ SEMD98100180E	R5.0	10.0	10	18	180	Long Shank
SEMD98100200E	R5.0	10.0	10	18	200	Long Shank
★ SEMD98110E	R5.5	11.0	12	20	100	-
SEMD98120060E	R6.0	12.0	12	18	60	Short
★ SEMD98120080E	R6.0	12.0	12	18	80	Short
SEMD98120090E	R6.0	12.0	12	18	90	Short
★ SEMD98120100E	R6.0	12.0	12	18	100	Short
★ SEMD98120E	R6.0	12.0	12	22	110	Regular
★ SEMD98120130E	R6.0	12.0	12	22	130	Long Shank
★ SEMD98120150E	R6.0	12.0	12	22	150	Long Shank
★ SEMD98120180E	R6.0	12.0	12	22	180	Long Shank
★ SEMD98120200E	R6.0	12.0	12	22	200	Long Shank
★ SEMD98130E	R6.5	13.0	12	24	100	-
★ SEMD98140E	R7.0	14.0	12	26	100	Regular

★ : Stock Item

▶ NEXT PAGE

Size	Radius Tolerance (mm)	Mill Dia. Tolerance (mm)	Shank Dia. Tolerance
up to R3	± 0.005	0 ~ - 0.012	h5
over R3	± 0.010	0 ~ - 0.015	

◎ : Excellent ○ : Good

ISO Material Description	P											M			K						
	Non-alloy steel					Low alloy steel				High alloyed steel, and tool steel		Stainless steel			Grey cast iron		Nodular cast iron		Malleable cast iron		
VDI 3323	1	2	3	4	5	6	7	8	9	10	11	12	13	14	15	16	17	18	19	20	
HRc		13	25	28	32	10	29	32	38	15	35	15	23	10	10	26	3	25		21	
HB	125	190	250	270	300	180	275	300	350	200	325	200	240	180	180	260	160	250	130	230	
Recommend	○	○	○	◎	◎	◎	◎	◎	◎	○	◎	○	○	○	○	○	○	○	○	○	
ISO Material Description	N										S						H				
	Aluminum-wrought alloy		Aluminum-cast, alloyed			Copper and Copper Alloys (Bronze / Brass)			Non Metallic Materials		Heat Resistant Super Alloys						Titanium Alloys		Hardened steel	Chilled Cast Iron	Hardened Cast Iron
VDI 3323	21	22	23	24	25	26	27	28	29	30	31	32	33	34	35	36	37	38	39	40	41
HRc											15	30	25	38	34			55	60	42	55
HB	60	100	75	90	130	110	90	100			200	280	250	350	320	400 Rm	1050 Rm	550	630	400	550
Recommend											○	○	○	○	○	○	○	○	○	◎	○

CARBIDE, 2 FLUTE BALL NOSE (Short, Regular, Long Shank)

- VOLLHARTMETALL, 2 SCHNEIDEN STIRNRADIUS
- () Fraise carbure, 2 dents, hémisphérique
- () MD, 2 TAGLIENTI, SEMISFERICA (Serie corta, media e lunga)

- ▶ New coating and tool geometry applied resulting outstanding cutting abilities and wear resistance.
 - ▶ With its unique ball nose geometry and cutting edges the cutting force has decreased, also increasing wear resistance.
 - ▶ Excellent performance when cutting prehardened steels, up to HRC55 which are used for molds & dies.
- ▶ Aufgrund einer neuartigen Beschichtung und neuer Werkzeuggeometrien hervorragende Schnittleistung und Verschleißfestigkeit.
 - ▶ Aufgrund der einzigartigen Kugelgeometrie und Schneidkantenpräparation wird die Schnittkraft reduziert und die Verschleißfestigkeit erhöht.
 - ▶ Hervorragende Leistung bei der Zerspaltung von vorvergüteten Stählen bis HRC55, welche im Werkzeug- und Formenbau Verwendung finden.

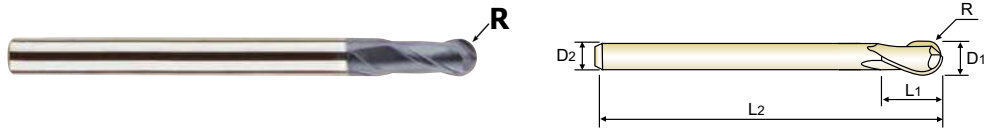

R0.05-R3 R3.25-R125

Unit : mm

EDP No.	Radius of Ball Nose	Mill Diameter	Shank Diameter	Length of Cut	Overall Length	Remark
	R	D1	D2	L1	L2	
★ SEMD9814014SE	R7.0	14.0	14	26	100	-
SEMD9814016SE	R7.0	14.0	16	26	100	-
SEMD98150E	R7.5	15.0	16	28	140	-
★ SEMD98160100E	R8.0	16.0	16	24	100	Short
SEMD98160130E	R8.0	16.0	16	24	130	Short
★ SEMD98160E	R8.0	16.0	16	30	150	Regular
SEMD98160180E	R8.0	16.0	16	30	180	Long Shank
★ SEMD98160200E	R8.0	16.0	16	30	200	Long Shank
★ SEMD98180E	R9.0	18.0	16	34	150	Regular
SEMD9818018SE	R9.0	18.0	18	34	150	-
★ SEMD98200100E	R10.0	20.0	20	30	100	Short
SEMD98200130E	R10.0	20.0	20	30	130	Short
★ SEMD98200E	R10.0	20.0	20	38	150	Regular
SEMD98200200E	R10.0	20.0	20	38	200	Long Shank
SEMD98250120E	R12.5	25.0	25	50	120	Short
SEMD98250E	R12.5	25.0	25	50	180	Regular

★ : Stock Item

Size	Radius Tolerance (mm)	Mill Dia. Tolerance (mm)	Shank Dia. Tolerance
up to R3	± 0.005	0 ~ - 0.012	h5
over R3	± 0.010	0 ~ - 0.015	

◎ : Excellent ○ : Good

ISO Material Description	P										M				K						
	Non-alloy steel					Low alloy steel					High alloyed steel, and tool steel				Stainless steel		Grey cast iron		Nodular cast iron		Malleable cast iron
VDI 3323	1	2	3	4	5	6	7	8	9	10	11	12	13	14	15	16	17	18	19	20	
HRC	13	25	28	32	10	29	32	38	15	35	15	23	10	10	26	3	25	130	21		
HB	125	190	250	270	300	180	275	300	350	200	325	200	240	180	180	260	160	250	130	230	
Recommend	○	○	○	◎	◎	○	◎	◎	◎	○	◎	○	○	○	○	○	○	○	○	○	

ISO Material Description	N					S										H					
	Aluminum-wrought alloy		Aluminum-cast, alloyed			Copper and Copper Alloys (Bronze / Brass)			Non Metallic Materials		Heat Resistant Super Alloys					Titanium Alloys		Hardened steel	Chilled Cast Iron	Hardened Cast Iron	
VDI 3323	21	22	23	24	25	26	27	28	29	30	31	32	33	34	35	36	37	38	39	40	41
HRC	60	100	75	90	130	110	90	100			15	30	25	38	34	400 Rm	1050 Rm	55	60	42	55
HB	60	100	75	90	130	110	90	100			200	280	250	350	320	400 Rm	1050 Rm	550	630	400	550
Recommend																		○	◎	◎	○

CARBIDE, 2 FLUTE BALL NOSE with EXTENDED NECK

- **VOLLHARTMETALL, 2 SCHNEIDEN STIRNRADIUS mit LANG ABGESETZTEM SCHAFTTETL**
- **Fraise carbure, 2 dents, hémisphérique, détalonnée**
- **MD, 2 TAGLIANTI, SEMISFERICA, SCARICATA**

- ▶ New coating and tool geometry applied resulting outstanding cutting abilities and wear resistance.
- ▶ With its unique ball nose geometry and cutting edges the cutting force has decreased, also increasing wear resistance.
- ▶ Excellent performance when cutting prehardened steels, up to HRc55 which are used for molds & dies.

- ▶ Aufgrund einer neuartigen Beschichtung und neuer Werkzeuggeometrien hervorragende Schnittleistung und Verschleißfestigkeit.
- ▶ Aufgrund der einzigartigen Kugelgeometrie und Schneidkantenpräparation wird die Schnittkraft reduziert und die Verschleißfestigkeit erhöht.
- ▶ Hervorragende Leistung bei der Zerspaltung von vorvergüteten Stählen bis HRc55, welche im Werkzeug- und Formenbau Verwendung finden.

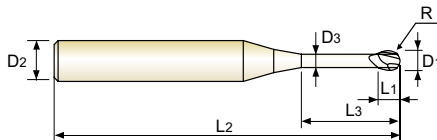

CARBIDE 2 30° ±0.005 ±0.010 PLAIN P.278-289

R0.05-R3 R4-R6

Unit : mm

EDP No.	Radius of Ball Nose	Mill Diameter	Shank Diameter	Length of Cut	Length Below Shank	Overall Length	Neck Diameter
	R	D1	D2	L1	L3	L2	D3
SEM846001002E	R0.05	0.1	4	0.1	0.2	40	0.085
SEM846001003E	R0.05	0.1	4	0.1	0.3	40	0.085
SEM846001005E	R0.05	0.1	4	0.1	0.5	40	0.085
SEM84600101E	R0.05	0.1	4	0.1	1	40	0.085
★ SEM846002005E	R0.1	0.2	4	0.2	0.5	40	0.17
★ SEM84600201E	R0.1	0.2	4	0.2	1	40	0.17
SEM846002015E	R0.1	0.2	4	0.2	1.5	40	0.17
★ SEM84600202E	R0.1	0.2	4	0.2	2	40	0.17
SEM84600203E	R0.1	0.2	4	0.2	3	40	0.17
★ SEM84600301E	R0.15	0.3	4	0.3	1	40	0.27
★ SEM846003015E	R0.15	0.3	4	0.3	1.5	40	0.27
★ SEM84600302E	R0.15	0.3	4	0.3	2	40	0.27
SEM846003025E	R0.15	0.3	4	0.3	2.5	40	0.27
★ SEM84600303E	R0.15	0.3	4	0.3	3	40	0.27
★ SEM84600304E	R0.15	0.3	4	0.3	4	40	0.27
SEM84600305E	R0.15	0.3	4	0.3	5	40	0.27
★ SEM84600401E	R0.2	0.4	4	0.4	1	40	0.37
★ SEM846004015E	R0.2	0.4	4	0.4	1.5	40	0.37
★ SEM84600402E	R0.2	0.4	4	0.4	2	40	0.37
★ SEM846004025E	R0.2	0.4	4	0.4	2.5	40	0.37
★ SEM84600403E	R0.2	0.4	4	0.4	3	40	0.37
★ SEM84600404E	R0.2	0.4	4	0.4	4	40	0.37
★ SEM84600405E	R0.2	0.4	4	0.4	5	40	0.37
★ SEM84600406E	R0.2	0.4	4	0.4	6	40	0.37

★ : Stock Item

▶ NEXT PAGE

Size	Radius Tolerance (mm)	Mill Dia. Tolerance (mm)	Shank Dia. Tolerance
up to R3	± 0.005	0 ~ - 0.012	h5
over R3	± 0.010	0 ~ - 0.015	

◎ : Excellent ○ : Good

ISO Material Description	P										M			K							
	Non-alloy steel					Low alloy steel					High alloyed steel, and tool steel		Stainless steel			Grey cast iron		Nodular cast iron		Malleable cast iron	
VDI 3323	1	2	3	4	5	6	7	8	9	10	11	12	13	14	15	16	17	18	19	20	
HRc		13	25	28	32	10	29	32	38	15	35	15	23	10	10	26	3	25		21	
HB	125	190	250	270	300	180	275	300	350	200	325	200	240	180	180	260	160	250	130	230	
Recommend	○	○	○	○	◎	◎	◎	◎	◎	○	◎	○	○	○	○	○	○	○	○	○	
ISO Material Description	N										S						H				
	Aluminum-wrought alloy		Aluminum-cast, alloyed			Copper and Copper Alloys (Bronze / Brass)			Non Metallic Materials		Heat Resistant Super Alloys				Titanium Alloys		Hardened steel	Chilled Cast Iron	Hardened Cast Iron		
VDI 3323	21	22	23	24	25	26	27	28	29	30	31	32	33	34	35	36	37	38	39	40	41
HRc											15	30	25	38	34			55	60	42	55
HB	60	100	75	90	130	110	90	100			200	280	250	350	320	400 Rm	1050 Rm	550	630	400	550
Recommend											○	○	○	○	○	○	○	○	○	◎	○

CARBIDE, 2 FLUTE BALL NOSE with EXTENDED NECK

- VOLLHARTMETALL, 2 SCHNEIDEN STIRNRADIUS mit LANG ABGESETZTEM SCHAFTTETL
- () Fraise carbure, 2 dents, hémisphérique, détalonnée
- () MD, 2 TAGLIENTI, SEMISFERICA, SCARICATA

- ▶ New coating and tool geometry applied resulting outstanding cutting abilities and wear resistance.
- ▶ With its unique ball nose geometry and cutting edges the cutting force has decreased, also increasing wear resistance.
- ▶ Excellent performance when cutting prehardened steels, up to HRC55 which are used for molds & dies.

- ▶ Aufgrund einer neuartigen Beschichtung und neuer Werkzeuggeometrien hervorragende Schnittleistung und Verschleißfestigkeit.
- ▶ Aufgrund der einzigartigen Kugelgeometrie und Schneidkantenpräparation wird die Schnittkraft reduziert und die Verschleißfestigkeit erhöht.
- ▶ Hervorragende Leistung bei der Zerspaltung von vorvergüteten Stählen bis HRC55, welche im Werkzeug- und Formenbau Verwendung finden.

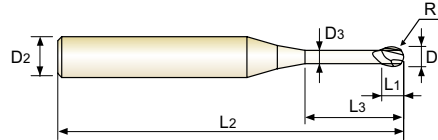

CARBIDE 2 30° ±0.005 ±0.010 PLAIN P.278-289

R0.05-R3 R4-R6

Unit : mm

EDP No.	Radius of Ball Nose	Mill Diameter	Shank Diameter	Length of Cut	Length Below Shank	Overall Length	Neck Diameter
	R	D1	D2	L1	L3	L2	D3
SEM84600408E	R0.2	0.4	4	0.4	8	40	0.37
SEM84600410E	R0.2	0.4	4	0.4	10	40	0.37
★ SEM84600501E	R0.25	0.5	4	0.5	1	45	0.45
SEM846005015E	R0.25	0.5	4	0.5	1.5	45	0.45
★ SEM84600502E	R0.25	0.5	4	0.5	2	45	0.45
SEM846005025E	R0.25	0.5	4	0.5	2.5	45	0.45
★ SEM84600503E	R0.25	0.5	4	0.5	3	45	0.45
★ SEM84600504E	R0.25	0.5	4	0.5	4	45	0.45
★ SEM84600505E	R0.25	0.5	4	0.5	5	45	0.45
★ SEM84600506E	R0.25	0.5	4	0.5	6	45	0.45
★ SEM84600508E	R0.25	0.5	4	0.5	8	45	0.45
★ SEM84600510E	R0.25	0.5	4	0.5	10	45	0.45
SEM84600512E	R0.25	0.5	4	0.5	12	45	0.45
SEM84600514E	R0.25	0.5	4	0.5	14	45	0.45
SEM84600516E	R0.25	0.5	4	0.5	16	45	0.45
★ SEM84600601E	R0.3	0.6	4	0.6	1	45	0.55
★ SEM84600602E	R0.3	0.6	4	0.6	2	45	0.55
★ SEM84600603E	R0.3	0.6	4	0.6	3	45	0.55
★ SEM84600604E	R0.3	0.6	4	0.6	4	45	0.55
★ SEM84600605E	R0.3	0.6	4	0.6	5	45	0.55
★ SEM84600606E	R0.3	0.6	4	0.6	6	45	0.55
★ SEM84600608E	R0.3	0.6	4	0.6	8	45	0.55
★ SEM84600610E	R0.3	0.6	4	0.6	10	45	0.55
★ SEM84600612E	R0.3	0.6	4	0.6	12	45	0.55

★ : Stock Item

▶ NEXT PAGE

Size	Radius Tolerance (mm)	Mill Dia. Tolerance (mm)	Shank Dia. Tolerance
up to R3	± 0.005	0 ~ - 0.012	h5
over R3	± 0.010	0 ~ - 0.015	

◎ : Excellent ○ : Good

ISO Material Description	P										M			K						
	Non-alloy steel					Low alloy steel					High alloyed steel, and tool steel			Stainless steel			Grey cast iron		Nodular cast iron	
VDI 3323	1	2	3	4	5	6	7	8	9	10	11	12	13	14	15	16	17	18	19	20
HRC	125	13	25	28	32	10	29	32	38	15	35	15	23	10	10	26	3	25	42	21
HB	190	190	250	270	300	180	275	300	350	200	325	200	240	180	180	260	160	250	130	230
Recommend	○	○	○	◎	◎	○	◎	◎	◎	◎	◎	◎	◎	◎	○	○	○	○	○	○

ISO Material Description	N					S					H										
	Aluminum-wrought alloy		Aluminum-cast, alloyed		Copper and Copper Alloys (Bronze / Brass)		Non Metallic Materials		Heat Resistant Super Alloys			Titanium Alloys		Hardened steel	Chilled Cast Iron	Hardened Cast Iron					
VDI 3323	21	22	23	24	25	26	27	28	29	30	31	32	33	34	35	36	37	38	39	40	41
HRC	60	100	75	90	130	110	90	100			15	30	25	38	34	36	37	55	60	42	55
HB	60	100	75	90	130	110	90	100			200	280	250	350	320	400 Rm	1050 Rm	550	630	400	550
Recommend																		○	◎	◎	○

CARBIDE, 2 FLUTE BALL NOSE with EXTENDED NECK

- **VOLLHARTMETALL, 2 SCHNEIDEN STIRNRADIUS mit LANG ABGESETZTEM SCHAFTTETL**
- **Fraise carbure, 2 dents, hémisphérique, détalonnée**
- **MD, 2 TAGLIANTI, SEMISFERICA, SCARICATA**

- ▶ New coating and tool geometry applied resulting outstanding cutting abilities and wear resistance.
- ▶ With its unique ball nose geometry and cutting edges the cutting force has decreased, also increasing wear resistance.
- ▶ Excellent performance when cutting prehardened steels, up to HRc55 which are used for molds & dies.

- ▶ Aufgrund einer neuartigen Beschichtung und neuer Werkzeuggeometrien hervorragende Schnittleistung und Verschleißfestigkeit.
- ▶ Aufgrund der einzigartigen Kugelgeometrie und Schneidkantenpräparation wird die Schnittkraft reduziert und die Verschleißfestigkeit erhöht.
- ▶ Hervorragende Leistung bei der Zerspaltung von vorvergüteten Stählen bis HRc55, welche im Werkzeug- und Formenbau Verwendung finden.

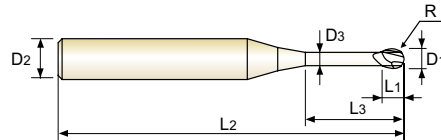

CARBIDE
2
30°
R ±0.005
R ±0.010
PLAIN
P.278-289

R0.05-R3 R4-R6

Unit : mm

EDP No.	Radius of Ball Nose	Mill Diameter	Shank Diameter	Length of Cut	Length Below Shank	Overall Length	Neck Diameter
	R	D1	D2	L1	L3	L2	D3
SEM84600614E	R0.3	0.6	4	0.6	14	45	0.55
SEM84600616E	R0.3	0.6	4	0.6	16	45	0.55
★ SEM84600702E	R0.35	0.7	4	0.7	2	45	0.65
★ SEM84600704E	R0.35	0.7	4	0.7	4	45	0.65
★ SEM84600706E	R0.35	0.7	4	0.7	6	45	0.65
SEM84600708E	R0.35	0.7	4	0.7	8	45	0.65
SEM84600710E	R0.35	0.7	4	0.7	10	45	0.65
SEM84600712E	R0.35	0.7	4	0.7	12	45	0.65
SEM84600801E	R0.4	0.8	4	0.8	1	45	0.75
★ SEM84600802E	R0.4	0.8	4	0.8	2	45	0.75
★ SEM84600803E	R0.4	0.8	4	0.8	3	45	0.75
★ SEM84600804E	R0.4	0.8	4	0.8	4	45	0.75
★ SEM84600805E	R0.4	0.8	4	0.8	5	45	0.75
★ SEM84600806E	R0.4	0.8	4	0.8	6	45	0.75
★ SEM84600808E	R0.4	0.8	4	0.8	8	45	0.75
★ SEM84600810E	R0.4	0.8	4	0.8	10	45	0.75
★ SEM84600812E	R0.4	0.8	4	0.8	12	45	0.75
SEM84600814E	R0.4	0.8	4	0.8	14	45	0.75
SEM84600816E	R0.4	0.8	4	0.8	16	45	0.75
SEM84600820E	R0.4	0.8	4	0.8	20	45	0.75
★ SEM84600904E	R0.45	0.9	4	0.9	4	45	0.85
SEM84600906E	R0.45	0.9	4	0.9	6	45	0.85
★ SEM84600908E	R0.45	0.9	4	0.9	8	45	0.85
SEM84600910E	R0.45	0.9	4	0.9	10	45	0.85

★ : Stock Item

▶ NEXT PAGE

Size	Radius Tolerance (mm)	Mill Dia. Tolerance (mm)	Shank Dia. Tolerance
up to R3	± 0.005	0 ~ - 0.012	h5
over R3	± 0.010	0 ~ - 0.015	

◎ : Excellent ○ : Good

ISO Material Description	P											M			K						
	Non-alloy steel					Low alloy steel				High alloyed steel, and tool steel		Stainless steel			Grey cast iron		Nodular cast iron		Malleable cast iron		
VDI 3323	1	2	3	4	5	6	7	8	9	10	11	12	13	14	15	16	17	18	19	20	
HRc		13	25	28	32	10	29	32	38	15	35	15	23	10	10	26	3	25		21	
HB	125	190	250	270	300	180	275	300	350	200	325	200	240	180	180	260	160	250	130	230	
Recommend	○	○	○	◎	◎	○	◎	◎	◎	○	◎	○	○	○	○	○	○	○	○	○	
ISO Material Description	N										S						H				
	Aluminum-wrought alloy		Aluminum-cast, alloyed			Copper and Copper Alloys (Bronze / Brass)			Non Metallic Materials		Heat Resistant Super Alloys				Titanium Alloys		Hardened steel	Chilled Cast Iron	Hardened Cast Iron		
VDI 3323	21	22	23	24	25	26	27	28	29	30	31	32	33	34	35	36	37	38	39	40	41
HRc											15	30	25	38	34			55	60	42	55
HB	60	100	75	90	130	110	90	100			200	280	250	350	320	400 Rm	1050 Rm	550	630	400	550
Recommend											○	○	○	○	○	○	○	○	◎	◎	○

CARBIDE, 2 FLUTE BALL NOSE with EXTENDED NECK

- VOLLHARTMETALL, 2 SCHNEIDEN STIRNRADIUS mit LANG ABGESETZTEM SCHAFTTETTEL
- () Fraise carbure, 2 dents, hémisphérique, détalonnée
- () MD, 2 TAGLIENTI, SEMISFERICA, SCARICATA

- ▶ New coating and tool geometry applied resulting outstanding cutting abilities and wear resistance.
- ▶ With its unique ball nose geometry and cutting edges the cutting force has decreased, also increasing wear resistance.
- ▶ Excellent performance when cutting prehardened steels, up to HRC55 which are used for molds & dies.

- ▶ Aufgrund einer neuartigen Beschichtung und neuer Werkzeuggeometrien hervorragende Schnittleistung und Verschleißfestigkeit.
- ▶ Aufgrund der einzigartigen Kugelgeometrie und Schneidkantenpräparation wird die Schnittkraft reduziert und die Verschleißfestigkeit erhöht.
- ▶ Hervorragende Leistung bei der Zerspaltung von vorvergüteten Stählen bis HRC55, welche im Werkzeug- und Formenbau Verwendung finden.

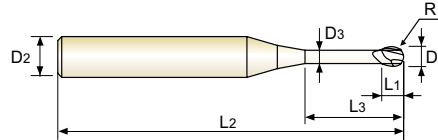

CARBIDE 2 30° ±0.005 ±0.010 PLAIN P.278-289

R0.05-R3 R4-R6

Unit : mm

EDP No.	Radius of Ball Nose	Mill Diameter	Shank Diameter	Length of Cut	Length Below Shank	Overall Length	Neck Diameter
	R	D1	D2	L1	L3	L2	D3
★ SEM84601002E	R0.5	1.0	4	1	2	50	0.95
★ SEM84601003E	R0.5	1.0	4	1	3	50	0.95
★ SEM84601004E	R0.5	1.0	4	1	4	50	0.95
★ SEM84601005E	R0.5	1.0	4	1	5	50	0.95
★ SEM84601006E	R0.5	1.0	4	1	6	50	0.95
★ SEM84601007E	R0.5	1.0	4	1	7	50	0.95
★ SEM84601008E	R0.5	1.0	4	1	8	50	0.95
SEM84601009E	R0.5	1.0	4	1	9	50	0.95
★ SEM84601010E	R0.5	1.0	4	1	10	50	0.95
★ SEM84601012E	R0.5	1.0	4	1	12	50	0.95
★ SEM84601014E	R0.5	1.0	4	1	14	50	0.95
★ SEM84601016E	R0.5	1.0	4	1	16	50	0.95
★ SEM84601018E	R0.5	1.0	4	1	18	50	0.95
★ SEM84601020E	R0.5	1.0	4	1	20	50	0.95
SEM84601022E	R0.5	1.0	4	1	22	60	0.95
★ SEM84601026E	R0.5	1.0	4	1	26	60	0.95
★ SEM84601030E	R0.5	1.0	4	1	30	70	0.95
SEM84601040E	R0.5	1.0	4	1	40	80	0.95
SEM84601050E	R0.5	1.0	4	1	50	100	0.95
★ SEM84601204E	R0.6	1.2	4	1.2	4	50	1.15
★ SEM84601206E	R0.6	1.2	4	1.2	6	50	1.15
★ SEM84601208E	R0.6	1.2	4	1.2	8	50	1.15
★ SEM84601210E	R0.6	1.2	4	1.2	10	50	1.15
★ SEM84601212E	R0.6	1.2	4	1.2	12	50	1.15

★ : Stock Item

▶ NEXT PAGE

Size	Radius Tolerance (mm)	Mill Dia. Tolerance (mm)	Shank Dia. Tolerance
up to R3	± 0.005	0 ~ - 0.012	h5
over R3	± 0.010	0 ~ - 0.015	

◎ : Excellent ○ : Good

ISO Material Description	P										M			K							
	Non-alloy steel					Low alloy steel					High alloyed steel, and tool steel			Stainless steel			Grey cast iron		Nodular cast iron		Malleable cast iron
VDI 3323	1	2	3	4	5	6	7	8	9	10	11	12	13	14	15	16	17	18	19	20	
HRC		13	25	28	32	10	29	32	38	15	35	15	23	10	10	26	3	25		21	
HB	125	190	250	270	300	180	275	300	350	200	325	200	240	180	180	260	160	250	130	230	
Recommend	○	○	○	◎	◎	○	◎	◎	◎	◎	◎				○	○	○	○	○	○	
ISO Material Description	N					S					H										
	Aluminum-wrought alloy		Aluminum-cast, alloyed			Copper and Copper Alloys (Bronze / Brass)			Non Metallic Materials		Heat Resistant Super Alloys					Titanium Alloys		Hardened steel	Chilled Cast Iron	Hardened Cast Iron	
VDI 3323	21	22	23	24	25	26	27	28	29	30	31	32	33	34	35	36	37	38	39	40	41
HRC											15	30	25	38	34			55	60	42	55
HB	60	100	75	90	130	110	90	100			200	280	250	350	320	400 Rm	1050 Rm	550	630	400	550
Recommend																		○	◎	◎	○

YG 4G MILL END MILLS

PLAIN SHANK

SEM846 SERIES

CARBIDE, 2 FLUTE BALL NOSE with EXTENDED NECK

- **VOLLHARTMETALL, 2 SCHNEIDEN STIRNRADIUS mit LANG ABGESETZTEM SCHAFTTETL**
- **Fraise carbure, 2 dents, hémisphérique, détalonnée**
- **MD, 2 TAGLIANTI, SEMISFERICA, SCARICATA**

- ▶ Due to new coating and new tool geometry, outstanding cutting ability and wear resistance.
- ▶ Due to unique ball nose geometry and cutting edges, cutting force decreased, and so wear resistance increased.
- ▶ Excellent performance when cutting prehardened steels, up to HRc55 which are used for molds & dies.

- ▶ Aufgrund einer neuartigen Beschichtung und neuer Werkzeuggeometrien hervorragende Schnittleistung und Verschleißfestigkeit.
- ▶ Aufgrund der einzigartigen Kugelgeometrie und Schneidkantenpräparation wird die Schnittkraft reduziert und die Verschleißfestigkeit erhöht.
- ▶ Hervorragende Leistung bei der Zerspanung von vorvergüteten Stählen bis HRc55, welche im Werkzeug- und Formenbau Verwendung finden.

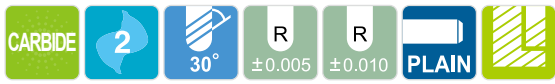
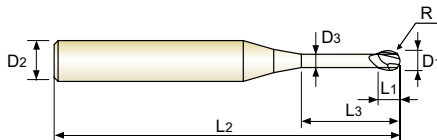

P.278-289

R0.05-R3 R4-R6

Unit : mm

EDP No.	Radius of Ball Nose	Mill Diameter	Shank Diameter	Length of Cut	Length Below Shank	Overall Length	Neck Diameter
	R	D1	D2	L1	L3	L2	D3
★ SEM84601216E	R0.6	1.2	4	1.2	16	50	1.15
SEM84601220E	R0.6	1.2	4	1.2	20	50	1.15
SEM84601226E	R0.6	1.2	4	1.2	26	60	1.15
SEM84601406E	R0.7	1.4	4	1.4	6	50	1.35
SEM84601408E	R0.7	1.4	4	1.4	8	50	1.35
SEM84601410E	R0.7	1.4	4	1.4	10	50	1.35
SEM84601412E	R0.7	1.4	4	1.4	12	50	1.35
SEM84601416E	R0.7	1.4	4	1.4	16	50	1.35
★ SEM84601503E	R0.75	1.5	4	1.5	3	50	1.45
★ SEM84601504E	R0.75	1.5	4	1.5	4	50	1.45
★ SEM84601505E	R0.75	1.5	4	1.5	5	50	1.45
★ SEM84601506E	R0.75	1.5	4	1.5	6	50	1.45
SEM84601507E	R0.75	1.5	4	1.5	7	50	1.45
★ SEM84601508E	R0.75	1.5	4	1.5	8	50	1.45
★ SEM84601510E	R0.75	1.5	4	1.5	10	50	1.45
★ SEM84601512E	R0.75	1.5	4	1.5	12	50	1.45
★ SEM84601514E	R0.75	1.5	4	1.5	14	50	1.45
★ SEM84601516E	R0.75	1.5	4	1.5	16	50	1.45
★ SEM84601518E	R0.75	1.5	4	1.5	18	50	1.45
★ SEM84601520E	R0.75	1.5	4	1.5	20	50	1.45
SEM84601522E	R0.75	1.5	4	1.5	22	60	1.45
SEM84601526E	R0.75	1.5	4	1.5	26	60	1.45
SEM84601530E	R0.75	1.5	4	1.5	30	70	1.45
SEM84601535E	R0.75	1.5	4	1.5	35	70	1.45

★ : Stock Item

▶ NEXT PAGE

Size	Radius Tolerance (mm)	Mill Dia. Tolerance (mm)	Shank Dia. Tolerance
up to R3	± 0.005	0 ~ - 0.012	h5
over R3	± 0.010	0 ~ - 0.015	

◎ : Excellent ○ : Good

ISO Material Description	P											M			K						
	Non-alloy steel					Low alloy steel				High alloyed steel, and tool steel		Stainless steel			Grey cast iron		Nodular cast iron		Malleable cast iron		
VDI 3323	1	2	3	4	5	6	7	8	9	10	11	12	13	14	15	16	17	18	19	20	
HRc		13	25	28	32	10	29	32	38	15	35	15	23	10	10	26	3	25		21	
HB	125	190	250	270	300	180	275	300	350	200	325	200	240	180	180	260	160	250	130	230	
Recommend	○	○	○	◎	◎	○	◎	◎	◎	○	◎	○	○	○	○	○	○	○	○	○	
ISO Material Description	N										S							H			
	Aluminum-wrought alloy		Aluminum-cast, alloyed			Copper and Copper Alloys (Bronze / Brass)			Non Metallic Materials		Heat Resistant Super Alloys					Titanium Alloys		Hardened steel	Chilled Cast Iron	Hardened Cast Iron	
VDI 3323	21	22	23	24	25	26	27	28	29	30	31	32	33	34	35	36	37	38	39	40	41
HRc											15	30	25	38	34			55	60	42	55
HB	60	100	75	90	130	110	90	100			200	280	250	350	320	400 Rm	1050 Rm	550	630	400	550
Recommend											○	○	○	○	○	○	○	○	◎	◎	○

CARBIDE, 2 FLUTE BALL NOSE with EXTENDED NECK

- VOLLHARTMETALL, 2 SCHNEIDEN STIRNRADIUS mit LANG ABGESETZTEM SCHAFTTETTEL
- () Fraise carbure, 2 dents, hémisphérique, détalonnée
- () MD, 2 TAGLIENTI, SEMISFERICA, SCARICATA

- ▶ New coating and tool geometry applied resulting outstanding cutting abilities and wear resistance.
- ▶ With its unique ball nose geometry and cutting edges the cutting force has decreased, also increasing wear resistance.
- ▶ Excellent performance when cutting prehardened steels, up to HRC55 which are used for molds & dies.

- ▶ Aufgrund einer neuartigen Beschichtung und neuer Werkzeuggeometrien hervorragende Schnittleistung und Verschleißfestigkeit.
- ▶ Aufgrund der einzigartigen Kugelgeometrie und Schneidkantenpräparation wird die Schnittkraft reduziert und die Verschleißfestigkeit erhöht.
- ▶ Hervorragende Leistung bei der Zerspaltung von vorvergüteten Stählen bis HRC55, welche im Werkzeug- und Formenbau Verwendung finden.

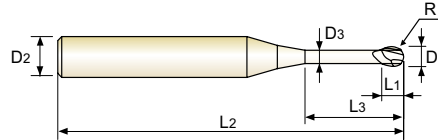

CARBIDE 2 30° ±0.005 ±0.010 PLAIN P.278-289

R0.05-R3 R4-R6

Unit : mm

EDP No.	Radius of Ball Nose	Mill Diameter	Shank Diameter	Length of Cut	Length Below Shank	Overall Length	Neck Diameter
	R	D1	D2	L1	L3	L2	D3
SEM84601540E	R0.75	1.5	4	1.5	40	80	1.45
SEM84601604E	R0.8	1.6	4	1.6	4	50	1.55
SEM84601606E	R0.8	1.6	4	1.6	6	50	1.55
★ SEM84601608E	R0.8	1.6	4	1.6	8	50	1.55
SEM84601610E	R0.8	1.6	4	1.6	10	50	1.55
★ SEM84601612E	R0.8	1.6	4	1.6	12	50	1.55
★ SEM84601616E	R0.8	1.6	4	1.6	16	50	1.55
SEM84601620E	R0.8	1.6	4	1.6	20	50	1.55
★ SEM84601804E	R0.9	1.8	4	1.8	4	50	1.75
SEM84601806E	R0.9	1.8	4	1.8	6	50	1.75
★ SEM84601808E	R0.9	1.8	4	1.8	8	50	1.75
SEM84601810E	R0.9	1.8	4	1.8	10	50	1.75
★ SEM84601812E	R0.9	1.8	4	1.8	12	50	1.75
★ SEM84601816E	R0.9	1.8	4	1.8	16	50	1.75
SEM84601820E	R0.9	1.8	4	1.8	20	50	1.75
★ SEM84602004E	R1.0	2.0	4	2	4	50	1.95
★ SEM84602006E	R1.0	2.0	4	2	6	50	1.95
★ SEM84602008E	R1.0	2.0	4	2	8	50	1.95
★ SEM84602010E	R1.0	2.0	4	2	10	50	1.95
★ SEM84602012E	R1.0	2.0	4	2	12	50	1.95
★ SEM84602014E	R1.0	2.0	4	2	14	50	1.95
★ SEM84602016E	R1.0	2.0	4	2	16	50	1.95
★ SEM84602018E	R1.0	2.0	4	2	18	50	1.95
★ SEM84602020E	R1.0	2.0	4	2	20	50	1.95

★ : Stock Item

▶ NEXT PAGE

Size	Radius Tolerance (mm)	Mill Dia. Tolerance (mm)	Shank Dia. Tolerance
up to R3	± 0.005	0 ~ - 0.012	h5
over R3	± 0.010	0 ~ - 0.015	

◎ : Excellent ○ : Good

ISO Material Description	P										M			K						
	Non-alloy steel					Low alloy steel					High alloyed steel, and tool steel			Stainless steel		Grey cast iron		Nodular cast iron		Malleable cast iron
VDI 3323	1	2	3	4	5	6	7	8	9	10	11	12	13	14	15	16	17	18	19	20
HRC	13	25	28	32	10	29	32	38	15	35	15	23	10	10	26	3	25	42	21	
HB	125	190	250	270	300	180	275	300	350	200	325	200	240	180	180	260	160	250	130	230
Recommend	○	○	○	◎	◎	○	◎	◎	◎	◎	◎	◎	◎	○	○	○	○	○	○	

ISO Material Description	N					S					H										
	Aluminum-wrought alloy		Aluminum-cast, alloyed		Copper and Copper Alloys (Bronze / Brass)		Non Metallic Materials		Heat Resistant Super Alloys			Titanium Alloys		Hardened steel	Chilled Cast Iron	Hardened Cast Iron					
VDI 3323	21	22	23	24	25	26	27	28	29	30	31	32	33	34	35	36	37	38	39	40	41
HRC	60	100	75	90	130	110	90	100			15	30	25	38	34	36	37	55	60	42	55
HB	60	100	75	90	130	110	90	100			200	280	250	350	320	400 Rm	1050 Rm	550	630	400	550
Recommend																		○	◎	○	○

YG 4G MILL END MILLS

PLAIN SHANK

SEM846 SERIES

CARBIDE, 2 FLUTE BALL NOSE with EXTENDED NECK

- **VOLLHARTMETALL, 2 SCHNEIDEN STIRNRADIUS mit LANG ABGESETZTEM SCHAFTTETL**
- **Fraise carbure, 2 dents, hémisphérique, détalonnée**
- **MD, 2 TAGLIANTI, SEMISFERICA, SCARICATA**

- ▶ New coating and tool geometry applied resulting outstanding cutting abilities and wear resistance.
- ▶ With its unique ball nose geometry and cutting edges the cutting force has decreased, also increasing wear resistance.
- ▶ Excellent performance when cutting prehardened steels, up to HRc55 which are used for molds & dies.

- ▶ Aufgrund einer neuartigen Beschichtung und neuer Werkzeuggeometrien hervorragende Schnittleistung und Verschleißfestigkeit.
- ▶ Aufgrund der einzigartigen Kugelgeometrie und Schneidkantenpräparation wird die Schnittkraft reduziert und die Verschleißfestigkeit erhöht.
- ▶ Hervorragende Leistung bei der Zerspaltung von vorvergüteten Stählen bis HRc55, welche im Werkzeug- und Formenbau Verwendung finden.

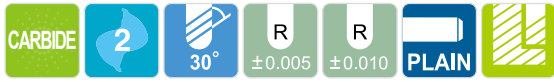
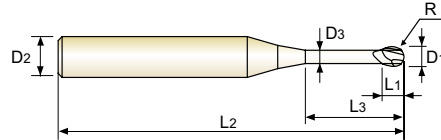

P.278-289

R0.05-R3 R4-R6

Unit : mm

EDP No.	Radius of Ball Nose	Mill Diameter	Shank Diameter	Length of Cut	Length Below Shank	Overall Length	Neck Diameter
	R	D1	D2	L1	L3	L2	D3
SEM84602022E	R1.0	2.0	4	2	22	60	1.95
★ SEM84602026E	R1.0	2.0	4	2	26	60	1.95
★ SEM84602030E	R1.0	2.0	4	2	30	70	1.95
★ SEM84602035E	R1.0	2.0	4	2	35	70	1.95
SEM84602040E	R1.0	2.0	4	2	40	80	1.95
SEM84602045E	R1.0	2.0	4	2	45	90	1.95
SEM84602050E	R1.0	2.0	4	2	50	100	1.95
SEM84602060E	R1.0	2.0	4	2	60	110	1.95
★ SEM84602508E	R1.25	2.5	4	2.5	8	50	2.40
★ SEM84602510E	R1.25	2.5	4	2.5	10	50	2.40
★ SEM84602512E	R1.25	2.5	4	2.5	12	50	2.40
★ SEM84602516E	R1.25	2.5	4	2.5	16	50	2.40
★ SEM84602520E	R1.25	2.5	4	2.5	20	50	2.40
SEM84602522E	R1.25	2.5	4	2.5	22	60	2.40
SEM84602526E	R1.25	2.5	4	2.5	26	60	2.40
SEM84602530E	R1.25	2.5	4	2.5	30	70	2.40
SEM84602535E	R1.25	2.5	4	2.5	35	70	2.40
SEM84602540E	R1.25	2.5	4	2.5	40	80	2.40
SEM84602545E	R1.25	2.5	4	2.5	45	90	2.40
SEM84602550E	R1.25	2.5	4	2.5	50	100	2.40
★ SEM84603006E	R1.5	3.0	6	3	6	50	2.85
★ SEM84603008E	R1.5	3.0	6	3	8	50	2.85
★ SEM84603010E	R1.5	3.0	6	3	10	50	2.85
★ SEM84603012E	R1.5	3.0	6	3	12	50	2.85

★ : Stock Item

▶ NEXT PAGE

Size	Radius Tolerance (mm)	Mill Dia. Tolerance (mm)	Shank Dia. Tolerance
up to R3	± 0.005	0 ~ - 0.012	h5
over R3	± 0.010	0 ~ - 0.015	

◎ : Excellent ○ : Good

ISO Material Description	P											M			K						
	Non-alloy steel					Low alloy steel				High alloyed steel, and tool steel		Stainless steel			Grey cast iron		Nodular cast iron		Malleable cast iron		
VDI 3323	1	2	3	4	5	6	7	8	9	10	11	12	13	14	15	16	17	18	19	20	
HRc		13	25	28	32	10	29	32	38	15	35	15	23	10	10	26	3	25		21	
HB	125	190	250	270	300	180	275	300	350	200	325	200	240	180	180	260	160	250	130	230	
Recommend	○	○	○	◎	◎	◎	◎	◎	◎	○	◎	○	○	○	○	○	○	○	○	○	
ISO Material Description	N										S						H				
	Aluminum-wrought alloy		Aluminum-cast, alloyed			Copper and Copper Alloys (Bronze / Brass)			Non Metallic Materials		Heat Resistant Super Alloys				Titanium Alloys		Hardened steel	Chilled Cast Iron	Hardened Cast Iron		
VDI 3323	21	22	23	24	25	26	27	28	29	30	31	32	33	34	35	36	37	38	39	40	41
HRc											15	30	25	38	34			55	60	42	55
HB	60	100	75	90	130	110	90	100			200	280	250	350	320	400 Rm	1050 Rm	550	630	400	550
Recommend											○	○	○	○	○	○	○	○	○	◎	○

CARBIDE, 2 FLUTE BALL NOSE with EXTENDED NECK

- VOLLHARTMETALL, 2 SCHNEIDEN STIRNRADIUS mit LANG ABGESETZTEM SCHAFTTETTEL
- () Fraise carbure, 2 dents, hémisphérique, détalonnée
- () MD, 2 TAGLIENTI, SEMISFERICA, SCARICATA

- ▶ New coating and tool geometry applied resulting outstanding cutting abilities and wear resistance.
- ▶ With its unique ball nose geometry and cutting edges the cutting force has decreased, also increasing wear resistance.
- ▶ Excellent performance when cutting prehardened steels, up to HRC55 which are used for molds & dies.

- ▶ Aufgrund einer neuartigen Beschichtung und neuer Werkzeuggeometrien hervorragende Schnittleistung und Verschleißfestigkeit.
- ▶ Aufgrund der einzigartigen Kugelgeometrie und Schneidkantenpräparation wird die Schnittkraft reduziert und die Verschleißfestigkeit erhöht.
- ▶ Hervorragende Leistung bei der Zerspaltung von vorvergüteten Stählen bis HRC55, welche im Werkzeug- und Formenbau Verwendung finden.

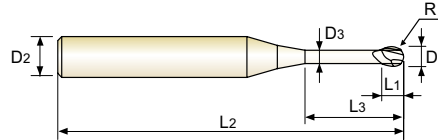

CARBIDE 2 30° ±0.005 ±0.010 PLAIN P.278-289

R0.05-R3 R4-R6

Unit : mm

EDP No.	Radius of Ball Nose	Mill Diameter	Shank Diameter	Length of Cut	Length Below Shank	Overall Length	Neck Diameter
	R	D1	D2	L1	L3	L2	D3
★ SEM84603014E	R1.5	3.0	6	3	14	60	2.85
SEM84603015E	R1.5	3.0	6	3	15	60	2.85
★ SEM84603016E	R1.5	3.0	6	3	16	60	2.85
★ SEM84603018E	R1.5	3.0	6	3	18	60	2.85
★ SEM84603020E	R1.5	3.0	6	3	20	60	2.85
★ SEM84603022E	R1.5	3.0	6	3	22	65	2.85
★ SEM84603026E	R1.5	3.0	6	3	26	65	2.85
★ SEM84603030E	R1.5	3.0	6	3	30	70	2.85
★ SEM84603035E	R1.5	3.0	6	3	35	70	2.85
★ SEM84603040E	R1.5	3.0	6	3	40	80	2.85
★ SEM84603045E	R1.5	3.0	6	3	45	90	2.85
★ SEM84603050E	R1.5	3.0	6	3	50	100	2.85
SEM84603060E	R1.5	3.0	6	3	60	100	2.85
★ SEM84604008E	R2.0	4.0	6	4	8	50	3.85
★ SEM84604010E	R2.0	4.0	6	4	10	50	3.85
★ SEM84604012E	R2.0	4.0	6	4	12	50	3.85
★ SEM84604014E	R2.0	4.0	6	4	14	60	3.85
★ SEM84604016E	R2.0	4.0	6	4	16	60	3.85
★ SEM84604018E	R2.0	4.0	6	4	18	60	3.85
★ SEM84604020E	R2.0	4.0	6	4	20	60	3.85
★ SEM84604022E	R2.0	4.0	6	4	22	65	3.85
★ SEM84604026E	R2.0	4.0	6	4	26	65	3.85
★ SEM84604030E	R2.0	4.0	6	4	30	70	3.85
★ SEM84604035E	R2.0	4.0	6	4	35	70	3.85

★ : Stock Item

▶ NEXT PAGE

Size	Radius Tolerance (mm)	Mill Dia. Tolerance (mm)	Shank Dia. Tolerance
up to R3	± 0.005	0 ~ - 0.012	h5
over R3	± 0.010	0 ~ - 0.015	

◎ : Excellent ○ : Good

ISO Material Description	P										M			K							
	Non-alloy steel					Low alloy steel					High alloyed steel, and tool steel			Stainless steel			Grey cast iron		Nodular cast iron		Malleable cast iron
VDI 3323	1	2	3	4	5	6	7	8	9	10	11	12	13	14	15	16	17	18	19	20	
HRC		13	25	28	32	10	29	32	38	15	35	15	23	10	10	26	3	25		21	
HB	125	190	250	270	300	180	275	300	350	200	325	200	240	180	180	260	160	250	130	230	
Recommend	○	○	○	◎	◎	○	◎	◎	◎	◎	◎	○	○	○	○	○	○	○	○	○	
ISO Material Description	N					S					H										
	Aluminum-wrought alloy		Aluminum-cast, alloyed			Copper and Copper Alloys (Bronze / Brass)			Non Metallic Materials		Heat Resistant Super Alloys			Titanium Alloys		Hardened steel		Chilled Cast Iron		Hardened Cast Iron	
VDI 3323	21	22	23	24	25	26	27	28	29	30	31	32	33	34	35	36	37	38	39	40	41
HRC											15	30	25	38	34			55	60	42	55
HB	60	100	75	90	130	110	90	100			200	280	250	350	320	400 Rm	1050 Rm	550	630	400	550
Recommend																		○	◎	○	○

YG 4G MILL END MILLS

PLAIN SHANK

SEM846 SERIES

CARBIDE, 2 FLUTE BALL NOSE with EXTENDED NECK

- **VOLLHARTMETALL, 2 SCHNEIDEN STIRNRADIUS mit LANG ABGESETZTEM SCHAFTTETL**
- **Fraise carbure, 2 dents, hémisphérique, détalonnée**
- **MD, 2 TAGLIANTI, SEMISFERICA, SCARICATA**

- ▶ New coating and tool geometry applied resulting outstanding cutting abilities and wear resistance.
- ▶ With its unique ball nose geometry and cutting edges the cutting force has decreased, also increasing wear resistance.
- ▶ Excellent performance when cutting prehardened steels, up to HRc55 which are used for molds & dies.

- ▶ Aufgrund einer neuartigen Beschichtung und neuer Werkzeuggeometrien hervorragende Schnittleistung und Verschleißfestigkeit.
- ▶ Aufgrund der einzigartigen Kugelgeometrie und Schneidkantenpräparation wird die Schnittkraft reduziert und die Verschleißfestigkeit erhöht.
- ▶ Hervorragende Leistung bei der Zerspaltung von vorvergüteten Stählen bis HRc55, welche im Werkzeug- und Formenbau Verwendung finden.

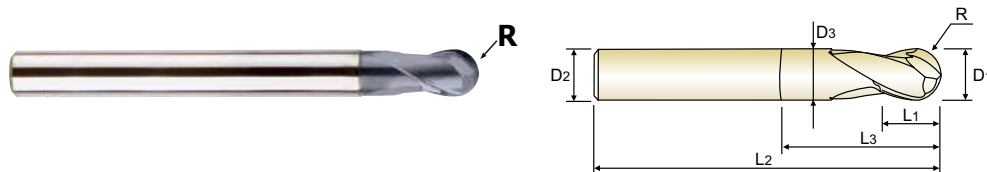

CARBIDE
2
30°
R ±0.005
R ±0.010
PLAIN
P.278-289

R0.05-R3 R4-R6

Unit : mm

EDP No.	Radius of Ball Nose	Mill Diameter	Shank Diameter	Length of Cut	Length Below Shank	Overall Length	Neck Diameter
	R	D1	D2	L1	L3	L2	D3
★ SEM84604040E	R2.0	4.0	6	4	40	80	3.85
SEM84604045E	R2.0	4.0	6	4	45	90	3.85
★ SEM84604050E	R2.0	4.0	6	4	50	100	3.85
SEM84604055E	R2.0	4.0	6	4	55	100	3.85
SEM84604060E	R2.0	4.0	6	4	60	100	3.85
SEM84605015E	R2.5	5.0	6	6	15	60	4.85
★ SEM84605020E	R2.5	5.0	6	6	20	60	4.85
★ SEM84605026E	R2.5	5.0	6	6	26	65	4.85
★ SEM84605030E	R2.5	5.0	6	6	30	70	4.85
★ SEM84605035E	R2.5	5.0	6	6	35	70	4.85
★ SEM84605040E	R2.5	5.0	6	6	40	80	4.85
SEM84605045E	R2.5	5.0	6	6	45	90	4.85
★ SEM84605050E	R2.5	5.0	6	6	50	100	4.85
SEM84605055E	R2.5	5.0	6	6	55	100	4.85
SEM84605060E	R2.5	5.0	6	6	60	100	4.85
★ SEM84606020E	R3.0	6.0	6	8	20	60	5.85
★ SEM84606030E	R3.0	6.0	6	8	30	60	5.85
★ SEM84606020090E	R3.0	6.0	6	12	20	90	5.85
★ SEM84606030090E	R3.0	6.0	6	12	30	90	5.85
★ SEM84608025E	R4.0	8.0	8	10	25	70	7.70
★ SEM84608035E	R4.0	8.0	8	10	35	70	7.70
SEM84608025100E	R4.0	8.0	8	14	25	100	7.70
★ SEM84608035100E	R4.0	8.0	8	14	35	100	7.70
★ SEM84610030E	R5.0	10.0	10	12	30	75	9.70

★ : Stock Item

▶ NEXT PAGE

Size	Radius Tolerance (mm)	Mill Dia. Tolerance (mm)	Shank Dia. Tolerance
up to R3	± 0.005	0 ~ - 0.012	h5
over R3	± 0.010	0 ~ - 0.015	

◎ : Excellent ○ : Good

ISO Material Description	P										M				K								
	Non-alloy steel					Low alloy steel					High alloyed steel, and tool steel				Stainless steel				Grey cast iron		Nodular cast iron		Malleable cast iron
VDI 3323	1	2	3	4	5	6	7	8	9	10	11	12	13	14	15	16	17	18	19	20			
HRc		13	25	28	32	10	29	32	38	15	35	15	23	10	10	26	3	25		21			
HB	125	190	250	270	300	180	275	300	350	200	325	200	240	180	180	260	160	250	130	230			
Recommend	○	○	○	◎	◎	○	◎	◎	◎	○	◎	○	○	○	○	○	○	○	○	○			
ISO Material Description	N										S							H					
	Aluminum-wrought alloy		Aluminum-cast, alloyed			Copper and Copper Alloys (Bronze / Brass)			Non Metallic Materials		Heat Resistant Super Alloys				Titanium Alloys			Hardened steel	Chilled Cast Iron	Hardened Cast Iron			
VDI 3323	21	22	23	24	25	26	27	28	29	30	31	32	33	34	35	36	37	38	39	40	41		
HRc											15	30	25	38	34			55	60	42	55		
HB	60	100	75	90	130	110	90	100			200	280	250	350	320	400 Rm	1050 Rm	550	630	400	550		
Recommend											○	○	○	○	○	○	○	○	◎	◎	○		

CARBIDE, 2 FLUTE BALL NOSE with EXTENDED NECK

- VOLLHARTMETALL, 2 SCHNEIDEN STIRNRADIUS mit LANG ABGESETZTEM SCHAFTTETL
- () Fraise carbure, 2 dents, hémisphérique, détalonnée
- () MD, 2 TAGLIENTI, SEMISFERICA, SCARICATA

- ▶ New coating and tool geometry applied resulting outstanding cutting abilities and wear resistance.
- ▶ With its unique ball nose geometry and cutting edges the cutting force has decreased, also increasing wear resistance.
- ▶ Excellent performance when cutting prehardened steels, up to HRC55 which are used for molds & dies.

- ▶ Aufgrund einer neuartigen Beschichtung und neuer Werkzeuggeometrien hervorragende Schnittleistung und Verschleißfestigkeit.
- ▶ Aufgrund der einzigartigen Kugelgeometrie und Schneidkantenpräparation wird die Schnittkraft reduziert und die Verschleißfestigkeit erhöht.
- ▶ Hervorragende Leistung bei der Zerspaltung von vorvergüteten Stählen bis HRC55, welche im Werkzeug- und Formenbau Verwendung finden.

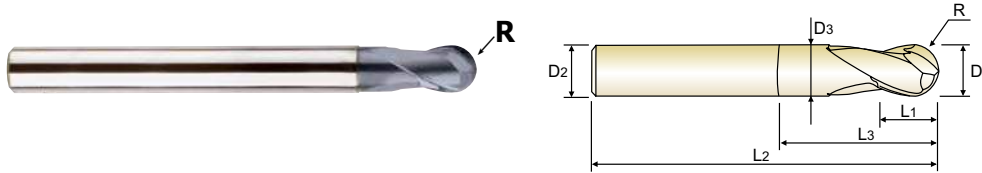

CARBIDE 2 30° ±0.005 ±0.010 PLAIN P.278-289

EDP No.	Radius of Ball Nose	Mill Diameter	Shank Diameter	Length of Cut	Length Below Shank	Overall Length	Neck Diameter
	R	D1	D2	L1	L3	L2	D3
★ SEM84610040E	R5.0	10.0	10	12	40	75	9.70
★ SEM84610030100E	R5.0	10.0	10	18	30	100	9.70
★ SEM84610040100E	R5.0	10.0	10	18	40	100	9.70
★ SEM84612032E	R6.0	12.0	12	14	32	80	11.70
SEM84612045E	R6.0	12.0	12	14	45	80	11.70
★ SEM84612032110E	R6.0	12.0	12	22	32	110	11.70
★ SEM84612045110E	R6.0	12.0	12	22	45	110	11.70

★ : Stock Item

Size	Radius Tolerance (mm)	Mill Dia. Tolerance (mm)	Shank Dia. Tolerance
up to R3	± 0.005	0 ~ - 0.012	h5
over R3	± 0.010	0 ~ - 0.015	

◎ : Excellent ○ : Good

ISO Material Description	P										M			K						
	Non-alloy steel					Low alloy steel					Stainless steel			Grey cast iron		Nodular cast iron		Malleable cast iron		
VDI 3323	1	2	3	4	5	6	7	8	9	10	11	12	13	14	15	16	17	18	19	20
HRC	13	19	25	28	32	10	29	32	38	10	35	15	23	10	10	26	3	25	130	21
HB	125	190	250	270	300	180	275	300	350	200	325	200	240	180	180	260	160	250	130	230
Recommend	○	○	○	◎	◎	○	◎	◎	◎	○	◎				○	○	○	○	○	○

ISO Material Description	N					S					H										
	Aluminum-wrought alloy		Aluminum-cast, alloyed			Copper and Copper Alloys (Bronze / Brass)		Non Metallic Materials			Heat Resistant Super Alloys			Titanium Alloys		Hardened steel	Chilled Cast Iron	Hardened Cast Iron			
VDI 3323	21	22	23	24	25	26	27	28	29	30	31	32	33	34	35	36	37	38	39	40	41
HRC	60	100	75	90	130	110	90	100			15	30	25	38	34	400 Rm	1050 Rm	55	60	42	55
HB	60	100	75	90	130	110	90	100			200	280	250	350	320	400 Rm	1050 Rm	550	630	400	550
Recommend																		○	◎	○	○

CARBIDE, 2 FLUTE BALL NOSE with EXTENDED NECK (6mm shank)

- **VOLLHARTMETALL, 2 SCHNEIDEN STIRNRADIUS mit ABGESETZTEM SCHAFTTETL (6mm ZYLINDERSCHAFT)**
- **Fraise carbure, 2 dents, hémisphérique, détalonnée (Ø queue 6mm)**
- **MD, 2 TAGLIANTI, SEMISFERICA, SCARICATA (gambo 6mm)**

- ▶ New coating and tool geometry applied resulting outstanding cutting abilities and wear resistance.
- ▶ With its unique ball nose geometry and cutting edges the cutting force has decreased, also increasing wear resistance.
- ▶ Excellent performance when cutting prehardened steels, up to HRc55 which are used for molds & dies.

- ▶ Aufgrund einer neuartigen Beschichtung und neuer Werkzeuggeometrien hervorragende Schnittleistung und Verschleißfestigkeit.
- ▶ Aufgrund der einzigartigen Kugelgeometrie und Schneidkantenpräparation wird die Schnittkraft reduziert und die Verschleißfestigkeit erhöht.
- ▶ Hervorragende Leistung bei der Zerspaltung von vorvergüteten Stählen bis HRc55, welche im Werkzeug- und Formenbau Verwendung finden.

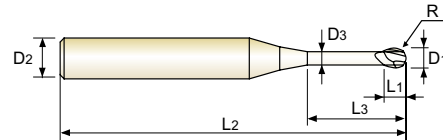

CARBIDE 2 30° ±0.005 PLAIN P.278-289

EDP No.	Radius of Ball Nose	Mill Diameter	Shank Diameter	Length of Cut	Length Below Shank	Overall Length	Neck Diameter
	R	D1	D2	L1	L3	L2	D3
SEM846005016SE	R0.25	0.5	6	0.5	1	45	0.45
SEM846005026SE	R0.25	0.5	6	0.5	2	45	0.45
SEM846005046SE	R0.25	0.5	6	0.5	4	45	0.45
SEM846006016SE	R0.3	0.6	6	0.6	1	45	0.55
SEM846006026SE	R0.3	0.6	6	0.6	2	45	0.55
SEM846006036SE	R0.3	0.6	6	0.6	3	45	0.55
SEM846006046SE	R0.3	0.6	6	0.6	4	45	0.55
SEM846006056SE	R0.3	0.6	6	0.6	5	45	0.55
★ SEM846006066SE	R0.3	0.6	6	0.6	6	45	0.55
SEM846006086SE	R0.3	0.6	6	0.6	8	45	0.55
SEM846006106SE	R0.3	0.6	6	0.6	10	45	0.55
SEM846006126SE	R0.3	0.6	6	0.6	12	45	0.55
SEM846006146SE	R0.3	0.6	6	0.6	14	45	0.55
SEM846006166SE	R0.3	0.6	6	0.6	16	45	0.55
SEM846008016SE	R0.4	0.8	6	0.8	1	45	0.75
SEM846008026SE	R0.4	0.8	6	0.8	2	45	0.75
SEM846008036SE	R0.4	0.8	6	0.8	3	45	0.75
SEM846008046SE	R0.4	0.8	6	0.8	4	45	0.75
SEM846008056SE	R0.4	0.8	6	0.8	5	45	0.75
SEM846008066SE	R0.4	0.8	6	0.8	6	45	0.75
SEM846008086SE	R0.4	0.8	6	0.8	8	45	0.75
SEM846008106SE	R0.4	0.8	6	0.8	10	45	0.75
SEM846008126SE	R0.4	0.8	6	0.8	12	45	0.75
SEM846008146SE	R0.4	0.8	6	0.8	14	45	0.75

★ : Stock Item

▶ NEXT PAGE

Radius Tolerance (mm)	Mill Dia. Tolerance (mm)	Shank Dia. Tolerance
± 0.005	0 ~ - 0.012	h5

◎ : Excellent ○ : Good

ISO Material Description	P										M				K						
	Non-alloy steel					Low alloy steel					High alloyed steel, and tool steel		Stainless steel		Grey cast iron		Nodular cast iron		Malleable cast iron		
VDI 3323	1	2	3	4	5	6	7	8	9	10	11	12	13	14	15	16	17	18	19	20	
HRc		13	25	28	32	10	29	32	38	15	35	15	23	10	10	26	3	25		21	
HB	125	190	250	270	300	180	275	300	350	200	325	200	240	180	180	260	160	250	130	230	
Recommend	○	○	○	◎	◎	○	◎	◎	◎	○	◎	○	○	○	○	○	○	○	○	○	
ISO Material Description	N										S							H			
	Aluminum-wrought alloy		Aluminum-cast, alloyed			Copper and Copper Alloys (Bronze / Brass)			Non Metallic Materials		Heat Resistant Super Alloys					Titanium Alloys		Hardened steel	Chilled Cast Iron	Hardened Cast Iron	
VDI 3323	21	22	23	24	25	26	27	28	29	30	31	32	33	34	35	36	37	38	39	40	41
HRc											15	30	25	38	34			55	60	42	55
HB	60	100	75	90	130	110	90	100			200	280	250	350	320	400 Rm	1050 Rm	550	630	400	550
Recommend											○	○	○	○	○	○	○	○	◎	◎	○



4G MILL END MILLS

PLAIN SHANK

SEM846 SERIES

CARBIDE, 2 FLUTE BALL NOSE with EXTENDED NECK (6mm shank)

- VOLLHARTMETALL, 2 SCHNEIDEN STIRNRADIUS mit ABGESETZTEM SCHAFTTETL (6mm ZYLINDERSCHAFT)
- () Fraise carbure, 2 dents, hémisphérique, détalonnée (Ø queue 6mm)
- () MD, 2 TAGLIENTI, SEMISFERICA, SCARICATA (gambo 6mm)

- ▶ New coating and tool geometry applied resulting outstanding cutting abilities and wear resistance.
- ▶ With its unique ball nose geometry and cutting edges the cutting force has decreased, also increasing wear resistance.
- ▶ Excellent performance when cutting prehardened steels, up to HRC55 which are used for molds & dies.

- ▶ Aufgrund einer neuartigen Beschichtung und neuer Werkzeuggeometrien hervorragende Schnittleistung und Verschleißfestigkeit.
- ▶ Aufgrund der einzigartigen Kugelgeometrie und Schneidkantenpräparation wird die Schnittkraft reduziert und die Verschleißfestigkeit erhöht.
- ▶ Hervorragende Leistung bei der Zerspaltung von vorvergüteten Stählen bis HRC55, welche im Werkzeug- und Formenbau Verwendung finden.

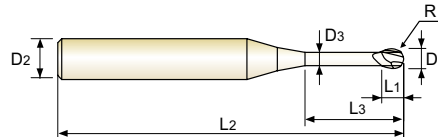

P.278-289

Unit : mm

EDP No.	Radius of Ball Nose	Mill Diameter	Shank Diameter	Length of Cut	Length Below Shank	Overall Length	Neck Diameter
	R	D1	D2	L1	L3	L2	D3
SEM846008166SE	R0.4	0.8	6	0.8	16	45	0.75
SEM846008206SE	R0.4	0.8	6	0.8	20	45	0.75
SEM846010026SE	R0.5	1.0	6	1	2	50	0.95
SEM846010036SE	R0.5	1.0	6	1	3	50	0.95
★ SEM846010046SE	R0.5	1.0	6	1	4	50	0.95
SEM846010056SE	R0.5	1.0	6	1	5	50	0.95
★ SEM846010066SE	R0.5	1.0	6	1	6	50	0.95
SEM846010076SE	R0.5	1.0	6	1	7	50	0.95
SEM846010086SE	R0.5	1.0	6	1	8	50	0.95
SEM846010096SE	R0.5	1.0	6	1	9	50	0.95
★ SEM846010106SE	R0.5	1.0	6	1	10	50	0.95
SEM846010126SE	R0.5	1.0	6	1	12	50	0.95
SEM846010146SE	R0.5	1.0	6	1	14	50	0.95
SEM846010166SE	R0.5	1.0	6	1	16	50	0.95
SEM846010186SE	R0.5	1.0	6	1	18	50	0.95
SEM846010206SE	R0.5	1.0	6	1	20	50	0.95
SEM846010226SE	R0.5	1.0	6	1	22	60	0.95
SEM846010266SE	R0.5	1.0	6	1	26	60	0.95
SEM846010306SE	R0.5	1.0	6	1	30	70	0.95
SEM846015036SE	R0.75	1.5	6	1.5	3	50	1.45
SEM846015046SE	R0.75	1.5	6	1.5	4	50	1.45
★ SEM846015066SE	R0.75	1.5	6	1.5	6	50	1.45
★ SEM846015086SE	R0.75	1.5	6	1.5	8	50	1.45
★ SEM846015106SE	R0.75	1.5	6	1.5	10	50	1.45

★ : Stock Item

▶ NEXT PAGE

Radius Tolerance (mm)	Mill Dia. Tolerance (mm)	Shank Dia. Tolerance
± 0.005	0 ~ - 0.012	h5

◎ : Excellent ○ : Good

ISO Material Description	P										M				K						
	Non-alloy steel					Low alloy steel					High alloyed steel, and tool steel				Stainless steel		Grey cast iron		Nodular cast iron		Malleable cast iron
VDI 3323	1	2	3	4	5	6	7	8	9	10	11	12	13	14	15	16	17	18	19	20	
HRC	13	25	28	32	10	29	32	38	15	35	15	23	10	10	26	3	25	42	21		
HB	125	190	250	270	300	180	275	300	350	200	325	200	240	180	180	260	160	250	130	230	
Recommend	○	○	○	◎	◎	○	◎	◎	◎	◎	◎	◎	◎	◎	◎	○	○	○	○	○	○
ISO Material Description	N										S						H				
	Aluminum-wrought alloy		Aluminum-cast, alloyed			Copper and Copper Alloys (Bronze / Brass)			Non Metallic Materials		Heat Resistant Super Alloys						Titanium Alloys		Hardened steel	Chilled Cast Iron	Hardened Cast Iron
VDI 3323	21	22	23	24	25	26	27	28	29	30	31	32	33	34	35	36	37	38	39	40	41
HRC	21	22	23	24	25	26	27	28	29	30	31	32	33	34	35	36	37	55	60	42	55
HB	60	100	75	90	130	110	90	100			200	280	250	350	320	400 Rm	1050 Rm	550	630	400	550
Recommend																		○	◎	◎	○

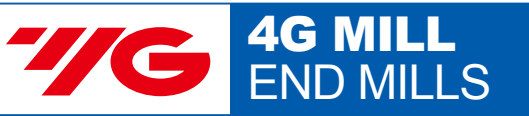

CARBIDE, 2 FLUTE BALL NOSE with EXTENDED NECK (6mm shank)

- **VOLLHARTMETALL, 2 SCHNEIDEN STIRNRADIUS mit ABGESETZTEM SCHAFTTETL (6mm ZYLINDERSCHAFT)**
- **Fraise carbure, 2 dents, hémisphérique, détalonnée (Ø queue 6mm)**
- **MD, 2 TAGLIANTI, SEMISFERICA, SCARICATA (gambo 6mm)**

- ▶ New coating and tool geometry applied resulting outstanding cutting abilities and wear resistance.
- ▶ With its unique ball nose geometry and cutting edges the cutting force has decreased, also increasing wear resistance.
- ▶ Excellent performance when cutting prehardened steels, up to HRc55 which are used for molds & dies.

- ▶ Aufgrund einer neuartigen Beschichtung und neuer Werkzeuggeometrien hervorragende Schnittleistung und Verschleißfestigkeit.
- ▶ Aufgrund der einzigartigen Kugelgeometrie und Schneidkantenpräparation wird die Schnittkraft reduziert und die Verschleißfestigkeit erhöht.
- ▶ Hervorragende Leistung bei der Zerspaltung von vorvergüteten Stählen bis HRc55, welche im Werkzeug- und Formenbau Verwendung finden.

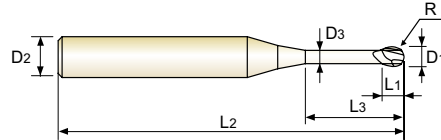

CARBIDE 2 30° ±0.005 PLAIN P.278-289

EDP No.	Radius of Ball Nose	Mill Diameter	Shank Diameter	Length of Cut	Length Below Shank	Overall Length	Neck Diameter
	R	D1	D2	L1	L3	L2	D3
★ SEM846015126SE	R0.75	1.5	6	1.5	12	50	1.45
SEM846015146SE	R0.75	1.5	6	1.5	14	50	1.45
SEM846015166SE	R0.75	1.5	6	1.5	16	50	1.45
SEM846015186SE	R0.75	1.5	6	1.5	18	50	1.45
SEM846015206SE	R0.75	1.5	6	1.5	20	50	1.45
SEM846015226SE	R0.75	1.5	6	1.5	22	60	1.45
SEM846015266SE	R0.75	1.5	6	1.5	26	60	1.45
SEM846015306SE	R0.75	1.5	6	1.5	30	70	1.45
SEM846015356SE	R0.75	1.5	6	1.5	35	70	1.45
SEM846015406SE	R0.75	1.5	6	1.5	40	80	1.45
SEM846020046SE	R1.0	2.0	6	2	4	50	1.95
★ SEM846020066SE	R1.0	2.0	6	2	6	50	1.95
★ SEM846020086SE	R1.0	2.0	6	2	8	50	1.95
★ SEM846020106SE	R1.0	2.0	6	2	10	50	1.95
★ SEM846020126SE	R1.0	2.0	6	2	12	50	1.95
SEM846020146SE	R1.0	2.0	6	2	14	50	1.95
★ SEM846020166SE	R1.0	2.0	6	2	16	50	1.95
SEM846020186SE	R1.0	2.0	6	2	18	50	1.95
★ SEM846020206SE	R1.0	2.0	6	2	20	50	1.95
SEM846020226SE	R1.0	2.0	6	2	22	60	1.95
SEM846020266SE	R1.0	2.0	6	2	26	60	1.95
SEM846020306SE	R1.0	2.0	6	2	30	70	1.95
SEM846020356SE	R1.0	2.0	6	2	35	70	1.95
SEM846020406SE	R1.0	2.0	6	2	40	80	1.95
SEM846020456SE	R1.0	2.0	6	2	45	90	1.95
SEM846020506SE	R1.0	2.0	6	2	50	100	1.95

★ : Stock Item

Radius Tolerance (mm)	Mill Dia. Tolerance (mm)	Shank Dia. Tolerance
± 0.005	0 ~ - 0.012	h5

◎ : Excellent ○ : Good

ISO Material Description	P									M				K							
	Non-alloy steel					Low alloy steel				High alloyed steel, and tool steel		Stainless steel		Grey cast iron		Nodular cast iron		Malleable cast iron			
VDI 3323	1	2	3	4	5	6	7	8	9	10	11	12	13	14	15	16	17	18	19	20	
HRc		13	25	28	32	10	29	32	38	15	35	15	23	10	10	26	3	25		21	
HB	125	190	250	270	300	180	275	300	350	200	325	200	240	180	180	260	160	250	130	230	
Recommend	○	○	○	◎	◎	○	◎	◎	◎	○	◎	○	○	○	○	○	○	○	○	○	
ISO Material Description	N					S					H										
	Aluminum-wrought alloy		Aluminum-cast, alloyed			Copper and Copper Alloys (Bronze / Brass)			Non Metallic Materials		Heat Resistant Super Alloys			Titanium Alloys		Hardened steel		Chilled Cast Iron	Hardened Cast Iron		
VDI 3323	21	22	23	24	25	26	27	28	29	30	31	32	33	34	35	36	37	38	39	40	41
HRc											15	30	25	38	34			55	60	42	55
HB	60	100	75	90	130	110	90	100			200	280	250	350	320	400 Rm	1050 Rm	550	630	400	550
Recommend											○	○	○	○	○	○	○	○	◎	◎	○

CARBIDE, 2 FLUTE CORNER RADIUS (Short, Regular, Long Shank)

- **VOLLHARTMETALL, 2 SCHNEIDEN ECKENRADIUS**
- (●) **Fraise carbure, 2 dents, torique**
- (●) **MD, 2 TAGLIENTI, TORICA (Serie corta, media e lunga)**

- ▶ New coating and tool geometry applied resulting outstanding cutting abilities and wear resistance.
- ▶ Excellent for cutting prehardened steels, carbon steels, alloy steels of molds and dies, up to HRC55 and machine parts.
- ▶ Available in short, regular and long shank end mills.
- ▶ Available with various corner radius end mills, from 0.02mm to 5.0mm corner radius.

- ▶ Aufgrund einer neuartigen Beschichtung und neuer Werkzeuggeometrien hervorragende Schnittleistung und Verschleißfestigkeit
- ▶ Ausgezeichnet geeignet für das Fräsen von vorvergütetem Stahl, kohlenstoff Stahl, legiertem Stahl für Formen, bis HRC55 und Maschinenbauteile.
- ▶ Erhältlich in den Schaft-Ausführungen: kurz, standard und lang
- ▶ Erhältlich in verschiedenen Eckradien-Ausführungen: von 0,02mm bis zu 5,0mm Eckradius.

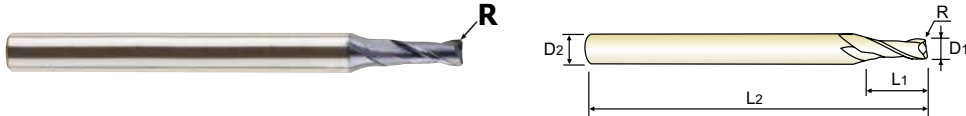

CARBIDE
2
30°
±0.010
±0.015
PLAIN
P.290-291

Ø0.2-Ø6 Ø7-Ø20

Unit : mm

EDP No.	Corner Radius	Mill Diameter	Shank Diameter	Length of Cut	Overall Length	Remark
	R	D1	D2	L1	L2	
SEMD99002002E	R0.02	0.2	4	0.4	40	-
SEMD99002005E	R0.05	0.2	4	0.4	40	-
SEMD99003002E	R0.02	0.3	4	0.6	40	-
SEMD99003005E	R0.05	0.3	4	0.6	40	-
SEMD99004005E	R0.05	0.4	4	0.8	40	-
SEMD9900401E	R0.1	0.4	4	0.8	40	-
SEMD99005005E	R0.05	0.5	4	1	40	-
SEMD9900501E	R0.1	0.5	4	1	40	-
SEMD99006005E	R0.05	0.6	4	1.2	40	-
SEMD9900601E	R0.1	0.6	4	1.2	40	-
SEMD9900602E	R0.2	0.6	4	1.2	40	-
SEMD99007005E	R0.05	0.7	4	1.4	40	-
SEMD9900701E	R0.1	0.7	4	1.4	40	-
SEMD9900702E	R0.2	0.7	4	1.4	40	-
SEMD99008005E	R0.05	0.8	4	1.6	40	-
SEMD9900801E	R0.1	0.8	4	1.6	40	-
SEMD9900802E	R0.2	0.8	4	1.6	40	-
SEMD99009005E	R0.05	0.9	4	1.8	40	-
SEMD9900901E	R0.1	0.9	4	1.8	40	-
SEMD990100054SE	R0.05	1.0	4	2.5	50	4mm Shank
SEMD99010014SE	R0.1	1.0	4	2.5	50	4mm Shank
SEMD99010024SE	R0.2	1.0	4	2.5	50	4mm Shank
SEMD99010034SE	R0.3	1.0	4	2.5	50	4mm Shank
SEMD99010005E	R0.05	1.0	6	2.5	50	-

★ : Stock Item

▶ NEXT PAGE

Size	Corner Radius Tolerance (mm)	Mill Dia. Tolerance (mm)	Shank Dia. Tolerance
up to Ø6	± 0.010	0 ~ - 0.012	h5
over Ø6	± 0.015	0 ~ - 0.015	

◎ : Excellent ○ : Good

ISO Material Description	P										M			K							
	Non-alloy steel					Low alloy steel					High alloyed steel, and tool steel			Stainless steel			Grey cast iron		Nodular cast iron		Malleable cast iron
VDI 3323	1	2	3	4	5	6	7	8	9	10	11	12	13	14	15	16	17	18	19	20	
HRC		13	25	28	32	10	29	32	38	15	35	15	23	10	10	26	3	25	130	21	
HB	125	190	250	270	300	180	275	300	350	200	325	200	240	180	180	260	160	250	130	230	
Recommend	○	○	◎	◎	◎	○	◎	◎	◎	◎	◎	○	○	○	○	○	○	○	○	○	

ISO Material Description	N					S					H										
	Aluminum-wrought alloy		Aluminum-cast, alloyed			Copper and Copper Alloys (Bronze / Brass)			Non Metallic Materials		Heat Resistant Super Alloys			Titanium Alloys		Hardened steel	Chilled Cast Iron	Hardened Cast Iron			
VDI 3323	21	22	23	24	25	26	27	28	29	30	31	32	33	34	35	36	37	38	39	40	41
HRC											15	30	25	38	34			55	60	42	55
HB	60	100	75	90	130	110	90	100			200	280	250	350	320	400 Rm	1050 Rm	550	630	400	550
Recommend																		○	◎	◎	○

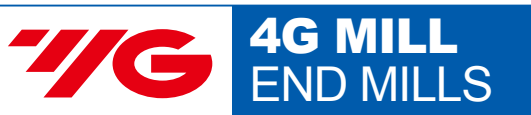

CARBIDE, 2 FLUTE CORNER RADIUS (Short, Regular, Long Shank)

● **VOLLHARTMETALL, 2 SCHNEIDEN ECKENRADIUS**

● **Fraise carbure, 2 dents, torique**

● **MD, 2 TAGLIANTI, TORICA (Serie corta, media e lunga)**

- ▶ New coating and tool geometry applied resulting outstanding cutting abilities and wear resistance.
- ▶ Excellent for cutting prehardened steels, carbon steels, alloy steels of molds and dies, up to HRC55 and machine parts.
- ▶ Available in short, regular and long shank end mills.
- ▶ Available with various corner radius end mills, from 0.02mm to 5.0mm corner radius.

- ▶ Aufgrund einer neuartigen Beschichtung und neuer Werkzeuggeometrien hervorragende Schnittleistung und Verschleißfestigkeit
- ▶ Ausgezeichnet geeignet für das Fräsen von vorvergütetem Stahl, kohlenstoff Stahl, legiertem Stahl für Formen, bis HRC55 und Maschinenbauteile.
- ▶ Erhältlich in den Schaft-Ausführungen: kurz, standard und lang
- ▶ Erhältlich in verschiedenen Eckradien-Ausführungen: von 0,02mm bis zu 5,0mm Eckradius.

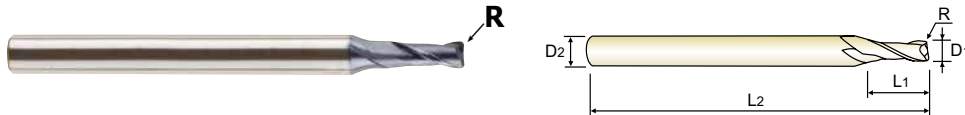

CARBIDE 2 30° ±0.010 ±0.015 PLAIN P.290-291

Ø0.2-Ø6 Ø7-Ø20

Unit : mm

EDP No.	Corner Radius	Mill Diameter	Shank Diameter	Length of Cut	Overall Length	Remark
	R	D1	D2	L1	L2	
SEMD9901001E	R0.1	1.0	6	2.5	50	-
★ SEMD9901002E	R0.2	1.0	6	2.5	50	-
★ SEMD9901003E	R0.3	1.0	6	2.5	50	-
SEMD990120054SE	R0.05	1.2	4	3	50	4mm Shank
SEMD99012014SE	R0.1	1.2	4	3	50	4mm Shank
SEMD99012024SE	R0.2	1.2	4	3	50	4mm Shank
SEMD99012034SE	R0.3	1.2	4	3	50	4mm Shank
SEMD99012005E	R0.05	1.2	6	3	50	-
SEMD9901201E	R0.1	1.2	6	3	50	-
SEMD9901202E	R0.2	1.2	6	3	50	-
SEMD9901203E	R0.3	1.2	6	3	50	-
SEMD990150054SE	R0.05	1.5	4	4	50	-
SEMD99015014SE	R0.1	1.5	4	4	50	4mm Shank
SEMD99015024SE	R0.2	1.5	4	4	50	4mm Shank
SEMD99015034SE	R0.3	1.5	4	4	50	4mm Shank
SEMD99015054SE	R0.5	1.5	4	4	50	4mm Shank
SEMD99015005E	R0.05	1.5	6	4	50	-
SEMD9901501E	R0.1	1.5	6	4	50	-
★ SEMD9901502E	R0.2	1.5	6	4	50	-
★ SEMD9901503E	R0.3	1.5	6	4	50	-
★ SEMD9901505E	R0.5	1.5	6	4	50	-
SEMD99020014SE	R0.1	2.0	4	6	50	4mm Shank
SEMD99020024SE	R0.2	2.0	4	6	50	4mm Shank
SEMD99020034SE	R0.3	2.0	4	6	50	4mm Shank

★ : Stock Item

▶ NEXT PAGE

Size	Corner Radius Tolerance (mm)	Mill Dia. Tolerance (mm)	Shank Dia. Tolerance
up to Ø6	± 0.010	0 ~ - 0.012	h5
over Ø6	± 0.015	0 ~ - 0.015	

◎ : Excellent ○ : Good

ISO Material Description	P										M			K							
	Non-alloy steel					Low alloy steel					High alloyed steel, and tool steel			Stainless steel			Grey cast iron		Nodular cast iron	Malleable cast iron	
VDI 3323	1	2	3	4	5	6	7	8	9	10	11	12	13	14	15	16	17	18	19	20	
HRc																					
HB	125	190	250	270	300	180	275	300	350	200	325	200	240	180	180	260	160	250	130	230	
Recommend	○	○	◎	◎	◎	○	◎	◎	◎	○	◎	○	◎	◎	○	○	○	○	○	○	
ISO Material Description	N										S						H				
	Aluminum-wrought alloy		Aluminum-cast, alloyed			Copper and Copper Alloys (Bronze / Brass)			Non Metallic Materials		Heat Resistant Super Alloys						Titanium Alloys		Hardened steel	Chilled Cast Iron	Hardened Cast Iron
VDI 3323	21	22	23	24	25	26	27	28	29	30	31	32	33	34	35	36	37	38	39	40	41
HRc																					
HB	60	100	75	90	130	110	90	100			200	280	250	350	320	400 Rm	1050 Rm	550	630	400	550
Recommend	○	○	○	○	○	○	○	○	○	○	○	○	○	○	○	○	○	○	○	○	○



4G MILL END MILLS

PLAIN SHANK

SEMD99 SERIES

CARBIDE, 2 FLUTE CORNER RADIUS (Short, Regular, Long Shank)

● VOLLHARTMETALL, 2 SCHNEIDEN ECKENRADIUS

() Fraise carbure, 2 dents, torique

() MD, 2 TAGLIENTI, TORICA (Serie corta, media e lunga)

- ▶ New coating and tool geometry applied resulting outstanding cutting abilities and wear resistance.
- ▶ Excellent for cutting prehardened steels, carbon steels, alloy steels of molds and dies, up to HRC55 and machine parts.
- ▶ Available in short, regular and long shank end mills.
- ▶ Available with various corner radius end mills, from 0.02mm to 5.0mm corner radius.

- ▶ Aufgrund einer neuartigen Beschichtung und neuer Werkzeuggeometrien hervorragende Schnittleistung und Verschleißfestigkeit
- ▶ Ausgezeichnet geeignet für das Fräsen von vorvergütetem Stahl, kohlenstoff Stahl, legiertem Stahl für Formen, bis HRC55 und Maschinenbauteile.
- ▶ Erhältlich in den Schaft-Ausführungen: kurz, standard und lang
- ▶ Erhältlich in verschiedenen Eckradien-Ausführungen: von 0,02mm bis zu 5,0mm Eckradius.

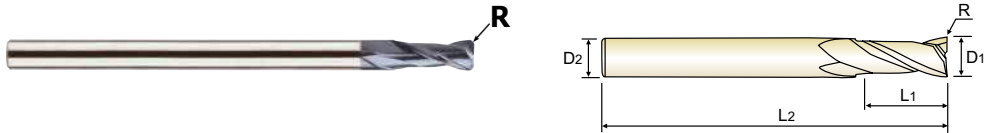

Ø0.2-Ø6 Ø7-Ø20

Unit : mm

EDP No.	Corner Radius	Mill Diameter	Shank Diameter	Length of Cut	Overall Length	Remark
	R	D1	D2	L1	L2	
SEMD99020054SE	R0.5	2.0	4	6	50	4mm Shank
SEMD9902001E	R0.1	2.0	6	6	50	-
★ SEMD9902002E	R0.2	2.0	6	6	50	-
★ SEMD9902003E	R0.3	2.0	6	6	50	-
★ SEMD9902005E	R0.5	2.0	6	6	50	-
SEMD99025014SE	R0.1	2.5	4	7	60	4mm Shank
SEMD99025024SE	R0.2	2.5	4	7	60	4mm Shank
SEMD99025034SE	R0.3	2.5	4	7	60	4mm Shank
SEMD99025054SE	R0.5	2.5	4	7	60	4mm Shank
SEMD9902501E	R0.1	2.5	6	7	60	-
SEMD9902502E	R0.2	2.5	6	7	60	-
SEMD9902503E	R0.3	2.5	6	7	60	-
SEMD9902505E	R0.5	2.5	6	7	60	-
SEMD9903001E	R0.1	3.0	6	8	60	-
★ SEMD9903002E	R0.2	3.0	6	8	60	-
★ SEMD9903003E	R0.3	3.0	6	8	60	-
★ SEMD9903005E	R0.5	3.0	6	8	60	-
SEMD9903010E	R1.0	3.0	6	8	60	-
SEMD9903501E	R0.1	3.5	6	10	70	-
SEMD9903502E	R0.2	3.5	6	10	70	-
SEMD9903503E	R0.3	3.5	6	10	70	-
SEMD9903505E	R0.5	3.5	6	10	70	-
SEMD99040014SE	R0.1	4.0	4	10	70	4mm Shank
SEMD99040024SE	R0.2	4.0	4	10	70	4mm Shank

★ : Stock Item

▶ NEXT PAGE

Size	Corner Radius Tolerance (mm)	Mill Dia. Tolerance (mm)	Shank Dia. Tolerance
up to Ø6	± 0.010	0 ~ - 0.012	h5
over Ø6	± 0.015	0 ~ - 0.015	

◎ : Excellent ○ : Good

ISO Material Description	P										M			K							
	Non-alloy steel					Low alloy steel					High alloyed steel, and tool steel			Stainless steel			Grey cast iron		Nodular cast iron		Malleable cast iron
VDI 3323	1	2	3	4	5	6	7	8	9	10	11	12	13	14	15	16	17	18	19	20	
HRC		13	25	28	32	10	29	32	38	15	35	15	23	10	10	26	3	25	21	21	
HB	125	190	250	270	300	180	275	300	350	200	325	200	240	180	180	260	160	250	130	230	
Recommend	○	○	◎	◎	◎	○	◎	◎	◎	◎	◎	○	○	○	○	○	○	○	○	○	
ISO Material Description	N					S					H										
	Aluminum-wrought alloy		Aluminum-cast, alloyed			Copper and Copper Alloys (Bronze / Brass)			Non Metallic Materials		Heat Resistant Super Alloys			Titanium Alloys		Hardened steel	Chilled Cast Iron	Hardened Cast Iron			
VDI 3323	21	22	23	24	25	26	27	28	29	30	31	32	33	34	35	36	37	38	39	40	41
HRC											15	30	25	38	34			55	60	42	55
HB	60	100	75	90	130	110	90	100			200	280	250	350	320	400 Rm	1050 Rm	550	630	400	550
Recommend																		○	◎	○	○

CARBIDE, 2 FLUTE CORNER RADIUS (Short, Regular, Long Shank)

● **VOLLHARTMETALL, 2 SCHNEIDEN ECKENRADIUS**

● **Fraise carbure, 2 dents, torique**

● **MD, 2 TAGLIANTI, TORICA (Serie corta, media e lunga)**

- ▶ New coating and tool geometry applied resulting outstanding cutting abilities and wear resistance.
- ▶ Excellent for cutting prehardened steels, carbon steels, alloy steels of molds and dies, up to HRC55 and machine parts.
- ▶ Available in short, regular and long shank end mills.
- ▶ Available with various corner radius end mills, from 0.02mm to 5.0mm corner radius.

- ▶ Aufgrund einer neuartigen Beschichtung und neuer Werkzeuggeometrien hervorragende Schnittleistung und Verschleißfestigkeit
- ▶ Ausgezeichnet geeignet für das Fräsen von vorvergütetem Stahl, kohlenstoff Stahl, legiertem Stahl für Formen, bis HRC55 und Maschinenbauteile.
- ▶ Erhältlich in den Schaft-Ausführungen: kurz, standard und lang
- ▶ Erhältlich in verschiedenen Eckradien-Ausführungen: von 0,02mm bis zu 5,0mm Eckradius.

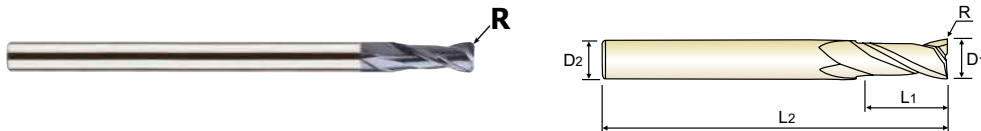

CARBIDE 2 30° ±0.010 ±0.015 PLAIN P.290-291

Ø0.2-Ø6 Ø7-Ø20

Unit : mm

EDP No.	Corner Radius	Mill Diameter	Shank Diameter	Length of Cut	Overall Length	Remark
	R	D1	D2	L1	L2	
SEMD99040034SE	R0.3	4.0	4	10	70	4mm Shank
SEMD99040054SE	R0.5	4.0	4	10	70	4mm Shank
SEMD99040104SE	R1.0	4.0	4	10	70	4mm Shank
SEMD99040011004SE	R0.1	4.0	4	10	100	4mm Shank
SEMD99040021004SE	R0.2	4.0	4	10	100	4mm Shank
SEMD99040031004SE	R0.3	4.0	4	10	100	4mm Shank
SEMD99040051004SE	R0.5	4.0	4	10	100	4mm Shank
SEMD99040101004SE	R1.0	4.0	4	10	100	4mm Shank
SEMD9904001E	R0.1	4.0	6	10	70	Regular
★ SEMD9904002E	R0.2	4.0	6	10	70	Regular
★ SEMD9904003E	R0.3	4.0	6	10	70	Regular
★ SEMD9904005E	R0.5	4.0	6	10	70	Regular
★ SEMD9904010E	R1.0	4.0	6	10	70	Regular
SEMD9904501E	R0.1	4.5	6	11	80	-
SEMD9904502E	R0.2	4.5	6	11	80	-
SEMD9904503E	R0.3	4.5	6	11	80	-
SEMD9904505E	R0.5	4.5	6	11	80	-
SEMD9905001E	R0.1	5.0	6	13	90	-
★ SEMD9905002E	R0.2	5.0	6	13	90	-
★ SEMD9905003E	R0.3	5.0	6	13	90	-
★ SEMD9905005E	R0.5	5.0	6	13	90	-
★ SEMD9905010E	R1.0	5.0	6	13	90	-
SEMD9905501E	R0.1	5.5	6	13	90	-
SEMD9905502E	R0.2	5.5	6	13	90	-

★ : Stock Item

▶ NEXT PAGE

Size	Corner Radius Tolerance (mm)	Mill Dia. Tolerance (mm)	Shank Dia. Tolerance
up to Ø6	± 0.010	0 ~ - 0.012	h5
over Ø6	± 0.015	0 ~ - 0.015	

◎ : Excellent ○ : Good

ISO Material Description	P										M			K							
	Non-alloy steel					Low alloy steel					High alloyed steel, and tool steel			Stainless steel			Grey cast iron	Nodular cast iron		Malleable cast iron	
VDI 3323	1	2	3	4	5	6	7	8	9	10	11	12	13	14	15	16	17	18	19	20	
HRc		13	25	28	32	10	29	32	38	15	35	15	23	10	10	26	3	25		21	
HB	125	190	250	270	300	180	275	300	350	200	325	200	240	180	180	260	160	250	130	230	
Recommend	○	○	◎	◎	◎	○	◎	◎	◎	○	◎	○	○	○	○	○	○	○	○	○	
ISO Material Description	N										S						H				
	Aluminum-wrought alloy		Aluminum-cast, alloyed			Copper and Copper Alloys (Bronze / Brass)			Non Metallic Materials		Heat Resistant Super Alloys						Titanium Alloys		Hardened steel	Chilled Cast Iron	Hardened Cast Iron
VDI 3323	21	22	23	24	25	26	27	28	29	30	31	32	33	34	35	36	37	38	39	40	41
HRc											15	30	25	38	34			55	60	42	55
HB	60	100	75	90	130	110	90	100			200	280	250	350	320	400 Rm	1050 Rm	550	630	400	550
Recommend											○	○	○	○	○	○	○	○	○	◎	○

CARBIDE, 2 FLUTE CORNER RADIUS (Short, Regular, Long Shank)

- **VOLLHARTMETALL, 2 SCHNEIDEN ECKENRADIUS**
- (●) **Fraise carbure, 2 dents, torique**
- (●) **MD, 2 TAGLIENTI, TORICA (Serie corta, media e lunga)**

- ▶ New coating and tool geometry applied resulting outstanding cutting abilities and wear resistance.
- ▶ Excellent for cutting prehardened steels, carbon steels, alloy steels of molds and dies, up to HRC55 and machine parts.
- ▶ Available in short, regular and long shank end mills.
- ▶ Available with various corner radius end mills, from 0.02mm to 5.0mm corner radius.

- ▶ Aufgrund einer neuartigen Beschichtung und neuer Werkzeuggeometrien hervorragende Schnittleistung und Verschleißfestigkeit
- ▶ Ausgezeichnet geeignet für das Fräsen von vorvergütetem Stahl, kohlenstoff Stahl, legiertem Stahl für Formen, bis HRC55 und Maschinenbauteile.
- ▶ Erhältlich in den Schaft-Ausführungen: kurz, standard und lang
- ▶ Erhältlich in verschiedenen Eckradien-Ausführungen: von 0,02mm bis zu 5,0mm Eckradius.

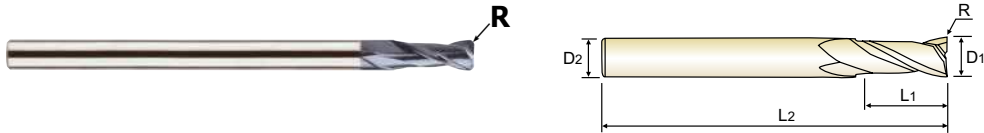

CARBIDE 2 30° ±0.010 ±0.015 PLAIN P.290-291

Ø0.2-Ø6 Ø7-Ø20

Unit : mm

EDP No.	Corner Radius	Mill Diameter	Shank Diameter	Length of Cut	Overall Length	Remark
	R	D1	D2	L1	L2	
SEMD9905503E	R0.3	5.5	6	13	90	-
SEMD9905505E	R0.5	5.5	6	13	90	-
SEMD9905510E	R1.0	5.5	6	13	90	-
★ SEMD9906002060E	R0.2	6.0	6	15	60	Short
★ SEMD9906003060E	R0.3	6.0	6	15	60	Short
★ SEMD9906005060E	R0.5	6.0	6	15	60	Short
★ SEMD9906010060E	R1.0	6.0	6	15	60	Short
SEMD9906001E	R0.1	6.0	6	15	90	Regular
★ SEMD9906002E	R0.2	6.0	6	15	90	Regular
★ SEMD9906003E	R0.3	6.0	6	15	90	Regular
★ SEMD9906005E	R0.5	6.0	6	15	90	Regular
★ SEMD9906010E	R1.0	6.0	6	15	90	Regular
SEMD9906015E	R1.5	6.0	6	15	90	Regular
SEMD9906020E	R2.0	6.0	6	15	90	Regular
SEMD9906005E	R0.5	6.0	6	15	110	Long Shank
SEMD9906010110E	R1.0	6.0	6	15	110	Long Shank
SEMD9906005130E	R0.5	6.0	6	15	130	Long Shank
SEMD9906010130E	R1.0	6.0	6	15	130	Long Shank
SEMD9907001E	R0.1	7.0	8	16	90	-
SEMD9907002E	R0.2	7.0	8	16	90	-
SEMD9907003E	R0.3	7.0	8	16	90	-
SEMD9907005E	R0.5	7.0	8	16	90	-
SEMD9907010E	R1.0	7.0	8	16	90	-
SEMD9907020E	R2.0	7.0	8	16	90	-

★ : Stock Item

▶ NEXT PAGE

Size	Corner Radius Tolerance (mm)	Mill Dia. Tolerance (mm)	Shank Dia. Tolerance
up to Ø6	± 0.010	0 ~ - 0.012	h5
over Ø6	± 0.015	0 ~ - 0.015	

◎ : Excellent ○ : Good

ISO Material Description	P										M				K					
	Non-alloy steel					Low alloy steel					High alloyed steel, and tool steel		Stainless steel		Grey cast iron		Nodular cast iron		Malleable cast iron	
VDI 3323	1	2	3	4	5	6	7	8	9	10	11	12	13	14	15	16	17	18	19	20
HRC		13	25	28	32	10	29	32	38	15	35	15	23	10	10	26	3	25	42	21
HB	125	190	250	270	300	180	275	300	350	200	325	200	240	180	180	260	160	250	130	230
Recommend	○	○	◎	◎	◎	○	◎	◎	◎	◎	◎	○	○	○	○	○	○	○	○	○

ISO Material Description	N					S					H										
	Aluminum-wrought alloy		Aluminum-cast, alloyed		Copper and Copper Alloys (Bronze / Brass)	Non Metallic Materials	Heat Resistant Super Alloys			Titanium Alloys	Hardened steel	Chilled Cast Iron	Hardened Cast Iron								
VDI 3323	21	22	23	24	25	26	27	28	29	30	31	32	33	34	35	36	37	38	39	40	41
HRC											15	30	25	38	34			55	60	42	55
HB	60	100	75	90	130	110	90	100			200	280	250	350	320	400 Rm	1050 Rm	550	630	400	550
Recommend																		○	◎	◎	○

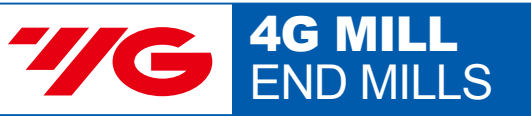

CARBIDE, 2 FLUTE CORNER RADIUS (Short, Regular, Long Shank)

● **VOLLHARTMETALL, 2 SCHNEIDEN ECKENRADIUS**

● **Fraise carbure, 2 dents, torique**

● **MD, 2 TAGLIANTI, TORICA (Serie corta, media e lunga)**

- ▶ New coating and tool geometry applied resulting outstanding cutting abilities and wear resistance.
- ▶ Excellent for cutting prehardened steels, carbon steels, alloy steels of molds and dies, up to HRC55 and machine parts.
- ▶ Available in short, regular and long shank end mills.
- ▶ Available with various corner radius end mills, from 0.02mm to 5.0mm corner radius.

- ▶ Aufgrund einer neuartigen Beschichtung und neuer Werkzeuggeometrien hervorragende Schnittleistung und Verschleißfestigkeit
- ▶ Ausgezeichnet geeignet für das Fräsen von vorvergütetem Stahl, kohlenstoff Stahl, legiertem Stahl für Formen, bis HRC55 und Maschinenbauteile.
- ▶ Erhältlich in den Schaft-Ausführungen: kurz, standard und lang
- ▶ Erhältlich in verschiedenen Eckradien-Ausführungen: von 0,02mm bis zu 5,0mm Eckradius.

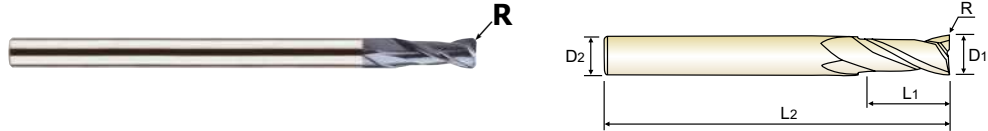

CARBIDE 2 30° ±0.010 ±0.015 PLAIN P.290-291
 Ø0.2-Ø6 Ø7-Ø20

Unit : mm

EDP No.	Corner Radius	Mill Diameter	Shank Diameter	Length of Cut	Overall Length	Remark
	R	D1	D2	L1	L2	
SEMD9908003070E	R0.3	8.0	8	20	70	Short
★ SEMD9908005070E	R0.5	8.0	8	20	70	Short
★ SEMD9908010070E	R1.0	8.0	8	20	70	Short
SEMD9908001E	R0.1	8.0	8	20	100	Regular
SEMD9908002E	R0.2	8.0	8	20	100	Regular
SEMD9908003E	R0.3	8.0	8	20	100	Regular
★ SEMD9908005E	R0.5	8.0	8	20	100	Regular
★ SEMD9908010E	R1.0	8.0	8	20	100	Regular
★ SEMD9908015E	R1.5	8.0	8	20	100	Regular
★ SEMD9908020E	R2.0	8.0	8	20	100	Regular
SEMD9908025E	R2.5	8.0	8	20	100	Regular
SEMD9908030E	R3.0	8.0	8	20	100	Regular
SEMD9908005120E	R0.5	8.0	8	20	120	Long Shank
SEMD9908010120E	R1.0	8.0	8	20	120	Long Shank
SEMD9908015150E	R0.5	8.0	8	20	150	Long Shank
SEMD9908010150E	R1.0	8.0	8	20	150	Long Shank
SEMD9910003075E	R0.3	10.0	10	25	75	Short
★ SEMD9910005075E	R0.5	10.0	10	25	75	Short
★ SEMD9910010075E	R1.0	10.0	10	25	75	Short
SEMD9910001E	R0.1	10.0	10	25	100	Regular
SEMD9910002E	R0.2	10.0	10	25	100	Regular
SEMD9910003E	R0.3	10.0	10	25	100	Regular
★ SEMD9910005E	R0.5	10.0	10	25	100	Regular
★ SEMD9910010E	R1.0	10.0	10	25	100	Regular

★ : Stock Item

▶ NEXT PAGE

Size	Corner Radius Tolerance (mm)	Mill Dia. Tolerance (mm)	Shank Dia. Tolerance
up to Ø6	± 0.010	0 ~ - 0.012	h5
over Ø6	± 0.015	0 ~ - 0.015	

◎ : Excellent ○ : Good

ISO Material Description	P										M			K							
	Non-alloy steel					Low alloy steel					High alloyed steel, and tool steel			Stainless steel			Grey cast iron		Nodular cast iron		Malleable cast iron
VDI 3323	1	2	3	4	5	6	7	8	9	10	11	12	13	14	15	16	17	18	19	20	
HRc		13	25	28	32	10	29	32	38	15	35	15	23	10	10	26	3	25		21	
HB	125	190	250	270	300	180	275	300	350	200	325	200	240	180	180	260	160	250	130	230	
Recommend	○	○	◎	◎	◎	○	◎	◎	◎	○	◎	○	○	○	○	○	○	○	○	○	
ISO Material Description	N										S						H				
	Aluminum-wrought alloy		Aluminum-cast, alloyed			Copper and Copper Alloys (Bronze / Brass)			Non Metallic Materials		Heat Resistant Super Alloys						Titanium Alloys		Hardened steel	Chilled Cast Iron	Hardened Cast Iron
VDI 3323	21	22	23	24	25	26	27	28	29	30	31	32	33	34	35	36	37	38	39	40	41
HRc											15	30	25	38	34			55	60	42	55
HB	60	100	75	90	130	110	90	100			200	280	250	350	320	400 Rm	1050 Rm	550	630	400	550
Recommend											○	○	○	○	○	○	○	○	○	◎	○

CARBIDE, 2 FLUTE CORNER RADIUS (Short, Regular, Long Shank)

- **VOLLHARTMETALL, 2 SCHNEIDEN ECKENRADIUS**
- **Fraise carbure, 2 dents, torique**
- **MD, 2 TAGLIENTI, TORICA (Serie corta, media e lunga)**

- ▶ New coating and tool geometry applied resulting outstanding cutting abilities and wear resistance.
- ▶ Excellent for cutting prehardened steels, carbon steels, alloy steels of molds and dies, up to HRC55 and machine parts.
- ▶ Available in short, regular and long shank end mills.
- ▶ Available with various corner radius end mills, from 0.02mm to 5.0mm corner radius.

- ▶ Aufgrund einer neuartigen Beschichtung und neuer Werkzeuggeometrien hervorragende Schnittleistung und Verschleißfestigkeit
- ▶ Ausgezeichnet geeignet für das Fräsen von vorvergütetem Stahl, kohlenstoff Stahl, legiertem Stahl für Formen, bis HRC55 und Maschinenbauteile.
- ▶ Erhältlich in den Schaft-Ausführungen: kurz, standard und lang
- ▶ Erhältlich in verschiedenen Eckradien-Ausführungen: von 0,02mm bis zu 5,0mm Eckradius.

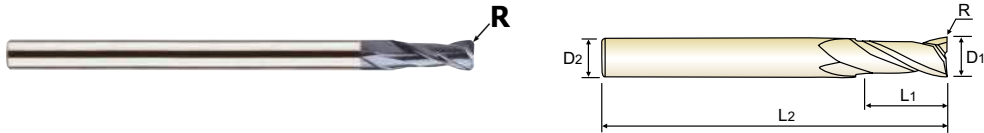

CARBIDE 2 30° ±0.010 ±0.015 PLAIN P.290-291

Ø0.2-Ø6 Ø7-Ø20

Unit : mm

EDP No.	Corner Radius	Mill Diameter	Shank Diameter	Length of Cut	Overall Length	Remark
	R	D1	D2	L1	L2	
★ SEMD9910015E	R1.5	10.0	10	25	100	Regular
★ SEMD9910020E	R2.0	10.0	10	25	100	Regular
SEMD9910025E	R2.5	10.0	10	25	100	Regular
SEMD9910030E	R3.0	10.0	10	25	100	Regular
SEMD9910040E	R4.0	10.0	10	25	100	Regular
SEMD9910005130E	R0.5	10.0	10	25	130	Long Shank
SEMD9910010130E	R1.0	10.0	10	25	130	Long Shank
SEMD9910005150E	R0.5	10.0	10	25	150	Long Shank
SEMD9910010150E	R1.0	10.0	10	25	150	Long Shank
SEMD9911002E	R0.2	11.0	12	25	110	-
SEMD9911003E	R0.3	11.0	12	25	110	-
SEMD9911005E	R0.5	11.0	12	25	110	-
SEMD9911010E	R1.0	11.0	12	25	110	-
SEMD9911020E	R2.0	11.0	12	25	110	-
SEMD9912003080E	R0.3	12.0	12	30	80	Short
★ SEMD9912005080E	R0.5	12.0	12	30	80	Short
★ SEMD9912010080E	R1.0	12.0	12	30	80	Short
SEMD9912001E	R0.1	12.0	12	30	110	Regular
SEMD9912002E	R0.2	12.0	12	30	110	Regular
SEMD9912003E	R0.3	12.0	12	30	110	Regular
★ SEMD9912005E	R0.5	12.0	12	30	110	Regular
★ SEMD9912010E	R1.0	12.0	12	30	110	Regular
★ SEMD9912015E	R1.5	12.0	12	30	110	Regular
★ SEMD9912020E	R2.0	12.0	12	30	110	Regular

★ : Stock Item

▶ NEXT PAGE

Size	Corner Radius Tolerance (mm)	Mill Dia. Tolerance (mm)	Shank Dia. Tolerance
up to Ø6	± 0.010	0 ~ - 0.012	h5
over Ø6	± 0.015	0 ~ - 0.015	

◎ : Excellent ○ : Good

ISO Material Description	P										M			K							
	Non-alloy steel					Low alloy steel					High alloyed steel, and tool steel			Stainless steel			Grey cast iron		Nodular cast iron		Malleable cast iron
VDI 3323	1	2	3	4	5	6	7	8	9	10	11	12	13	14	15	16	17	18	19	20	
HRC		13	25	28	32	10	29	32	38	15	35	15	23	10	10	26	3	25		21	
HB	125	190	250	270	300	180	275	300	350	200	325	200	240	180	180	260	160	250	130	230	
Recommend	○	○	◎	◎	◎	○	◎	◎	◎	◎	◎	◎	◎	◎	○	○	○	○	○	○	
ISO Material Description	N					S					H										
	Aluminum-wrought alloy		Aluminum-cast, alloyed			Copper and Copper Alloys (Bronze / Brass)			Non Metallic Materials		Heat Resistant Super Alloys			Titanium Alloys		Hardened steel	Chilled Cast Iron	Hardened Cast Iron			
VDI 3323	21	22	23	24	25	26	27	28	29	30	31	32	33	34	35	36	37	38	39	40	41
HRC											15	30	25	38	34			55	60	42	55
HB	60	100	75	90	130	110	90	100			200	280	250	350	320	400 Rm	1050 Rm	550	630	400	550
Recommend																		○	◎	◎	○

YG 4G MILL END MILLS

PLAIN SHANK **SEMD99** SERIES

CARBIDE, 2 FLUTE CORNER RADIUS (Short, Regular, Long Shank)

● **VOLLHARTMETALL, 2 SCHNEIDEN ECKENRADIUS**

● **Fraise carbure, 2 dents, torique**

● **MD, 2 TAGLIANTI, TORICA (Serie corta, media e lunga)**

- ▶ New coating and tool geometry applied resulting outstanding cutting abilities and wear resistance.
- ▶ Excellent for cutting prehardened steels, carbon steels, alloy steels of molds and dies, up to HRC55 and machine parts.
- ▶ Available in short, regular and long shank end mills.
- ▶ Available with various corner radius end mills, from 0.02mm to 5.0mm corner radius.

- ▶ Aufgrund einer neuartigen Beschichtung und neuer Werkzeuggeometrien hervorragende Schnittleistung und Verschleißfestigkeit
- ▶ Ausgezeichnet geeignet für das Fräsen von vorvergütetem Stahl, kohlenstoff Stahl, legiertem Stahl für Formen, bis HRC55 und Maschinenbauteile.
- ▶ Erhältlich in den Schaft-Ausführungen: kurz, standard und lang
- ▶ Erhältlich in verschiedenen Eckradien-Ausführungen: von 0,02mm bis zu 5,0mm Eckradius.

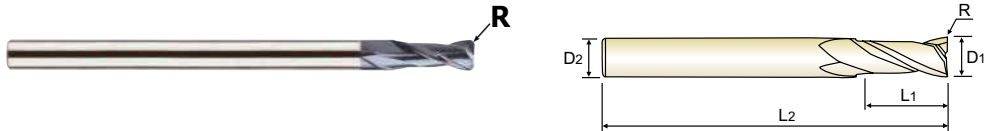

CARBIDE
2
30°
±0.010
±0.015
PLAIN
P.290-291

Ø0.2-Ø6 Ø7-Ø20

Unit : mm

EDP No.	Corner Radius	Mill Diameter	Shank Diameter	Length of Cut	Overall Length	Remark
	R	D1	D2	L1	L2	
★ SEMD9912025E	R2.5	12.0	12	30	110	Regular
★ SEMD9912030E	R3.0	12.0	12	30	110	Regular
SEMD9912040E	R4.0	12.0	12	30	110	Regular
SEMD9912050E	R5.0	12.0	12	30	110	Regular
SEMD9912005130E	R0.5	12.0	12	30	130	Long Shank
SEMD9912010130E	R1.0	12.0	12	30	130	Long Shank
SEMD9912005150E	R0.5	12.0	12	30	150	Long Shank
SEMD9912010150E	R1.0	12.0	12	30	150	Long Shank
SEMD9914005E	R0.5	14.0	16	35	150	-
★ SEMD9914010E	R1.0	14.0	16	35	150	-
SEMD9914020E	R2.0	14.0	16	35	150	-
SEMD9916005E	R0.5	16.0	16	32	150	-
★ SEMD9916010E	R1.0	16.0	16	32	150	-
SEMD9916015E	R1.5	16.0	16	32	150	-
★ SEMD9916020E	R2.0	16.0	16	32	150	-
SEMD9920005E	R0.5	20.0	20	38	150	-
★ SEMD9920010E	R1.0	20.0	20	38	150	-
SEMD9920015E	R1.5	20.0	20	38	150	-
★ SEMD9920020E	R2.0	20.0	20	38	150	-

★ : Stock Item

Size	Corner Radius Tolerance (mm)	Mill Dia. Tolerance (mm)	Shank Dia. Tolerance
up to Ø6	± 0.010	0 ~ - 0.012	h5
over Ø6	± 0.015	0 ~ - 0.015	

◎ : Excellent ○ : Good

ISO Material Description	P										M						K					
	Non-alloy steel					Low alloy steel					High alloyed steel, and tool steel		Stainless steel				Grey cast iron		Nodular cast iron		Malleable cast iron	
VDI 3323	1	2	3	4	5	6	7	8	9	10	11	12	13	14	15	16	17	18	19	20		
HRc		13	25	28	32	10	29	32	38	15	35	15	23	10	10	26	3	25		21		
HB	125	190	250	270	300	180	275	300	350	200	325	200	240	180	180	260	160	250	130	230		
Recommend	○	○	◎	◎	◎	○	◎	◎	◎	○	◎	○	○	○	○	○	○	○	○	○		
ISO Material Description	N										S							H				
	Aluminum-wrought alloy		Aluminum-cast, alloyed			Copper and Copper Alloys (Bronze / Brass)			Non Metallic Materials		Heat Resistant Super Alloys					Titanium Alloys		Hardened steel	Chilled Cast Iron	Hardened Cast Iron		
VDI 3323	21	22	23	24	25	26	27	28	29	30	31	32	33	34	35	36	37	38	39	40	41	
HRc											15	30	25	38	34			55	60	42	55	
HB	60	100	75	90	130	110	90	100			200	280	250	350	320	400 Rm	1050 Rm	550	630	400	550	
Recommend																		◎	◎	◎	○	

CARBIDE, 2 FLUTE CORNER RADIUS with EXTENDED NECK

- **VOLLHARTMETALL, 2 SCHNEIDEN ECKENRADIUS mit ABGESETZTEM SCHAFTTETTEL**
- (●) **Fraise carbure, 2 dents, torique, détalonnée**
- (●) **MD, 2 TAGLIENTI, SCARICATA, TORICA**

- ▶ Due to new coating and new tool geometry, outstanding cutting ability and wear resistance.
- ▶ Excellent for cutting prehardened steels, carbon steels, alloy steels of molds and dies, up to HRC55 and machine parts.
- ▶ Available various products like regular length and long shank end mills etc.
- ▶ Available various corner radius end mills, from min. 0.02mm corner radius to max. 2.0mm corner radius.
- ▶ Available more various effective length and overall length end mills than previous standard products.

- ▶ Aufgrund einer neuartigen Beschichtung und neuer Werkzeuggeometrien hervorragende Schnittleistung und Verschleißfestigkeit
- ▶ Ausgezeichnet geeignet für das Fräsen von vorvergütetem Stahl, kohlenstoff Stahl, legiertem Stahl für Formen, bis HRC55 und Maschinenbauteile.
- ▶ Erhältlich in den Schaft-Ausführungen: standard und lang.
- ▶ Erhältlich in verschiedenen Eckradien-Ausführungen: von 0,02mm bis zu 2,0mm Eckradius.
- ▶ Erhältlich in verschiedenen gesamt Längen und effektiv Längen. Mehr Auswahlmöglichkeiten als bei den bisherigen standard Produkten.

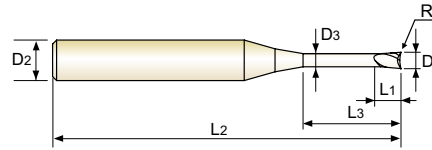

CARBIDE 2 30° ±0.010 ±0.015 PLAIN P.292-299

Ø0.2-Ø6 Ø7-Ø20

Unit : mm

EDP No.	Corner Radius	Mill Diameter	Shank Diameter	Length of Cut	Length Below Shank	Overall Length	Neck Diameter	Remark
	R	D1	D2	L1	L3	L2	D3	
SEME61002002005E	R0.02	0.2	4	0.3	0.5	40	0.17	-
★ SEME6100200201E	R0.02	0.2	4	0.3	1	40	0.17	-
SEME61002002015E	R0.02	0.2	4	0.3	1.5	40	0.17	-
SEME6100200202E	R0.02	0.2	4	0.3	2	40	0.17	-
SEME61002005005E	R0.05	0.2	4	0.3	0.5	40	0.17	-
★ SEME6100200501E	R0.05	0.2	4	0.3	1	40	0.17	-
SEME61002005015E	R0.05	0.2	4	0.3	1.5	40	0.17	-
SEME6100200502E	R0.05	0.2	4	0.3	2	40	0.17	-
SEME61003005015SE	R0.05	0.3	4	0.25	1.5	40	0.27	-
★ SEME6100300201E	R0.02	0.3	4	0.5	1	40	0.27	-
★ SEME6100300202E	R0.02	0.3	4	0.5	2	40	0.27	-
SEME6100300203E	R0.02	0.3	4	0.5	3	40	0.27	-
★ SEME6100300501E	R0.05	0.3	4	0.5	1	40	0.27	-
★ SEME6100300502E	R0.05	0.3	4	0.5	2	40	0.27	-
SEME6100300503E	R0.05	0.3	4	0.5	3	40	0.27	-
SEME6100300502S6SE	R0.05	0.3	6	0.25	2	40	0.27	-
★ SEME6100400501E	R0.05	0.4	4	0.6	1	40	0.37	-
★ SEME61004005015E	R0.05	0.4	4	0.6	1.5	40	0.37	-
★ SEME6100400502E	R0.05	0.4	4	0.6	2	40	0.37	-
★ SEME61004005025E	R0.05	0.4	4	0.6	2.5	40	0.37	-
SEME6100400503E	R0.05	0.4	4	0.6	3	40	0.37	-
SEME6100400504E	R0.05	0.4	4	0.6	4	40	0.37	-
★ SEME610040101E	R0.1	0.4	4	0.6	1	40	0.37	-
SEME6100401015E	R0.1	0.4	4	0.6	1.5	40	0.37	-

★ : Stock Item

▶ NEXT PAGE

Size	Corner Radius Tolerance (mm)	Mill Dia. Tolerance (mm)	Shank Dia. Tolerance
up to Ø6	± 0.010	0 ~ - 0.012	h5
over Ø6	± 0.015	0 ~ - 0.015	

◎ : Excellent ○ : Good

ISO Material Description	P											M			K						
	Non-alloy steel					Low alloy steel						High alloyed steel, and tool steel			Stainless steel			Grey cast iron		Nodular cast iron	
VDI 3323	1	2	3	4	5	6	7	8	9	10	11	12	13	14	15	16	17	18	19	20	
HRC		13	25	28	32	10	29	32	38	15	35	15	23	10	10	26	3	25		21	
HB	125	190	250	270	300	180	275	300	350	200	325	200	240	180	180	260	160	250	130	230	
Recommend	○	○	◎	◎	◎	○	◎	◎	◎	◎	◎	○	○	○	○	○	○	○	○	○	
ISO Material Description	N										S						H				
	Aluminum-wrought alloy		Aluminum-cast, alloyed			Copper and Copper Alloys (Bronze / Brass)			Non Metallic Materials		Heat Resistant Super Alloys						Titanium Alloys		Hardened steel	Chilled Cast Iron	Hardened Cast Iron
VDI 3323	21	22	23	24	25	26	27	28	29	30	31	32	33	34	35	36	37	38	39	40	41
HRC											15	30	25	38	34			55	60	42	55
HB	60	100	75	90	130	110	90	100			200	280	250	350	320	400 Rm	1050 Rm	550	630	400	550
Recommend																		○	◎	○	○

YG 4G MILL END MILLS

PLAIN SHANK

SEME61 SERIES

CARBIDE, 2 FLUTE CORNER RADIUS with EXTENDED NECK

- **VOLLHARTMETALL, 2 SCHNEIDEN ECKENRADIUS mit ABGESETZTEM SCHAFTTETL**
- **Fraise carbure, 2 dents, torique, détalonnée**
- **MD, 2 TAGLIANTI, SCARICATA, TORICA**

- ▶ Due to new coating and new tool geometry, outstanding cutting ability and wear resistance.
- ▶ Excellent for cutting prehardened steels, carbon steels, alloy steels of molds and dies, up to HRC55 and machine parts.
- ▶ Available various products like regular length and long shank end mills etc.
- ▶ Available various corner radius end mills, from min. 0.02mm corner radius to max. 2.0mm corner radius.
- ▶ Available more various effective length and overall length end mills than previous standard products.

- ▶ Aufgrund einer neuartigen Beschichtung und neuer Werkzeuggeometrien hervorragende Schnittleistung und Verschleißfestigkeit
- ▶ Ausgezeichnet geeignet für das Fräsen von vorvergütetem Stahl, kohlenstoff Stahl, legiertem Stahl für Formen, bis HRC55 und Maschinenbauteile.
- ▶ Erhältlich in den Schaft-Ausführungen: standard und lang.
- ▶ Erhältlich in verschiedenen Eckradien-Ausführungen: von 0,02mm bis zu 2,0mm Eckradius.
- ▶ Erhältlich in verschiedenen gesamt Längen und effektiv Längen. Mehr Auswahlmöglichkeiten als bei den bisherigen standard Produkten.

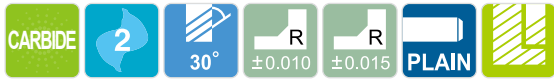
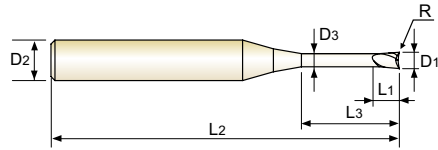

P.292-299

Ø0.2-Ø6 Ø7-Ø20

Unit : mm

EDP No.	Corner Radius	Mill Diameter	Shank Diameter	Length of Cut	Length Below Shank	Overall Length	Neck Diameter	Remark
	R	D1	D2	L1	L3	L2	D3	
★ SEME610040102E	R0.1	0.4	4	0.6	2	40	0.37	-
SEME6100401025E	R0.1	0.4	4	0.6	2.5	40	0.37	-
SEME610040103E	R0.1	0.4	4	0.6	3	40	0.37	-
SEME610040104E	R0.1	0.4	4	0.6	4	40	0.37	-
★ SEME6100500501E	R0.05	0.5	4	0.7	1	45	0.45	-
★ SEME61005005015E	R0.05	0.5	4	0.7	1.5	45	0.45	-
★ SEME6100500502E	R0.05	0.5	4	0.7	2	45	0.45	-
SEME61005005025E	R0.05	0.5	4	0.7	2.5	45	0.45	-
SEME6100500503E	R0.05	0.5	4	0.7	3	45	0.45	-
★ SEME6100500504E	R0.05	0.5	4	0.7	4	45	0.45	-
SEME6100500505E	R0.05	0.5	4	0.7	5	45	0.45	-
SEME6100500506E	R0.05	0.5	4	0.7	6	45	0.45	-
SEME6100500504S6SE	R0.05	0.5	6	0.4	4	45	0.45	-
SEME610050101E	R0.1	0.5	4	0.7	1	45	0.45	-
SEME6100501015E	R0.1	0.5	4	0.7	1.5	45	0.45	-
★ SEME610050102E	R0.1	0.5	4	0.7	2	45	0.45	-
SEME6100501025E	R0.1	0.5	4	0.7	2.5	45	0.45	-
★ SEME610050103E	R0.1	0.5	4	0.7	3	45	0.45	-
SEME610050104E	R0.1	0.5	4	0.7	4	45	0.45	-
★ SEME610050105E	R0.1	0.5	4	0.7	5	45	0.45	-
SEME610050106E	R0.1	0.5	4	0.7	6	45	0.45	-
SEME610050102S6SE	R0.1	0.5	6	0.4	2	45	0.45	-
SEME610050104S6SE	R0.1	0.5	6	0.4	4	45	0.45	-
SEME6100600502E	R0.05	0.6	4	0.9	2	45	0.55	-

★ : Stock Item

▶ NEXT PAGE

Size	Corner Radius Tolerance (mm)	Mill Dia. Tolerance (mm)	Shank Dia. Tolerance
up to Ø6	± 0.010	0 ~ - 0.012	h5
over Ø6	± 0.015	0 ~ - 0.015	

◎ : Excellent ○ : Good

ISO Material Description	P										M			K							
	Non-alloy steel					Low alloy steel					High alloyed steel, and tool steel			Stainless steel			Grey cast iron		Nodular cast iron		Malleable cast iron
VDI 3323	1	2	3	4	5	6	7	8	9	10	11	12	13	14	15	16	17	18	19	20	
HRC		13	25	28	32	10	29	32	38	15	35	15	23	10	10	26	3	25		21	
HB	125	190	250	270	300	180	275	300	350	200	325	200	240	180	180	260	160	250	130	230	
Recommend	○	○	◎	◎	◎	○	◎	◎	◎	○	◎	○	○	○	○	○	○	○	○	○	
ISO Material Description	N										S						H				
	Aluminum-wrought alloy		Aluminum-cast, alloyed			Copper and Copper Alloys (Bronze / Brass)			Non Metallic Materials		Heat Resistant Super Alloys			Titanium Alloys			Hardened steel		Chilled Cast Iron	Hardened Cast Iron	
VDI 3323	21	22	23	24	25	26	27	28	29	30	31	32	33	34	35	36	37	38	39	40	41
HRC											15	30	25	38	34			55	60	42	55
HB	60	100	75	90	130	110	90	100			200	280	250	350	320	400 Rm	1050 Rm	550	630	400	550
Recommend																		◎	◎	◎	○

YG 4G MILL END MILLS

PLAIN SHANK **SEME61** SERIES

CARBIDE, 2 FLUTE CORNER RADIUS with EXTENDED NECK

- VOLLHARTMETALL, 2 SCHNEIDEN ECKENRADIUS mit ABGESETZTEM SCHAFTTETTEL
- () Fraise carbure, 2 dents, torique, détalonnée
- () MD, 2 TAGLIENTI, SCARICATA, TORICA

- ▶ Due to new coating and new tool geometry, outstanding cutting ability and wear resistance.
- ▶ Excellent for cutting prehardened steels, carbon steels, alloy steels of molds and dies, up to HRC55 and machine parts.
- ▶ Available various products like regular length and long shank end mills etc.
- ▶ Available various corner radius end mills, from min. 0.02mm corner radius to max. 2.0mm corner radius.
- ▶ Available more various effective length and overall length end mills than previous standard products.

- ▶ Aufgrund einer neuartigen Beschichtung und neuer Werkzeuggeometrien hervorragende Schnittleistung und Verschleißfestigkeit
- ▶ Ausgezeichnet geeignet für das Fräsen von vorvergütetem Stahl, kohlenstoff Stahl, legiertem Stahl für Formen, bis HRC55 und Maschinenbauteile.
- ▶ Erhältlich in den Schaft-Ausführungen: standard und lang.
- ▶ Erhältlich in verschiedenen Eckradien-Ausführungen: von 0,02mm bis zu 2,0mm Eckradius.
- ▶ Erhältlich in verschiedenen gesamt Längen und effektiv Längen. Mehr Auswahlmöglichkeiten als bei den bisherigen standard Produkten.

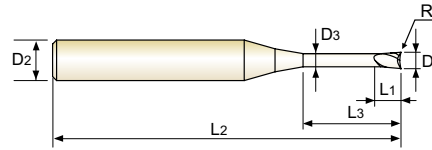

CARBIDE
2
30°
±0.010
±0.015
PLAIN
P.292-299

Ø0.2-Ø6 Ø7-Ø20

Unit : mm

EDP No.	Corner Radius	Mill Diameter	Shank Diameter	Length of Cut	Length Below Shank	Overall Length	Neck Diameter	Remark
	R	D1	D2	L1	L3	L2	D3	
★ SEME6100600503E	R0.05	0.6	4	0.9	3	45	0.55	-
SEME6100600504E	R0.05	0.6	4	0.9	4	45	0.55	-
★ SEME6100600506E	R0.05	0.6	4	0.9	6	45	0.55	-
SEME6100600508E	R0.05	0.6	4	0.9	8	45	0.55	-
SEME6100600510E	R0.05	0.6	4	0.9	10	45	0.55	-
★ SEME610060102E	R0.1	0.6	4	0.9	2	45	0.55	-
★ SEME610060103E	R0.1	0.6	4	0.9	3	45	0.55	-
★ SEME610060104E	R0.1	0.6	4	0.9	4	45	0.55	-
★ SEME610060106E	R0.1	0.6	4	0.9	6	45	0.55	-
SEME610060108E	R0.1	0.6	4	0.9	8	45	0.55	-
SEME610060110E	R0.1	0.6	4	0.9	10	45	0.55	-
★ SEME610060202E	R0.2	0.6	4	0.9	2	45	0.55	-
★ SEME610060203E	R0.2	0.6	4	0.9	3	45	0.55	-
★ SEME610060204E	R0.2	0.6	4	0.9	4	45	0.55	-
★ SEME610060206E	R0.2	0.6	4	0.9	6	45	0.55	-
SEME610060208E	R0.2	0.6	4	0.9	8	45	0.55	-
SEME610060210E	R0.2	0.6	4	0.9	10	45	0.55	-
SEME6100700502E	R0.05	0.7	4	1.2	2	45	0.65	-
SEME6100700504E	R0.05	0.7	4	1.2	4	45	0.65	-
SEME6100700506E	R0.05	0.7	4	1.2	6	45	0.65	-
SEME6100700508E	R0.05	0.7	4	1.2	8	45	0.65	-
SEME6100700510E	R0.05	0.7	4	1.2	10	45	0.65	-
SEME610070102E	R0.1	0.7	4	1.2	2	45	0.65	-
SEME610070104E	R0.1	0.7	4	1.2	4	45	0.65	-

★ : Stock Item

▶ NEXT PAGE

Size	Corner Radius Tolerance (mm)	Mill Dia. Tolerance (mm)	Shank Dia. Tolerance
up to Ø6	± 0.010	0 ~ - 0.012	h5
over Ø6	± 0.015	0 ~ - 0.015	

◎ : Excellent ○ : Good

ISO Material Description	P										M			K						
	Non-alloy steel					Low alloy steel					High alloyed steel, and tool steel			Stainless steel			Grey cast iron	Nodular cast iron		Malleable cast iron
VDI 3323	1	2	3	4	5	6	7	8	9	10	11	12	13	14	15	16	17	18	19	20
HRC		13	25	28	32	10	29	32	38	15	35	15	23	10	10	26	3	25	42	21
HB	125	190	250	270	300	180	275	300	350	200	325	200	240	180	180	260	160	250	130	230
Recommend	○	○	◎	◎	◎	○	◎	◎	◎	◎	◎	○	○	○	○	○	○	○	○	○

ISO Material Description	N									S						H					
	Aluminum-wrought alloy		Aluminum-cast, alloyed			Copper and Copper Alloys (Bronze / Brass)			Non Metallic Materials		Heat Resistant Super Alloys						Titanium Alloys		Hardened steel	Chilled Cast Iron	Hardened Cast Iron
VDI 3323	21	22	23	24	25	26	27	28	29	30	31	32	33	34	35	36	37	38	39	40	41
HRC											15	30	25	38	34			55	60	42	55
HB	60	100	75	90	130	110	90	100			200	280	250	350	320	400 Rm	1050 Rm	550	630	400	550
Recommend																		○	◎	○	○

YG 4G MILL END MILLS

PLAIN SHANK

SEME61 SERIES

CARBIDE, 2 FLUTE CORNER RADIUS with EXTENDED NECK

- **VOLLHARTMETALL, 2 SCHNEIDEN ECKENRADIUS mit ABGESETZTEM SCHAFTTETL**
- **Fraise carbure, 2 dents, torique, détalonnée**
- **MD, 2 TAGLIANTI, SCARICATA, TORICA**

- ▶ Due to new coating and new tool geometry, outstanding cutting ability and wear resistance.
- ▶ Excellent for cutting prehardened steels, carbon steels, alloy steels of molds and dies, up to HRC55 and machine parts.
- ▶ Available various products like regular length and long shank end mills etc.
- ▶ Available various corner radius end mills, from min. 0.02mm corner radius to max. 2.0mm corner radius.
- ▶ Available more various effective length and overall length end mills than previous standard products.

- ▶ Aufgrund einer neuartigen Beschichtung und neuer Werkzeuggeometrien hervorragende Schnittleistung und Verschleißfestigkeit
- ▶ Ausgezeichnet geeignet für das Fräsen von vorvergütetem Stahl, kohlenstoff Stahl, legiertem Stahl für Formen, bis HRC55 und Maschinenbauteile.
- ▶ Erhältlich in den Schaft-Ausführungen: standard und lang.
- ▶ Erhältlich in verschiedenen Eckradien-Ausführungen: von 0,02mm bis zu 2,0mm Eckradius.
- ▶ Erhältlich in verschiedenen gesamt Längen und effektiv Längen. Mehr Auswahlmöglichkeiten als bei den bisherigen standard Produkten.

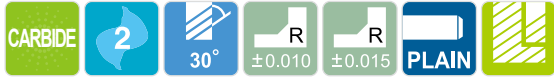
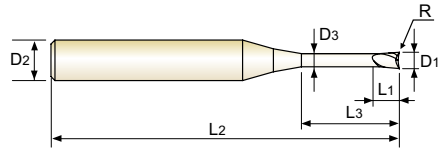

P.292-299

Ø0.2-Ø6 Ø7-Ø20

Unit : mm

EDP No.	Corner Radius	Mill Diameter	Shank Diameter	Length of Cut	Length Below Shank	Overall Length	Neck Diameter	Remark
	R	D1	D2	L1	L3	L2	D3	
SEME610070106E	R0.1	0.7	4	1.2	6	45	0.65	-
SEME610070108E	R0.1	0.7	4	1.2	8	45	0.65	-
SEME610070110E	R0.1	0.7	4	1.2	10	45	0.65	-
SEME610070202E	R0.2	0.7	4	1.2	2	45	0.65	-
SEME610070204E	R0.2	0.7	4	1.2	4	45	0.65	-
SEME610070206E	R0.2	0.7	4	1.2	6	45	0.65	-
SEME610070208E	R0.2	0.7	4	1.2	8	45	0.65	-
SEME610070210E	R0.2	0.7	4	1.2	10	45	0.65	-
★ SEME6100800502E	R0.05	0.8	4	1.2	2	45	0.75	-
SEME6100800503E	R0.05	0.8	4	1.2	3	45	0.75	-
★ SEME6100800504E	R0.05	0.8	4	1.2	4	45	0.75	-
★ SEME6100800506E	R0.05	0.8	4	1.2	6	45	0.75	-
SEME6100800508E	R0.05	0.8	4	1.2	8	45	0.75	-
SEME6100800510E	R0.05	0.8	4	1.2	10	45	0.75	-
★ SEME610080102E	R0.1	0.8	4	1.2	2	45	0.75	-
★ SEME610080103E	R0.1	0.8	4	1.2	3	45	0.75	-
★ SEME610080104E	R0.1	0.8	4	1.2	4	45	0.75	-
★ SEME610080106E	R0.1	0.8	4	1.2	6	45	0.75	-
★ SEME610080108E	R0.1	0.8	4	1.2	8	45	0.75	-
SEME610080110E	R0.1	0.8	4	1.2	10	45	0.75	-
★ SEME610080202E	R0.2	0.8	4	1.2	2	45	0.75	-
★ SEME610080203E	R0.2	0.8	4	1.2	3	45	0.75	-
★ SEME610080204E	R0.2	0.8	4	1.2	4	45	0.75	-
★ SEME610080206E	R0.2	0.8	4	1.2	6	45	0.75	-

★ : Stock Item

▶ NEXT PAGE

Size	Corner Radius Tolerance (mm)	Mill Dia. Tolerance (mm)	Shank Dia. Tolerance
up to Ø6	± 0.010	0 ~ - 0.012	h5
over Ø6	± 0.015	0 ~ - 0.015	

◎ : Excellent ○ : Good

ISO Material Description	P											M			K						
	Non-alloy steel					Low alloy steel				High alloyed steel, and tool steel		Stainless steel			Grey cast iron		Nodular cast iron		Malleable cast iron		
VDI 3323	1	2	3	4	5	6	7	8	9	10	11	12	13	14	15	16	17	18	19	20	
HRC		13	25	28	32	10	29	32	38	15	35	15	23	10	10	26	3	25		21	
HB	125	190	250	270	300	180	275	300	350	200	325	200	240	180	180	260	160	250	130	230	
Recommend	○	○	◎	◎	◎	○	◎	◎	◎	○	◎	○	○	○	○	○	○	○	○	○	
ISO Material Description	N										S						H				
	Aluminum-wrought alloy		Aluminum-cast, alloyed			Copper and Copper Alloys (Bronze / Brass)			Non Metallic Materials		Heat Resistant Super Alloys				Titanium Alloys		Hardened steel	Chilled Cast Iron	Hardened Cast Iron		
VDI 3323	21	22	23	24	25	26	27	28	29	30	31	32	33	34	35	36	37	38	39	40	41
HRC											15	30	25	38	34			55	60	42	55
HB	60	100	75	90	130	110	90	100			200	280	250	350	320	400 Rm	1050 Rm	550	630	400	550
Recommend																		◎	◎	◎	○

CARBIDE, 2 FLUTE CORNER RADIUS with EXTENDED NECK

- **VOLLHARTMETALL, 2 SCHNEIDEN ECKENRADIUS mit ABGESETZTEM SCHAFTTETEL**
- () **Fraise carbure, 2 dents, torique, détalonnée**
- () **MD, 2 TAGLIENTI, SCARICATA, TORICA**

- ▶ Due to new coating and new tool geometry, outstanding cutting ability and wear resistance.
- ▶ Excellent for cutting prehardened steels, carbon steels, alloy steels of molds and dies, up to HRC55 and machine parts.
- ▶ Available various products like regular length and long shank end mills etc.
- ▶ Available various corner radius end mills, from min. 0.02mm corner radius to max. 2.0mm corner radius.
- ▶ Available more various effective length and overall length end mills than previous standard products.

- ▶ Aufgrund einer neuartigen Beschichtung und neuer Werkzeuggeometrien hervorragende Schnittleistung und Verschleißfestigkeit
- ▶ Ausgezeichnet geeignet für das Fräsen von vorvergütetem Stahl, kohlenstoff Stahl, legiertem Stahl für Formen, bis HRC55 und Maschinenbauteile.
- ▶ Erhältlich in den Schaft-Ausführungen: standard und lang.
- ▶ Erhältlich in verschiedenen Eckradien-Ausführungen: von 0,02mm bis zu 2,0mm Eckradius.
- ▶ Erhältlich in verschiedenen gesamt Längen und effektiv Längen. Mehr Auswahlmöglichkeiten als bei den bisherigen standard Produkten.

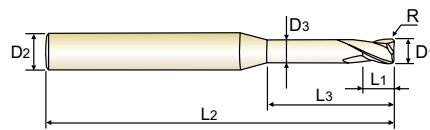

CARBIDE 2 30° ±0.010 ±0.015 PLAIN P.292-299

Ø0.2-Ø6 Ø7-Ø20

Unit : mm

EDP No.	Corner Radius	Mill Diameter	Shank Diameter	Length of Cut	Length Below Shank	Overall Length	Neck Diameter	Remark
	R	D1	D2	L1	L3	L2	D3	
★ SEME610080208E	R0.2	0.8	4	1.2	8	45	0.75	-
★ SEME610080210E	R0.2	0.8	4	1.2	10	45	0.75	-
★ SEME6101000503E	R0.05	1.0	4	1.5	3	50	0.95	-
★ SEME6101000504E	R0.05	1.0	4	1.5	4	50	0.95	-
SEME6101000505E	R0.05	1.0	4	1.5	5	50	0.95	-
★ SEME6101000506E	R0.05	1.0	4	1.5	6	50	0.95	-
SEME6101000508E	R0.05	1.0	4	1.5	8	50	0.95	-
SEME6101000510E	R0.05	1.0	4	1.5	10	50	0.95	-
SEME6101000512E	R0.05	1.0	4	1.5	12	50	0.95	-
SEME6101000514E	R0.05	1.0	4	1.5	14	50	0.95	-
SEME6101000516E	R0.05	1.0	4	1.5	16	50	0.95	-
SEME6101000520E	R0.05	1.0	4	1.5	20	50	0.95	-
★ SEME610100103E	R0.1	1.0	4	1.5	3	50	0.95	-
★ SEME610100104E	R0.1	1.0	4	1.5	4	50	0.95	-
SEME610100105E	R0.1	1.0	4	1.5	5	50	0.95	-
★ SEME610100106E	R0.1	1.0	4	1.5	6	50	0.95	-
★ SEME610100108E	R0.1	1.0	4	1.5	8	50	0.95	-
★ SEME610100110E	R0.1	1.0	4	1.5	10	50	0.95	-
SEME610100112E	R0.1	1.0	4	1.5	12	50	0.95	-
SEME610100114E	R0.1	1.0	4	1.5	14	50	0.95	-
SEME610100116E	R0.1	1.0	4	1.5	16	50	0.95	-
SEME610100120E	R0.1	1.0	4	1.5	20	50	0.95	-
★ SEME610100203E	R0.2	1.0	4	1.5	3	50	0.95	-
★ SEME610100204E	R0.2	1.0	4	1.5	4	50	0.95	-

★ : Stock Item

▶ NEXT PAGE

Size	Corner Radius Tolerance (mm)	Mill Dia. Tolerance (mm)	Shank Dia. Tolerance
up to Ø6	± 0.010	0 ~ - 0.012	h5
over Ø6	± 0.015	0 ~ - 0.015	

◎ : Excellent ○ : Good

ISO Material Description	P										M			K						
	Non-alloy steel					Low alloy steel					High alloyed steel, and tool steel			Stainless steel			Grey cast iron		Nodular cast iron	
VDI 3323	1	2	3	4	5	6	7	8	9	10	11	12	13	14	15	16	17	18	19	20
HRC	13	25	28	32	10	29	32	38	15	35	15	23	10	10	26	3	25	42	21	
HB	125	190	250	270	300	180	275	300	350	200	325	200	240	180	180	260	160	250	130	230
Recommend	○	○	◎	◎	◎	○	◎	◎	◎	◎	◎	○	○	○	○	○	○	○	○	○

ISO Material Description	N									S						H					
	Aluminum-wrought alloy		Aluminum-cast, alloyed			Copper and Copper Alloys (Bronze / Brass)			Non Metallic Materials		Heat Resistant Super Alloys						Titanium Alloys		Hardened steel	Chilled Cast Iron	Hardened Cast Iron
VDI 3323	21	22	23	24	25	26	27	28	29	30	31	32	33	34	35	36	37	38	39	40	41
HRC	15	30	25	38	34	15	30	25	38	34	15	30	25	38	34	55	60	55	60	42	55
HB	60	100	75	90	130	110	90	100			200	280	250	350	320	400 Rm	1050 Rm	550	630	400	550
Recommend																		○	◎	◎	○

CARBIDE, 2 FLUTE CORNER RADIUS with EXTENDED NECK

- **VOLLHARTMETALL, 2 SCHNEIDEN ECKENRADIUS mit ABGESETZTEM SCHAFTTETL**
- **Fraise carbure, 2 dents, torique, détalonnée**
- **MD, 2 TAGLIANTI, SCARICATA, TORICA**

- ▶ Due to new coating and new tool geometry, outstanding cutting ability and wear resistance.
- ▶ Excellent for cutting prehardened steels, carbon steels, alloy steels of molds and dies, up to HRC55 and machine parts.
- ▶ Available various products like regular length and long shank end mills etc.
- ▶ Available various corner radius end mills, from min. 0.02mm corner radius to max. 2.0mm corner radius.
- ▶ Available more various effective length and overall length end mills than previous standard products.

- ▶ Aufgrund einer neuartigen Beschichtung und neuer Werkzeuggeometrien hervorragende Schnittleistung und Verschleißfestigkeit
- ▶ Ausgezeichnet geeignet für das Fräsen von vorvergütetem Stahl, kohlenstoff Stahl, legiertem Stahl für Formen, bis HRC55 und Maschinenbauteile.
- ▶ Erhältlich in den Schaft-Ausführungen: standard und lang.
- ▶ Erhältlich in verschiedenen Eckradien-Ausführungen: von 0,02mm bis zu 2,0mm Eckradius.
- ▶ Erhältlich in verschiedenen gesamt Längen und effektiv Längen. Mehr Auswahlmöglichkeiten als bei den bisherigen standard Produkten.

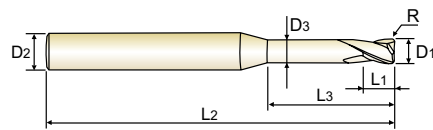

CARBIDE 2 30° ±0.010 ±0.015 PLAIN P.292-299

Ø0.2-Ø6 Ø7-Ø20

Unit : mm

EDP No.	Corner Radius	Mill Diameter	Shank Diameter	Length of Cut	Length Below Shank	Overall Length	Neck Diameter	Remark
	R	D1	D2	L1	L3	L2	D3	
SEME610100205E	R0.2	1.0	4	1.5	5	50	0.95	
★ SEME610100206E	R0.2	1.0	4	1.5	6	50	0.95	-
★ SEME610100208E	R0.2	1.0	4	1.5	8	50	0.95	-
★ SEME610100210E	R0.2	1.0	4	1.5	10	50	0.95	-
★ SEME610100212E	R0.2	1.0	4	1.5	12	50	0.95	-
SEME610100214E	R0.2	1.0	4	1.5	14	50	0.95	-
SEME610100216E	R0.2	1.0	4	1.5	16	50	0.95	-
SEME610100220E	R0.2	1.0	4	1.5	20	50	0.95	-
SEME610100303E	R0.3	1.0	4	1.5	3	50	0.95	-
★ SEME610100304E	R0.3	1.0	4	1.5	4	50	0.95	-
★ SEME610100306E	R0.3	1.0	4	1.5	6	50	0.95	-
★ SEME610100308E	R0.3	1.0	4	1.5	8	50	0.95	-
★ SEME610100310E	R0.3	1.0	4	1.5	10	50	0.95	-
★ SEME610100312E	R0.3	1.0	4	1.5	12	50	0.95	-
SEME610100314E	R0.3	1.0	4	1.5	14	50	0.95	-
SEME610100316E	R0.3	1.0	4	1.5	16	50	0.95	-
SEME610100320E	R0.3	1.0	4	1.5	20	50	0.95	-
SEME6101200503E	R0.05	1.2	4	1.8	3	50	1.15	-
SEME6101200504E	R0.05	1.2	4	1.8	4	50	1.15	-
★ SEME6101200506E	R0.05	1.2	4	1.8	6	50	1.15	-
★ SEME6101200508E	R0.05	1.2	4	1.8	8	50	1.15	-
★ SEME6101200510E	R0.05	1.2	4	1.8	10	50	1.15	-
SEME6101200512E	R0.05	1.2	4	1.8	12	50	1.15	-
SEME6101200516E	R0.05	1.2	4	1.8	16	50	1.15	-

★ : Stock Item

▶ NEXT PAGE

Size	Corner Radius Tolerance (mm)	Mill Dia. Tolerance (mm)	Shank Dia. Tolerance
up to Ø6	± 0.010	0 ~ - 0.012	h5
over Ø6	± 0.015	0 ~ - 0.015	

◎ : Excellent ○ : Good

ISO Material Description	P											M			K						
	Non-alloy steel					Low alloy steel				High alloyed steel, and tool steel		Stainless steel			Grey cast iron		Nodular cast iron		Malleable cast iron		
VDI 3323	1	2	3	4	5	6	7	8	9	10	11	12	13	14	15	16	17	18	19	20	
HRC		13	25	28	32	10	29	32	38	15	35	15	23	10	10	26	3	25		21	
HB	125	190	250	270	300	180	275	300	350	200	325	200	240	180	180	260	160	250	130	230	
Recommend	○	○	◎	◎	◎	○	◎	◎	◎	○	◎	○	○	○	○	○	○	○	○	○	
ISO Material Description	N										S					H					
	Aluminum-wrought alloy		Aluminum-cast, alloyed			Copper and Copper Alloys (Bronze / Brass)			Non Metallic Materials		Heat Resistant Super Alloys					Titanium Alloys		Hardened steel	Chilled Cast Iron	Hardened Cast Iron	
VDI 3323	21	22	23	24	25	26	27	28	29	30	31	32	33	34	35	36	37	38	39	40	41
HRC											15	30	25	38	34			55	60	42	55
HB	60	100	75	90	130	110	90	100			200	280	250	350	320	400 Rm	1050 Rm	550	630	400	550
Recommend																		◎	◎	◎	○

YG 4G MILL END MILLS

PLAIN SHANK **SEME61** SERIES

CARBIDE, 2 FLUTE CORNER RADIUS with EXTENDED NECK

- VOLLHARTMETALL, 2 SCHNEIDEN ECKENRADIUS mit ABGESETZTEM SCHAFTTETEL
- () Fraise carbure, 2 dents, torique, détalonnée
- () MD, 2 TAGLIENTI, SCARICATA, TORICA

- ▶ Due to new coating and new tool geometry, outstanding cutting ability and wear resistance.
- ▶ Excellent for cutting prehardened steels, carbon steels, alloy steels of molds and dies, up to HRC55 and machine parts.
- ▶ Available various products like regular length and long shank end mills etc.
- ▶ Available various corner radius end mills, from min. 0.02mm corner radius to max. 2.0mm corner radius.
- ▶ Available more various effective length and overall length end mills than previous standard products.

- ▶ Aufgrund einer neuartigen Beschichtung und neuer Werkzeuggeometrien hervorragende Schnittleistung und Verschleißfestigkeit
- ▶ Ausgezeichnet geeignet für das Fräsen von vorvergütetem Stahl, kohlenstoff Stahl, legiertem Stahl für Formen, bis HRC55 und Maschinenbauteile.
- ▶ Erhältlich in den Schaft-Ausführungen: standard und lang.
- ▶ Erhältlich in verschiedenen Eckradien-Ausführungen: von 0,02mm bis zu 2,0mm Eckradius.
- ▶ Erhältlich in verschiedenen gesamt Längen und effektiv Längen. Mehr Auswahlmöglichkeiten als bei den bisherigen standard Produkten.

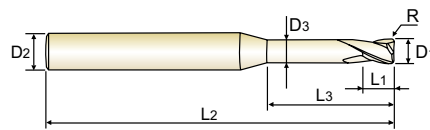

CARBIDE 2 30° ±0.010 ±0.015 PLAIN P.292-299

Ø0.2-Ø6 Ø7-Ø20

Unit : mm

EDP No.	Corner Radius	Mill Diameter	Shank Diameter	Length of Cut	Length Below Shank	Overall Length	Neck Diameter	Remark
	R	D1	D2	L1	L3	L2	D3	
SEME6101200520E	R0.05	1.2	4	1.8	20	50	1.15	-
SEME610120103E	R0.1	1.2	4	1.8	3	50	1.15	-
★ SEME610120104E	R0.1	1.2	4	1.8	4	50	1.15	-
★ SEME610120106E	R0.1	1.2	4	1.8	6	50	1.15	-
★ SEME610120108E	R0.1	1.2	4	1.8	8	50	1.15	-
SEME610120110E	R0.1	1.2	4	1.8	10	50	1.15	-
SEME610120112E	R0.1	1.2	4	1.8	12	50	1.15	-
SEME610120116E	R0.1	1.2	4	1.8	16	50	1.15	-
SEME610120120E	R0.1	1.2	4	1.8	20	50	1.15	-
SEME610120203E	R0.2	1.2	4	1.8	3	50	1.15	-
★ SEME610120204E	R0.2	1.2	4	1.8	4	50	1.15	-
★ SEME610120206E	R0.2	1.2	4	1.8	6	50	1.15	-
★ SEME610120208E	R0.2	1.2	4	1.8	8	50	1.15	-
★ SEME610120210E	R0.2	1.2	4	1.8	10	50	1.15	-
★ SEME610120212E	R0.2	1.2	4	1.8	12	50	1.15	-
SEME610120216E	R0.2	1.2	4	1.8	16	50	1.15	-
SEME610120220E	R0.2	1.2	4	1.8	20	50	1.15	-
SEME610120303E	R0.3	1.2	4	1.8	3	50	1.15	-
★ SEME610120304E	R0.3	1.2	4	1.8	4	50	1.15	-
★ SEME610120306E	R0.3	1.2	4	1.8	6	50	1.15	-
★ SEME610120308E	R0.3	1.2	4	1.8	8	50	1.15	-
★ SEME610120310E	R0.3	1.2	4	1.8	10	50	1.15	-
SEME610120312E	R0.3	1.2	4	1.8	12	50	1.15	-
SEME610120316E	R0.3	1.2	4	1.8	16	50	1.15	-

★ : Stock Item

▶ NEXT PAGE

Size	Corner Radius Tolerance (mm)	Mill Dia. Tolerance (mm)	Shank Dia. Tolerance
up to Ø6	± 0.010	0 ~ - 0.012	h5
over Ø6	± 0.015	0 ~ - 0.015	

◎ : Excellent ○ : Good

ISO Material Description	P											M			K						
	Non-alloy steel					Low alloy steel						High alloyed steel, and tool steel			Stainless steel			Grey cast iron		Nodular cast iron	
VDI 3323	1	2	3	4	5	6	7	8	9	10	11	12	13	14	15	16	17	18	19	20	
HRC		13	25	28	32	10	29	32	38	15	35	15	23	10	10	26	3	25		21	
HB	125	190	250	270	300	180	275	300	350	200	325	200	240	180	180	260	160	250	130	230	
Recommend	○	○	◎	◎	◎	○	◎	◎	◎	◎	◎	○	○	○	○	○	○	○	○	○	
ISO Material Description	N									S						H					
	Aluminum-wrought alloy		Aluminum-cast, alloyed			Copper and Copper Alloys (Bronze / Brass)				Non Metallic Materials		Heat Resistant Super Alloys						Titanium Alloys		Hardened steel	Chilled Cast Iron
VDI 3323	21	22	23	24	25	26	27	28	29	30	31	32	33	34	35	36	37	38	39	40	41
HRC											15	30	25	38	34			55	60	42	55
HB	60	100	75	90	130	110	90	100			200	280	250	350	320	400 Rm	1050 Rm	550	630	400	550
Recommend																		○	◎	○	○

YG 4G MILL END MILLS

PLAIN SHANK

SEME61 SERIES

CARBIDE, 2 FLUTE CORNER RADIUS with EXTENDED NECK

- **VOLLHARTMETALL, 2 SCHNEIDEN ECKENRADIUS mit ABGESETZTEM SCHAFTTETL**
- **Fraise carbure, 2 dents, torique, détalonnée**
- **MD, 2 TAGLIANTI, SCARICATA, TORICA**

- ▶ Due to new coating and new tool geometry, outstanding cutting ability and wear resistance.
- ▶ Excellent for cutting prehardened steels, carbon steels, alloy steels of molds and dies, up to HRC55 and machine parts.
- ▶ Available various products like regular length and long shank end mills etc.
- ▶ Available various corner radius end mills, from min. 0.02mm corner radius to max. 2.0mm corner radius.
- ▶ Available more various effective length and overall length end mills than previous standard products.

- ▶ Aufgrund einer neuartigen Beschichtung und neuer Werkzeuggeometrien hervorragende Schnittleistung und Verschleißfestigkeit
- ▶ Ausgezeichnet geeignet für das Fräsen von vorvergütetem Stahl, kohlenstoff Stahl, legiertem Stahl für Formen, bis HRC55 und Maschinenbauteile.
- ▶ Erhältlich in den Schaft-Ausführungen: standard und lang.
- ▶ Erhältlich in verschiedenen Eckradien-Ausführungen: von 0,02mm bis zu 2,0mm Eckradius.
- ▶ Erhältlich in verschiedenen gesamt Längen und effektiv Längen. Mehr Auswahlmöglichkeiten als bei den bisherigen standard Produkten.

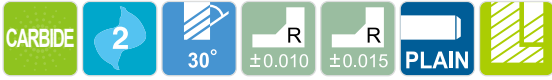
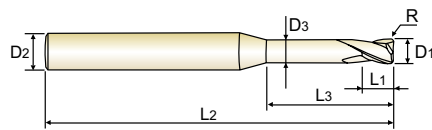

P.292-299

Ø0.2-Ø6 Ø7-Ø20

Unit : mm

EDP No.	Corner Radius	Mill Diameter	Shank Diameter	Length of Cut	Length Below Shank	Overall Length	Neck Diameter	Remark
	R	D1	D2	L1	L3	L2	D3	
SEME610120320E	R0.3	1.2	4	1.8	20	50	1.15	-
★ SEME6101500504E	R0.05	1.5	4	2.3	4	50	1.45	-
★ SEME6101500506E	R0.05	1.5	4	2.3	6	50	1.45	-
★ SEME6101500508E	R0.05	1.5	4	2.3	8	50	1.45	-
SEME6101500510E	R0.05	1.5	4	2.3	10	50	1.45	-
SEME6101500512E	R0.05	1.5	4	2.3	12	50	1.45	-
SEME6101500514E	R0.05	1.5	4	2.3	14	50	1.45	-
SEME6101500516E	R0.05	1.5	4	2.3	16	50	1.45	-
SEME6101500520E	R0.05	1.5	4	2.3	20	50	1.45	-
SEME6101500522E	R0.05	1.5	4	2.3	22	60	1.45	-
SEME6101500526E	R0.05	1.5	4	2.3	26	60	1.45	-
★ SEME610150104E	R0.1	1.5	4	2.3	4	50	1.45	-
★ SEME610150106E	R0.1	1.5	4	2.3	6	50	1.45	-
★ SEME610150108E	R0.1	1.5	4	2.3	8	50	1.45	-
★ SEME610150110E	R0.1	1.5	4	2.3	10	50	1.45	-
★ SEME610150112E	R0.1	1.5	4	2.3	12	50	1.45	-
SEME610150114E	R0.1	1.5	4	2.3	14	50	1.45	-
SEME610150116E	R0.1	1.5	4	2.3	16	50	1.45	-
SEME610150120E	R0.1	1.5	4	2.3	20	50	1.45	-
SEME610150122E	R0.1	1.5	4	2.3	22	60	1.45	-
SEME610150126E	R0.1	1.5	4	2.3	26	60	1.45	-
★ SEME610150204E	R0.2	1.5	4	2.3	4	50	1.45	-
★ SEME610150206E	R0.2	1.5	4	2.3	6	50	1.45	-
★ SEME610150208E	R0.2	1.5	4	2.3	8	50	1.45	-

★ : Stock Item

▶ NEXT PAGE

Size	Corner Radius Tolerance (mm)	Mill Dia. Tolerance (mm)	Shank Dia. Tolerance
up to Ø6	± 0.010	0 ~ - 0.012	h5
over Ø6	± 0.015	0 ~ - 0.015	

◎ : Excellent ○ : Good

ISO Material Description	P											M			K						
	Non-alloy steel					Low alloy steel				High alloyed steel, and tool steel		Stainless steel			Grey cast iron		Nodular cast iron		Malleable cast iron		
VDI 3323	1	2	3	4	5	6	7	8	9	10	11	12	13	14	15	16	17	18	19	20	
HRc		13	25	28	32	10	29	32	38	15	35	15	23	10	10	26	3	25		21	
HB	125	190	250	270	300	180	275	300	350	200	325	200	240	180	180	260	160	250	130	230	
Recommend	○	○	◎	◎	◎	○	◎	◎	◎	○	◎	○	○	○	○	○	○	○	○	○	
ISO Material Description	N										S						H				
	Aluminum-wrought alloy		Aluminum-cast, alloyed			Copper and Copper Alloys (Bronze / Brass)			Non Metallic Materials		Heat Resistant Super Alloys				Titanium Alloys		Hardened steel	Chilled Cast Iron	Hardened Cast Iron		
VDI 3323	21	22	23	24	25	26	27	28	29	30	31	32	33	34	35	36	37	38	39	40	41
HRc											15	30	25	38	34			55	60	42	55
HB	60	100	75	90	130	110	90	100			200	280	250	350	320	400 Rm	1050 Rm	550	630	400	550
Recommend																		◎	◎	◎	○

YG 4G MILL END MILLS

PLAIN SHANK **SEME61** SERIES

CARBIDE, 2 FLUTE CORNER RADIUS with EXTENDED NECK

- VOLLHARTMETALL, 2 SCHNEIDEN ECKENRADIUS mit ABGESETZTEM SCHAFTTETEL
- () Fraise carbure, 2 dents, torique, détalonnée
- () MD, 2 TAGLIENTI, SCARICATA, TORICA

- ▶ Due to new coating and new tool geometry, outstanding cutting ability and wear resistance.
- ▶ Excellent for cutting prehardened steels, carbon steels, alloy steels of molds and dies, up to HRC55 and machine parts.
- ▶ Available various products like regular length and long shank end mills etc.
- ▶ Available various corner radius end mills, from min. 0.02mm corner radius to max. 2.0mm corner radius.
- ▶ Available more various effective length and overall length end mills than previous standard products.

- ▶ Aufgrund einer neuartigen Beschichtung und neuer Werkzeuggeometrien hervorragende Schnittleistung und Verschleißfestigkeit
- ▶ Ausgezeichnet geeignet für das Fräsen von vorvergütetem Stahl, kohlenstoff Stahl, legiertem Stahl für Formen, bis HRC55 und Maschinenbauteile.
- ▶ Erhältlich in den Schaft-Ausführungen: standard und lang.
- ▶ Erhältlich in verschiedenen Eckradien-Ausführungen: von 0,02mm bis zu 2,0mm Eckradius.
- ▶ Erhältlich in verschiedenen gesamt Längen und effektiv Längen. Mehr Auswahlmöglichkeiten als bei den bisherigen standard Produkten.

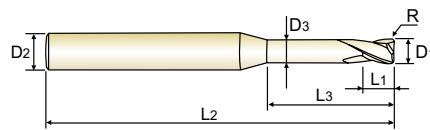

CARBIDE
2
30°
±0.010
±0.015
PLAIN
P.292-299

Ø0.2-Ø6 Ø7-Ø20

Unit : mm

EDP No.	Corner Radius	Mill Diameter	Shank Diameter	Length of Cut	Length Below Shank	Overall Length	Neck Diameter	Remark
	R	D1	D2	L1	L3	L2	D3	
★ SEME610150210E	R0.2	1.5	4	2.3	10	50	1.45	-
★ SEME610150212E	R0.2	1.5	4	2.3	12	50	1.45	-
★ SEME610150214E	R0.2	1.5	4	2.3	14	50	1.45	-
★ SEME610150216E	R0.2	1.5	4	2.3	16	50	1.45	-
★ SEME610150220E	R0.2	1.5	4	2.3	20	50	1.45	-
SEME610150222E	R0.2	1.5	4	2.3	22	60	1.45	-
SEME610150226E	R0.2	1.5	4	2.3	26	60	1.45	-
★ SEME610150304E	R0.3	1.5	4	2.3	4	50	1.45	-
★ SEME610150306E	R0.3	1.5	4	2.3	6	50	1.45	-
★ SEME610150308E	R0.3	1.5	4	2.3	8	50	1.45	-
★ SEME610150310E	R0.3	1.5	4	2.3	10	50	1.45	-
★ SEME610150312E	R0.3	1.5	4	2.3	12	50	1.45	-
★ SEME610150314E	R0.3	1.5	4	2.3	14	50	1.45	-
★ SEME610150316E	R0.3	1.5	4	2.3	16	50	1.45	-
SEME610150320E	R0.3	1.5	4	2.3	20	50	1.45	-
SEME610150322E	R0.3	1.5	4	2.3	22	60	1.45	-
SEME610150326E	R0.3	1.5	4	2.3	26	60	1.45	-
★ SEME610150504E	R0.5	1.5	4	2.3	4	50	1.45	-
★ SEME610150506E	R0.5	1.5	4	2.3	6	50	1.45	-
★ SEME610150508E	R0.5	1.5	4	2.3	8	50	1.45	-
★ SEME610150510E	R0.5	1.5	4	2.3	10	50	1.45	-
★ SEME610150512E	R0.5	1.5	4	2.3	12	50	1.45	-
SEME610150514E	R0.5	1.5	4	2.3	14	50	1.45	-
★ SEME610150516E	R0.5	1.5	4	2.3	16	50	1.45	-

★ : Stock Item

▶ NEXT PAGE

Size	Corner Radius Tolerance (mm)	Mill Dia. Tolerance (mm)	Shank Dia. Tolerance
up to Ø6	± 0.010	0 ~ - 0.012	h5
over Ø6	± 0.015	0 ~ - 0.015	

◎ : Excellent ○ : Good

ISO Material Description	P										M			K						
	Non-alloy steel					Low alloy steel					High alloyed steel, and tool steel			Stainless steel			Grey cast iron		Nodular cast iron	
VDI 3323	1	2	3	4	5	6	7	8	9	10	11	12	13	14	15	16	17	18	19	20
HRC	13	25	28	32	10	29	32	38	15	35	15	23	10	10	26	3	25	42	21	
HB	125	190	250	270	300	180	275	300	350	200	325	200	240	180	180	260	160	250	130	230
Recommend	○	○	◎	◎	◎	○	◎	◎	◎	◎	◎	◎	◎	○	○	○	○	○	○	

ISO Material Description	N										S					H					
	Aluminum-wrought alloy		Aluminum-cast, alloyed			Copper and Copper Alloys (Bronze / Brass)			Non Metallic Materials		Heat Resistant Super Alloys					Titanium Alloys		Hardened steel	Chilled Cast Iron	Hardened Cast Iron	
VDI 3323	21	22	23	24	25	26	27	28	29	30	31	32	33	34	35	36	37	38	39	40	41
HRC	15	30	25	38	34	15	30	25	38	34	15	30	25	38	34	55	60	55	60	42	55
HB	60	100	75	90	130	110	90	100			200	280	250	350	320	400 Rm	1050 Rm	550	630	400	550
Recommend																		○	◎	◎	○

YG 4G MILL END MILLS

PLAIN SHANK

SEME61 SERIES

CARBIDE, 2 FLUTE CORNER RADIUS with EXTENDED NECK

- **VOLLHARTMETALL, 2 SCHNEIDEN ECKENRADIUS mit ABGESETZTEM SCHAFTTETL**
- **Fraise carbure, 2 dents, torique, détalonnée**
- **MD, 2 TAGLIANTI, SCARICATA, TORICA**

- ▶ Due to new coating and new tool geometry, outstanding cutting ability and wear resistance.
 - ▶ Excellent for cutting prehardened steels, carbon steels, alloy steels of molds and dies, up to HRC55 and machine parts.
 - ▶ Available various products like regular length and long shank end mills etc.
 - ▶ Available various corner radius end mills, from min. 0.02mm corner radius to max. 2.0mm corner radius.
 - ▶ Available more various effective length and overall length end mills than previous standard products.
- ▶ Aufgrund einer neuartigen Beschichtung und neuer Werkzeuggeometrien hervorragende Schnittleistung und Verschleißfestigkeit
 - ▶ Ausgezeichnet geeignet für das Fräsen von vorvergütetem Stahl, kohlenstoff Stahl, legiertem Stahl für Formen, bis HRC55 und Maschinenbauteile.
 - ▶ Erhältlich in den Schaft-Ausführungen: standard und lang.
 - ▶ Erhältlich in verschiedenen Eckradien-Ausführungen: von 0,02mm bis zu 2,0mm Eckradius.
 - ▶ Erhältlich in verschiedenen gesamt Längen und effektiv Längen. Mehr Auswahlmöglichkeiten als bei den bisherigen standard Produkten.

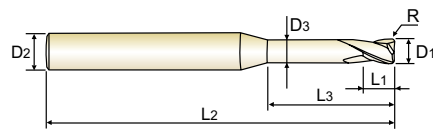

CARBIDE
2
30°
±0.010
±0.015
PLAIN
P.292-299

Ø0.2-Ø6 Ø7-Ø20

Unit : mm

EDP No.	Corner Radius	Mill Diameter	Shank Diameter	Length of Cut	Length Below Shank	Overall Length	Neck Diameter	Remark
	R	D1	D2	L1	L3	L2	D3	
SEME610150520E	R0.5	1.5	4	2.3	20	50	1.45	-
SEME610150522E	R0.5	1.5	4	2.3	22	60	1.45	-
SEME610150526E	R0.5	1.5	4	2.3	26	60	1.45	-
★ SEME610200106E	R0.1	2.0	4	3	6	50	1.95	-
★ SEME610200108E	R0.1	2.0	4	3	8	50	1.95	-
★ SEME610200110E	R0.1	2.0	4	3	10	50	1.95	-
★ SEME610200112E	R0.1	2.0	4	3	12	50	1.95	-
SEME610200114E	R0.1	2.0	4	3	14	50	1.95	-
SEME610200116E	R0.1	2.0	4	3	16	50	1.95	-
SEME610200120E	R0.1	2.0	4	3	20	50	1.95	-
SEME610200122E	R0.1	2.0	4	3	22	60	1.95	-
SEME610200126E	R0.1	2.0	4	3	26	60	1.95	-
SEME610200130E	R0.1	2.0	4	3	30	70	1.95	-
★ SEME610200206E	R0.2	2.0	4	3	6	50	1.95	-
★ SEME610200208E	R0.2	2.0	4	3	8	50	1.95	-
★ SEME610200210E	R0.2	2.0	4	3	10	50	1.95	-
★ SEME610200212E	R0.2	2.0	4	3	12	50	1.95	-
★ SEME610200214E	R0.2	2.0	4	3	14	50	1.95	-
★ SEME610200216E	R0.2	2.0	4	3	16	50	1.95	-
★ SEME610200220E	R0.2	2.0	4	3	20	50	1.95	-
SEME610200222E	R0.2	2.0	4	3	22	60	1.95	-
SEME610200226E	R0.2	2.0	4	3	26	60	1.95	-
SEME610200230E	R0.2	2.0	4	3	30	70	1.95	-
★ SEME610200306E	R0.3	2.0	4	3	6	50	1.95	-

★ : Stock Item

▶ NEXT PAGE

Size	Corner Radius Tolerance (mm)	Mill Dia. Tolerance (mm)	Shank Dia. Tolerance
up to Ø6	± 0.010	0 ~ - 0.012	h5
over Ø6	± 0.015	0 ~ - 0.015	

◎ : Excellent ○ : Good

ISO Material Description	P											M			K						
	Non-alloy steel					Low alloy steel				High alloyed steel, and tool steel		Stainless steel			Grey cast iron		Nodular cast iron	Malleable cast iron			
VDI 3323	1	2	3	4	5	6	7	8	9	10	11	12	13	14	15	16	17	18	19	20	
HRC		13	25	28	32	10	29	32	38	15	35	15	23	10	10	26	3	25		21	
HB	125	190	250	270	300	180	275	300	350	200	325	200	240	180	180	260	160	250	130	230	
Recommend	○	○	◎	◎	◎	○	◎	◎	◎	○	◎	○	◎	◎	○	○	○	○	○	○	
ISO Material Description	N										S					H					
	Aluminum-wrought alloy		Aluminum-cast, alloyed			Copper and Copper Alloys (Bronze / Brass)			Non Metallic Materials		Heat Resistant Super Alloys					Titanium Alloys		Hardened steel	Chilled Cast Iron	Hardened Cast Iron	
VDI 3323	21	22	23	24	25	26	27	28	29	30	31	32	33	34	35	36	37	38	39	40	41
HRC											15	30	25	38	34			55	60	42	55
HB	60	100	75	90	130	110	90	100			200	280	250	350	320	400 Rm	1050 Rm	550	630	400	550
Recommend																		◎	◎	◎	○

YG 4G MILL END MILLS

PLAIN SHANK **SEME61** SERIES

CARBIDE, 2 FLUTE CORNER RADIUS with EXTENDED NECK

- VOLLHARTMETALL, 2 SCHNEIDEN ECKENRADIUS mit ABGESETZTEM SCHAFTTETEL
- () Fraise carbure, 2 dents, torique, détalonnée
- () MD, 2 TAGLIENTI, SCARICATA, TORICA

- ▶ Due to new coating and new tool geometry, outstanding cutting ability and wear resistance.
- ▶ Excellent for cutting prehardened steels, carbon steels, alloy steels of molds and dies, up to HRC55 and machine parts.
- ▶ Available various products like regular length and long shank end mills etc.
- ▶ Available various corner radius end mills, from min. 0.02mm corner radius to max. 2.0mm corner radius.
- ▶ Available more various effective length and overall length end mills than previous standard products.

- ▶ Aufgrund einer neuartigen Beschichtung und neuer Werkzeuggeometrien hervorragende Schnittleistung und Verschleißfestigkeit
- ▶ Ausgezeichnet geeignet für das Fräsen von vorvergütetem Stahl, kohlenstoff Stahl, legiertem Stahl für Formen, bis HRC55 und Maschinenbauteile.
- ▶ Erhältlich in den Schaft-Ausführungen: standard und lang.
- ▶ Erhältlich in verschiedenen Eckradien-Ausführungen: von 0,02mm bis zu 2,0mm Eckradius.
- ▶ Erhältlich in verschiedenen gesamt Längen und effektiv Längen. Mehr Auswahlmöglichkeiten als bei den bisherigen standard Produkten.

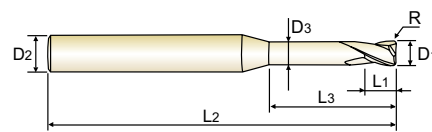

CARBIDE
2
30°
±0.010
±0.015
PLAIN
P.292-299

Ø0.2-Ø6 Ø7-Ø20

Unit : mm

EDP No.	Corner Radius	Mill Diameter	Shank Diameter	Length of Cut	Length Below Shank	Overall Length	Neck Diameter	Remark
	R	D1	D2	L1	L3	L2	D3	
★ SEME610200308E	R0.3	2.0	4	3	8	50	1.95	-
★ SEME610200310E	R0.3	2.0	4	3	10	50	1.95	-
★ SEME610200312E	R0.3	2.0	4	3	12	50	1.95	-
SEME610200314E	R0.3	2.0	4	3	14	50	1.95	-
★ SEME610200316E	R0.3	2.0	4	3	16	50	1.95	-
★ SEME610200320E	R0.3	2.0	4	3	20	50	1.95	-
SEME610200322E	R0.3	2.0	4	3	22	60	1.95	-
SEME610200326E	R0.3	2.0	4	3	26	60	1.95	-
SEME610200330E	R0.3	2.0	4	3	30	70	1.95	-
★ SEME610200506E	R0.5	2.0	4	3	6	50	1.95	-
★ SEME610200508E	R0.5	2.0	4	3	8	50	1.95	-
★ SEME610200510E	R0.5	2.0	4	3	10	50	1.95	-
★ SEME610200512E	R0.5	2.0	4	3	12	50	1.95	-
★ SEME610200514E	R0.5	2.0	4	3	14	50	1.95	-
★ SEME610200516E	R0.5	2.0	4	3	16	50	1.95	-
★ SEME610200520E	R0.5	2.0	4	3	20	50	1.95	-
SEME610200522E	R0.5	2.0	4	3	22	60	1.95	-
★ SEME610200526E	R0.5	2.0	4	3	26	60	1.95	-
★ SEME610200530E	R0.5	2.0	4	3	30	70	1.95	-
SE5E6102005086SE	R0.5	2.0	6	3	8	50	1.95	-
SEME610250108E	R0.1	2.5	4	4	8	50	2.40	-
SEME610250110E	R0.1	2.5	4	4	10	50	2.40	-
SEME610250112E	R0.1	2.5	4	4	12	50	2.40	-
SEME610250114E	R0.1	2.5	4	4	14	50	2.40	-

★ : Stock Item

▶ NEXT PAGE

Size	Corner Radius Tolerance (mm)	Mill Dia. Tolerance (mm)	Shank Dia. Tolerance
up to Ø6	± 0.010	0 ~ - 0.012	h5
over Ø6	± 0.015	0 ~ - 0.015	

◎ : Excellent ○ : Good

ISO Material Description	P										M			K						
	Non-alloy steel					Low alloy steel					High alloyed steel, and tool steel			Stainless steel			Grey cast iron		Nodular cast iron	
VDI 3323	1	2	3	4	5	6	7	8	9	10	11	12	13	14	15	16	17	18	19	20
HRC	13	25	28	32	10	29	32	38	15	35	15	23	10	10	26	3	25		21	
HB	125	190	250	270	300	180	275	300	350	200	325	200	180	180	260	160	250	130	230	
Recommend	○	○	◎	◎	◎	○	◎	◎	◎	◎	◎	◎	◎	○	○	○	○	○	○	

ISO Material Description	N									S						H					
	Aluminum-wrought alloy		Aluminum-cast, alloyed			Copper and Copper Alloys (Bronze / Brass)			Non Metallic Materials		Heat Resistant Super Alloys						Titanium Alloys		Hardened steel	Chilled Cast Iron	Hardened Cast Iron
VDI 3323	21	22	23	24	25	26	27	28	29	30	31	32	33	34	35	36	37	38	39	40	41
HRC	15	30	25	38	34	15	30	25	38	34	15	30	25	38	34	55	60	42	55		
HB	60	100	75	90	130	110	90	100			200	280	250	350	320	400 Rm	1050 Rm	550	630	400	550
Recommend																		○	◎	◎	○

YG 4G MILL END MILLS

PLAIN SHANK

SEME61 SERIES

CARBIDE, 2 FLUTE CORNER RADIUS with EXTENDED NECK

- **VOLLHARTMETALL, 2 SCHNEIDEN ECKENRADIUS mit ABGESETZTEM SCHAFTTETL**
- **Fraise carbure, 2 dents, torique, détalonnée**
- **MD, 2 TAGLIANTI, SCARICATA, TORICA**

- ▶ Due to new coating and new tool geometry, outstanding cutting ability and wear resistance.
- ▶ Excellent for cutting prehardened steels, carbon steels, alloy steels of molds and dies, up to HRC55 and machine parts.
- ▶ Available various products like regular length and long shank end mills etc.
- ▶ Available various corner radius end mills, from min. 0.02mm corner radius to max. 2.0mm corner radius.
- ▶ Available more various effective length and overall length end mills than previous standard products.

- ▶ Aufgrund einer neuartigen Beschichtung und neuer Werkzeuggeometrien hervorragende Schnittleistung und Verschleißfestigkeit
- ▶ Ausgezeichnet geeignet für das Fräsen von vorvergütetem Stahl, kohlenstoff Stahl, legiertem Stahl für Formen, bis HRC55 und Maschinenbauteile.
- ▶ Erhältlich in den Schaft-Ausführungen: standard und lang.
- ▶ Erhältlich in verschiedenen Eckradien-Ausführungen: von 0,02mm bis zu 2,0mm Eckradius.
- ▶ Erhältlich in verschiedenen gesamt Längen und effektiv Längen. Mehr Auswahlmöglichkeiten als bei den bisherigen standard Produkten.

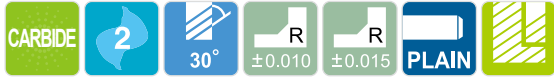
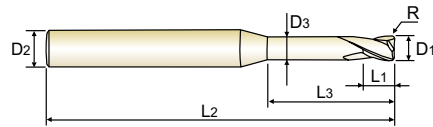

P.292-299

Ø0.2-Ø6 Ø7-Ø20

Unit : mm

EDP No.	Corner Radius	Mill Diameter	Shank Diameter	Length of Cut	Length Below Shank	Overall Length	Neck Diameter	Remark
	R	D1	D2	L1	L3	L2	D3	
SEME610250116E	R0.1	2.5	4	4	16	50	2.40	-
SEME610250120E	R0.1	2.5	4	4	20	50	2.40	-
SEME610250126E	R0.1	2.5	4	4	26	60	2.40	-
SEME610250130E	R0.1	2.5	4	4	30	70	2.40	-
SEME610250208E	R0.2	2.5	4	4	8	50	2.40	-
SEME610250210E	R0.2	2.5	4	4	10	50	2.40	-
SEME610250212E	R0.2	2.5	4	4	12	50	2.40	-
SEME610250214E	R0.2	2.5	4	4	14	50	2.40	-
SEME610250216E	R0.2	2.5	4	4	16	50	2.40	-
SEME610250220E	R0.2	2.5	4	4	20	50	2.40	-
SEME610250226E	R0.2	2.5	4	4	26	60	2.40	-
SEME610250230E	R0.2	2.5	4	4	30	70	2.40	-
SEME610250308E	R0.3	2.5	4	4	8	50	2.40	-
SEME610250310E	R0.3	2.5	4	4	10	50	2.40	-
SEME610250312E	R0.3	2.5	4	4	12	50	2.40	-
SEME610250314E	R0.3	2.5	4	4	14	50	2.40	-
SEME610250316E	R0.3	2.5	4	4	16	50	2.40	-
SEME610250320E	R0.3	2.5	4	4	20	50	2.40	-
SEME610250326E	R0.3	2.5	4	4	26	60	2.40	-
SEME610250330E	R0.3	2.5	4	4	30	70	2.40	-
★ SEME610250508E	R0.5	2.5	4	4	8	50	2.40	-
SEME610250510E	R0.5	2.5	4	4	10	50	2.40	-
SEME610250512E	R0.5	2.5	4	4	12	50	2.40	-
SEME610250514E	R0.5	2.5	4	4	14	50	2.40	-

★ : Stock Item

▶ NEXT PAGE

Size	Corner Radius Tolerance (mm)	Mill Dia. Tolerance (mm)	Shank Dia. Tolerance
up to Ø6	± 0.010	0 ~ - 0.012	h5
over Ø6	± 0.015	0 ~ - 0.015	

◎ : Excellent ○ : Good

ISO Material Description	P											M			K						
	Non-alloy steel					Low alloy steel				High alloyed steel, and tool steel		Stainless steel			Grey cast iron		Nodular cast iron		Malleable cast iron		
VDI 3323	1	2	3	4	5	6	7	8	9	10	11	12	13	14	15	16	17	18	19	20	
HRC		13	25	28	32	10	29	32	38	15	35	15	23	10	10	26	3	25		21	
HB	125	190	250	270	300	180	275	300	350	200	325	200	240	180	180	260	160	250	130	230	
Recommend	○	○	◎	◎	◎	○	◎	◎	◎	○	◎	○	○	○	○	○	○	○	○	○	
ISO Material Description	N										S					H					
	Aluminum-wrought alloy		Aluminum-cast, alloyed			Copper and Copper Alloys (Bronze / Brass)			Non Metallic Materials		Heat Resistant Super Alloys					Titanium Alloys		Hardened steel	Chilled Cast Iron	Hardened Cast Iron	
VDI 3323	21	22	23	24	25	26	27	28	29	30	31	32	33	34	35	36	37	38	39	40	41
HRC											15	30	25	38	34			55	60	42	55
HB	60	100	75	90	130	110	90	100			200	280	250	350	320	400 Rm	1050 Rm	550	630	400	550
Recommend																		◎	◎	◎	○

YG 4G MILL END MILLS

PLAIN SHANK **SEME61** SERIES

CARBIDE, 2 FLUTE CORNER RADIUS with EXTENDED NECK

- VOLLHARTMETALL, 2 SCHNEIDEN ECKENRADIUS mit ABGESETZTEM SCHAFTTETEL
- () Fraise carbure, 2 dents, torique, détalonnée
- () MD, 2 TAGLIENTI, SCARICATA, TORICA

- ▶ Due to new coating and new tool geometry, outstanding cutting ability and wear resistance.
- ▶ Excellent for cutting prehardened steels, carbon steels, alloy steels of molds and dies, up to HRC55 and machine parts.
- ▶ Available various products like regular length and long shank end mills etc.
- ▶ Available various corner radius end mills, from min. 0.02mm corner radius to max. 2.0mm corner radius.
- ▶ Available more various effective length and overall length end mills than previous standard products.

- ▶ Aufgrund einer neuartigen Beschichtung und neuer Werkzeuggeometrien hervorragende Schnittleistung und Verschleißfestigkeit
- ▶ Ausgezeichnet geeignet für das Fräsen von vorvergütetem Stahl, kohlenstoff Stahl, legiertem Stahl für Formen, bis HRC55 und Maschinenbauteile.
- ▶ Erhältlich in den Schaft-Ausführungen: standard und lang.
- ▶ Erhältlich in verschiedenen Eckradien-Ausführungen: von 0,02mm bis zu 2,0mm Eckradius.
- ▶ Erhältlich in verschiedenen gesamt Längen und effektiv Längen. Mehr Auswahlmöglichkeiten als bei den bisherigen standard Produkten.

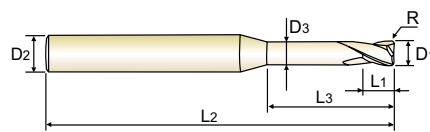

CARBIDE
2
30°
±0.010
±0.015
PLAIN
P.292-299

Ø0.2-Ø6 Ø7-Ø20

Unit : mm

EDP No.	Corner Radius	Mill Diameter	Shank Diameter	Length of Cut	Length Below Shank	Overall Length	Neck Diameter	Remark
	R	D1	D2	L1	L3	L2	D3	
SEME610250516E	R0.5	2.5	4	4	16	50	2.40	-
SEME610250520E	R0.5	2.5	4	4	20	50	2.40	-
SEME610250526E	R0.5	2.5	4	4	26	60	2.40	-
SEME610250530E	R0.5	2.5	4	4	30	70	2.40	-
SEME610300108E	R0.1	3.0	6	4.5	8	50	2.85	-
★ SEME610300110E	R0.1	3.0	6	4.5	10	50	2.85	-
★ SEME610300112E	R0.1	3.0	6	4.5	12	50	2.85	-
SEME610300114E	R0.1	3.0	6	4.5	14	60	2.85	-
★ SEME610300116E	R0.1	3.0	6	4.5	16	60	2.85	-
★ SEME610300120E	R0.1	3.0	6	4.5	20	60	2.85	-
SEME610300126E	R0.1	3.0	6	4.5	26	65	2.85	-
SEME610300130E	R0.1	3.0	6	4.5	30	70	2.85	-
SEME610300135E	R0.1	3.0	6	4.5	35	70	2.85	-
SEME610300140E	R0.1	3.0	6	4.5	40	80	2.85	-
★ SEME610300208E	R0.2	3.0	6	4.5	8	50	2.85	-
★ SEME610300210E	R0.2	3.0	6	4.5	10	50	2.85	-
★ SEME610300212E	R0.2	3.0	6	4.5	12	50	2.85	-
SEME610300214E	R0.2	3.0	6	4.5	14	60	2.85	-
★ SEME610300216E	R0.2	3.0	6	4.5	16	60	2.85	-
★ SEME610300220E	R0.2	3.0	6	4.5	20	60	2.85	-
★ SEME610300226E	R0.2	3.0	6	4.5	26	65	2.85	-
SEME610300230E	R0.2	3.0	6	4.5	30	70	2.85	-
SEME610300235E	R0.2	3.0	6	4.5	35	70	2.85	-
SEME610300240E	R0.2	3.0	6	4.5	40	80	2.85	-

★ : Stock Item

▶ NEXT PAGE

Size	Corner Radius Tolerance (mm)	Mill Dia. Tolerance (mm)	Shank Dia. Tolerance
up to Ø6	± 0.010	0 ~ - 0.012	h5
over Ø6	± 0.015	0 ~ - 0.015	

◎ : Excellent ○ : Good

ISO Material Description	P										M			K						
	Non-alloy steel					Low alloy steel					High alloyed steel, and tool steel			Stainless steel			Grey cast iron		Nodular cast iron	
VDI 3323	1	2	3	4	5	6	7	8	9	10	11	12	13	14	15	16	17	18	19	20
HRC		13	25	28	32	10	29	32	38	15	35	15	23	10	10	26	3	25	42	21
HB	125	190	250	270	300	180	275	300	350	200	325	200	240	180	180	260	160	250	130	230
Recommend	○	○	◎	◎	◎	○	◎	◎	◎	◎	◎				○	○	○	○	○	○

ISO Material Description	N										S					H					
	Aluminum-wrought alloy		Aluminum-cast, alloyed			Copper and Copper Alloys (Bronze / Brass)			Non Metallic Materials		Heat Resistant Super Alloys					Titanium Alloys		Hardened steel	Chilled Cast Iron	Hardened Cast Iron	
VDI 3323	21	22	23	24	25	26	27	28	29	30	31	32	33	34	35	36	37	38	39	40	41
HRC											15	30	25	38	34			55	60	42	55
HB	60	100	75	90	130	110	90	100			200	280	250	350	320	400 Rm	1050 Rm	550	630	400	550
Recommend																		○	◎	○	○

YG 4G MILL END MILLS

PLAIN SHANK

SEME61 SERIES

CARBIDE, 2 FLUTE CORNER RADIUS with EXTENDED NECK

- **VOLLHARTMETALL, 2 SCHNEIDEN ECKENRADIUS mit ABGESETZTEM SCHAFTTETL**
- **Fraise carbure, 2 dents, torique, détalonnée**
- **MD, 2 TAGLIANTI, SCARICATA, TORICA**

- ▶ Due to new coating and new tool geometry, outstanding cutting ability and wear resistance.
- ▶ Excellent for cutting prehardened steels, carbon steels, alloy steels of molds and dies, up to HRC55 and machine parts.
- ▶ Available various products like regular length and long shank end mills etc.
- ▶ Available various corner radius end mills, from min. 0.02mm corner radius to max. 2.0mm corner radius.
- ▶ Available more various effective length and overall length end mills than previous standard products.

- ▶ Aufgrund einer neuartigen Beschichtung und neuer Werkzeuggeometrien hervorragende Schnittleistung und Verschleißfestigkeit
- ▶ Ausgezeichnet geeignet für das Fräsen von vorvergütetem Stahl, kohlenstoff Stahl, legiertem Stahl für Formen, bis HRC55 und Maschinenbauteile.
- ▶ Erhältlich in den Schaft-Ausführungen: standard und lang.
- ▶ Erhältlich in verschiedenen Eckradien-Ausführungen: von 0,02mm bis zu 2,0mm Eckradius.
- ▶ Erhältlich in verschiedenen gesamt Längen und effektiv Längen. Mehr Auswahlmöglichkeiten als bei den bisherigen standard Produkten.

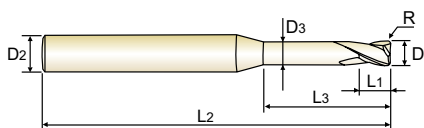

P.292-299

Ø0.2-Ø6 Ø7-Ø20

Unit : mm

EDP No.	Corner Radius	Mill Diameter	Shank Diameter	Length of Cut	Length Below Shank	Overall Length	Neck Diameter	Remark
	R	D1	D2	L1	L3	L2	D3	
★ SEME610300308E	R0.3	3.0	6	4.5	8	50	2.85	-
★ SEME610300310E	R0.3	3.0	6	4.5	10	50	2.85	-
★ SEME610300312E	R0.3	3.0	6	4.5	12	50	2.85	-
★ SEME610300314E	R0.3	3.0	6	4.5	14	60	2.85	-
★ SEME610300316E	R0.3	3.0	6	4.5	16	60	2.85	-
★ SEME610300320E	R0.3	3.0	6	4.5	20	60	2.85	-
★ SEME610300326E	R0.3	3.0	6	4.5	26	65	2.85	-
SEME610300330E	R0.3	3.0	6	4.5	30	70	2.85	-
SEME610300335E	R0.3	3.0	6	4.5	35	70	2.85	-
SEME610300340E	R0.3	3.0	6	4.5	40	80	2.85	-
★ SEME610300508E	R0.5	3.0	6	4.5	8	50	2.85	-
★ SEME610300510E	R0.5	3.0	6	4.5	10	50	2.85	-
★ SEME610300512E	R0.5	3.0	6	4.5	12	50	2.85	-
★ SEME610300514E	R0.5	3.0	6	4.5	14	60	2.85	-
★ SEME610300516E	R0.5	3.0	6	4.5	16	60	2.85	-
★ SEME610300520E	R0.5	3.0	6	4.5	20	60	2.85	-
★ SEME610300526E	R0.5	3.0	6	4.5	26	65	2.85	-
★ SEME610300530E	R0.5	3.0	6	4.5	30	70	2.85	-
★ SEME610300535E	R0.5	3.0	6	4.5	35	70	2.85	-
SEME610300540E	R0.5	3.0	6	4.5	40	80	2.85	-
★ SEME610301008E	R1.0	3.0	6	4.5	8	50	2.85	-
★ SEME610301010E	R1.0	3.0	6	4.5	10	50	2.85	-
★ SEME610301012E	R1.0	3.0	6	4.5	12	50	2.85	-
SEME610301014E	R1.0	3.0	6	4.5	14	60	2.85	-

★ : Stock Item

▶ NEXT PAGE

Size	Corner Radius Tolerance (mm)	Mill Dia. Tolerance (mm)	Shank Dia. Tolerance
up to Ø6	± 0.010	0 ~ - 0.012	h5
over Ø6	± 0.015	0 ~ - 0.015	

◎ : Excellent ○ : Good

ISO Material Description	P											M			K						
	Non-alloy steel					Low alloy steel				High alloyed steel, and tool steel		Stainless steel			Grey cast iron		Nodular cast iron		Malleable cast iron		
VDI 3323	1	2	3	4	5	6	7	8	9	10	11	12	13	14	15	16	17	18	19	20	
HRC		13	25	28	32	10	29	32	38	15	35	15	23	10	10	26	3	25		21	
HB	125	190	250	270	300	180	275	300	350	200	325	200	240	180	180	260	160	250	130	230	
Recommend	○	○	◎	◎	◎	○	◎	◎	◎	○	◎	○	○	○	○	○	○	○	○	○	
ISO Material Description	N										S						H				
	Aluminum-wrought alloy		Aluminum-cast, alloyed			Copper and Copper Alloys (Bronze / Brass)			Non Metallic Materials		Heat Resistant Super Alloys				Titanium Alloys		Hardened steel	Chilled Cast Iron	Hardened Cast Iron		
VDI 3323	21	22	23	24	25	26	27	28	29	30	31	32	33	34	35	36	37	38	39	40	41
HRC											15	30	25	38	34			55	60	42	55
HB	60	100	75	90	130	110	90	100			200	280	250	350	320	400 Rm	1050 Rm	550	630	400	550
Recommend																		◎	◎	◎	○

YG 4G MILL END MILLS

PLAIN SHANK **SEME61** SERIES

CARBIDE, 2 FLUTE CORNER RADIUS with EXTENDED NECK

- VOLLHARTMETALL, 2 SCHNEIDEN ECKENRADIUS mit ABGESETZTEM SCHAFTTETEL
- Fraise carbure, 2 dents, torique, détalonnée
- MD, 2 TAGLIENTI, SCARICATA, TORICA

- ▶ Due to new coating and new tool geometry, outstanding cutting ability and wear resistance.
- ▶ Excellent for cutting prehardened steels, carbon steels, alloy steels of molds and dies, up to HRC55 and machine parts.
- ▶ Available various products like regular length and long shank end mills etc.
- ▶ Available various corner radius end mills, from min. 0.02mm corner radius to max. 2.0mm corner radius.
- ▶ Available more various effective length and overall length end mills than previous standard products.

- ▶ Aufgrund einer neuartigen Beschichtung und neuer Werkzeuggeometrien hervorragende Schnittleistung und Verschleißfestigkeit
- ▶ Ausgezeichnet geeignet für das Fräsen von vorvergütetem Stahl, kohlenstoff Stahl, legiertem Stahl für Formen, bis HRC55 und Maschinenbauteile.
- ▶ Erhältlich in den Schaft-Ausführungen: standard und lang.
- ▶ Erhältlich in verschiedenen Eckradien-Ausführungen: von 0,02mm bis zu 2,0mm Eckradius.
- ▶ Erhältlich in verschiedenen gesamt Längen und effektiv Längen. Mehr Auswahlmöglichkeiten als bei den bisherigen standard Produkten.

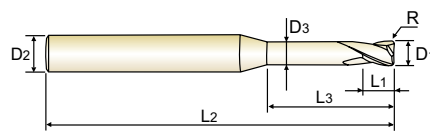

CARBIDE
2
30°
R ±0.010
R ±0.015
PLAIN
P.292-299

Ø0.2-Ø6 Ø7-Ø20

Unit : mm

EDP No.	Corner Radius	Mill Diameter	Shank Diameter	Length of Cut	Length Below Shank	Overall Length	Neck Diameter	Remark
	R	D1	D2	L1	L3	L2	D3	
★ SEME610301016E	R1.0	3.0	6	4.5	16	60	2.85	-
★ SEME610301020E	R1.0	3.0	6	4.5	20	60	2.85	-
★ SEME610301026E	R1.0	3.0	6	4.5	26	65	2.85	-
SEME610301030E	R1.0	3.0	6	4.5	30	70	2.85	-
SEME610301035E	R1.0	3.0	6	4.5	35	70	2.85	-
SEME610301040E	R1.0	3.0	6	4.5	40	80	2.85	-
★ SEME610400110E	R0.1	4.0	6	6	10	50	3.85	-
★ SEME610400112E	R0.1	4.0	6	6	12	50	3.85	-
SEME610400114E	R0.1	4.0	6	6	14	60	3.85	-
★ SEME610400116E	R0.1	4.0	6	6	16	60	3.85	-
★ SEME610400120E	R0.1	4.0	6	6	20	60	3.85	-
SEME610400126E	R0.1	4.0	6	6	26	65	3.85	-
SEME610400130E	R0.1	4.0	6	6	30	70	3.85	-
SEME610400135E	R0.1	4.0	6	6	35	70	3.85	-
SEME610400140E	R0.1	4.0	6	6	40	80	3.85	-
SEME610400145E	R0.1	4.0	6	6	45	90	3.85	-
SEME610400150E	R0.1	4.0	6	6	50	100	3.85	-
★ SEME610400210E	R0.2	4.0	6	6	10	50	3.85	-
★ SEME610400212E	R0.2	4.0	6	6	12	50	3.85	-
SEME610400214E	R0.2	4.0	6	6	14	60	3.85	-
★ SEME610400216E	R0.2	4.0	6	6	16	60	3.85	-
★ SEME610400220E	R0.2	4.0	6	6	20	60	3.85	-
★ SEME610400226E	R0.2	4.0	6	6	26	65	3.85	-
SEME610400230E	R0.2	4.0	6	6	30	70	3.85	-

★ : Stock Item

▶ NEXT PAGE

Size	Corner Radius Tolerance (mm)	Mill Dia. Tolerance (mm)	Shank Dia. Tolerance
up to Ø6	± 0.010	0 ~ - 0.012	h5
over Ø6	± 0.015	0 ~ - 0.015	

◎ : Excellent ○ : Good

ISO Material Description	P										M			K						
	Non-alloy steel					Low alloy steel					High alloyed steel, and tool steel			Stainless steel		Grey cast iron		Nodular cast iron		Malleable cast iron
VDI 3323	1	2	3	4	5	6	7	8	9	10	11	12	13	14	15	16	17	18	19	20
HRC		13	25	28	32	10	29	32	38	15	35	15	23	10	10	26	3	25	42	21
HB	125	190	250	270	300	180	275	300	350	200	325	200	240	180	180	260	160	250	130	230
Recommend	○	○	◎	◎	◎	○	◎	◎	◎	◎	◎	○	○	○	○	○	○	○	○	○

ISO Material Description	N									S						H					
	Aluminum-wrought alloy		Aluminum-cast, alloyed			Copper and Copper Alloys (Bronze / Brass)			Non Metallic Materials		Heat Resistant Super Alloys						Titanium Alloys		Hardened steel	Chilled Cast Iron	Hardened Cast Iron
VDI 3323	21	22	23	24	25	26	27	28	29	30	31	32	33	34	35	36	37	38	39	40	41
HRC											15	30	25	38	34			55	60	42	55
HB	60	100	75	90	130	110	90	100			200	280	250	350	320	400 Rm	1050 Rm	550	630	400	550
Recommend																		○	◎	○	○

YG 4G MILL END MILLS

PLAIN SHANK

SEME61 SERIES

CARBIDE, 2 FLUTE CORNER RADIUS with EXTENDED NECK

- **VOLLHARTMETALL, 2 SCHNEIDEN ECKENRADIUS mit ABGESETZTEM SCHAFTTETL**
- **Fraise carbure, 2 dents, torique, détalonnée**
- **MD, 2 TAGLIANTI, SCARICATA, TORICA**

- ▶ Due to new coating and new tool geometry, outstanding cutting ability and wear resistance.
 - ▶ Excellent for cutting prehardened steels, carbon steels, alloy steels of molds and dies, up to HRC55 and machine parts.
 - ▶ Available various products like regular length and long shank end mills etc.
 - ▶ Available various corner radius end mills, from min. 0.02mm corner radius to max. 2.0mm corner radius.
 - ▶ Available more various effective length and overall length end mills than previous standard products.
- ▶ Aufgrund einer neuartigen Beschichtung und neuer Werkzeuggeometrien hervorragende Schnittleistung und Verschleißfestigkeit
 - ▶ Ausgezeichnet geeignet für das Fräsen von vorvergütetem Stahl, kohlenstoff Stahl, legiertem Stahl für Formen, bis HRC55 und Maschinenbauteile.
 - ▶ Erhältlich in den Schaft-Ausführungen: standard und lang.
 - ▶ Erhältlich in verschiedenen Eckradien-Ausführungen: von 0,02mm bis zu 2,0mm Eckradius.
 - ▶ Erhältlich in verschiedenen gesamt Längen und effektiv Längen. Mehr Auswahlmöglichkeiten als bei den bisherigen standard Produkten.

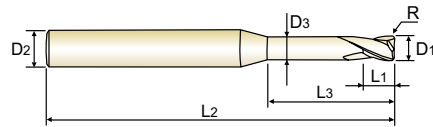

CARBIDE
2
30°
±0.010
±0.015
PLAIN
P.292-299

Unit : mm

EDP No.	Corner Radius	Mill Diameter	Shank Diameter	Length of Cut	Length Below Shank	Overall Length	Neck Diameter	Remark
	R	D1	D2	L1	L3	L2	D3	
SEME610400235E	R0.2	4.0	6	6	35	70	3.85	-
SEME610400240E	R0.2	4.0	6	6	40	80	3.85	-
SEME610400245E	R0.2	4.0	6	6	45	90	3.85	-
SEME610400250E	R0.2	4.0	6	6	50	100	3.85	-
SEME610400310E	R0.3	4.0	6	6	10	50	3.85	-
★ SEME610400312E	R0.3	4.0	6	6	12	50	3.85	-
SEME610400314E	R0.3	4.0	6	6	14	50	3.85	-
★ SEME610400316E	R0.3	4.0	6	6	16	50	3.85	-
★ SEME610400320E	R0.3	4.0	6	6	20	50	3.85	-
★ SEME610400326E	R0.3	4.0	6	6	26	65	3.85	-
SEME610400330E	R0.3	4.0	6	6	30	70	3.85	-
SEME610400335E	R0.3	4.0	6	6	35	70	3.85	-
SEME610400340E	R0.3	4.0	6	6	40	80	3.85	-
SEME610400345E	R0.3	4.0	6	6	45	90	3.85	-
SEME610400350E	R0.3	4.0	6	6	50	100	3.85	-
★ SEME610400510E	R0.5	4.0	6	6	10	50	3.85	-
★ SEME610400512E	R0.5	4.0	6	6	12	50	3.85	-
★ SEME610400514E	R0.5	4.0	6	6	14	60	3.85	-
★ SEME610400516E	R0.5	4.0	6	6	16	60	3.85	-
★ SEME610400520E	R0.5	4.0	6	6	20	60	3.85	-
★ SEME610400526E	R0.5	4.0	6	6	26	65	3.85	-
★ SEME610400530E	R0.5	4.0	6	6	30	70	3.85	-
★ SEME610400535E	R0.5	4.0	6	6	35	70	3.85	-
SEME610400540E	R0.5	4.0	6	6	40	80	3.85	-

★ : Stock Item

▶ NEXT PAGE

Size	Corner Radius Tolerance (mm)	Mill Dia. Tolerance (mm)	Shank Dia. Tolerance
up to Ø6	± 0.010	0 ~ - 0.012	h5
over Ø6	± 0.015	0 ~ - 0.015	

◎ : Excellent ○ : Good

ISO Material Description	P											M			K						
	Non-alloy steel					Low alloy steel				High alloyed steel, and tool steel		Stainless steel			Grey cast iron		Nodular cast iron		Malleable cast iron		
VDI 3323	1	2	3	4	5	6	7	8	9	10	11	12	13	14	15	16	17	18	19	20	
HRC		13	25	28	32	10	29	32	38	15	35	15	23	10	10	26	3	25		21	
HB	125	190	250	270	300	180	275	300	350	200	325	200	240	180	180	260	160	250	130	230	
Recommend	○	○	◎	◎	◎	○	◎	◎	◎	○	◎	○	◎	◎	○	○	○	○	○	○	
ISO Material Description	N										S					H					
	Aluminum-wrought alloy		Aluminum-cast, alloyed			Copper and Copper Alloys (Bronze / Brass)			Non Metallic Materials		Heat Resistant Super Alloys					Titanium Alloys		Hardened steel	Chilled Cast Iron	Hardened Cast Iron	
VDI 3323	21	22	23	24	25	26	27	28	29	30	31	32	33	34	35	36	37	38	39	40	41
HRC											15	30	25	38	34			55	60	42	55
HB	60	100	75	90	130	110	90	100			200	280	250	350	320	400 Rm	1050 Rm	550	630	400	550
Recommend																		◎	◎	◎	○

YG 4G MILL END MILLS

PLAIN SHANK **SEME61** SERIES

CARBIDE, 2 FLUTE CORNER RADIUS with EXTENDED NECK

- VOLLHARTMETALL, 2 SCHNEIDEN ECKENRADIUS mit ABGESETZTEM SCHAFTTETEL
- Fraise carbure, 2 dents, torique, détalonnée
- MD, 2 TAGLIENTI, SCARICATA, TORICA

- ▶ Due to new coating and new tool geometry, outstanding cutting ability and wear resistance.
- ▶ Excellent for cutting prehardened steels, carbon steels, alloy steels of molds and dies, up to HRC55 and machine parts.
- ▶ Available various products like regular length and long shank end mills etc.
- ▶ Available various corner radius end mills, from min. 0.02mm corner radius to max. 2.0mm corner radius.
- ▶ Available more various effective length and overall length end mills than previous standard products.

- ▶ Aufgrund einer neuartigen Beschichtung und neuer Werkzeuggeometrien hervorragende Schnittleistung und Verschleißfestigkeit
- ▶ Ausgezeichnet geeignet für das Fräsen von vorvergütetem Stahl, kohlenstoff Stahl, legiertem Stahl für Formen, bis HRC55 und Maschinenbauteile.
- ▶ Erhältlich in den Schaft-Ausführungen: standard und lang.
- ▶ Erhältlich in verschiedenen Eckradien-Ausführungen: von 0,02mm bis zu 2,0mm Eckradius.
- ▶ Erhältlich in verschiedenen gesamt Längen und effektiv Längen. Mehr Auswahlmöglichkeiten als bei den bisherigen standard Produkten.

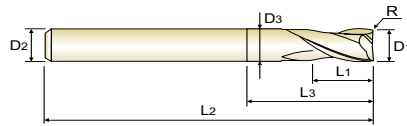

CARBIDE 2 30° ±0.010 ±0.015 PLAIN P.292-299

Unit : mm

EDP No.	Corner Radius	Mill Diameter	Shank Diameter	Length of Cut	Length Below Shank	Overall Length	Neck Diameter	Remark
	R	D1	D2	L1	L3	L2	D3	
SEME610400545E	R0.5	4.0	6	6	45	90	3.85	-
SEME610400550E	R0.5	4.0	6	6	50	100	3.85	-
★ SEME610401010E	R1.0	4.0	6	6	10	50	3.85	-
★ SEME610401012E	R1.0	4.0	6	6	12	50	3.85	-
SEME610401014E	R1.0	4.0	6	6	14	60	3.85	-
★ SEME610401016E	R1.0	4.0	6	6	16	60	3.85	-
★ SEME610401020E	R1.0	4.0	6	6	20	60	3.85	-
★ SEME610401026E	R1.0	4.0	6	6	26	65	3.85	-
★ SEME610401030E	R1.0	4.0	6	6	30	70	3.85	-
SEME610401035E	R1.0	4.0	6	6	35	70	3.85	-
★ SEME610401040E	R1.0	4.0	6	6	40	80	3.85	-
SEME610401045E	R1.0	4.0	6	6	45	90	3.85	-
SEME610401050E	R1.0	4.0	6	6	50	100	3.85	-
SEME6105001E	R0.1	5.0	6	8	15	60	4.85	-
SEME6105002E	R0.2	5.0	6	8	15	60	4.85	-
SEME6105003E	R0.3	5.0	6	8	15	60	4.85	-
SEME6105005E	R0.5	5.0	6	8	15	60	4.85	-
SEME6105010E	R1.0	5.0	6	8	15	60	4.85	-
SEME6105015E	R1.5	5.0	6	8	15	60	4.85	-
SEME6105020E	R2.0	5.0	6	8	15	60	4.85	-
SEME6106001E	R0.1	6.0	6	9	20	60	5.85	Regular
★ SEME6106002E	R0.2	6.0	6	9	20	60	5.85	Regular
★ SEME6106003E	R0.3	6.0	6	9	20	60	5.85	Regular
★ SEME6106005E	R0.5	6.0	6	9	20	60	5.85	Regular

★ : Stock Item

▶ NEXT PAGE

Size	Corner Radius Tolerance (mm)	Mill Dia. Tolerance (mm)	Shank Dia. Tolerance
up to Ø6	± 0.010	0 ~ - 0.012	h5
over Ø6	± 0.015	0 ~ - 0.015	

◎ : Excellent ○ : Good

ISO Material Description	P										M			K						
	Non-alloy steel					Low alloy steel					High alloyed steel, and tool steel			Stainless steel			Grey cast iron		Nodular cast iron	
VDI 3323	1	2	3	4	5	6	7	8	9	10	11	12	13	14	15	16	17	18	19	20
HRC	13	25	28	32	10	29	32	38	15	35	15	23	10	10	26	3	25	42	21	
HB	125	190	250	270	300	180	275	300	350	200	325	200	180	180	260	160	250	130	230	
Recommend	○	○	◎	◎	◎	○	◎	◎	◎	◎	◎	◎	◎	○	○	○	○	○	○	

ISO Material Description	N										S					H					
	Aluminum-wrought alloy		Aluminum-cast, alloyed			Copper and Copper Alloys (Bronze / Brass)			Non Metallic Materials		Heat Resistant Super Alloys					Titanium Alloys		Hardened steel	Chilled Cast Iron	Hardened Cast Iron	
VDI 3323	21	22	23	24	25	26	27	28	29	30	31	32	33	34	35	36	37	38	39	40	41
HRC	15	30	25	38	34	15	30	25	38	34	200	280	250	350	320	400 Rm	1050 Rm	550	630	400	550
HB	60	100	75	90	130	110	90	100													
Recommend																				◎	○

YG 4G MILL END MILLS

PLAIN SHANK

SEME61 SERIES

CARBIDE, 2 FLUTE CORNER RADIUS with EXTENDED NECK

- **VOLLHARTMETALL, 2 SCHNEIDEN ECKENRADIUS mit ABGESETZTEM SCHAFTTETL**
- **Fraise carbure, 2 dents, torique, détalonnée**
- **MD, 2 TAGLIANTI, SCARICATA, TORICA**

- ▶ Due to new coating and new tool geometry, outstanding cutting ability and wear resistance.
- ▶ Excellent for cutting prehardened steels, carbon steels, alloy steels of molds and dies, up to HRC55 and machine parts.
- ▶ Available various products like regular length and long shank end mills etc.
- ▶ Available various corner radius end mills, from min. 0.02mm corner radius to max. 2.0mm corner radius.
- ▶ Available more various effective length and overall length end mills than previous standard products.

- ▶ Aufgrund einer neuartigen Beschichtung und neuer Werkzeuggeometrien hervorragende Schnittleistung und Verschleißfestigkeit
- ▶ Ausgezeichnet geeignet für das Fräsen von vorvergütetem Stahl, kohlenstoff Stahl, legiertem Stahl für Formen, bis HRC55 und Maschinenbauteile.
- ▶ Erhältlich in den Schaft-Ausführungen: standard und lang.
- ▶ Erhältlich in verschiedenen Eckradien-Ausführungen: von 0,02mm bis zu 2,0mm Eckradius.
- ▶ Erhältlich in verschiedenen gesamt Längen und effektiv Längen. Mehr Auswahlmöglichkeiten als bei den bisherigen standard Produkten.

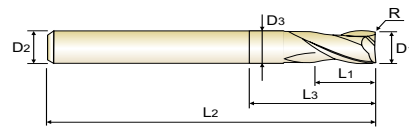

CARBIDE
2
30°
±0.010
±0.015
PLAIN
P.292-299

Unit : mm

EDP No.	Corner Radius	Mill Diameter	Shank Diameter	Length of Cut	Length Below Shank	Overall Length	Neck Diameter	Remark
	R	D1	D2	L1	L3	L2	D3	
★ SEME6106010E	R1.0	6.0	6	9	20	60	5.85	Regular
SEME6106015E	R1.5	6.0	6	9	20	60	5.85	Regular
SEME6106020E	R2.0	6.0	6	9	20	60	5.85	Regular
SEME6106003090E	R0.3	6.0	6	15	30	90	5.85	Long Shank
SEME610600524E	R0.5	6.0	6	9	24	90	5.85	-
★ SEME6106005090E	R0.5	6.0	6	15	30	90	5.85	Long Shank
★ SEME6106010090E	R1.0	6.0	6	15	30	90	5.85	Long Shank
SEME6108001E	R0.1	8.0	8	12	25	70	7.70	Regular
★ SEME6108002E	R0.2	8.0	8	12	25	70	7.70	Regular
★ SEME6108003E	R0.3	8.0	8	12	25	70	7.70	Regular
★ SEME6108005E	R0.5	8.0	8	12	25	70	7.70	Regular
★ SEME6108010E	R1.0	8.0	8	12	25	70	7.70	Regular
SEME6108015E	R1.5	8.0	8	12	25	70	7.70	Regular
SEME6108020E	R2.0	8.0	8	12	25	70	7.70	Regular
SEME6108003100E	R0.3	8.0	8	20	35	100	7.70	Long Shank
★ SEME6108005100E	R0.5	8.0	8	20	35	100	7.70	Long Shank
★ SEME6108010100E	R1.0	8.0	8	20	35	100	7.70	Long Shank
SEME6110001E	R0.1	10.0	10	15	30	75	9.70	Regular
SEME6110002E	R0.2	10.0	10	15	30	75	9.70	Regular
★ SEME6110003E	R0.3	10.0	10	15	30	75	9.70	Regular
★ SEME6110005E	R0.5	10.0	10	15	30	75	9.70	Regular
★ SEME6110010E	R1.0	10.0	10	15	30	75	9.70	Regular
SEME6110015E	R1.5	10.0	10	15	30	75	9.70	Regular
SEME6110020E	R2.0	10.0	10	15	30	75	9.70	Regular

★ : Stock Item

▶ NEXT PAGE

Size	Corner Radius Tolerance (mm)	Mill Dia. Tolerance (mm)	Shank Dia. Tolerance
up to Ø6	± 0.010	0 ~ - 0.012	h5
over Ø6	± 0.015	0 ~ - 0.015	

◎ : Excellent ○ : Good

ISO Material Description	P											M			K						
	Non-alloy steel					Low alloy steel				High alloyed steel, and tool steel		Stainless steel			Grey cast iron		Nodular cast iron		Malleable cast iron		
VDI 3323	1	2	3	4	5	6	7	8	9	10	11	12	13	14	15	16	17	18	19	20	
HRC		13	25	28	32	10	29	32	38	15	35	15	23	10	10	26	3	25		21	
HB	125	190	250	270	300	180	275	300	350	200	325	200	240	180	180	260	160	250	130	230	
Recommend	○	○	◎	◎	◎	○	◎	◎	◎	○	◎	○	○	○	○	○	○	○	○	○	
ISO Material Description	N										S						H				
	Aluminum-wrought alloy		Aluminum-cast, alloyed			Copper and Copper Alloys (Bronze / Brass)			Non Metallic Materials		Heat Resistant Super Alloys				Titanium Alloys		Hardened steel	Chilled Cast Iron	Hardened Cast Iron		
VDI 3323	21	22	23	24	25	26	27	28	29	30	31	32	33	34	35	36	37	38	39	40	41
HRC											15	30	25	38	34			55	60	42	55
HB	60	100	75	90	130	110	90	100			200	280	250	350	320	400 Rm	1050 Rm	550	630	400	550
Recommend																		◎	◎	◎	○

YG 4G MILL END MILLS

PLAIN SHANK **SEME61** SERIES

CARBIDE, 2 FLUTE CORNER RADIUS with EXTENDED NECK

- VOLLHARTMETALL, 2 SCHNEIDEN ECKENRADIUS mit ABGESETZTEM SCHAFTTETEL
- () Fraise carbure, 2 dents, torique, détalonnée
- () MD, 2 TAGLIENTI, SCARICATA, TORICA

- ▶ Due to new coating and new tool geometry, outstanding cutting ability and wear resistance.
- ▶ Excellent for cutting prehardened steels, carbon steels, alloy steels of molds and dies, up to HRC55 and machine parts.
- ▶ Available various products like regular length and long shank end mills etc.
- ▶ Available various corner radius end mills, from min. 0.02mm corner radius to max. 2.0mm corner radius.
- ▶ Available more various effective length and overall length end mills than previous standard products.

- ▶ Aufgrund einer neuartigen Beschichtung und neuer Werkzeuggeometrien hervorragende Schnittleistung und Verschleißfestigkeit
- ▶ Ausgezeichnet geeignet für das Fräsen von vorvergütetem Stahl, kohlenstoff Stahl, legiertem Stahl für Formen, bis HRC55 und Maschinenbauteile.
- ▶ Erhältlich in den Schaft-Ausführungen: standard und lang.
- ▶ Erhältlich in verschiedenen Eckradien-Ausführungen: von 0,02mm bis zu 2,0mm Eckradius.
- ▶ Erhältlich in verschiedenen gesamt Längen und effektiv Längen. Mehr Auswahlmöglichkeiten als bei den bisherigen standard Produkten.

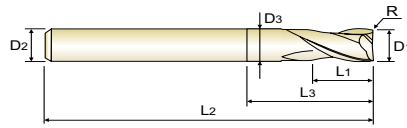

CARBIDE 2 30° ±0.010 ±0.015 PLAIN P.292-299

Unit : mm

EDP No.	Corner Radius	Mill Diameter	Shank Diameter	Length of Cut	Length Below Shank	Overall Length	Neck Diameter	Remark
	R	D1	D2	L1	L3	L2	D3	
SEME6110003100E	R0.3	10.0	10	25	40	100	9.70	Long Shank
★ SEME6110005100E	R0.5	10.0	10	25	40	100	9.70	Long Shank
★ SEME6110010100E	R1.0	10.0	10	25	40	100	9.70	Long Shank
SEME6112002E	R0.2	12.0	12	18	32	80	11.70	Regular
SEME6112003E	R0.3	12.0	12	18	32	80	11.70	Regular
★ SEME6112005E	R0.5	12.0	12	18	32	80	11.70	Regular
★ SEME6112010E	R1.0	12.0	12	18	32	80	11.70	Regular
★ SEME6112015E	R1.5	12.0	12	18	32	80	11.70	Regular
SEME6112020E	R2.0	12.0	12	18	32	80	11.70	Regular
SEME6112003110E	R0.3	12.0	12	30	50	110	11.70	Long Shank
SEME6112005110E	R0.5	12.0	12	30	50	110	11.70	Long Shank
★ SEME6112010110E	R1.0	12.0	12	30	50	110	11.70	Long Shank
★ SEME6116005E	R0.5	16.0	16	20	35	100	15.70	Regular
★ SEME6116010E	R1.0	16.0	16	20	35	100	15.70	Regular
SEME6116005150E	R0.5	16.0	16	35	50	150	15.70	Long Shank
SEME6116010150E	R1.0	16.0	16	35	50	150	15.70	Long Shank
★ SEME6120005E	R0.5	20.0	20	25	40	100	19.70	Regular
★ SEME6120010E	R1.0	20.0	20	25	40	100	19.70	Regular
SEME6120005150E	R0.5	20.0	20	40	55	150	19.70	Long Shank
SEME6120010150E	R1.0	20.0	20	40	55	150	19.70	Long Shank

★ : Stock Item

Size	Corner Radius Tolerance (mm)	Mill Dia. Tolerance (mm)	Shank Dia. Tolerance
up to Ø6	± 0.010	0 ~ - 0.012	h5
over Ø6	± 0.015	0 ~ - 0.015	

◎ : Excellent ○ : Good

ISO Material Description	P										M				K						
	Non-alloy steel					Low alloy steel					High alloyed steel, and tool steel				Stainless steel		Grey cast iron		Nodular cast iron		Malleable cast iron
VDI 3323	1	2	3	4	5	6	7	8	9	10	11	12	13	14	15	16	17	18	19	20	
HRC		13	25	28	32	10	29	32	38	15	35	15	23	10	10	26	3	25	13	21	
HB	125	190	250	270	300	180	275	300	350	200	325	200	240	180	180	260	160	250	130	230	
Recommend	○	○	◎	◎	◎	○	◎	◎	◎	◎	◎	○	○	○	○	○	○	○	○	○	

ISO Material Description	N										S						H				
	Aluminum-wrought alloy		Aluminum-cast, alloyed			Copper and Copper Alloys (Bronze / Brass)			Non Metallic Materials		Heat Resistant Super Alloys						Titanium Alloys		Hardened steel	Chilled Cast Iron	Hardened Cast Iron
VDI 3323	21	22	23	24	25	26	27	28	29	30	31	32	33	34	35	36	37	38	39	40	41
HRC											15	30	25	38	34			55	60	42	55
HB	60	100	75	90	130	110	90	100			200	280	250	350	320	400 Rm	1050 Rm	550	630	400	550
Recommend																		○	◎	○	○

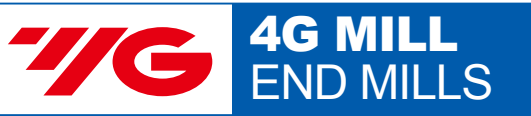

CARBIDE, 4 FLUTE MULTIPLE HELIX CORNER RADIUS (Short, Regular, Long Shank)

- **VOLLHARTMETALL, 4 SCHNEIDEN MEHRSPIRAL ECKENRADIUS**
- **Fraise carbure, 4 dents, torique, hélice multiple**
- **MD, 4 TAGLIENTI, TORICA (Serie corta, media e lunga)**

- ▶ New coating and tool geometry applied resulting outstanding cutting abilities and wear resistance.
- ▶ Excellent performance when cutting prehardened steels, up to HRC55 which are used for molds & dies.
- ▶ Multiple Helix for 3.0mm and over 3.0mm diameter endmills minimizing vibration and decreasing wear in cutting.
- ▶ Available in short, regular and long shank end mills.

- ▶ Aufgrund einer neuartigen Beschichtung und neuer Werkzeuggeometrien hervorragende Schnittleistung und Verschleißfestigkeit
- ▶ Hervorragende Leistung bei der Zerspaltung von vorvergüteten Stählen bis HRC55, welche im Werkzeug- und Formenbau Verwendung finden.
- ▶ Aufgrund der Multi-Helix (M-Helix) bei Schaftfräsern $\geq 3.0\text{mm } \phi$ werden Vibrationen zuverlässig verhindert und gleichzeitig der Schneidkantenverschleiß verringert.
- ▶ Erhältlich in den Schaft-Ausführungen: standard und lang.

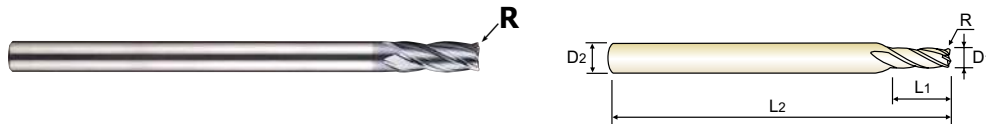

Dϕ3, 30° HELIX

Unit : mm

EDP No.	Corner Radius	Mill Diameter	Shank Diameter	Length of Cut	Overall Length	Remark
	R	D1	D2	L1	L2	
SEME010100054SE	R0.05	1.0	4	2.5	50	4mm Shank
SEME01010014SE	R0.1	1.0	4	2.5	50	4mm Shank
SEME01010024SE	R0.2	1.0	4	2.5	50	4mm Shank
SEME01010034SE	R0.3	1.0	4	2.5	50	4mm Shank
SEME01010005E	R0.05	1.0	6	2.5	50	-
★ SEME0101001E	R0.1	1.0	6	2.5	50	-
SEME0101002E	R0.2	1.0	6	2.5	50	-
SEME0101003E	R0.3	1.0	6	2.5	50	-
SEME010120054SE	R0.05	1.2	4	3	50	4mm Shank
SEME01012014SE	R0.1	1.2	4	3	50	4mm Shank
SEME01012024SE	R0.2	1.2	4	3	50	4mm Shank
SEME01012034SE	R0.3	1.2	4	3	50	4mm Shank
SEME01012005E	R0.05	1.2	6	3	50	-
SEME0101201E	R0.1	1.2	6	3	50	-
SEME0101202E	R0.2	1.2	6	3	50	-
SEME0101203E	R0.3	1.2	6	3	50	-
SEME010150054SE	R0.05	1.5	4	4	50	4mm Shank
SEME01015014SE	R0.1	1.5	4	4	50	4mm Shank
SEME01015024SE	R0.2	1.5	4	4	50	4mm Shank
SEME01015034SE	R0.3	1.5	4	4	50	4mm Shank
SEME01015054SE	R0.5	1.5	4	4	50	4mm Shank
SEME01015005E	R0.05	1.5	6	4	50	-
SEME0101501E	R0.1	1.5	6	4	50	-
SEME0101502E	R0.2	1.5	6	4	50	-

★ : Stock Item

▶ NEXT PAGE

Corner Radius Tolerance (mm)	Mill Dia. Tolerance (mm)	Shank Dia. Tolerance
± 0.02	0 ~ - 0.03	h5

◎ : Excellent ○ : Good

ISO Material Description	P										M			K							
	Non-alloy steel					Low alloy steel					High alloyed steel, and tool steel			Stainless steel			Grey cast iron		Nodular cast iron	Malleable cast iron	
VDI 3323	1	2	3	4	5	6	7	8	9	10	11	12	13	14	15	16	17	18	19	20	
HRc		13	25	28	32	10	29	32	38	15	35	15	23	10	10	26	3	25		21	
HB	125	190	250	270	300	180	275	300	350	200	325	200	240	180	180	260	160	250	130	230	
Recommend	○	○	◎	◎	◎	○	◎	◎	◎	○	◎	○	○	○	○	○	○	○	○	○	
ISO Material Description	N										S							H			
	Aluminum-wrought alloy		Aluminum-cast, alloyed			Copper and Copper Alloys (Bronze / Brass)			Non Metallic Materials		Heat Resistant Super Alloys					Titanium Alloys		Hardened steel	Chilled Cast Iron	Hardened Cast Iron	
VDI 3323	21	22	23	24	25	26	27	28	29	30	31	32	33	34	35	36	37	38	39	40	41
HRc											15	30	25	38	34			55	60	42	55
HB	60	100	75	90	130	110	90	100			200	280	250	350	320	400 Rm	1050 Rm	550	630	400	550
Recommend	○	○	○	○	○	○	○	○	○	○	○	○	○	○	○	○	○	○	○	◎	○

CARBIDE, 4 FLUTE MULTIPLE HELIX CORNER RADIUS (Short, Regular, Long Shank)

- **VOLLHARTMETALL, 4 SCHNEIDEN MEHRSPIRAL ECKENRADIUS**
- (●) **Fraise carbure, 4 dents, torique, hélice multiple**
- (●) **MD, 4 TAGLIENTI, TORICA (Serie corta, media e lunga)**

- ▶ New coating and tool geometry applied resulting outstanding cutting abilities and wear resistance.
- ▶ Excellent performance when cutting prehardened steels, up to HRC55 which are used for molds & dies.
- ▶ Multiple Helix for 3.0mm and over 3.0mm diameter endmills minimizing vibration and decreasing wear in cutting.
- ▶ Available in short, regular and long shank end mills.

- ▶ Aufgrund einer neuartigen Beschichtung und neuer Werkzeuggeometrien hervorragende Schnittleistung und Verschleißfestigkeit
- ▶ Hervorragende Leistung bei der Zerspaltung von vorvergüteten Stählen bis HRC55, welche im Werkzeug- und Formenbau Verwendung finden.
- ▶ Aufgrund der Multi-Helix (M-Helix) bei Schaftfräsern $\geq 3,0\text{mm } \phi$ werden Vibrationen zuverlässig verhindert und gleichzeitig der Schneidkantenverschleiß verringert.
- ▶ Erhältlich in den Schaft-Ausführungen: standard und lang.

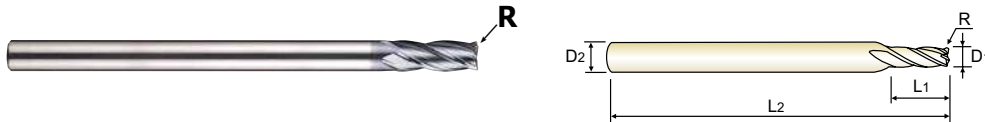

Dϕ3, 30° HELIX

Unit : mm

EDP No.	Corner Radius	Mill Diameter	Shank Diameter	Length of Cut	Overall Length	Remark
	R	D1	D2	L1	L2	
SEME0101503E	R0.3	1.5	6	4	50	-
SEME0101505E	R0.5	1.5	6	4	50	-
SEME01020014SE	R0.1	2.0	4	6	50	4mm Shank
SEME01020024SE	R0.2	2.0	4	6	50	4mm Shank
SEME01020034SE	R0.3	2.0	4	6	50	4mm Shank
SEME01020054SE	R0.5	2.0	4	6	50	4mm Shank
★ SEME0102001E	R0.1	2.0	6	6	50	-
★ SEME0102002E	R0.2	2.0	6	6	50	-
SEME0102003E	R0.3	2.0	6	6	50	-
SEME0102005E	R0.5	2.0	6	6	50	-
SEME01025014SE	R0.1	2.5	4	7	60	4mm Shank
SEME01025024SE	R0.2	2.5	4	7	60	4mm Shank
SEME01025034SE	R0.3	2.5	4	7	60	4mm Shank
SEME01025054SE	R0.5	2.5	4	7	60	4mm Shank
SEME0102501E	R0.1	2.5	6	7	60	-
SEME0102502E	R0.2	2.5	6	7	60	-
SEME0102503E	R0.3	2.5	6	7	60	-
SEME0102505E	R0.5	2.5	6	7	60	-
SEME0103001E	R0.1	3.0	6	8	60	-
★ SEME0103002E	R0.2	3.0	6	8	60	-
★ SEME0103003E	R0.3	3.0	6	8	60	-
★ SEME0103005E	R0.5	3.0	6	8	60	-
SEME0103010E	R1.0	3.0	6	8	60	-
SEME0103501E	R0.1	3.5	6	10	70	-

★ : Stock Item

▶ NEXT PAGE

Corner Radius Tolerance (mm)	Mill Dia. Tolerance (mm)	Shank Dia. Tolerance
± 0.02	0 ~ - 0.03	h5

◎ : Excellent ○ : Good

ISO Material Description	P										M				K							
	Non-alloy steel					Low alloy steel					High alloyed steel, and tool steel				Stainless steel			Grey cast iron		Nodular cast iron		Malleable cast iron
VDI 3323	1	2	3	4	5	6	7	8	9	10	11	12	13	14	15	16	17	18	19	20		
HRC	13	25	28	32	10	29	32	38	15	35	15	23	10	10	26	3	25	13	21			
HB	125	190	250	270	300	180	275	300	350	200	325	200	240	180	180	260	160	250	130	230		
Recommend	○	○	◎	◎	◎	○	◎	◎	◎	◎	◎	◎	◎	◎	◎	○	○	○	○	○	○	

ISO Material Description	N					S					H										
	Aluminum-wrought alloy		Aluminum-cast, alloyed			Copper and Copper Alloys (Bronze / Brass)		Non Metallic Materials			Heat Resistant Super Alloys			Titanium Alloys	Hardened steel	Chilled Cast Iron	Hardened Cast Iron				
VDI 3323	21	22	23	24	25	26	27	28	29	30	31	32	33	34	35	36	37	38	39	40	41
HRC	21	22	23	24	25	26	27	28	29	30	31	32	33	34	35	36	37	55	60	42	55
HB	60	100	75	90	130	110	90	100			200	280	250	350	320	400 Rm	1050 Rm	550	630	400	550
Recommend	○	○	○	○	○	○	○	○	○	○	○	○	○	○	○	○	○	○	○	◎	○

CARBIDE, 4 FLUTE MULTIPLE HELIX CORNER RADIUS (Short, Regular, Long Shank)

● **VOLLHARTMETALL, 4 SCHNEIDEN MEHRSPIRAL ECKENRADIUS**

● **Fraise carbure, 4 dents, torique, hélice multiple**

● **MD, 4 TAGLIANTI, TORICA (Serie corta, media e lunga)**

- ▶ New coating and tool geometry applied resulting outstanding cutting abilities and wear resistance.
- ▶ Excellent performance when cutting prehardened steels, up to HRC55 which are used for molds & dies.
- ▶ Multiple Helix for 3.0mm and over 3.0mm diameter endmills minimizing vibration and decreasing wear in cutting.
- ▶ Available in short, regular and long shank end mills.

- ▶ Aufgrund einer neuartigen Beschichtung und neuer Werkzeuggeometrien hervorragende Schnittleistung und Verschleißfestigkeit
- ▶ Hervorragende Leistung bei der Zerspaltung von vorvergüteten Stählen bis HRC55, welche im Werkzeug- und Formenbau Verwendung finden.
- ▶ Aufgrund der Multi-Helix (M-Helix) bei Schaftfräsern $\geq 3,0\text{mm } \phi$ werden Vibrationen zuverlässig verhindert und gleichzeitig der Schneidkantenverschleiß verringert.
- ▶ Erhältlich in den Schaft-Ausführungen: standard und lang.

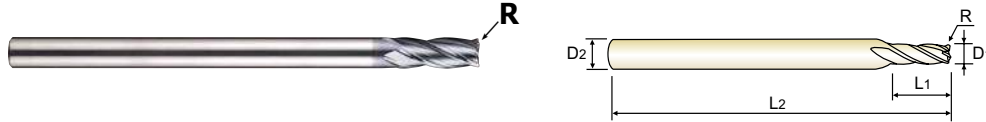

Dϕ3, 30° HELIX

Unit : mm

EDP No.	Corner Radius	Mill Diameter	Shank Diameter	Length of Cut	Overall Length	Remark
	R	D1	D2	L1	L2	
SEME0103502E	R0.2	3.5	6	10	70	-
SEME0103503E	R0.3	3.5	6	10	70	-
SEME0103505E	R0.5	3.5	6	10	70	-
SEME01040014SE	R0.1	4.0	4	10	70	4mm Shank
SEME01040024SE	R0.2	4.0	4	10	70	4mm Shank
SEME01040034SE	R0.3	4.0	4	10	70	4mm Shank
SEME01040054SE	R0.5	4.0	4	10	70	4mm Shank
SEME01040104SE	R1.0	4.0	4	10	70	4mm Shank
SEME01040011004SE	R0.1	4.0	4	10	100	4mm Shank
SEME01040021004SE	R0.2	4.0	4	10	100	4mm Shank
SEME01040031004SE	R0.3	4.0	4	10	100	4mm Shank
SEME01040051004SE	R0.5	4.0	4	10	100	4mm Shank
SEME01040101004SE	R1.0	4.0	4	10	100	4mm Shank
SEME0104001E	R0.1	4.0	6	10	70	Regular
★ SEME0104002E	R0.2	4.0	6	10	70	Regular
★ SEME0104003E	R0.3	4.0	6	10	70	Regular
★ SEME0104005E	R0.5	4.0	6	10	70	Regular
★ SEME0104010E	R1.0	4.0	6	10	70	Regular
SEME0104501E	R0.1	4.5	6	11	80	-
SEME0104502E	R0.2	4.5	6	11	80	-
SEME0104503E	R0.3	4.5	6	11	80	-
SEME0104505E	R0.5	4.5	6	11	80	-
SEME0105001E	R0.1	5.0	6	13	90	-
SEME0105002E	R0.2	5.0	6	13	90	-

★ : Stock Item

▶ NEXT PAGE

Corner Radius Tolerance (mm)	Mill Dia. Tolerance (mm)	Shank Dia. Tolerance
± 0.02	0 ~ - 0.03	h5

◎ : Excellent ○ : Good

ISO Material Description	P										M			K							
	Non-alloy steel					Low alloy steel					High alloyed steel, and tool steel			Stainless steel			Grey cast iron		Nodular cast iron	Malleable cast iron	
VDI 3323	1	2	3	4	5	6	7	8	9	10	11	12	13	14	15	16	17	18	19	20	
HRc		13	25	28	32	10	29	32	38	15	35	15	23	10	10	26	3	25		21	
HB	125	190	250	270	300	180	275	300	350	200	325	200	240	180	180	260	160	250	130	230	
Recommend	○	○	◎	◎	◎	○	◎	◎	◎	○	◎	○	○	○	○	○	○	○	○	○	
ISO Material Description	N										S						H				
	Aluminum-wrought alloy		Aluminum-cast, alloyed			Copper and Copper Alloys (Bronze / Brass)			Non Metallic Materials		Heat Resistant Super Alloys						Titanium Alloys		Hardened steel	Chilled Cast Iron	Hardened Cast Iron
VDI 3323	21	22	23	24	25	26	27	28	29	30	31	32	33	34	35	36	37	38	39	40	41
HRc											15	30	25	38	34			55	60	42	55
HB	60	100	75	90	130	110	90	100			200	280	250	350	320	400 Rm	1050 Rm	550	630	400	550
Recommend	○	○	○	○	○	○	○	○	○	○	○	○	○	○	○	○	○	○	○	○	○



4G MILL END MILLS

PLAIN SHANK

SEME01 SERIES

CARBIDE, 4 FLUTE MULTIPLE HELIX CORNER RADIUS (Short, Regular, Long Shank)

● VOLLHARTMETALL, 4 SCHNEIDEN MEHRSPIRAL ECKENRADIUS

() Fraise carbure, 4 dents, torique, hélice multiple

() MD, 4 TAGLIENTI, TORICA (Serie corta, media e lunga)

- ▶ New coating and tool geometry applied resulting outstanding cutting abilities and wear resistance.
- ▶ Excellent performance when cutting prehardened steels, up to HRC55 which are used for molds & dies.
- ▶ Multiple Helix for 3.0mm and over 3.0mm diameter endmills minimizing vibration and decreasing wear in cutting.
- ▶ Available in short, regular and long shank end mills.

- ▶ Aufgrund einer neuartigen Beschichtung und neuer Werkzeuggeometrien hervorragende Schnittleistung und Verschleißfestigkeit
- ▶ Hervorragende Leistung bei der Zerspaltung von vorvergrüteten Stählen bis HRC55, welche im Werkzeug- und Formenbau Verwendung finden.
- ▶ Aufgrund der Multi-Helix (M-Helix) bei Schaftfräsern $\geq 3,0\text{mm } \phi$ werden Vibrationen zuverlässig verhindert und gleichzeitig der Schneidkantenverschleiß verringert.
- ▶ Erhältlich in den Schaft-Ausführungen: standard und lang.

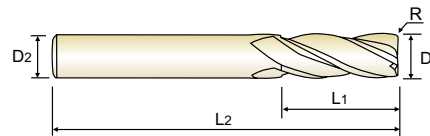

P.300-301

D \leq 3, 30° HELIX

Unit : mm

EDP No.	Corner Radius	Mill Diameter	Shank Diameter	Length of Cut	Overall Length	Remark
	R	D1	D2	L1	L2	
★ SEME0105003E	R0.3	5.0	6	13	90	-
★ SEME0105005E	R0.5	5.0	6	13	90	-
SEME0105010E	R1.0	5.0	6	13	90	-
SEME0105501E	R0.1	5.5	6	13	90	-
SEME0105502E	R0.2	5.5	6	13	90	-
SEME0105503E	R0.3	5.5	6	13	90	-
SEME0105505E	R0.5	5.5	6	13	90	-
SEME0105510E	R1.0	5.5	6	13	90	-
SEME0106001060E	R0.1	6.0	6	15	60	Short
SEME0106002060E	R0.2	6.0	6	15	60	Short
SEME0106001E	R0.1	6.0	6	15	90	Regular
★ SEME0106002E	R0.2	6.0	6	15	90	Regular
★ SEME0106003E	R0.3	6.0	6	15	90	Regular
★ SEME0106005E	R0.5	6.0	6	15	90	Regular
★ SEME0106010E	R1.0	6.0	6	15	90	Regular
SEME0106015E	R1.5	6.0	6	15	90	Regular
SEME0106020E	R2.0	6.0	6	15	90	Regular
SEME0106005110E	R0.5	6.0	6	15	110	Long Shank
SEME0106010110E	R1.0	6.0	6	15	110	Long Shank
SEME0106005130E	R0.5	6.0	6	15	130	Long Shank
SEME0106010130E	R1.0	6.0	6	15	130	Long Shank
SEME0107001E	R0.1	7.0	8	16	90	-
SEME0107002E	R0.2	7.0	8	16	90	-
SEME0107003E	R0.3	7.0	8	16	90	-

★ : Stock Item

▶ NEXT PAGE

Corner Radius Tolerance (mm)	Mill Dia. Tolerance (mm)	Shank Dia. Tolerance
± 0.02	0 ~ - 0.03	h5

◎ : Excellent ○ : Good

ISO Material Description	P										M				K						
	Non-alloy steel					Low alloy steel					High alloyed steel, and tool steel				Stainless steel		Grey cast iron		Nodular cast iron		Malleable cast iron
VDI 3323	1	2	3	4	5	6	7	8	9	10	11	12	13	14	15	16	17	18	19	20	
HRC	13	25	28	32	10	29	32	38	15	35	15	23	10	10	26	3	25	130	21		
HB	125	190	250	270	300	180	275	300	350	200	325	200	240	180	180	260	160	250	130	230	
Recommend	○	○	◎	◎	◎	○	◎	◎	◎	◎	◎	◎	◎	◎	○	○	○	○	○	○	
ISO Material Description	N										S						H				
	Aluminum-wrought alloy		Aluminum-cast, alloyed			Copper and Copper Alloys (Bronze / Brass)			Non Metallic Materials		Heat Resistant Super Alloys						Titanium Alloys		Hardened steel	Chilled Cast Iron	Hardened Cast Iron
VDI 3323	21	22	23	24	25	26	27	28	29	30	31	32	33	34	35	36	37	38	39	40	41
HRC	21	22	23	24	25	26	27	28	29	30	31	32	33	34	35	36	37	55	60	42	55
HB	60	100	75	90	130	110	90	100			200	280	250	350	320	400 Rm	1050 Rm	550	630	400	550
Recommend																		○	◎	◎	○

YG 4G MILL END MILLS

PLAIN SHANK

SEME01 SERIES

CARBIDE, 4 FLUTE MULTIPLE HELIX CORNER RADIUS (Short, Regular, Long Shank)

● **VOLLHARTMETALL, 4 SCHNEIDEN MEHRSPIRAL ECKENRADIUS**

● **Fraise carbure, 4 dents, torique, hélice multiple**

● **VMD, 4 TAGLIENTI, TORICA (Serie corta, media e lunga)**

- ▶ New coating and tool geometry applied resulting outstanding cutting abilities and wear resistance.
- ▶ Excellent performance when cutting prehardened steels, up to HRC55 which are used for molds & dies.
- ▶ Multiple Helix for 3.0mm and over 3.0mm diameter endmills minimizing vibration and decreasing wear in cutting.
- ▶ Available in short, regular and long shank end mills.

- ▶ Aufgrund einer neuartigen Beschichtung und neuer Werkzeuggeometrien hervorragende Schnittleistung und Verschleißfestigkeit
- ▶ Hervorragende Leistung bei der Zerspaltung von vorvergüteten Stählen bis HRC55, welche im Werkzeug- und Formenbau Verwendung finden.
- ▶ Aufgrund der Multi-Helix (M-Helix) bei Schaftfräsern $\geq 3,0\text{mm } \phi$ werden Vibrationen zuverlässig verhindert und gleichzeitig der Schneidkantenverschleiß verringert.
- ▶ Erhältlich in den Schaft-Ausführungen: standard und lang.

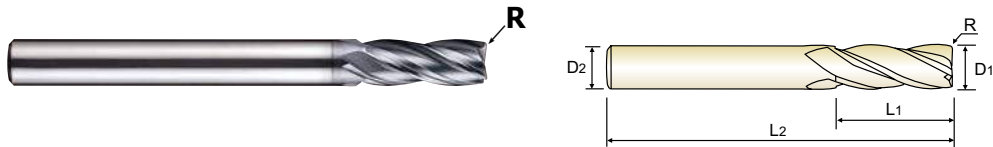

Dϕ3, 30° HELIX

Unit : mm

EDP No.	Corner Radius	Mill Diameter	Shank Diameter	Length of Cut	Overall Length	Remark
	R	D1	D2	L1	L2	
SEME0107005E	R0.5	7.0	8	16	90	-
SEME0107010E	R1.0	7.0	8	16	90	-
SEME0107020E	R2.0	7.0	8	16	90	-
★ SEME0108003070E	R0.3	8.0	8	20	70	Short
★ SEME0108005070E	R0.5	8.0	8	20	70	Short
★ SEME0108010070E	R1.0	8.0	8	20	70	Short
SEME0108001E	R0.1	8.0	8	20	100	Regular
★ SEME0108002E	R0.2	8.0	8	20	100	Regular
★ SEME0108003E	R0.3	8.0	8	20	100	Regular
★ SEME0108005E	R0.5	8.0	8	20	100	Regular
★ SEME0108010E	R1.0	8.0	8	20	100	Regular
★ SEME0108015E	R1.5	8.0	8	20	100	Regular
★ SEME0108020E	R2.0	8.0	8	20	100	Regular
SEME0108025E	R2.5	8.0	8	20	100	Regular
SEME0108030E	R3.0	8.0	8	20	100	Regular
SEME0108005120E	R0.5	8.0	8	20	120	Long Shank
SEME0108010120E	R1.0	8.0	8	20	120	Long Shank
SEME0108005150E	R0.5	8.0	8	20	150	Long Shank
SEME0108010150E	R1.0	8.0	8	20	150	Long Shank
SEME0110003075E	R0.3	10.0	10	25	75	Short
SEME0110005075E	R0.5	10.0	10	25	75	Short
SEME0110010075E	R1.0	10.0	10	25	75	Short
SEME0110001E	R0.1	10.0	10	25	100	Regular
SEME0110002E	R0.2	10.0	10	25	100	Regular

★ : Stock Item

▶ NEXT PAGE

Corner Radius Tolerance (mm)	Mill Dia. Tolerance (mm)	Shank Dia. Tolerance
± 0.02	0 ~ - 0.03	h5

◎ : Excellent ○ : Good

ISO Material Description	P										M				K								
	Non-alloy steel					Low alloy steel					High alloyed steel, and tool steel				Stainless steel		Grey cast iron		Nodular cast iron		Malleable cast iron		
VDI 3323	1	2	3	4	5	6	7	8	9	10	11	12	13	14	15	16	17	18	19	20			
HRc		13	25	28	32	10	29	32	38	15	35	15	23	10	10	26	3	25		21			
HB	125	190	250	270	300	180	275	300	350	200	325	200	240	180	180	260	160	250	130	230			
Recommend	○	○	◎	◎	◎	○	◎	◎	◎	○	◎	○	○	○	○	○	○	○	○	○			
ISO Material Description	N										S						H						
	Aluminum-wrought alloy		Aluminum-cast, alloyed			Copper and Copper Alloys (Bronze / Brass)			Non Metallic Materials		Heat Resistant Super Alloys						Titanium Alloys		Hardened steel		Chilled Cast Iron		Hardened Cast Iron
VDI 3323	21	22	23	24	25	26	27	28	29	30	31	32	33	34	35	36	37	38	39	40	41		
HRc											15	30	25	38	34			55	60	42	55		
HB	60	100	75	90	130	110	90	100			200	280	250	350	320	400 Rm	1050 Rm	550	630	400	550		
Recommend											○	○	○	○	○	○	○	○	○	◎	◎		

YG 4G MILL END MILLS

PLAIN SHANK **SEME01** SERIES

CARBIDE, 4 FLUTE MULTIPLE HELIX CORNER RADIUS (Short, Regular, Long Shank)

- VOLLHARTMETALL, 4 SCHNEIDEN MEHRSPIRAL ECKENRADIUS
- Fraise carbure, 4 dents, torique, hélice multiple
- VMD, 4 TAGLIENTI, TORICA (Serie corta, media e lunga)

- ▶ New coating and tool geometry applied resulting outstanding cutting abilities and wear resistance.
- ▶ Excellent performance when cutting prehardened steels, up to HRC55 which are used for molds & dies.
- ▶ Multiple Helix for 3.0mm and over 3.0mm diameter endmills minimizing vibration and decreasing wear in cutting.
- ▶ Available in short, regular and long shank end mills.

- ▶ Aufgrund einer neuartigen Beschichtung und neuer Werkzeuggeometrien hervorragende Schnittleistung und Verschleißfestigkeit
- ▶ Hervorragende Leistung bei der Zerspaltung von vorvergüteten Stählen bis HRC55, welche im Werkzeug- und Formenbau Verwendung finden.
- ▶ Aufgrund der Multi-Helix (M-Helix) bei Schaftfräsern $\geq 3,0\text{mm } \phi$ werden Vibrationen zuverlässig verhindert und gleichzeitig der Schneidkantenverschleiß verringert.
- ▶ Erhältlich in den Schaft-Ausführungen: standard und lang.

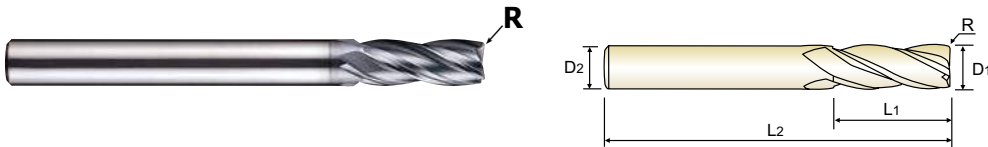

CARBIDE 4 27°/30° ±0.02 PLAIN P.300-301

Dϕ3, 30° HELIX

Unit : mm

EDP No.	Corner Radius	Mill Diameter	Shank Diameter	Length of Cut	Overall Length	Remark
	R	D1	D2	L1	L2	
SEME0110003E	R0.3	10.0	10	25	100	Regular
SEME0110005E	R0.5	10.0	10	25	100	Regular
★ SEME0110010E	R1.0	10.0	10	25	100	Regular
★ SEME0110015E	R1.5	10.0	10	25	100	Regular
★ SEME0110020E	R2.0	10.0	10	25	100	Regular
★ SEME0110025E	R2.5	10.0	10	25	100	Regular
SEME0110030E	R3.0	10.0	10	25	100	Regular
SEME0110040E	R4.0	10.0	10	25	100	Regular
SEME0110005130E	R0.5	10.0	10	22	130	Long Shank
SEME0110010130E	R1.0	10.0	10	22	130	Long Shank
SEME0110005150E	R0.5	10.0	10	22	150	Long Shank
SEME0110010150E	R1.0	10.0	10	22	150	Long Shank
★ SEME0111002E	R0.2	11.0	12	25	110	-
★ SEME0111003E	R0.3	11.0	12	25	110	-
SEME0111005E	R0.5	11.0	12	25	110	-
SEME0111010E	R1.0	11.0	12	25	110	-
SEME0111020E	R2.0	11.0	12	25	110	-
SEME0112003080E	R0.3	12.0	12	30	80	Short
SEME0112005080E	R0.5	12.0	12	30	80	Short
SEME0112010080E	R1.0	12.0	12	30	80	Short
SEME0112001E	R0.1	12.0	12	30	110	Regular
SEME0112002E	R0.2	12.0	12	30	110	Regular
SEME0112003E	R0.3	12.0	12	30	110	Regular
★ SEME0112005E	R0.5	12.0	12	30	110	Regular

★ : Stock Item

▶ NEXT PAGE

Corner Radius Tolerance (mm)	Mill Dia. Tolerance (mm)	Shank Dia. Tolerance
± 0.02	0 ~ - 0.03	h5

◎ : Excellent ○ : Good

ISO Material Description	P										M				K						
	Non-alloy steel					Low alloy steel					High alloyed steel, and tool steel				Stainless steel		Grey cast iron		Nodular cast iron		Malleable cast iron
VDI 3323	1	2	3	4	5	6	7	8	9	10	11	12	13	14	15	16	17	18	19	20	
HRC	13	25	28	32	10	29	32	38	15	35	15	23	10	10	26	3	25	130	21		
HB	125	190	250	270	300	180	275	300	350	200	325	200	240	180	180	260	160	250	130	230	
Recommend	○	○	◎	◎	◎	○	◎	◎	◎	◎	◎	◎	◎	○	○	○	○	○	○	○	○

ISO Material Description	N					S										H						
	Aluminum-wrought alloy		Aluminum-cast, alloyed			Copper and Copper Alloys (Bronze / Brass)			Non Metallic Materials		Heat Resistant Super Alloys					Titanium Alloys		Hardened steel	Chilled Cast Iron	Hardened Cast Iron		
VDI 3323	21	22	23	24	25	26	27	28	29	30	31	32	33	34	35	36	37	38	39	40	41	
HRC	60	100	75	90	130	110	90	100	15	30	25	38	34	15	30	25	38	34	55	60	42	55
HB	60	100	75	90	130	110	90	100	200	280	250	350	320	400 Rm	1050 Rm	550	630	400	550			
Recommend	○	○	○	○	○	○	○	○	○	○	○	○	○	○	○	○	○	○	◎	○	○	

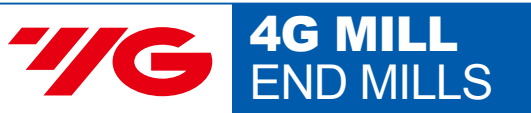

CARBIDE, 4 FLUTE MULTIPLE HELIX CORNER RADIUS (Short, Regular, Long Shank)

● **VOLLHARTMETALL, 4 SCHNEIDEN MEHRSPIRAL ECKENRADIUS**

● **Fraise carbure, 4 dents, torique, hélice multiple**

● **VMD, 4 TAGLIENTI, TORICA (Serie corta, media e lunga)**

- ▶ New coating and tool geometry applied resulting outstanding cutting abilities and wear resistance.
- ▶ Excellent performance when cutting prehardened steels, up to HRC55 which are used for molds & dies.
- ▶ Multiple Helix for 3.0mm and over 3.0mm diameter endmills minimizing vibration and decreasing wear in cutting.
- ▶ Available in short, regular and long shank end mills.

- ▶ Aufgrund einer neuartigen Beschichtung und neuer Werkzeuggeometrien hervorragende Schnittleistung und Verschleißfestigkeit
- ▶ Hervorragende Leistung bei der Zerspaltung von vorvergüteten Stählen bis HRC55, welche im Werkzeug- und Formenbau Verwendung finden.
- ▶ Aufgrund der Multi-Helix (M-Helix) bei Schaftfräsern $\geq 3,0\text{mm } \phi$ werden Vibrationen zuverlässig verhindert und gleichzeitig der Schneidkantenverschleiß verringert.
- ▶ Erhältlich in den Schaft-Ausführungen: standard und lang.

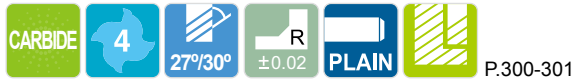
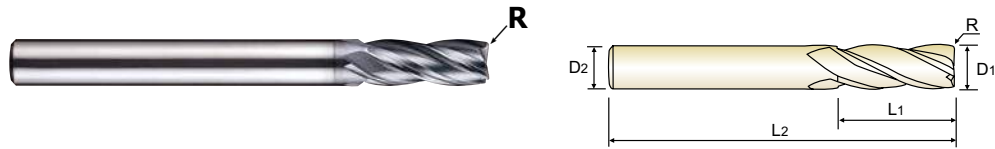

Dϕ3, 30° HELIX

Unit : mm

EDP No.	Corner Radius	Mill Diameter	Shank Diameter	Length of Cut	Overall Length	Remark
	R	D1	D2	L1	L2	
★ SEME0112010E	R1.0	12.0	12	30	110	Regular
★ SEME0112015E	R1.5	12.0	12	30	110	Regular
★ SEME0112020E	R2.0	12.0	12	30	110	Regular
SEME0112025E	R2.5	12.0	12	30	110	Regular
SEME0112030E	R3.0	12.0	12	30	110	Regular
SEME0112040E	R4.0	12.0	12	30	110	Regular
SEME0112050E	R5.0	12.0	12	30	110	Regular
SEME0112005130E	R0.5	12.0	12	30	130	Long Shank
SEME0112010130E	R1.0	12.0	12	30	130	Long Shank
SEME0112005150E	R0.5	12.0	12	30	130	Long Shank
SEME0112010150E	R1.0	12.0	12	30	130	Long Shank
SEME0114005E	R0.5	14.0	16	35	150	-
SEME0114010E	R1.0	14.0	16	35	150	-
SEME0114020E	R2.0	14.0	16	35	150	-
★ SEME0116005E	R0.5	16.0	16	32	150	-
★ SEME0116010E	R1.0	16.0	16	32	150	-
★ SEME0116015E	R1.5	16.0	16	32	150	-
★ SEME0116020E	R2.0	16.0	16	32	150	-
SEME0120005E	R0.5	20.0	20	38	150	-
★ SEME0120010E	R1.0	20.0	20	38	150	-
SEME0120015E	R1.5	20.0	20	38	150	-
★ SEME0120020E	R2.0	20.0	20	38	150	-

★ : Stock Item

Corner Radius Tolerance (mm)	Mill Dia. Tolerance (mm)	Shank Dia. Tolerance
± 0.02	0 ~ - 0.03	h5

◎ : Excellent ○ : Good

ISO Material Description	P										M				K							
	Non-alloy steel					Low alloy steel					High alloyed steel, and tool steel				Stainless steel				Grey cast iron		Nodular cast iron	
VDI 3323	1	2	3	4	5	6	7	8	9	10	11	12	13	14	15	16	17	18	19	20		
HRc		13	25	28	32	10	29	32	38	15	35	15	23	10	10	26	3	25		21		
HB	125	190	250	270	300	180	275	300	350	200	325	200	240	180	180	260	160	250	130	230		
Recommend	○	○	◎	◎	◎	◎	◎	◎	◎	○	◎	○	○	○	○	○	○	○	○	○		
ISO Material Description	N										S							H				
	Aluminum-wrought alloy		Aluminum-cast, alloyed			Copper and Copper Alloys (Bronze / Brass)			Non Metallic Materials		Heat Resistant Super Alloys					Titanium Alloys		Hardened steel	Chilled Cast Iron	Hardened Cast Iron		
VDI 3323	21	22	23	24	25	26	27	28	29	30	31	32	33	34	35	36	37	38	39	40	41	
HRc											15	30	25	38	34			55	60	42	55	
HB	60	100	75	90	130	110	90	100			200	280	250	350	320	400 Rm	1050 Rm	550	630	400	550	
Recommend	○	○	○	○	○	○	○	○	○	○	○	○	○	○	○	○	○	○	○	○	○	

CARBIDE, 4 FLUTE MULTIPLE HELIX CORNER RADIUS with EXTENDED NECK

● **VOLLHARTMETALL, 4 SCHNEIDEN MEHRSPIRAL ECKENRADIUS mit ABGESETZTEM SCHAFTTETEL**
 (●) **Fraise carbure, 4 dents, torique, hélice multiple, détalonnée**
 (●) **MD, 4 TAGLIENTI, SCARICATA, TORICA**

- ▶ New coating and tool geometry applied resulting outstanding cutting abilities and wear resistance.
- ▶ Excellent performance when cutting prehardened steels, up to HRC55 which are used for molds & dies.
- ▶ Multiple Helix for 3.0mm and over 3.0mm diameter endmills minimizing vibration and decreasing wear in cutting.

- ▶ Aufgrund einer neuartigen Beschichtung und neuer Werkzeuggeometrien hervorragende Schnittleistung und Verschleißfestigkeit
- ▶ Hervorragende Leistung bei der Zerspaltung von vorvergüteten Stählen bis HRC55, welche im Werkzeug- und Formenbau Verwendung finden.
- ▶ Aufgrund der Multi-Helix (M-Helix) bei Schaftfräsern ≥ 3,0mm ø werden Vibrationen zuverlässig verhindert und gleichzeitig der Schneidkantenverschleiß verringert.

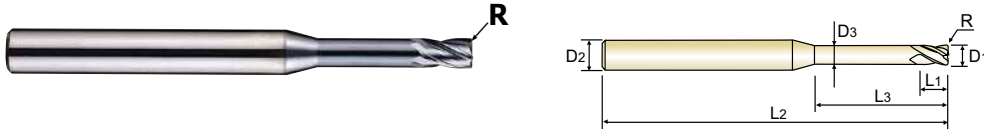

D<Ø3, 30° HELIX

Unit : mm

EDP No.	Corner Radius	Mill Diameter	Shank Diameter	Length of Cut	Length Below Shank	Overall Length	Neck Diameter	Remark
	R	D1	D2	L1	L3	L2	D3	
SEME6401000503E	R0.05	1.0	4	1.5	3	50	0.95	-
SEME6401000504E	R0.05	1.0	4	1.5	4	50	0.95	-
SEME6401000506E	R0.05	1.0	4	1.5	6	50	0.95	-
SEME6401000508E	R0.05	1.0	4	1.5	8	50	0.95	-
SEME6401000510E	R0.05	1.0	4	1.5	10	50	0.95	-
SEME6401000512E	R0.05	1.0	4	1.5	12	50	0.95	-
SEME6401000514E	R0.05	1.0	4	1.5	14	50	0.95	-
SEME6401000516E	R0.05	1.0	4	1.5	16	50	0.95	-
SEME6401000520E	R0.05	1.0	4	1.5	20	50	0.95	-
SEME640100103E	R0.1	1.0	4	1.5	3	50	0.95	-
★ SEME640100104E	R0.1	1.0	4	1.5	4	50	0.95	-
★ SEME640100106E	R0.1	1.0	4	1.5	6	50	0.95	-
★ SEME640100108E	R0.1	1.0	4	1.5	8	50	0.95	-
SEME640100110E	R0.1	1.0	4	1.5	10	50	0.95	-
SEME640100112E	R0.1	1.0	4	1.5	12	50	0.95	-
SEME640100114E	R0.1	1.0	4	1.5	14	50	0.95	-
SEME640100116E	R0.1	1.0	4	1.5	16	50	0.95	-
SEME640100120E	R0.1	1.0	4	1.5	20	50	0.95	-
SEME640100203E	R0.2	1.0	4	1.5	3	50	0.95	-
★ SEME640100204E	R0.2	1.0	4	1.5	4	50	0.95	-
★ SEME640100206E	R0.2	1.0	4	1.5	6	50	0.95	-
★ SEME640100208E	R0.2	1.0	4	1.5	8	50	0.95	-
★ SEME640100210E	R0.2	1.0	4	1.5	10	50	0.95	-
SEME640100212E	R0.2	1.0	4	1.5	12	50	0.95	-

★ : Stock Item

▶ NEXT PAGE

Corner Radius Tolerance (mm)	Mill Dia. Tolerance (mm)	Shank Dia. Tolerance
± 0.02	0 ~ - 0.03	h5

◎ : Excellent ○ : Good

ISO Material Description	P										M				K						
	Non-alloy steel					Low alloy steel					High alloyed steel, and tool steel				Stainless steel		Grey cast iron		Nodular cast iron		Malleable cast iron
VDI 3323	1	2	3	4	5	6	7	8	9	10	11	12	13	14	15	16	17	18	19	20	
HRC	13	25	28	32	10	29	32	38	15	35	15	23	10	10	26	3	25	13	21		
HB	125	190	250	270	300	180	275	300	350	200	325	200	240	180	180	260	160	250	130	230	
Recommend	○	◎	◎	◎	◎	○	◎	◎	◎	◎	◎	◎	◎	◎	◎	○	○	○	○	○	○

ISO Material Description	N										S						H				
	Aluminum-wrought alloy		Aluminum-cast, alloyed			Copper and Copper Alloys (Bronze / Brass)			Non Metallic Materials		Heat Resistant Super Alloys						Titanium Alloys		Hardened steel	Chilled Cast Iron	Hardened Cast Iron
VDI 3323	21	22	23	24	25	26	27	28	29	30	31	32	33	34	35	36	37	38	39	40	41
HRC	21	22	23	24	25	26	27	28	29	30	31	32	33	34	35	36	37	38	39	40	41
HB	60	100	75	90	130	110	90	100			200	280	250	350	320	400 Rm	1050 Rm	550	630	400	550
Recommend																		○	◎	◎	○

YG 4G MILL END MILLS

PLAIN SHANK

SEME64 SERIES

CARBIDE, 4 FLUTE MULTIPLE HELIX CORNER RADIUS with EXTENDED NECK

- **VOLLHARTMETALL, 4 SCHNEIDEN MEHRSPIRAL ECKENRADIUS mit ABGESETZTEM SCHAFTTETL**
- **Fraise carbure, 4 dents, torique, hélice multiple, détalonnée**
- **MD, 4 TAGLIANTI, SCARICATA, TORICA**

- ▶ New coating and tool geometry applied resulting outstanding cutting abilities and wear resistance.
- ▶ Excellent performance when cutting prehardened steels, up to HRC55 which are used for molds & dies.
- ▶ Multiple Helix for 3.0mm and over 3.0mm diameter endmills minimizing vibration and decreasing wear in cutting.

- ▶ Aufgrund einer neuartigen Beschichtung und neuer Werkzeuggeometrien hervorragende Schnittleistung und Verschleißfestigkeit
- ▶ Hervorragende Leistung bei der Zerspaltung von vorvergüteten Stählen bis HRC55, welche im Werkzeug- und Formenbau Verwendung finden.
- ▶ Aufgrund der Multi-Helix (M-Helix) bei Schaftfräsern $\geq 3,0\text{mm } \phi$ werden Vibrationen zuverlässig verhindert und gleichzeitig der Schneidkantenverschleiß verringert.

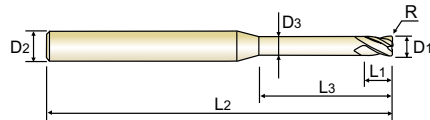

CARBIDE
4
27°/30°
±0.02
PLAIN
P.302-305

Dϕ3, 30° HELIX

Unit : mm

EDP No.	Corner Radius	Mill Diameter	Shank Diameter	Length of Cut	Length Below Shank	Overall Length	Neck Diameter	Remark
	R	D1	D2	L1	L3	L2	D3	
SEME640100214E	R0.2	1.0	4	1.5	14	50	0.95	-
SEME640100216E	R0.2	1.0	4	1.5	16	50	0.95	-
SEME640100220E	R0.2	1.0	4	1.5	20	50	0.95	-
SEME640100303E	R0.3	1.0	4	1.5	3	50	0.95	-
★ SEME640100304E	R0.3	1.0	4	1.5	4	50	0.95	-
★ SEME640100306E	R0.3	1.0	4	1.5	6	50	0.95	-
★ SEME640100308E	R0.3	1.0	4	1.5	8	50	0.95	-
SEME640100310E	R0.3	1.0	4	1.5	10	50	0.95	-
SEME640100312E	R0.3	1.0	4	1.5	12	50	0.95	-
SEME640100314E	R0.3	1.0	4	1.5	14	50	0.95	-
SEME640100316E	R0.3	1.0	4	1.5	16	50	0.95	-
SEME640100320E	R0.3	1.0	4	1.5	20	50	0.95	-
SEME6401200503E	R0.05	1.2	4	1.8	3	50	1.15	-
SEME6401200504E	R0.05	1.2	4	1.8	4	50	1.15	-
SEME6401200506E	R0.05	1.2	4	1.8	6	50	1.15	-
SEME6401200508E	R0.05	1.2	4	1.8	8	50	1.15	-
SEME6401200510E	R0.05	1.2	4	1.8	10	50	1.15	-
SEME6401200512E	R0.05	1.2	4	1.8	12	50	1.15	-
SEME6401200516E	R0.05	1.2	4	1.8	16	50	1.15	-
SEME6401200520E	R0.05	1.2	4	1.8	20	50	1.15	-
SEME640120103E	R0.1	1.2	4	1.8	3	50	1.15	-
★ SEME640120104E	R0.1	1.2	4	1.8	4	50	1.15	-
★ SEME640120106E	R0.1	1.2	4	1.8	6	50	1.15	-
★ SEME640120108E	R0.1	1.2	4	1.8	8	50	1.15	-

★ : Stock Item

▶ NEXT PAGE

Corner Radius Tolerance (mm)	Mill Dia. Tolerance (mm)	Shank Dia. Tolerance
± 0.02	0 ~ - 0.03	h5

◎ : Excellent ○ : Good

ISO Material Description	P										M			K							
	Non-alloy steel					Low alloy steel					High alloyed steel, and tool steel			Stainless steel			Grey cast iron		Nodular cast iron		Malleable cast iron
VDI 3323	1	2	3	4	5	6	7	8	9	10	11	12	13	14	15	16	17	18	19	20	
HRc		13	25	28	32	10	29	32	38	15	35	15	23	10	10	26	3	25		21	
HB	125	190	250	270	300	180	275	300	350	200	325	200	240	180	180	260	160	250	130	230	
Recommend	○	◎	◎	◎	◎	○	◎	◎	◎	○	◎	○	○	○	○	○	○	○	○	○	
ISO Material Description	N										S							H			
	Aluminum-wrought alloy		Aluminum-cast, alloyed			Copper and Copper Alloys (Bronze / Brass)			Non Metallic Materials		Heat Resistant Super Alloys					Titanium Alloys		Hardened steel	Chilled Cast Iron	Hardened Cast Iron	
VDI 3323	21	22	23	24	25	26	27	28	29	30	31	32	33	34	35	36	37	38	39	40	41
HRc											15	30	25	38	34			55	60	42	55
HB	60	100	75	90	130	110	90	100			200	280	250	350	320	400 Rm	1050 Rm	550	630	400	550
Recommend																		◎	◎	◎	○

CARBIDE, 4 FLUTE MULTIPLE HELIX CORNER RADIUS with EXTENDED NECK

- VOLLHARTMETALL, 4 SCHNEIDEN MEHRSPIRAL ECKENRADIUS mit ABGESETZTEM SCHAFTTETEL
- Fraise carbure, 4 dents, torique, hélice multiple, détalonnée
- MD, 4 TAGLIENTI, SCARICATA, TORICA

- ▶ New coating and tool geometry applied resulting outstanding cutting abilities and wear resistance.
- ▶ Excellent performance when cutting prehardened steels, up to HRC55 which are used for molds & dies.
- ▶ Multiple Helix for 3.0mm and over 3.0mm diameter endmills minimizing vibration and decreasing wear in cutting.

- ▶ Aufgrund einer neuartigen Beschichtung und neuer Werkzeuggeometrien hervorragende Schnittleistung und Verschleißfestigkeit
- ▶ Hervorragende Leistung bei der Zerspaltung von vorvergüteten Stählen bis HRC55, welche im Werkzeug- und Formenbau Verwendung finden.
- ▶ Aufgrund der Multi-Helix (M-Helix) bei Schaftfräsern ≥ 3,0mm ø werden Vibrationen zuverlässig verhindert und gleichzeitig der Schneidkantenverschleiß verringert.

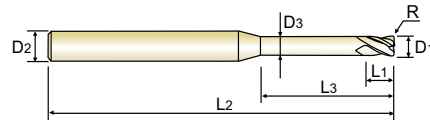

CARBIDE 4 27°/30° ±0.02 PLAIN P.302-305

D<03, 30° HELIX

Unit : mm

EDP No.	Corner Radius	Mill Diameter	Shank Diameter	Length of Cut	Length Below Shank	Overall Length	Neck Diameter	Remark
	R	D1	D2	L1	L3	L2	D3	
SEME640120110E	R0.1	1.2	4	1.8	10	50	1.15	-
SEME640120112E	R0.1	1.2	4	1.8	12	50	1.15	-
SEME640120116E	R0.1	1.2	4	1.8	16	50	1.15	-
SEME640120120E	R0.1	1.2	4	1.8	20	50	1.15	-
SEME640120203E	R0.2	1.2	4	1.8	3	50	1.15	-
★ SEME640120204E	R0.2	1.2	4	1.8	4	50	1.15	-
★ SEME640120206E	R0.2	1.2	4	1.8	6	50	1.15	-
★ SEME640120208E	R0.2	1.2	4	1.8	8	50	1.15	-
SEME640120210E	R0.2	1.2	4	1.8	10	50	1.15	-
SEME640120212E	R0.2	1.2	4	1.8	12	50	1.15	-
SEME640120216E	R0.2	1.2	4	1.8	16	50	1.15	-
SEME640120220E	R0.2	1.2	4	1.8	20	50	1.15	-
SEME640120303E	R0.3	1.2	4	1.8	3	50	1.15	-
★ SEME640120304E	R0.3	1.2	4	1.8	4	50	1.15	-
★ SEME640120306E	R0.3	1.2	4	1.8	6	50	1.15	-
★ SEME640120308E	R0.3	1.2	4	1.8	8	50	1.15	-
SEME640120310E	R0.3	1.2	4	1.8	10	50	1.15	-
SEME640120312E	R0.3	1.2	4	1.8	12	50	1.15	-
SEME640120316E	R0.3	1.2	4	1.8	16	50	1.15	-
SEME640120320E	R0.3	1.2	4	1.8	20	50	1.15	-
SEME6401500504E	R0.05	1.5	4	2.3	4	50	1.45	-
SEME6401500506E	R0.05	1.5	4	2.3	6	50	1.45	-
SEME6401500508E	R0.05	1.5	4	2.3	8	50	1.45	-
SEME6401500510E	R0.05	1.5	4	2.3	10	50	1.45	-

★ : Stock Item

▶ NEXT PAGE

Corner Radius Tolerance (mm)	Mill Dia. Tolerance (mm)	Shank Dia. Tolerance
± 0.02	0 ~ - 0.03	h5

◎ : Excellent ○ : Good

ISO Material Description	P										M				K						
	Non-alloy steel					Low alloy steel					High alloyed steel, and tool steel				Stainless steel		Grey cast iron		Nodular cast iron		Malleable cast iron
VDI 3323	1	2	3	4	5	6	7	8	9	10	11	12	13	14	15	16	17	18	19	20	
HRC	13	25	28	32	10	29	32	38	15	35	15	23	10	10	26	3	25	13	21		
HB	125	190	250	270	300	180	275	300	350	200	325	200	240	180	180	260	160	250	130	230	
Recommend	○	◎	◎	◎	◎	○	◎	◎	◎	◎	◎	◎	◎	◎	◎	○	○	○	○	○	○

ISO Material Description	N					S					H										
	Aluminum-wrought alloy		Aluminum-cast, alloyed			Copper and Copper Alloys (Bronze / Brass)		Non Metallic Materials			Heat Resistant Super Alloys			Titanium Alloys	Hardened steel	Chilled Cast Iron	Hardened Cast Iron				
VDI 3323	21	22	23	24	25	26	27	28	29	30	31	32	33	34	35	36	37	38	39	40	41
HRC	15	30	25	38	34	15	30	25	38	34	15	30	25	38	34	55	60	55	60	42	55
HB	60	100	75	90	130	110	90	100			200	280	250	350	320	400 Rm	1050 Rm	550	630	400	550
Recommend																		○	◎	◎	○

YG 4G MILL END MILLS

PLAIN SHANK **SEME64** SERIES

CARBIDE, 4 FLUTE MULTIPLE HELIX CORNER RADIUS with EXTENDED NECK

🇩🇪 **VOLLHARTMETALL, 4 SCHNEIDEN MEHRSPIRAL ECKENRADIUS mit ABGESETZTEM SCHAFTTETL**
🇫🇷 **Fraise carbure, 4 dents, torique, hélice multiple, détalonnée**
🇮🇹 **MD, 4 TAGLIANTI, SCARICATA, TORICA**

- ▶ New coating and tool geometry applied resulting outstanding cutting abilities and wear resistance.
 - ▶ Excellent performance when cutting prehardened steels, up to HRC55 which are used for molds & dies.
 - ▶ Multiple Helix for 3.0mm and over 3.0mm diameter endmills minimizing vibration and decreasing wear in cutting.
- ▶ Aufgrund einer neuartigen Beschichtung und neuer Werkzeuggeometrien hervorragende Schnittleistung und Verschleißfestigkeit
 - ▶ Hervorragende Leistung bei der Zerspaltung von vorvergüteten Stählen bis HRC55, welche im Werkzeug- und Formenbau Verwendung finden.
 - ▶ Aufgrund der Multi-Helix (M-Helix) bei Schaftfräsern $\geq 3,0\text{mm } \phi$ werden Vibrationen zuverlässig verhindert und gleichzeitig der Schneidkantenverschleiß verringert.

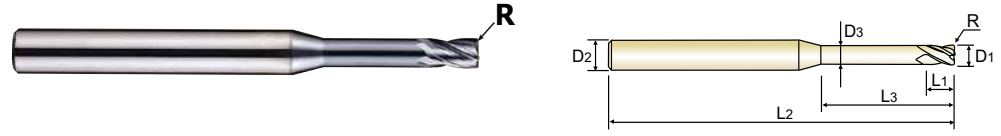

CARBIDE 4 27°/30° ±0.02 PLAIN P.302-305
 Dϕ3, 30° HELIX

EDP No.	Corner Radius	Mill Diameter	Shank Diameter	Length of Cut	Length Below Shank	Overall Length	Neck Diameter	Remark
	R	D1	D2	L1	L3	L2	D3	
SEME6401500512E	R0.05	1.5	4	2.3	12	50	1.45	-
SEME6401500514E	R0.05	1.5	4	2.3	14	50	1.45	-
SEME6401500516E	R0.05	1.5	4	2.3	16	50	1.45	-
SEME6401500520E	R0.05	1.5	4	2.3	20	50	1.45	-
SEME6401500522E	R0.05	1.5	4	2.3	22	60	1.45	-
SEME6401500526E	R0.05	1.5	4	2.3	26	60	1.45	-
SEME640150104E	R0.1	1.5	4	2.3	4	50	1.45	-
★ SEME640150106E	R0.1	1.5	4	2.3	6	50	1.45	-
★ SEME640150108E	R0.1	1.5	4	2.3	8	50	1.45	-
★ SEME640150110E	R0.1	1.5	4	2.3	10	50	1.45	-
★ SEME640150112E	R0.1	1.5	4	2.3	12	50	1.45	-
SEME640150114E	R0.1	1.5	4	2.3	14	50	1.45	-
SEME640150116E	R0.1	1.5	4	2.3	16	50	1.45	-
SEME640150118E	R0.1	1.5	4	2.3	18	50	1.45	-
SEME640150120E	R0.1	1.5	4	2.3	20	50	1.45	-
SEME640150122E	R0.1	1.5	4	2.3	22	60	1.45	-
SEME640150126E	R0.1	1.5	4	2.3	26	60	1.45	-
SEME640150204E	R0.2	1.5	4	2.3	4	50	1.45	-
★ SEME640150206E	R0.2	1.5	4	2.3	6	50	1.45	-
★ SEME640150208E	R0.2	1.5	4	2.3	8	50	1.45	-
★ SEME640150210E	R0.2	1.5	4	2.3	10	50	1.45	-
★ SEME640150212E	R0.2	1.5	4	2.3	12	50	1.45	-
SEME640150214E	R0.2	1.5	4	2.3	14	50	1.45	-
SEME640150216E	R0.2	1.5	4	2.3	16	50	1.45	-

★ : Stock Item ▶ NEXT PAGE

Corner Radius Tolerance (mm)	Mill Dia. Tolerance (mm)	Shank Dia. Tolerance
± 0.02	0 ~ - 0.03	h5

◎ : Excellent ○ : Good

ISO Material Description	P											M			K					
	Non-alloy steel					Low alloy steel				High alloyed steel, and tool steel		Stainless steel			Grey cast iron		Nodular cast iron		Malleable cast iron	
VDI 3323	1	2	3	4	5	6	7	8	9	10	11	12	13	14	15	16	17	18	19	20
HRc		13	25	28	32	10	29	32	38	15	35	15	23	10	10	26	3	25		21
HB	125	190	250	270	300	180	275	300	350	200	325	200	240	180	180	260	160	250	130	230
Recommend	○	◎	◎	◎	◎	○	◎	◎	◎	○	◎	○	○	○	○	○	○	○	○	○

ISO Material Description	N										S							H			
	Aluminum-wrought alloy		Aluminum-cast, alloyed			Copper and Copper Alloys (Bronze / Brass)			Non Metallic Materials		Heat Resistant Super Alloys					Titanium Alloys		Hardened steel	Chilled Cast Iron	Hardened Cast Iron	
VDI 3323	21	22	23	24	25	26	27	28	29	30	31	32	33	34	35	36	37	38	39	40	41
HRc											15	30	25	38	34			55	60	42	55
HB	60	100	75	90	130	110	90	100			200	280	250	350	320	400 Rm	1050 Rm	550	630	400	550
Recommend																		◎	◎	◎	○

CARBIDE, 4 FLUTE MULTIPLE HELIX CORNER RADIUS with EXTENDED NECK

● **VOLLHARTMETALL, 4 SCHNEIDEN MEHRSPIRAL ECKENRADIUS mit ABGESETZTEM SCHAFTTETEL**
 (●) **Fraise carbure, 4 dents, torique, hélice multiple, détalonnée**
 (●) **MD, 4 TAGLIENTI, SCARICATA, TORICA**

- ▶ New coating and tool geometry applied resulting outstanding cutting abilities and wear resistance.
- ▶ Excellent performance when cutting prehardened steels, up to HRC55 which are used for molds & dies.
- ▶ Multiple Helix for 3.0mm and over 3.0mm diameter endmills minimizing vibration and decreasing wear in cutting.

- ▶ Aufgrund einer neuartigen Beschichtung und neuer Werkzeuggeometrien hervorragende Schnittleistung und Verschleißfestigkeit
- ▶ Hervorragende Leistung bei der Zerspaltung von vorvergüteten Stählen bis HRC55, welche im Werkzeug- und Formenbau Verwendung finden.
- ▶ Aufgrund der Multi-Helix (M-Helix) bei Schaftfräsern ≥ 3,0mm ø werden Vibrationen zuverlässig verhindert und gleichzeitig der Schneidkantenverschleiß verringert.

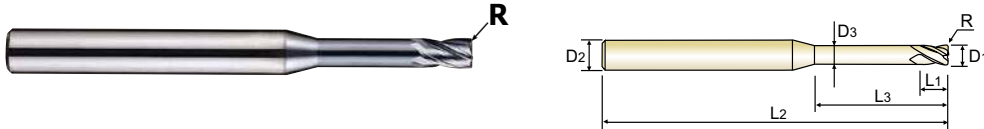

D<ø3, 30° HELIX

Unit : mm

EDP No.	Corner Radius	Mill Diameter	Shank Diameter	Length of Cut	Length Below Shank	Overall Length	Neck Diameter	Remark
	R	D1	D2	L1	L3	L2	D3	
SEME640150220E	R0.2	1.5	4	2.3	20	50	1.45	-
SEME640150222E	R0.2	1.5	4	2.3	22	60	1.45	-
SEME640150226E	R0.2	1.5	4	2.3	26	60	1.45	-
SEME640150304E	R0.3	1.5	4	2.3	4	50	1.45	-
★ SEME640150306E	R0.3	1.5	4	2.3	6	50	1.45	-
★ SEME640150308E	R0.3	1.5	4	2.3	8	50	1.45	-
★ SEME640150310E	R0.3	1.5	4	2.3	10	50	1.45	-
★ SEME640150312E	R0.3	1.5	4	2.3	12	50	1.45	-
SEME640150314E	R0.3	1.5	4	2.3	14	50	1.45	-
SEME640150316E	R0.3	1.5	4	2.3	16	50	1.45	-
SEME640150320E	R0.3	1.5	4	2.3	20	50	1.45	-
SEME640150322E	R0.3	1.5	4	2.3	22	60	1.45	-
SEME640150326E	R0.3	1.5	4	2.3	26	60	1.45	-
SEME640150504E	R0.5	1.5	4	2.3	4	50	1.45	-
★ SEME640150506E	R0.5	1.5	4	2.3	6	50	1.45	-
★ SEME640150508E	R0.5	1.5	4	2.3	8	50	1.45	-
★ SEME640150510E	R0.5	1.5	4	2.3	10	50	1.45	-
★ SEME640150512E	R0.5	1.5	4	2.3	12	50	1.45	-
SEME640150514E	R0.5	1.5	4	2.3	14	50	1.45	-
SEME640150516E	R0.5	1.5	4	2.3	16	50	1.45	-
SEME640150520E	R0.5	1.5	4	2.3	20	50	1.45	-
SEME640150522E	R0.5	1.5	4	2.3	22	60	1.45	-
SEME640150526E	R0.5	1.5	4	2.3	26	60	1.45	-
★ SEME640200106E	R0.1	2.0	4	3	6	50	1.95	-

★ : Stock Item

▶ NEXT PAGE

Corner Radius Tolerance (mm)	Mill Dia. Tolerance (mm)	Shank Dia. Tolerance
± 0.02	0 ~ - 0.03	h5

◎ : Excellent ○ : Good

ISO Material Description	P										M				K						
	Non-alloy steel					Low alloy steel					High alloyed steel, and tool steel				Stainless steel		Grey cast iron		Nodular cast iron		Malleable cast iron
VDI 3323	1	2	3	4	5	6	7	8	9	10	11	12	13	14	15	16	17	18	19	20	
HRC	13	25	28	32	10	29	32	38	15	35	15	23	10	10	26	3	25	13	21		
HB	125	190	250	270	300	180	275	300	350	200	325	200	240	180	180	260	160	250	130	230	
Recommend	○	◎	◎	◎	◎	○	◎	◎	◎	◎	◎	◎	◎	◎	◎	○	○	○	○	○	○

ISO Material Description	N					S					H										
	Aluminum-wrought alloy		Aluminum-cast, alloyed			Copper and Copper Alloys (Bronze / Brass)			Non Metallic Materials		Heat Resistant Super Alloys			Titanium Alloys		Hardened steel	Chilled Cast Iron	Hardened Cast Iron			
VDI 3323	21	22	23	24	25	26	27	28	29	30	31	32	33	34	35	36	37	38	39	40	41
HRC	15	30	25	38	34	15	30	25	38	34	200	280	250	350	320	400 Rm	1050 Rm	550	630	400	550
HB	60	100	75	90	130	110	90	100										550	630	400	550
Recommend																		◎	◎	○	○

YG 4G MILL END MILLS

PLAIN SHANK

SEME64 SERIES

CARBIDE, 4 FLUTE MULTIPLE HELIX CORNER RADIUS with EXTENDED NECK

- **VOLLHARTMETALL, 4 SCHNEIDEN MEHRSPIRAL ECKENRADIUS mit ABGESETZTEM SCHAFTTETL**
- **Fraise carbure, 4 dents, torique, hélice multiple, détalonnée**
- **MD, 4 TAGLIANTI, SCARICATA, TORICA**

- ▶ New coating and tool geometry applied resulting outstanding cutting abilities and wear resistance.
- ▶ Excellent performance when cutting prehardened steels, up to HRC55 which are used for molds & dies.
- ▶ Multiple Helix for 3.0mm and over 3.0mm diameter endmills minimizing vibration and decreasing wear in cutting.

- ▶ Aufgrund einer neuartigen Beschichtung und neuer Werkzeuggeometrien hervorragende Schnittleistung und Verschleißfestigkeit
- ▶ Hervorragende Leistung bei der Zerspaltung von vorvergüteten Stählen bis HRC55, welche im Werkzeug- und Formenbau Verwendung finden.
- ▶ Aufgrund der Multi-Helix (M-Helix) bei Schaftfräsern ≥ 3,0mm Ø werden Vibrationen zuverlässig verhindert und gleichzeitig der Schneidkantenverschleiß verringert.

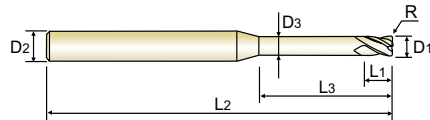

CARBIDE
4
27°/30°
±0.02
PLAIN
P.302-305

D<Ø3, 30° HELIX

Unit : mm

EDP No.	Corner Radius	Mill Diameter	Shank Diameter	Length of Cut	Length Below Shank	Overall Length	Neck Diameter	Remark
	R	D1	D2	L1	L3	L2	D3	
★ SEME640200108E	R0.1	2.0	4	3	8	50	1.95	-
★ SEME640200110E	R0.1	2.0	4	3	10	50	1.95	-
★ SEME640200112E	R0.1	2.0	4	3	12	50	1.95	-
SEME640200114E	R0.1	2.0	4	3	14	50	1.95	-
SEME640200116E	R0.1	2.0	4	3	16	50	1.95	-
SEME640200120E	R0.1	2.0	4	3	20	50	1.95	-
SEME640200122E	R0.1	2.0	4	3	22	60	1.95	-
SEME640200126E	R0.1	2.0	4	3	26	60	1.95	-
SEME640200130E	R0.1	2.0	4	3	30	70	1.95	-
★ SEME640200206E	R0.2	2.0	4	3	6	50	1.95	-
★ SEME640200208E	R0.2	2.0	4	3	8	50	1.95	-
★ SEME640200210E	R0.2	2.0	4	3	10	50	1.95	-
★ SEME640200212E	R0.2	2.0	4	3	12	50	1.95	-
SEME640200214E	R0.2	2.0	4	3	14	50	1.95	-
SEME640200216E	R0.2	2.0	4	3	16	50	1.95	-
SEME640200220E	R0.2	2.0	4	3	20	50	1.95	-
SEME640200222E	R0.2	2.0	4	3	22	60	1.95	-
SEME640200226E	R0.2	2.0	4	3	26	60	1.95	-
SEME640200230E	R0.2	2.0	4	3	30	70	1.95	-
★ SEME640200306E	R0.3	2.0	4	3	6	50	1.95	-
★ SEME640200308E	R0.3	2.0	4	3	8	50	1.95	-
★ SEME640200310E	R0.3	2.0	4	3	10	50	1.95	-
★ SEME640200312E	R0.3	2.0	4	3	12	50	1.95	-
SEME640200314E	R0.3	2.0	4	3	14	50	1.95	-

★ : Stock Item

▶ NEXT PAGE

Corner Radius Tolerance (mm)	Mill Dia. Tolerance (mm)	Shank Dia. Tolerance
± 0.02	0 ~ - 0.03	h5

◎ : Excellent ○ : Good

ISO Material Description	P											M			K						
	Non-alloy steel					Low alloy steel				High alloyed steel, and tool steel		Stainless steel			Grey cast iron		Nodular cast iron		Malleable cast iron		
VDI 3323	1	2	3	4	5	6	7	8	9	10	11	12	13	14	15	16	17	18	19	20	
HRc		13	25	28	32	10	29	32	38	15	35	15	23	10	10	26	3	25		21	
HB	125	190	250	270	300	180	275	300	350	200	325	200	240	180	180	260	160	250	130	230	
Recommend	○	◎	◎	◎	◎	○	◎	◎	◎	○	◎	○	○	○	○	○	○	○	○	○	
ISO Material Description	N					S					H										
	Aluminum-wrought alloy		Aluminum-cast, alloyed			Copper and Copper Alloys (Bronze / Brass)		Non Metallic Materials			Heat Resistant Super Alloys			Titanium Alloys		Hardened steel	Chilled Cast Iron	Hardened Cast Iron			
VDI 3323	21	22	23	24	25	26	27	28	29	30	31	32	33	34	35	36	37	38	39	40	41
HRc											15	30	25	38	34			55	60	42	55
HB	60	100	75	90	130	110	90	100			200	280	250	350	320	400 Rm	1050 Rm	550	630	400	550
Recommend																		◎	◎	◎	○

YG 4G MILL END MILLS

PLAIN SHANK **SEME64** SERIES

CARBIDE, 4 FLUTE MULTIPLE HELIX CORNER RADIUS with EXTENDED NECK

- **VOLLHARTMETALL, 4 SCHNEIDEN MEHRSPIRAL ECKENRADIUS mit ABGESETZTEM SCHAFTTETEL**
- **Fraise carbure, 4 dents, torique, hélice multiple, détalonnée**
- **MD, 4 TAGLIENTI, SCARICATA, TORICA**

- ▶ New coating and tool geometry applied resulting outstanding cutting abilities and wear resistance.
- ▶ Excellent performance when cutting prehardened steels, up to HRC55 which are used for molds & dies.
- ▶ Multiple Helix for 3.0mm and over 3.0mm diameter endmills minimizing vibration and decreasing wear in cutting.

- ▶ Aufgrund einer neuartigen Beschichtung und neuer Werkzeuggeometrien hervorragende Schnittleistung und Verschleißfestigkeit
- ▶ Hervorragende Leistung bei der Zerspaltung von vorvergüteten Stählen bis HRC55, welche im Werkzeug- und Formenbau Verwendung finden.
- ▶ Aufgrund der Multi-Helix (M-Helix) bei Schaftfräsern ≥ 3,0mm ø werden Vibrationen zuverlässig verhindert und gleichzeitig der Schneidkantenverschleiß verringert.

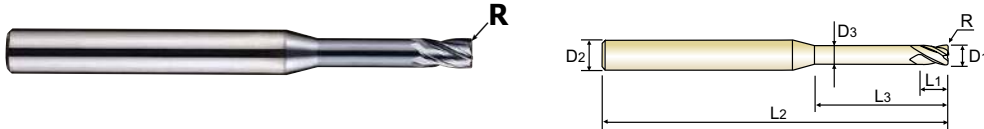

CARBIDE 4 27°/30° ±0.02 PLAIN P.302-305

D<ø3, 30° HELIX

Unit : mm

EDP No.	Corner Radius	Mill Diameter	Shank Diameter	Length of Cut	Length Below Shank	Overall Length	Neck Diameter	Remark
	R	D1	D2	L1	L3	L2	D3	
SEME640200316E	R0.3	2.0	4	3	16	50	1.95	-
SEME640200320E	R0.3	2.0	4	3	20	50	1.95	-
SEME640200322E	R0.3	2.0	4	3	22	60	1.95	-
SEME640200326E	R0.3	2.0	4	3	26	60	1.95	-
SEME640200330E	R0.3	2.0	4	3	30	70	1.95	-
★ SEME640200506E	R0.5	2.0	4	3	6	50	1.95	-
★ SEME640200508E	R0.5	2.0	4	3	8	50	1.95	-
★ SEME640200510E	R0.5	2.0	4	3	10	50	1.95	-
★ SEME640200512E	R0.5	2.0	4	3	12	50	1.95	-
★ SEME640200514E	R0.5	2.0	4	3	14	50	1.95	-
★ SEME640200516E	R0.5	2.0	4	3	16	50	1.95	-
★ SEME640200520E	R0.5	2.0	4	3	20	50	1.95	-
SEME640200522E	R0.5	2.0	4	3	22	60	1.95	-
SEME640200526E	R0.5	2.0	4	3	26	60	1.95	-
SEME640200530E	R0.5	2.0	4	3	30	70	1.95	-
SEME640250108E	R0.1	2.5	4	4	8	50	2.40	-
SEME640250110E	R0.1	2.5	4	4	10	50	2.40	-
SEME640250112E	R0.1	2.5	4	4	12	50	2.40	-
SEME640250114E	R0.1	2.5	4	4	14	50	2.40	-
SEME640250116E	R0.1	2.5	4	4	16	50	2.40	-
SEME640250120E	R0.1	2.5	4	4	20	50	2.40	-
SEME640250126E	R0.1	2.5	4	4	26	60	2.40	-
SEME640250130E	R0.1	2.5	4	4	30	70	2.40	-
SEME640250208E	R0.2	2.5	4	4	8	50	2.40	-

★ : Stock Item

▶ NEXT PAGE

Corner Radius Tolerance (mm)	Mill Dia. Tolerance (mm)	Shank Dia. Tolerance
± 0.02	0 ~ - 0.03	h5

◎ : Excellent ○ : Good

ISO Material Description	P										M				K						
	Non-alloy steel					Low alloy steel					High alloyed steel, and tool steel				Stainless steel		Grey cast iron		Nodular cast iron		Malleable cast iron
VDI 3323	1	2	3	4	5	6	7	8	9	10	11	12	13	14	15	16	17	18	19	20	
HRC	13	25	28	32	10	29	32	38	15	35	15	23	10	10	26	3	25	130	21		
HB	125	190	250	270	300	180	275	300	350	200	325	200	240	180	180	260	160	250	130	230	
Recommend	○	◎	◎	◎	◎	○	◎	◎	◎	◎	◎	◎	◎	◎	◎	○	○	○	○	○	○
ISO Material Description	N										S						H				
	Aluminum-wrought alloy		Aluminum-cast, alloyed			Copper and Copper Alloys (Bronze / Brass)			Non Metallic Materials		Heat Resistant Super Alloys						Titanium Alloys		Hardened steel	Chilled Cast Iron	Hardened Cast Iron
VDI 3323	21	22	23	24	25	26	27	28	29	30	31	32	33	34	35	36	37	38	39	40	41
HRC	21	22	23	24	25	26	27	28	29	30	31	32	33	34	35	36	37	55	60	42	55
HB	60	100	75	90	130	110	90	100			200	280	250	350	320	400 Rm	1050 Rm	550	630	400	550
Recommend																		◎	◎	◎	◎

YG 4G MILL END MILLS

PLAIN SHANK **SEME64** SERIES

CARBIDE, 4 FLUTE MULTIPLE HELIX CORNER RADIUS with EXTENDED NECK

🇩🇪 **VOLLHARTMETALL, 4 SCHNEIDEN MEHRSPIRAL ECKENRADIUS mit ABGESETZTEM SCHAFTTETL**
🇫🇷 **Fraise carbure, 4 dents, torique, hélice multiple, détalonnée**
🇮🇹 **MD, 4 TAGLIANTI, SCARICATA, TORICA**

- ▶ New coating and tool geometry applied resulting outstanding cutting abilities and wear resistance.
 - ▶ Excellent performance when cutting prehardened steels, up to HRC55 which are used for molds & dies.
 - ▶ Multiple Helix for 3.0mm and over 3.0mm diameter endmills minimizing vibration and decreasing wear in cutting.
- ▶ Aufgrund einer neuartigen Beschichtung und neuer Werkzeuggeometrien hervorragende Schnittleistung und Verschleißfestigkeit
 - ▶ Hervorragende Leistung bei der Zerspaltung von vorvergüteten Stählen bis HRC55, welche im Werkzeug- und Formenbau Verwendung finden.
 - ▶ Aufgrund der Multi-Helix (M-Helix) bei Schaftfräsern ≥ 3,0mm Ø werden Vibrationen zuverlässig verhindert und gleichzeitig der Schneidkantenverschleiß verringert.

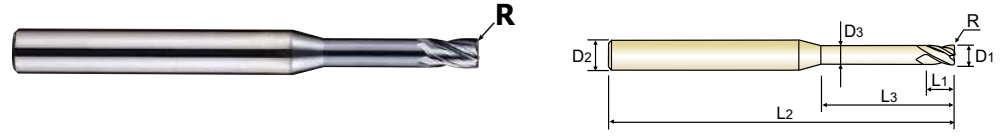

CARBIDE 4 27°/30° ±0.02 PLAIN P.302-305

D<Ø3, 30° HELIX

Unit : mm

EDP No.	Corner Radius	Mill Diameter	Shank Diameter	Length of Cut	Length Below Shank	Overall Length	Neck Diameter	Remark
	R	D1	D2	L1	L3	L2	D3	
SEME640250210E	R0.2	2.5	4	4	10	50	2.40	-
SEME640250212E	R0.2	2.5	4	4	12	50	2.40	-
SEME640250214E	R0.2	2.5	4	4	14	50	2.40	-
SEME640250216E	R0.2	2.5	4	4	16	50	2.40	-
SEME640250220E	R0.2	2.5	4	4	20	50	2.40	-
SEME640250226E	R0.2	2.5	4	4	26	60	2.40	-
SEME640250230E	R0.2	2.5	4	4	30	70	2.40	-
SEME640250308E	R0.3	2.5	4	4	8	50	2.40	-
SEME640250310E	R0.3	2.5	4	4	10	50	2.40	-
SEME640250312E	R0.3	2.5	4	4	12	50	2.40	-
SEME640250314E	R0.3	2.5	4	4	14	50	2.40	-
SEME640250316E	R0.3	2.5	4	4	16	50	2.40	-
SEME640250320E	R0.3	2.5	4	4	20	50	2.40	-
SEME640250326E	R0.3	2.5	4	4	26	60	2.40	-
SEME640250330E	R0.3	2.5	4	4	30	70	2.40	-
SEME640250508E	R0.5	2.5	4	4	8	50	2.40	-
SEME640250510E	R0.5	2.5	4	4	10	50	2.40	-
SEME640250512E	R0.5	2.5	4	4	12	50	2.40	-
SEME640250514E	R0.5	2.5	4	4	14	50	2.40	-
SEME640250516E	R0.5	2.5	4	4	16	50	2.40	-
SEME640250520E	R0.5	2.5	4	4	20	50	2.40	-
SEME640250526E	R0.5	2.5	4	4	26	60	2.40	-
SEME640250530E	R0.5	2.5	4	4	30	70	2.40	-
★ SEME640300108E	R0.1	3.0	6	4.5	8	50	2.85	-

★ : Stock Item

▶ NEXT PAGE

Corner Radius Tolerance (mm)	Mill Dia. Tolerance (mm)	Shank Dia. Tolerance
± 0.02	0 ~ - 0.03	h5

◎ : Excellent ○ : Good

ISO Material Description	P											M			K						
	Non-alloy steel					Low alloy steel				High alloyed steel, and tool steel		Stainless steel			Grey cast iron		Nodular cast iron		Malleable cast iron		
VDI 3323	1	2	3	4	5	6	7	8	9	10	11	12	13	14	15	16	17	18	19	20	
HRc		13	25	28	32	10	29	32	38	15	35	15	23	10	10	26	3	25		21	
HB	125	190	250	270	300	180	275	300	350	200	325	200	240	180	180	260	160	250	130	230	
Recommend	○	◎	◎	◎	◎	○	◎	◎	◎	○	◎	○	○	○	○	○	○	○	○	○	
ISO Material Description	N										S							H			
	Aluminum-wrought alloy		Aluminum-cast, alloyed			Copper and Copper Alloys (Bronze / Brass)			Non Metallic Materials		Heat Resistant Super Alloys					Titanium Alloys		Hardened steel	Chilled Cast Iron	Hardened Cast Iron	
VDI 3323	21	22	23	24	25	26	27	28	29	30	31	32	33	34	35	36	37	38	39	40	41
HRc											15	30	25	38	34			55	60	42	55
HB	60	100	75	90	130	110	90	100			200	280	250	350	320	400 Rm	1050 Rm	550	630	400	550
Recommend																		◎	◎	◎	○

CARBIDE, 4 FLUTE MULTIPLE HELIX CORNER RADIUS with EXTENDED NECK

● **VOLLHARTMETALL, 4 SCHNEIDEN MEHRSPIRAL ECKENRADIUS mit ABGESETZTEM SCHAFTTETEL**
 (●) **Fraise carbure, 4 dents, torique, hélice multiple, détalonnée**
 (●) **MD, 4 TAGLIENTI, SCARICATA, TORICA**

- ▶ New coating and tool geometry applied resulting outstanding cutting abilities and wear resistance.
- ▶ Excellent performance when cutting prehardened steels, up to HRC55 which are used for molds & dies.
- ▶ Multiple Helix for 3.0mm and over 3.0mm diameter endmills minimizing vibration and decreasing wear in cutting.

- ▶ Aufgrund einer neuartigen Beschichtung und neuer Werkzeuggeometrien hervorragende Schnittleistung und Verschleißfestigkeit
- ▶ Hervorragende Leistung bei der Zerspaltung von vorvergüteten Stählen bis HRC55, welche im Werkzeug- und Formenbau Verwendung finden.
- ▶ Aufgrund der Multi-Helix (M-Helix) bei Schaftfräsern ≥ 3,0mm ø werden Vibrationen zuverlässig verhindert und gleichzeitig der Schneidkantenverschleiß verringert.

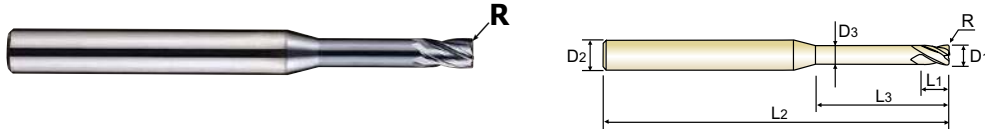

D<ø3, 30° HELIX

Unit : mm

EDP No.	Corner Radius	Mill Diameter	Shank Diameter	Length of Cut	Length Below Shank	Overall Length	Neck Diameter	Remark
	R	D1	D2	L1	L3	L2	D3	
★ SEME640300110E	R0.1	3.0	6	4.5	10	50	2.85	-
★ SEME640300112E	R0.1	3.0	6	4.5	12	50	2.85	-
SEME640300114E	R0.1	3.0	6	4.5	14	60	2.85	-
★ SEME640300116E	R0.1	3.0	6	4.5	16	60	2.85	-
SEME640300120E	R0.1	3.0	6	4.5	20	60	2.85	-
SEME640300126E	R0.1	3.0	6	4.5	26	65	2.85	-
SEME640300130E	R0.1	3.0	6	4.5	30	70	2.85	-
SEME640300135E	R0.1	3.0	6	4.5	35	70	2.85	-
SEME640300140E	R0.1	3.0	6	4.5	40	80	2.85	-
SEME640300208E	R0.2	3.0	6	4.5	8	50	2.85	-
★ SEME640300210E	R0.2	3.0	6	4.5	10	50	2.85	-
★ SEME640300212E	R0.2	3.0	6	4.5	12	50	2.85	-
SEME640300214E	R0.2	3.0	6	4.5	14	60	2.85	-
★ SEME640300216E	R0.2	3.0	6	4.5	16	60	2.85	-
SEME640300218E	R0.2	3.0	6	4.5	18	60	2.85	-
★ SEME640300220E	R0.2	3.0	6	4.5	20	60	2.85	-
SEME640300226E	R0.2	3.0	6	4.5	26	65	2.85	-
SEME640300230E	R0.2	3.0	6	4.5	30	70	2.85	-
SEME640300235E	R0.2	3.0	6	4.5	35	70	2.85	-
SEME640300240E	R0.2	3.0	6	4.5	40	80	2.85	-
★ SEME640300308E	R0.3	3.0	6	4.5	8	50	2.85	-
★ SEME640300310E	R0.3	3.0	6	4.5	10	50	2.85	-
★ SEME640300312E	R0.3	3.0	6	4.5	12	50	2.85	-
★ SEME640300314E	R0.3	3.0	6	4.5	14	60	2.85	-

★ : Stock Item

▶ NEXT PAGE

Corner Radius Tolerance (mm)	Mill Dia. Tolerance (mm)	Shank Dia. Tolerance
± 0.02	0 ~ - 0.03	h5

◎ : Excellent ○ : Good

ISO Material Description	P											M			K					
	Non-alloy steel					Low alloy steel				High alloyed steel, and tool steel		Stainless steel			Grey cast iron		Nodular cast iron		Malleable cast iron	
VDI 3323	1	2	3	4	5	6	7	8	9	10	11	12	13	14	15	16	17	18	19	20
HRC	13	25	28	32	10	29	32	38	15	35	15	23	10	10	26	3	25	130	21	
HB	125	190	250	270	300	180	275	300	350	200	325	200	180	180	260	160	250	130	230	
Recommend	○	◎	◎	◎	◎	○	◎	◎	◎	◎	◎	◎	◎	○	○	○	○	○	○	

ISO Material Description	N										S						H				
	Aluminum-wrought alloy		Aluminum-cast, alloyed			Copper and Copper Alloys (Bronze / Brass)			Non Metallic Materials		Heat Resistant Super Alloys				Titanium Alloys		Hardened steel	Chilled Cast Iron	Hardened Cast Iron		
VDI 3323	21	22	23	24	25	26	27	28	29	30	31	32	33	34	35	36	37	38	39	40	41
HRC	15	30	25	38	34	15	30	25	38	34	200	280	250	350	320	400 Rm	1050 Rm	550	630	400	550
HB	60	100	75	90	130	110	90	100										550	630	400	550
Recommend																		○	◎	◎	○

YG 4G MILL END MILLS

PLAIN SHANK

SEME64 SERIES

CARBIDE, 4 FLUTE MULTIPLE HELIX CORNER RADIUS with EXTENDED NECK

- **VOLLHARTMETALL, 4 SCHNEIDEN MEHRSPIRAL ECKENRADIUS mit ABGESETZTEM SCHAFTTETTEL**
- **Fraise carbure, 4 dents, torique, hélice multiple, détalonnée**
- **MD, 4 TAGLIANTI, SCARICATA, TORICA**

- ▶ New coating and tool geometry applied resulting outstanding cutting abilities and wear resistance.
- ▶ Excellent performance when cutting prehardened steels, up to HRC55 which are used for molds & dies.
- ▶ Multiple Helix for 3.0mm and over 3.0mm diameter endmills minimizing vibration and decreasing wear in cutting.

- ▶ Aufgrund einer neuartigen Beschichtung und neuer Werkzeuggeometrien hervorragende Schnittleistung und Verschleißfestigkeit
- ▶ Hervorragende Leistung bei der Zerspaltung von vorvergüteten Stählen bis HRC55, welche im Werkzeug- und Formenbau Verwendung finden.
- ▶ Aufgrund der Multi-Helix (M-Helix) bei Schaftfräsern $\geq 3,0\text{mm } \phi$ werden Vibrationen zuverlässig verhindert und gleichzeitig der Schneidkantenverschleiß verringert.

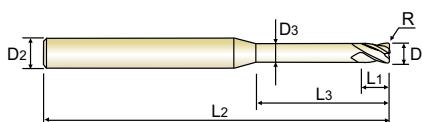

CARBIDE
4
27°/30°
±0.02
PLAIN
P.302-305

Dϕ3, 30° HELIX

Unit : mm

EDP No.	Corner Radius	Mill Diameter	Shank Diameter	Length of Cut	Length Below Shank	Overall Length	Neck Diameter	Remark
	R	D1	D2	L1	L3	L2	D3	
★ SEME640300316E	R0.3	3.0	6	4.5	16	60	2.85	-
★ SEME640300320E	R0.3	3.0	6	4.5	20	60	2.85	-
SEME640300326E	R0.3	3.0	6	4.5	26	65	2.85	-
SEME640300330E	R0.3	3.0	6	4.5	30	70	2.85	-
SEME640300335E	R0.3	3.0	6	4.5	35	70	2.85	-
SEME640300340E	R0.3	3.0	6	4.5	40	80	2.85	-
★ SEME640300508E	R0.5	3.0	6	4.5	8	50	2.85	-
★ SEME640300510E	R0.5	3.0	6	4.5	10	50	2.85	-
★ SEME640300512E	R0.5	3.0	6	4.5	12	50	2.85	-
SEME640300514E	R0.5	3.0	6	4.5	14	60	2.85	-
★ SEME640300516E	R0.5	3.0	6	4.5	16	60	2.85	-
★ SEME640300520E	R0.5	3.0	6	4.5	20	60	2.85	-
★ SEME640300526E	R0.5	3.0	6	4.5	26	65	2.85	-
★ SEME640300530E	R0.5	3.0	6	4.5	30	70	2.85	-
SEME640300535E	R0.5	3.0	6	4.5	35	70	2.85	-
SEME640300540E	R0.5	3.0	6	4.5	40	80	2.85	-
★ SEME640301008E	R1.0	3.0	6	4.5	8	50	2.85	-
★ SEME640301010E	R1.0	3.0	6	4.5	10	50	2.85	-
★ SEME640301012E	R1.0	3.0	6	4.5	12	50	2.85	-
SEME640301014E	R1.0	3.0	6	4.5	14	60	2.85	-
★ SEME640301016E	R1.0	3.0	6	4.5	16	60	2.85	-
★ SEME640301020E	R1.0	3.0	6	4.5	20	60	2.85	-
SEME640301026E	R1.0	3.0	6	4.5	26	65	2.85	-
★ SEME640301030E	R1.0	3.0	6	4.5	30	70	2.85	-

★ : Stock Item

▶ NEXT PAGE

Corner Radius Tolerance (mm)	Mill Dia. Tolerance (mm)	Shank Dia. Tolerance
± 0.02	0 ~ - 0.03	h5

◎ : Excellent ○ : Good

ISO Material Description	P										M			K							
	Non-alloy steel					Low alloy steel					High alloyed steel, and tool steel			Stainless steel			Grey cast iron		Nodular cast iron		Malleable cast iron
VDI 3323	1	2	3	4	5	6	7	8	9	10	11	12	13	14	15	16	17	18	19	20	
HRc		13	25	28	32	10	29	32	38	15	35	15	23	10	10	26	3	25		21	
HB	125	190	250	270	300	180	275	300	350	200	325	200	240	180	180	260	160	250	130	230	
Recommend	○	◎	◎	◎	◎	○	◎	◎	◎	○	◎	○	○	○	○	○	○	○	○	○	
ISO Material Description	N					S					H										
	Aluminum-wrought alloy		Aluminum-cast, alloyed			Copper and Copper Alloys (Bronze / Brass)			Non Metallic Materials		Heat Resistant Super Alloys			Titanium Alloys		Hardened steel		Chilled Cast Iron		Hardened Cast Iron	
VDI 3323	21	22	23	24	25	26	27	28	29	30	31	32	33	34	35	36	37	38	39	40	41
HRc											15	30	25	38	34			55	60	42	55
HB	60	100	75	90	130	110	90	100			200	280	250	350	320	400 Rm	1050 Rm	550	630	400	550
Recommend																		◎	◎	◎	○

CARBIDE, 4 FLUTE MULTIPLE HELIX CORNER RADIUS with EXTENDED NECK

- VOLLHARTMETALL, 4 SCHNEIDEN MEHRSPIRAL ECKENRADIUS mit ABGESETZTEM SCHAFTTETEL
- (●) Fraise carbure, 4 dents, torique, hélice multiple, détalonnée
- (●) MD, 4 TAGLIENTI, SCARICATA, TORICA

- ▶ New coating and tool geometry applied resulting outstanding cutting abilities and wear resistance.
- ▶ Excellent performance when cutting prehardened steels, up to HRC55 which are used for molds & dies.
- ▶ Multiple Helix for 3.0mm and over 3.0mm diameter endmills minimizing vibration and decreasing wear in cutting.

- ▶ Aufgrund einer neuartigen Beschichtung und neuer Werkzeuggeometrien hervorragende Schnittleistung und Verschleißfestigkeit
- ▶ Hervorragende Leistung bei der Zerspaltung von vorvergüteten Stählen bis HRC55, welche im Werkzeug- und Formenbau Verwendung finden.
- ▶ Aufgrund der Multi-Helix (M-Helix) bei Schaftfräsern ≥ 3,0mm Ø werden Vibrationen zuverlässig verhindert und gleichzeitig der Schneidkantenverschleiß verringert.

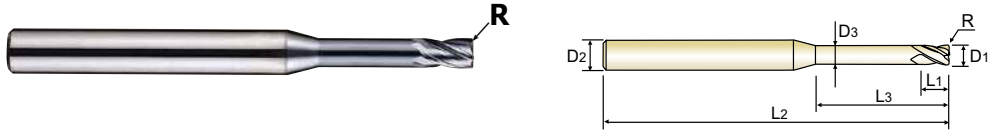

CARBIDE 4 27°/30° ±0.02 PLAIN P.302-305

D<Ø3, 30° HELIX

Unit : mm

EDP No.	Corner Radius	Mill Diameter	Shank Diameter	Length of Cut	Length Below Shank	Overall Length	Neck Diameter	Remark
	R	D1	D2	L1	L3	L2	D3	
SEME640301035E	R1.0	3.0	6	4.5	35	70	2.85	-
SEME640301040E	R1.0	3.0	6	4.5	40	80	2.85	-
★ SEME640400110E	R0.1	4.0	6	6	10	50	3.85	-
★ SEME640400112E	R0.1	4.0	6	6	12	50	3.85	-
SEME640400114E	R0.1	4.0	6	6	14	60	3.85	-
★ SEME640400116E	R0.1	4.0	6	6	16	60	3.85	-
★ SEME640400120E	R0.1	4.0	6	6	20	60	3.85	-
SEME640400126E	R0.1	4.0	6	6	26	65	3.85	-
SEME640400130E	R0.1	4.0	6	6	30	70	3.85	-
SEME640400135E	R0.1	4.0	6	6	35	70	3.85	-
SEME640400140E	R0.1	4.0	6	6	40	80	3.85	-
SEME640400145E	R0.1	4.0	6	6	45	90	3.85	-
SEME640400150E	R0.1	4.0	6	6	50	100	3.85	-
★ SEME640400210E	R0.2	4.0	6	6	10	50	3.85	-
★ SEME640400212E	R0.2	4.0	6	6	12	50	3.85	-
SEME640400214E	R0.2	4.0	6	6	14	60	3.85	-
★ SEME640400216E	R0.2	4.0	6	6	16	60	3.85	-
★ SEME640400220E	R0.2	4.0	6	6	20	60	3.85	-
SEME640400224E	R0.2	4.0	6	6	24	65	3.85	-
★ SEME640400226E	R0.2	4.0	6	6	26	65	3.85	-
SEME640400230E	R0.2	4.0	6	6	30	70	3.85	-
SEME640400235E	R0.2	4.0	6	6	35	70	3.85	-
SEME640400240E	R0.2	4.0	6	6	40	80	3.85	-
SEME640400245E	R0.2	4.0	6	6	45	90	3.85	-

★ : Stock Item

▶ NEXT PAGE

Corner Radius Tolerance (mm)	Mill Dia. Tolerance (mm)	Shank Dia. Tolerance
± 0.02	0 ~ - 0.03	h5

◎ : Excellent ○ : Good

ISO Material Description	P										M				K						
	Non-alloy steel					Low alloy steel					High alloyed steel, and tool steel				Stainless steel		Grey cast iron		Nodular cast iron		Malleable cast iron
VDI 3323	1	2	3	4	5	6	7	8	9	10	11	12	13	14	15	16	17	18	19	20	
HRC	13	25	28	32	10	29	32	38	15	35	15	23	10	10	26	3	25	130	21		
HB	125	190	250	270	300	180	275	300	350	200	325	200	240	180	180	260	160	250	130	230	
Recommend	○	◎	◎	◎	◎	○	◎	◎	◎	◎	◎	◎	◎	◎	○	○	○	○	○	○	

ISO Material Description	N					S										H					
	Aluminum-wrought alloy		Aluminum-cast, alloyed			Copper and Copper Alloys (Bronze / Brass)			Non Metallic Materials		Heat Resistant Super Alloys					Titanium Alloys		Hardened steel	Chilled Cast Iron	Hardened Cast Iron	
VDI 3323	21	22	23	24	25	26	27	28	29	30	31	32	33	34	35	36	37	38	39	40	41
HRC	21	22	23	24	25	26	27	28	29	30	31	32	33	34	35	36	37	38	39	40	41
HB	60	100	75	90	130	110	90	100			200	280	250	350	320	400 Rm	1050 Rm	550	630	400	550
Recommend																		○	◎	◎	○

YG 4G MILL END MILLS

PLAIN SHANK

SEME64 SERIES

CARBIDE, 4 FLUTE MULTIPLE HELIX CORNER RADIUS with EXTENDED NECK

- **VOLLHARTMETALL, 4 SCHNEIDEN MEHRSPIRAL ECKENRADIUS mit ABGESETZTEM SCHAFTTETTEL**
- **Fraise carbure, 4 dents, torique, hélice multiple, détalonnée**
- **MD, 4 TAGLIANTI, SCARICATA, TORICA**

- ▶ New coating and tool geometry applied resulting outstanding cutting abilities and wear resistance.
- ▶ Excellent performance when cutting prehardened steels, up to HRC55 which are used for molds & dies.
- ▶ Multiple Helix for 3.0mm and over 3.0mm diameter endmills minimizing vibration and decreasing wear in cutting.

- ▶ Aufgrund einer neuartigen Beschichtung und neuer Werkzeuggeometrien hervorragende Schnittleistung und Verschleißfestigkeit
- ▶ Hervorragende Leistung bei der Zerspaltung von vorvergüteten Stählen bis HRC55, welche im Werkzeug- und Formenbau Verwendung finden.
- ▶ Aufgrund der Multi-Helix (M-Helix) bei Schaftfräsern $\geq 3,0\text{mm } \phi$ werden Vibrationen zuverlässig verhindert und gleichzeitig der Schneidkantenverschleiß verringert.

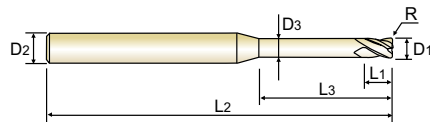

CARBIDE
4
27°/30°
±0.02
PLAIN
P.302-305

Dϕ3, 30° HELIX

Unit : mm

EDP No.	Corner Radius	Mill Diameter	Shank Diameter	Length of Cut	Length Below Shank	Overall Length	Neck Diameter	Remark
	R	D1	D2	L1	L3	L2	D3	
SEME640400250E	R0.2	4.0	6	6	50	100	3.85	-
★ SEME640400310E	R0.3	4.0	6	6	10	50	3.85	-
★ SEME640400312E	R0.3	4.0	6	6	12	50	3.85	-
★ SEME640400314E	R0.3	4.0	6	6	14	60	3.85	-
★ SEME640400316E	R0.3	4.0	6	6	16	60	3.85	-
★ SEME640400320E	R0.3	4.0	6	6	20	60	3.85	-
★ SEME640400326E	R0.3	4.0	6	6	26	65	3.85	-
SEME640400330E	R0.3	4.0	6	6	30	70	3.85	-
SEME640400335E	R0.3	4.0	6	6	35	70	3.85	-
SEME640400340E	R0.3	4.0	6	6	40	80	3.85	-
SEME640400345E	R0.3	4.0	6	6	45	90	3.85	-
SEME640400350E	R0.3	4.0	6	6	50	100	3.85	-
★ SEME640400510E	R0.5	4.0	6	6	10	50	3.85	-
★ SEME640400512E	R0.5	4.0	6	6	12	50	3.85	-
★ SEME640400514E	R0.5	4.0	6	6	14	60	3.85	-
★ SEME640400516E	R0.5	4.0	6	6	16	60	3.85	-
★ SEME640400520E	R0.5	4.0	6	6	20	60	3.85	-
★ SEME640400526E	R0.5	4.0	6	6	26	65	3.85	-
★ SEME640400530E	R0.5	4.0	6	6	30	70	3.85	-
★ SEME640400535E	R0.5	4.0	6	6	35	70	3.85	-
★ SEME640400540E	R0.5	4.0	6	6	40	80	3.85	-
SEME640400545E	R0.5	4.0	6	6	45	90	3.85	-
SEME640400550E	R0.5	4.0	6	6	50	100	3.85	-
★ SEME640401010E	R1.0	4.0	6	6	10	50	3.85	-

★ : Stock Item

▶ NEXT PAGE

Corner Radius Tolerance (mm)	Mill Dia. Tolerance (mm)	Shank Dia. Tolerance
± 0.02	0 ~ - 0.03	h5

◎ : Excellent ○ : Good

ISO Material Description	P											M			K						
	Non-alloy steel					Low alloy steel				High alloyed steel, and tool steel		Stainless steel			Grey cast iron		Nodular cast iron		Malleable cast iron		
VDI 3323	1	2	3	4	5	6	7	8	9	10	11	12	13	14	15	16	17	18	19	20	
HRc		13	25	28	32	10	29	32	38	15	35	15	23	10	10	26	3	25		21	
HB	125	190	250	270	300	180	275	300	350	200	325	200	240	180	180	260	160	250	130	230	
Recommend	○	◎	◎	◎	◎	○	◎	◎	◎	○	◎	○	○	○	○	○	○	○	○	○	
ISO Material Description	N										S							H			
	Aluminum-wrought alloy		Aluminum-cast, alloyed			Copper and Copper Alloys (Bronze / Brass)			Non Metallic Materials		Heat Resistant Super Alloys					Titanium Alloys		Hardened steel	Chilled Cast Iron	Hardened Cast Iron	
VDI 3323	21	22	23	24	25	26	27	28	29	30	31	32	33	34	35	36	37	38	39	40	41
HRc											15	30	25	38	34			55	60	42	55
HB	60	100	75	90	130	110	90	100			200	280	250	350	320	400 Rm	1050 Rm	550	630	400	550
Recommend											○	○	○	○	○	○	○	○	○	◎	○

CARBIDE, 4 FLUTE MULTIPLE HELIX CORNER RADIUS with EXTENDED NECK

● **VOLLHARTMETALL, 4 SCHNEIDEN MEHRSPIRAL ECKENRADIUS mit ABGESETZTEM SCHAFTTETEL**
 (●) **Fraise carbure, 4 dents, torique, hélice multiple, détalonnée**
 (●) **MD, 4 TAGLIENTI, SCARICATA, TORICA**

- ▶ New coating and tool geometry applied resulting outstanding cutting abilities and wear resistance.
- ▶ Excellent performance when cutting prehardened steels, up to HRC55 which are used for molds & dies.
- ▶ Multiple Helix for 3.0mm and over 3.0mm diameter endmills minimizing vibration and decreasing wear in cutting.

- ▶ Aufgrund einer neuartigen Beschichtung und neuer Werkzeuggeometrien hervorragende Schnittleistung und Verschleißfestigkeit
- ▶ Hervorragende Leistung bei der Zerspaltung von vorvergüteten Stählen bis HRC55, welche im Werkzeug- und Formenbau Verwendung finden.
- ▶ Aufgrund der Multi-Helix (M-Helix) bei Schaftfräsern ≥ 3,0mm ø werden Vibrationen zuverlässig verhindert und gleichzeitig der Schneidkantenverschleiß verringert.

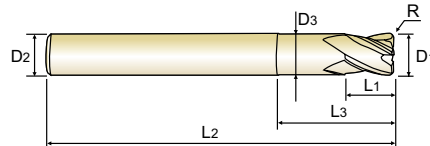

CARBIDE 4 27°/30° ±0.02 PLAIN P.302-305

D<03, 30° HELIX

Unit : mm

EDP No.	Corner Radius	Mill Diameter	Shank Diameter	Length of Cut	Length Below Shank	Overall Length	Neck Diameter	Remark
	R	D1	D2	L1	L3	L2	D3	
★ SEME640401012E	R1.0	4.0	6	6	12	50	3.85	-
SEME640401014E	R1.0	4.0	6	6	14	60	3.85	-
★ SEME640401016E	R1.0	4.0	6	6	16	60	3.85	-
★ SEME640401020E	R1.0	4.0	6	6	20	60	3.85	-
★ SEME640401026E	R1.0	4.0	6	6	26	65	3.85	-
★ SEME640401030E	R1.0	4.0	6	6	30	70	3.85	-
SEME640401035E	R1.0	4.0	6	6	35	70	3.85	-
SEME640401040E	R1.0	4.0	6	6	40	80	3.85	-
SEME640401045E	R1.0	4.0	6	6	45	90	3.85	-
SEME640401050E	R1.0	4.0	6	6	50	100	3.85	-
SEME6405001E	R0.1	5.0	6	8	15	60	4.85	-
SEME6405002E	R0.2	5.0	6	8	15	60	4.85	-
SEME6405003E	R0.3	5.0	6	8	15	60	4.85	-
SEME6405005E	R0.5	5.0	6	8	15	60	4.85	-
SEME6405010E	R1.0	5.0	6	8	15	60	4.85	-
SEME6405015E	R1.5	5.0	6	8	15	60	4.85	-
SEME6405020E	R2.0	5.0	6	8	15	60	4.85	-
SEME6406001E	R0.1	6.0	6	9	20	60	5.85	Regular
★ SEME6406002E	R0.2	6.0	6	9	20	60	5.85	Regular
★ SEME6406003E	R0.3	6.0	6	9	20	60	5.85	Regular
★ SEME6406005E	R0.5	6.0	6	9	20	60	5.85	Regular
★ SEME6406010E	R1.0	6.0	6	9	20	60	5.85	Regular
SEME6406015E	R1.5	6.0	6	9	20	60	5.85	Regular
SEME6406020E	R2.0	6.0	6	9	20	60	5.85	Regular

★ : Stock Item

▶ NEXT PAGE

Corner Radius Tolerance (mm)	Mill Dia. Tolerance (mm)	Shank Dia. Tolerance
± 0.02	0 ~ - 0.03	h5

◎ : Excellent ○ : Good

ISO Material Description	P										M				K						
	Non-alloy steel					Low alloy steel					High alloyed steel, and tool steel				Stainless steel		Grey cast iron		Nodular cast iron		Malleable cast iron
VDI 3323	1	2	3	4	5	6	7	8	9	10	11	12	13	14	15	16	17	18	19	20	
HRC	13	25	28	32	10	29	32	38	15	35	15	23	10	10	26	3	25	130	21		
HB	125	190	250	270	300	180	275	300	350	200	325	200	240	180	180	260	160	250	130	230	
Recommend	○	◎	◎	◎	◎	○	◎	◎	◎	◎	◎	◎	◎	◎	◎	○	○	○	○	○	○

ISO Material Description	N					S										H					
	Aluminum-wrought alloy		Aluminum-cast, alloyed			Copper and Copper Alloys (Bronze / Brass)			Non Metallic Materials		Heat Resistant Super Alloys					Titanium Alloys		Hardened steel	Chilled Cast Iron	Hardened Cast Iron	
VDI 3323	21	22	23	24	25	26	27	28	29	30	31	32	33	34	35	36	37	38	39	40	41
HRC	15	30	25	38	34	15	30	25	38	34	200	280	250	350	320	400 Rm	1050 Rm	550	630	400	550
HB	60	100	75	90	130	110	90	100										550	630	400	550
Recommend																		◎	◎	◎	◎

YG 4G MILL END MILLS

PLAIN SHANK

SEME64 SERIES

CARBIDE, 4 FLUTE MULTIPLE HELIX CORNER RADIUS with EXTENDED NECK

- **VOLLHARTMETALL, 4 SCHNEIDEN MEHRSPIRAL ECKENRADIUS mit ABGESETZTEM SCHAFTTETL**
- **Fraise carbure, 4 dents, torique, hélice multiple, détalonnée**
- **MD, 4 TAGLIANTI, SCARICATA, TORICA**

- ▶ New coating and tool geometry applied resulting outstanding cutting abilities and wear resistance.
- ▶ Excellent performance when cutting prehardened steels, up to HRC55 which are used for molds & dies.
- ▶ Multiple Helix for 3.0mm and over 3.0mm diameter endmills minimizing vibration and decreasing wear in cutting.

- ▶ Aufgrund einer neuartigen Beschichtung und neuer Werkzeuggeometrien hervorragende Schnittleistung und Verschleißfestigkeit
- ▶ Hervorragende Leistung bei der Zerspaltung von vorvergüteten Stählen bis HRC55, welche im Werkzeug- und Formenbau Verwendung finden.
- ▶ Aufgrund der Multi-Helix (M-Helix) bei Schaftfräsern $\geq 3,0\text{mm } \phi$ werden Vibrationen zuverlässig verhindert und gleichzeitig der Schneidkantenverschleiß verringert.

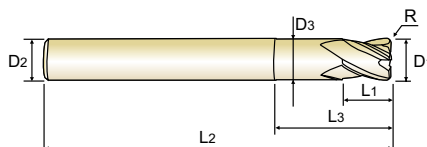

CARBIDE
4
27°/30°
±0.02
PLAIN
P.302-305

Dϕ3, 30° HELIX

Unit : mm

EDP No.	Corner Radius	Mill Diameter	Shank Diameter	Length of Cut	Length Below Shank	Overall Length	Neck Diameter	Remark
	R	D1	D2	L1	L3	L2	D3	
★ SEME6406003090E	R0.3	6.0	6	15	30	90	5.85	Long Shank
SE5E640600524LE	R0.5	6.0	6	9	24	90	5.85	-
★ SEME6406005090E	R0.5	6.0	6	15	30	90	5.85	Long Shank
★ SEME6406010090E	R1.0	6.0	6	15	30	90	5.85	Long Shank
SEME6408001E	R0.1	8.0	8	12	25	70	7.70	Regular
★ SEME6408002E	R0.2	8.0	8	12	25	70	7.70	Regular
★ SEME6408003E	R0.3	8.0	8	12	25	70	7.70	Regular
★ SEME6408005E	R0.5	8.0	8	12	25	70	7.70	Regular
★ SEME6408010E	R1.0	8.0	8	12	25	70	7.70	Regular
SEME6408015E	R1.5	8.0	8	12	25	70	7.70	Regular
SEME6408020E	R2.0	8.0	8	12	25	70	7.70	Regular
SEME6408003100E	R0.3	8.0	8	20	35	100	7.70	Long Shank
★ SEME6408005100E	R0.5	8.0	8	20	35	100	7.70	Long Shank
★ SEME6408010100E	R1.0	8.0	8	20	35	100	7.70	Long Shank
SEME6410001E	R0.1	10.0	10	15	30	75	9.70	Regular
SEME6410002E	R0.2	10.0	10	15	30	75	9.70	Regular
SEME6410003E	R0.3	10.0	10	15	30	75	9.70	Regular
★ SEME6410005E	R0.5	10.0	10	15	30	75	9.70	Regular
★ SEME6410010E	R1.0	10.0	10	15	30	75	9.70	Regular
★ SEME6410015E	R1.5	10.0	10	15	30	75	9.70	Regular
SEME6410020E	R2.0	10.0	10	15	30	75	9.70	Regular
SEME6410003100E	R0.3	10.0	10	25	40	100	9.70	Long Shank
★ SEME6410005100E	R0.5	10.0	10	25	40	100	9.70	Long Shank
★ SEME6410010100E	R1.0	10.0	10	25	40	100	9.70	Long Shank

★ : Stock Item

▶ NEXT PAGE

Corner Radius Tolerance (mm)	Mill Dia. Tolerance (mm)	Shank Dia. Tolerance
± 0.02	0 ~ - 0.03	h5

◎ : Excellent ○ : Good

ISO Material Description	P										M			K							
	Non-alloy steel					Low alloy steel					High alloyed steel, and tool steel			Stainless steel			Grey cast iron		Nodular cast iron		Malleable cast iron
VDI 3323	1	2	3	4	5	6	7	8	9	10	11	12	13	14	15	16	17	18	19	20	
HRc		13	25	28	32	10	29	32	38	15	35	15	23	10	10	26	3	25		21	
HB	125	190	250	270	300	180	275	300	350	200	325	200	240	180	180	260	160	250	130	230	
Recommend	○	◎	◎	◎	◎	○	◎	◎	◎	○	◎	○	○	○	○	○	○	○	○	○	
ISO Material Description	N										S						H				
	Aluminum-wrought alloy		Aluminum-cast, alloyed			Copper and Copper Alloys (Bronze / Brass)			Non Metallic Materials		Heat Resistant Super Alloys			Titanium Alloys			Hardened steel		Chilled Cast Iron	Hardened Cast Iron	
VDI 3323	21	22	23	24	25	26	27	28	29	30	31	32	33	34	35	36	37	38	39	40	41
HRc											15	30	25	38	34			55	60	42	55
HB	60	100	75	90	130	110	90	100			200	280	250	350	320	400 Rm	1050 Rm	550	630	400	550
Recommend																		◎	◎	◎	○

CARBIDE, 4 FLUTE MULTIPLE HELIX CORNER RADIUS with EXTENDED NECK

● **VOLLHARTMETALL, 4 SCHNEIDEN MEHRSPIRAL ECKENRADIUS mit ABGESETZTEM SCHAFTTETEL**
 (●) **Fraise carbure, 4 dents, torique, hélice multiple, détalonnée**
 (●) **MD, 4 TAGLIENTI, SCARICATA, TORICA**

- ▶ New coating and tool geometry applied resulting outstanding cutting abilities and wear resistance.
- ▶ Excellent performance when cutting prehardened steels, up to HRC55 which are used for molds & dies.
- ▶ Multiple Helix for 3.0mm and over 3.0mm diameter endmills minimizing vibration and decreasing wear in cutting.

- ▶ Aufgrund einer neuartigen Beschichtung und neuer Werkzeuggeometrien hervorragende Schnittleistung und Verschleißfestigkeit
- ▶ Hervorragende Leistung bei der Zerspaltung von vorvergüteten Stählen bis HRC55, welche im Werkzeug- und Formenbau Verwendung finden.
- ▶ Aufgrund der Multi-Helix (M-Helix) bei Schaftfräsern $\geq 3,0\text{mm } \phi$ werden Vibrationen zuverlässig verhindert und gleichzeitig der Schneidkantenverschleiß verringert.

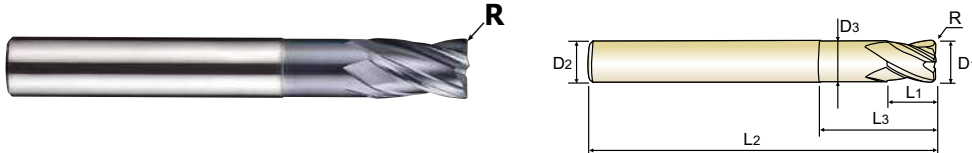

D<03, 30° HELIX

Unit : mm

EDP No.	Corner Radius	Mill Diameter	Shank Diameter	Length of Cut	Length Below Shank	Overall Length	Neck Diameter	Remark
	R	D1	D2	L1	L3	L2	D3	
SEME6412002E	R0.2	12.0	12	18	32	80	11.70	Regular
SEME6412003E	R0.3	12.0	12	18	32	80	11.70	Regular
★ SEME6412005E	R0.5	12.0	12	18	32	80	11.70	Regular
★ SEME6412010E	R1.0	12.0	12	18	32	80	11.70	Regular
★ SEME6412015E	R1.5	12.0	12	18	32	80	11.70	Regular
★ SEME6412020E	R2.0	12.0	12	18	32	80	11.70	Regular
SEME6412003110E	R0.3	12.0	12	30	50	110	11.70	Long Shank
★ SEME6412005110E	R0.5	12.0	12	30	50	110	11.70	Long Shank
★ SEME6412010110E	R1.0	12.0	12	30	50	110	11.70	Long Shank
★ SEME6416005E	R0.5	16.0	16	20	35	100	15.70	Regular
★ SEME6416010E	R1.0	16.0	16	20	35	100	15.70	Regular
SEME6416005150E	R0.5	16.0	16	35	50	150	15.70	Long Shank
SEME6416010150E	R1.0	16.0	16	35	50	150	15.70	Long Shank
★ SEME6420005E	R0.5	20.0	20	35	40	100	19.70	Regular
★ SEME6420010E	R1.0	20.0	20	35	40	100	19.70	Regular
SEME6420005150E	R0.5	20.0	20	35	55	150	19.70	Long Shank
SEME6420010150E	R1.0	20.0	20	35	55	150	19.70	Long Shank

★ : Stock Item

Corner Radius Tolerance (mm)	Mill Dia. Tolerance (mm)	Shank Dia. Tolerance
± 0.02	0 ~ - 0.03	h5

◎ : Excellent ○ : Good

ISO Material Description	P										M			K							
	Non-alloy steel					Low alloy steel					High alloyed steel, and tool steel			Stainless steel			Grey cast iron		Nodular cast iron		Malleable cast iron
VDI 3323	1	2	3	4	5	6	7	8	9	10	11	12	13	14	15	16	17	18	19	20	
HRC	125	13	25	28	32	10	29	32	38	15	35	15	23	10	10	26	3	25	130	21	
HB	125	190	250	270	300	180	275	300	350	200	325	200	240	180	180	260	160	250	130	230	
Recommend	○	◎	◎	◎	◎	○	◎	◎	◎	○	◎				○	○	○	○	○	○	

ISO Material Description	N					S					H											
	Aluminum-wrought alloy		Aluminum-cast, alloyed		Copper and Copper Alloys (Bronze / Brass)	Non Metallic Materials	Heat Resistant Super Alloys			Titanium Alloys		Hardened steel	Chilled Cast Iron	Hardened Cast Iron								
VDI 3323	21	22	23	24	25	26	27	28	29	30	31	32	33	34	35	36	37	38	39	40	41	
HRC	60	100	75	90	130	110	90	100				15	30	25	38	34	400 Rm	1050 Rm	550	630	400	550
HB	60	100	75	90	130	110	90	100				200	280	250	350	320	400 Rm	1050 Rm	550	630	400	550
Recommend																		○	◎	◎	○	

CARBIDE, 2 FLUTE

- **VOLLHARTMETALL, 2 SCHNEIDEN**
- **Fraise carbure, 2 dents**
- **MD, 2 TAGLIENTI, SPIGOLO VIVO**

- ▶ New coating and tool geometry applied resulting outstanding cutting abilities and wear resistance.
- ▶ Excellent performance when cutting prehardened steels, up to HRC55 which are used for molds & dies.
- ▶ From a sharp edge geometry at the end tooth, cutting abilities at work process is increased.

- ▶ Aufgrund einer neuartigen Beschichtung und neuer Werkzeuggeometrien hervorragende Schnittleistung und Verschleißfestigkeit
- ▶ Hervorragende Leistung bei der Zerspannung von vorvergüteten Stählen bis HRC55, welche im Werkzeug- und Formenbau Verwendung finden.
- ▶ Aufgrund der scharfen Schneidengeometrie wird eine bessere Schnittfreudigkeit während der Bearbeitung gewährleistet.

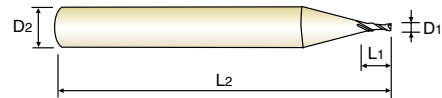

CARBIDE 2 30° PLAIN P.306-309

Unit : mm

EDP No.	Mill Diameter	Shank Diameter	Length of Cut	Overall Length
	D1	D2	L1	L2
★ SEME35001E	0.1	4	0.2	40
★ SEME350015E	0.15	4	0.3	40
★ SEME35002E	0.2	4	0.4	40
SEME350025E	0.25	4	0.5	40
★ SEME35003E	0.3	4	0.6	40
SEME350035E	0.35	4	0.7	40
★ SEME35004E	0.4	4	0.8	40
SEME350045E	0.45	4	0.9	40
★ SEME35005E	0.5	4	1.0	40
SEME350055E	0.55	4	1.1	40
★ SEME35006E	0.6	4	1.2	40
SEME350065E	0.65	4	1.3	40
★ SEME35007E	0.7	4	1.4	40
SEME350075E	0.75	4	1.5	40
★ SEME35008E	0.8	4	1.6	40
SEME350085E	0.85	4	1.7	40
★ SEME35009E	0.9	4	1.8	40
SEME350095E	0.95	4	2	40
★ SEME35010E	1.0	6	2.5	50
★ SEME35012E	1.2	6	3	50
★ SEME35015E	1.5	6	4	50
★ SEME35020E	2.0	6	6	50
★ SEME35025E	2.5	6	7	50
★ SEME35030E	3.0	6	8	50

★ : Stock Item

▶ NEXT PAGE

Size	Mill Dia. Tolerance (mm)	Shank Dia. Tolerance
up to Ø6	0~ - 0.012	h5
over Ø6	0~ - 0.015	

◎ : Excellent ○ : Good

ISO Material Description	P											M				K					
	Non-alloy steel					Low alloy steel				High alloyed steel, and tool steel		Stainless steel		Grey cast iron		Nodular cast iron		Malleable cast iron			
VDI 3323	1	2	3	4	5	6	7	8	9	10	11	12	13	14	15	16	17	18	19	20	
HRc		13	25	28	32	10	29	32	38	15	35	15	23	10	10	26	3	25		21	
HB	125	190	250	270	300	180	275	300	350	200	325	200	240	180	180	260	160	250	130	230	
Recommend	○	○	◎	◎	◎	○	◎	◎	◎	○	◎	○	○	○	○	○	○	○	○	○	
ISO Material Description	N										S							H			
	Aluminum-wrought alloy		Aluminum-cast, alloyed			Copper and Copper Alloys (Bronze / Brass)			Non Metallic Materials		Heat Resistant Super Alloys					Titanium Alloys		Hardened steel	Chilled Cast Iron	Hardened Cast Iron	
VDI 3323	21	22	23	24	25	26	27	28	29	30	31	32	33	34	35	36	37	38	39	40	41
HRc											15	30	25	38	34			55	60	42	55
HB	60	100	75	90	130	110	90	100			200	280	250	350	320	400 Rm	1050 Rm	550	630	400	550
Recommend																		○	◎	◎	○

CARBIDE, 2 FLUTE

- VOLLHARTMETALL, 2 SCHNEIDEN
- Fraise carbure, 2 dents
- MD, 2 TAGLIENTI, SPIGOLO VIVO

- ▶ New coating and tool geometry applied resulting outstanding cutting abilities and wear resistance.
- ▶ Excellent performance when cutting prehardened steels, up to HRC55 which are used for molds & dies.
- ▶ From a sharp edge geometry at the end tooth, cutting abilities at work process is increased.

- ▶ Aufgrund einer neuartigen Beschichtung und neuer Werkzeuggeometrien hervorragende Schnittleistung und Verschleißfestigkeit
- ▶ Hervorragende Leistung bei der Zerspaltung von vorvergüteten Stählen bis HRC55, welche im Werkzeug- und Formenbau Verwendung finden.
- ▶ Aufgrund der scharfen Schneidengeometrie wird eine bessere Schnittfreudigkeit während der Bearbeitung gewährleistet.

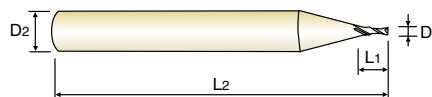

CARBIDE 2 30° PLAIN P.306-309

Unit : mm

EDP No.	Mill Diameter	Shank Diameter	Length of Cut	Overall Length
	D1	D2	L1	L2
★ SEME35035E	3.5	6	10	50
★ SEME35040E	4.0	6	10	50
★ SEME35045E	4.5	6	14	50
★ SEME35050E	5.0	6	15	60
★ SEME35055E	5.5	6	15	60
★ SEME35060E	6.0	6	15	60
★ SEME35065E	6.5	8	18	60
★ SEME35070E	7.0	8	20	60
★ SEME35075E	7.5	8	20	60
★ SEME35080E	8.0	8	20	70
★ SEME35085E	8.5	10	22	70
★ SEME35090E	9.0	10	22	70
★ SEME35095E	9.5	10	24	70
★ SEME35100E	10.0	10	25	75
★ SEME35105E	10.5	12	26	75
★ SEME35110E	11.0	12	30	75
★ SEME35115E	11.5	12	30	80
★ SEME35120E	12.0	12	30	80
★ SEME35130E	13.0	12	35	100
★ SEME3514012SE	14.0	12	35	100
★ SEME3514014SE	14.0	14	35	100
★ SEME35140E	14.0	16	35	100
★ SEME35150E	15.0	16	38	100
★ SEME35160E	16.0	16	40	100

★ : Stock Item

▶ NEXT PAGE

Size	Mill Dia. Tolerance (mm)	Shank Dia. Tolerance
up to Ø6	0~ - 0.012	h5
over Ø6	0~ - 0.015	

◎ : Excellent ○ : Good

ISO Material Description	P										M				K						
	Non-alloy steel					Low alloy steel					High alloyed steel, and tool steel				Stainless steel		Grey cast iron		Nodular cast iron		Malleable cast iron
VDI 3323	1	2	3	4	5	6	7	8	9	10	11	12	13	14	15	16	17	18	19	20	
HRC	13	25	28	32	10	29	32	38	15	35	15	23	10	10	26	3	25	42	21		
HB	125	190	250	270	300	180	275	300	350	200	325	200	240	180	180	260	160	250	130	230	
Recommend	○	○	◎	◎	◎	○	◎	◎	◎	◎	◎	○	○	○	○	○	○	○	○	○	

ISO Material Description	N					S										H					
	Aluminum-wrought alloy		Aluminum-cast, alloyed			Copper and Copper Alloys (Bronze / Brass)			Non Metallic Materials		Heat Resistant Super Alloys					Titanium Alloys		Hardened steel	Chilled Cast Iron	Hardened Cast Iron	
VDI 3323	21	22	23	24	25	26	27	28	29	30	31	32	33	34	35	36	37	38	39	40	41
HRC	21	22	23	24	25	26	27	28	29	30	31	32	33	34	35	36	37	38	39	40	41
HB	60	100	75	90	130	110	90	100			200	280	250	350	320	400 Rm	1050 Rm	550	630	400	550
Recommend																		○	◎	○	○

CARBIDE, 2 FLUTE

- **VOLLHARTMETALL, 2 SCHNEIDEN**
- **Fraise carbure, 2 dents**
- **MD, 2 TAGLIANTI, SPIGOLO VIVO**

- ▶ New coating and tool geometry applied resulting outstanding cutting abilities and wear resistance.
- ▶ Excellent performance when cutting prehardened steels, up to HRC55 which are used for molds & dies.
- ▶ From a sharp edge geometry at the end tooth, cutting abilities at work process is increased.

- ▶ Aufgrund einer neuartigen Beschichtung und neuer Werkzeuggeometrien hervorragende Schnittleistung und Verschleißfestigkeit
- ▶ Hervorragende Leistung bei der Zerspaltung von vorvergüteten Stählen bis HRC55, welche im Werkzeug- und Formenbau Verwendung finden.
- ▶ Aufgrund der scharfen Schneidengeometrie wird eine bessere Schnittfreudigkeit während der Bearbeitung gewährleistet.

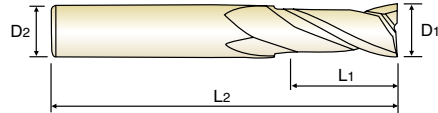
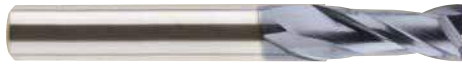

CARBIDE 2 30° PLAIN P.306-309

Unit : mm

EDP No.	Mill Diameter	Shank Diameter	Length of Cut	Overall Length
	D1	D2	L1	L2
SEME35170E	17.0	16	42	100
★ SEME35180E	18.0	16	45	100
SEME3518018SE	18.0	18	45	100
SEME35190E	19.0	20	45	100
★ SEME35200E	20.0	20	45	100
SEME35210E	21.0	20	45	100
SEME35220E	22.0	20	45	100
SEME35230E	23.0	25	50	120
SEME35240E	24.0	25	50	120
SEME35250E	25.0	25	50	120

★ : Stock Item

Size	Mill Dia. Tolerance (mm)	Shank Dia. Tolerance
up to Ø6	0~ - 0.012	h5
over Ø6	0~ - 0.015	

◎ : Excellent ○ : Good

ISO Material Description	P											M				K					
	Non-alloy steel					Low alloy steel				High alloyed steel, and tool steel		Stainless steel		Grey cast iron		Nodular cast iron		Malleable cast iron			
VDI 3323	1	2	3	4	5	6	7	8	9	10	11	12	13	14	15	16	17	18	19	20	
HRc	13	25	28	32	10	29	32	38	15	35	15	23	10	10	26	3	25		21		
HB	125	190	250	270	300	180	275	300	350	200	325	200	240	180	180	260	160	250	130	230	
Recommend	○	○	◎	◎	◎	○	◎	◎	◎	○	◎			○	○	○	○	○	○	○	
ISO Material Description	N										S							H			
	Aluminum-wrought alloy		Aluminum-cast, alloyed			Copper and Copper Alloys (Bronze / Brass)			Non Metallic Materials		Heat Resistant Super Alloys					Titanium Alloys		Hardened steel	Chilled Cast Iron	Hardened Cast Iron	
VDI 3323	21	22	23	24	25	26	27	28	29	30	31	32	33	34	35	36	37	38	39	40	41
HRc											15	30	25	38	34			55	60	42	55
HB	60	100	75	90	130	110	90	100			200	280	250	350	320	400 Rm	1050 Rm	550	630	400	550
Recommend																		○		◎	○

CARBIDE, 2 FLUTE (0.1mm a Unit / 4mm Shank)

- VOLLHARTMETALL, 2 SCHNEIDEN
- Fraise carbure, 2 dents (par 0.1mm / Ø queue 4mm)
- MD, 2 TAGLIENTI, SPIGOLO VIVO (gambo 4 mm)

- ▶ New coating and tool geometry applied resulting outstanding cutting abilities and wear resistance.
- ▶ Excellent performance when cutting prehardened steels, up to HRC55 which are used for molds & dies.
- ▶ From a sharp edge geometry at the end tooth, cutting abilities at work process is increased.

- ▶ Aufgrund einer neuartigen Beschichtung und neuer Werkzeuggeometrien hervorragende Schnittleistung und Verschleißfestigkeit
- ▶ Hervorragende Leistung bei der Zerspaltung von vorvergüteten Stählen bis HRC55, welche im Werkzeug- und Formenbau Verwendung finden.
- ▶ Aufgrund der scharfen Schneidengeometrie wird eine bessere Schnittfreudigkeit während der Bearbeitung gewährleistet.

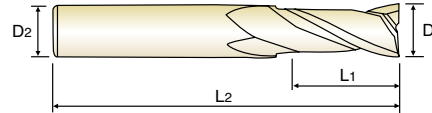

CARBIDE 2 30° PLAIN P.306-309

EDP No.	Mill Diameter	Shank Diameter	Length of Cut	Overall Length
	D1	D2	L1	L2
★ SEME350104SE	1.0	4	2.5	50
★ SEME350114SE	1.1	4	3	50
★ SEME350124SE	1.2	4	3	50
★ SEME350134SE	1.3	4	3	50
★ SEME350144SE	1.4	4	4	50
★ SEME350154SE	1.5	4	4	50
★ SEME350164SE	1.6	4	4	50
★ SEME350174SE	1.7	4	4	50
★ SEME350184SE	1.8	4	5	50
★ SEME350194SE	1.9	4	5	50
★ SEME350204SE	2.0	4	6	50
★ SEME350214SE	2.1	4	6	50
★ SEME350224SE	2.2	4	6	50
★ SEME350234SE	2.3	4	6	50
★ SEME350244SE	2.4	4	6	50
★ SEME350254SE	2.5	4	8	50
★ SEME350264SE	2.6	4	8	50
★ SEME350274SE	2.7	4	8	50
★ SEME350284SE	2.8	4	8	50
★ SEME350294SE	2.9	4	8	50
★ SEME350304SE	3.0	4	8	50
★ SEME350354SE	3.5	4	10	50
★ SEME350404SE	4.0	4	10	50
★ SEME350404S080E	4.0	4	10	80

★ : Stock Item

Mill Dia. Tolerance (mm)	Shank Dia. Tolerance
0~ -0.012	h5

◎ : Excellent ○ : Good

ISO Material Description	P										M				K						
	Non-alloy steel					Low alloy steel					High alloyed steel, and tool steel				Stainless steel		Grey cast iron		Nodular cast iron		Malleable cast iron
VDI 3323	1	2	3	4	5	6	7	8	9	10	11	12	13	14	15	16	17	18	19	20	
HRC	13	25	28	32	10	29	32	38	15	35	15	23	10	10	26	3	25	130	230		
HB	125	190	250	270	300	180	275	300	350	200	325	200	240	180	180	260	160	250	130	230	
Recommend	○	○	◎	◎	◎	○	◎	◎	◎	◎	◎	◎	◎	◎	○	○	○	○	○	○	

ISO Material Description	N										S						H								
	Aluminum-wrought alloy		Aluminum-cast, alloyed			Copper and Copper Alloys (Bronze / Brass)			Non Metallic Materials		Heat Resistant Super Alloys						Titanium Alloys		Hardened steel	Chilled Cast Iron	Hardened Cast Iron				
VDI 3323	21	22	23	24	25	26	27	28	29	30	31	32	33	34	35	36	37	38	39	40	41				
HRC	60	100	75	90	130	110	90	100			15	30	25	38	34	200	280	250	350	400 Rm	1050 Rm	550	630	400	550
Recommend																		○	◎	◎	○				

YG 4G MILL END MILLS

PLAIN SHANK

SEME35 SERIES

CARBIDE, 2 FLUTE (3mm Shank)

- **VOLLHARTMETALL, 2 SCHNEIDEN**
- **Fraise carbure, 2 dents (Ø queue 3 mm)**
- **MD, 2 TAGLIENTI, SPIGOLO VIVO (gambo 3mm)**

- ▶ New coating and tool geometry applied resulting outstanding cutting abilities and wear resistance.
- ▶ Excellent performance when cutting prehardened steels, up to HRC55 which are used for molds & dies.
- ▶ From a sharp edge geometry at the end tooth, cutting abilities at work process is increased.

- ▶ Aufgrund einer neuartigen Beschichtung und neuer Werkzeuggeometrien hervorragende Schnittleistung und Verschleißfestigkeit
- ▶ Hervorragende Leistung bei der Zerspaltung von vorvergüteten Stählen bis HRC55, welche im Werkzeug- und Formenbau Verwendung finden.
- ▶ Aufgrund der scharfen Schneidengeometrie wird eine bessere Schnittfreudigkeit während der Bearbeitung gewährleistet.

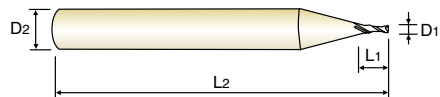

CARBIDE 2 30° PLAIN P.306-309

Unit : mm

EDP No.	Mill Diameter	Shank Diameter	Length of Cut	Overall Length
	D1	D2	L1	L2
★ SEME350013SE	0.1	3	0.2	40
★ SEME350023SE	0.2	3	0.4	40
★ SEME350033SE	0.3	3	0.6	40
★ SEME350043SE	0.4	3	0.8	40
★ SEME350053SE	0.5	3	1.0	40
★ SEME350063SE	0.6	3	1.2	40
★ SEME350073SE	0.7	3	1.4	40
★ SEME350083SE	0.8	3	1.6	40
★ SEME350093SE	0.9	3	1.8	40
★ SEME350103SE	1.0	3	2.5	50
★ SEME350123SE	1.2	3	3	50
★ SEME350153SE	1.5	3	4	50
★ SEME350203SE	2.0	3	6	50
★ SEME350253SE	2.5	3	7	50
★ SEME350303SE	3.0	3	8	50

★ : Stock Item

Mill Dia. Tolerance (mm)	Shank Dia. Tolerance
0~ - 0.012	h5

◎ : Excellent ○ : Good

ISO Material Description	P											M				K					
	Non-alloy steel					Low alloy steel				High alloyed steel, and tool steel		Stainless steel		Grey cast iron		Nodular cast iron		Malleable cast iron			
VDI 3323	1	2	3	4	5	6	7	8	9	10	11	12	13	14	15	16	17	18	19	20	
HRc		13	25	28	32	10	29	32	38	15	35	15	23	10	10	26	3	25		21	
HB	125	190	250	270	300	180	275	300	350	200	325	200	240	180	180	260	160	250	130	230	
Recommend	○	○	◎	◎	◎	○	◎	◎	◎	○	◎			○	○	○	○	○	○	○	
ISO Material Description	N										S							H			
	Aluminum-wrought alloy		Aluminum-cast, alloyed			Copper and Copper Alloys (Bronze / Brass)			Non Metallic Materials		Heat Resistant Super Alloys					Titanium Alloys		Hardened steel	Chilled Cast Iron	Hardened Cast Iron	
VDI 3323	21	22	23	24	25	26	27	28	29	30	31	32	33	34	35	36	37	38	39	40	41
HRc											15	30	25	38	34			55	60	42	55
HB	60	100	75	90	130	110	90	100			200	280	250	350	320	400 Rm	1050 Rm	550	630	400	550
Recommend																		○	◎	◎	○

CARBIDE, 2 FLUTE LONG LENGTH

- VOLLHARTMETALL, 2 SCHNEIDEN LANG
- Fraise carbure, 2 dents, longue
- MD, 2 TAGLIENTI, SPIGOLO VIVO, SERIE LUNGA

- ▶ New coating and tool geometry applied resulting outstanding cutting abilities and wear resistance.
- ▶ Excellent performance when cutting prehardened steels, up to HRC55 which are used for molds & dies.
- ▶ Available in various lengths of cut and also overall lengths.

- ▶ Aufgrund einer neuartigen Beschichtung und neuer Werkzeuggeometrien hervorragende Schnittleistung und Verschleißfestigkeit
- ▶ Hervorragende Leistung bei der Zerspaltung von vorvergüteten Stählen bis HRC55, welche im Werkzeug- und Formenbau Verwendung finden.
- ▶ Erhältlich in verschiebenen Schneiden- und Gesamtlängen.

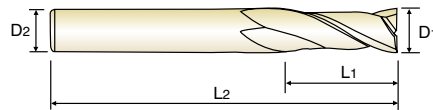

EDP No.	Mill Diameter	Shank Diameter	Length of Cut	Overall Length
	D1	D2	L1	L2
★ SEME7001003E	1.0	6	3	60
★ SEME7001004E	1.0	6	4	60
SEME7001005E	1.0	6	5	60
★ SEME7001006E	1.0	6	6	60
SEME7001007E	1.0	6	7	60
★ SEME7001008E	1.0	6	8	60
★ SEME7001010E	1.0	6	10	60
SEME7001012E	1.0	6	12	60
SEME7001204E	1.2	6	4	60
SEME7001206E	1.2	6	6	60
SEME7001208E	1.2	6	8	60
SEME7001210E	1.2	6	10	60
SEME7001212E	1.2	6	12	60
★ SEME7001506E	1.5	6	6	60
★ SEME7001508E	1.5	6	8	60
★ SEME7001510E	1.5	6	10	60
★ SEME7001512E	1.5	6	12	60
SEME7001514E	1.5	6	14	60
★ SEME7001516E	1.5	6	16	60
★ SEME7002008E	2.0	6	8	60
★ SEME7002010E	2.0	6	10	60
★ SEME7002012E	2.0	6	12	60
SEME7002014E	2.0	6	14	60
★ SEME7002016E	2.0	6	16	60

★ : Stock Item

▶ NEXT PAGE

Mill Dia. Tolerance (mm)	Shank Dia. Tolerance
0 ~ - 0.03	h5

◎ : Excellent ○ : Good

ISO Material Description	P										M			K							
	Non-alloy steel					Low alloy steel					High alloyed steel, and tool steel			Stainless steel			Grey cast iron		Nodular cast iron		Malleable cast iron
VDI 3323	1	2	3	4	5	6	7	8	9	10	11	12	13	14	15	16	17	18	19	20	
HRC	125	13	25	28	32	10	29	32	38	15	35	15	23	10	10	26	3	25	42	21	
HB	125	190	250	270	300	180	275	300	350	200	325	200	240	180	180	260	160	250	130	230	
Recommend	○	○	◎	◎	◎	○	◎	◎	◎	◎	◎	○	○	○	○	○	○	○	○	○	

ISO Material Description	N					S										H					
	Aluminum-wrought alloy		Aluminum-cast, alloyed			Copper and Copper Alloys (Bronze / Brass)			Non Metallic Materials		Heat Resistant Super Alloys					Titanium Alloys		Hardened steel	Chilled Cast Iron	Hardened Cast Iron	
VDI 3323	21	22	23	24	25	26	27	28	29	30	31	32	33	34	35	36	37	38	39	40	41
HRC	60	100	75	90	130	110	90	100			15	30	25	38	34	400 Rm	1050 Rm	550	630	400	550
HB	60	100	75	90	130	110	90	100			200	280	250	350	320	400 Rm	1050 Rm	550	630	400	550
Recommend																		○	◎	◎	○

CARBIDE, 2 FLUTE LONG LENGTH

- **VOLLHARTMETALL, 2 SCHNEIDEN LANG**
- **Fraise carbure, 2 dents, longue**
- **MD, 2 TAGLIANTI, SPIGOLO VIVO, SERIE LUNGA**

- ▶ New coating and tool geometry applied resulting outstanding cutting abilities and wear resistance.
- ▶ Excellent performance when cutting prehardened steels, up to HRc55 which are used for molds & dies.
- ▶ Available in various lengths of cut and also overall lengths.

- ▶ Aufgrund einer neuartigen Beschichtung und neuer Werkzeuggeometrien hervorragende Schnittleistung und Verschleißfestigkeit
- ▶ Hervorragende Leistung bei der Zerspaltung von vorvergüteten Stählen bis HRc55, welche im Werkzeug- und Formenbau Verwendung finden.
- ▶ Erhältlich in verschiedenen Schneiden- und Gesamtlängen.

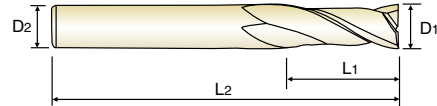

CARBIDE 2 30° PLAIN P.310-315

Unit : mm

EDP No.	Mill Diameter	Shank Diameter	Length of Cut	Overall Length
	D1	D2	L1	L2
★ SEME7002510E	2.5	6	10	60
SEME7002512E	2.5	6	12	60
★ SEME7002516E	2.5	6	16	60
SEME7002520E	2.5	6	20	60
SEME7002526E	2.5	6	26	60
SEME70030163SE	3.0	3	16	100
★ SEME7003010E	3.0	6	10	70
★ SEME7003012E	3.0	6	12	70
★ SEME7003014E	3.0	6	14	70
★ SEME7003016E	3.0	6	16	70
★ SEME7003020E	3.0	6	20	70
★ SEME7003026E	3.0	6	26	70
SEME7003030E	3.0	6	30	70
SEME70040204SE	4.0	4	20	100
★ SEME7004012E	4.0	6	12	70
★ SEME7004016E	4.0	6	16	70
★ SEME7004020E	4.0	6	20	70
★ SEME7004026E	4.0	6	26	70
★ SEME7004030E	4.0	6	30	70
★ SEME7005020E	5.0	6	20	70
★ SEME7005025E	5.0	6	25	70
SEME7005025100E	5.0	6	25	100
★ SEME7005030E	5.0	6	30	80
SEME7005035E	5.0	6	35	90

★ : Stock Item

▶ NEXT PAGE

Mill Dia. Tolerance (mm)	Shank Dia. Tolerance
0 ~ - 0.03	h5

◎ : Excellent ○ : Good

ISO Material Description	P											M			K						
	Non-alloy steel					Low alloy steel				High alloyed steel, and tool steel		Stainless steel			Grey cast iron		Nodular cast iron		Malleable cast iron		
VDI 3323	1	2	3	4	5	6	7	8	9	10	11	12	13	14	15	16	17	18	19	20	
HRc		13	25	28	32	10	29	32	38	15	35	15	23	10	10	26	3	25		21	
HB	125	190	250	270	300	180	275	300	350	200	325	200	240	180	180	260	160	250	130	230	
Recommend	○	○	◎	◎	◎	○	◎	◎	◎	○	◎	○	○	○	○	○	○	○	○	○	
ISO Material Description	N										S							H			
	Aluminum-wrought alloy		Aluminum-cast, alloyed			Copper and Copper Alloys (Bronze / Brass)			Non Metallic Materials		Heat Resistant Super Alloys					Titanium Alloys		Hardened steel	Chilled Cast Iron	Hardened Cast Iron	
VDI 3323	21	22	23	24	25	26	27	28	29	30	31	32	33	34	35	36	37	38	39	40	41
HRc											15	30	25	38	34			55	60	42	55
HB	60	100	75	90	130	110	90	100			200	280	250	350	320	400 Rm	1050 Rm	550	630	400	550
Recommend																		○	◎	◎	○

CARBIDE, 2 FLUTE LONG LENGTH

- VOLLHARTMETALL, 2 SCHNEIDEN LANG
- Fraise carbure, 2 dents, longue
- MD, 2 TAGLIENTI, SPIGOLO VIVO, SERIE LUNGA

- ▶ New coating and tool geometry applied resulting outstanding cutting abilities and wear resistance.
- ▶ Excellent performance when cutting prehardened steels, up to HRC55 which are used for molds & dies.
- ▶ Available in various lengths of cut and also overall lengths.

- ▶ Aufgrund einer neuartigen Beschichtung und neuer Werkzeuggeometrien hervorragende Schnittleistung und Verschleißfestigkeit
- ▶ Hervorragende Leistung bei der Zerspaltung von vorvergüteten Stählen bis HRC55, welche im Werkzeug- und Formenbau Verwendung finden.
- ▶ Erhältlich in verschiebenen Schneiden- und Gesamtlängen.

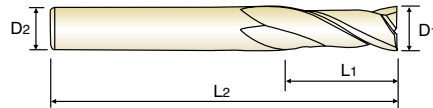

CARBIDE 2 30° PLAIN P.310-315

EDP No.	Mill Diameter	Shank Diameter	Length of Cut	Overall Length
	D1	D2	L1	L2
★ SEME7005040E	5.0	6	40	100
★ SEME7006015E	6.0	6	15	60
★ SEME7006015080E	6.0	6	15	80
★ SEME7006020E	6.0	6	20	70
★ SEME7006020090E	6.0	6	20	90
★ SEME7006025E	6.0	6	25	75
★ SEME7006030E	6.0	6	30	80
★ SEME7006030100E	6.0	6	30	100
★ SEME7006030150E	6.0	6	30	150
★ SEME7006035E	6.0	6	35	90
★ SEME7006040E	6.0	6	40	90
★ SEME7006040120E	6.0	6	40	120
★ SEME7006045E	6.0	6	45	150
★ SEME7008025E	8.0	8	25	80
★ SEME7008030E	8.0	8	30	80
★ SEME7008030100E	8.0	8	30	100
★ SEME7008035E	8.0	8	35	90
★ SEME7008040E	8.0	8	40	90
★ SEME7008040120E	8.0	8	40	120
★ SEME7008040150E	8.0	8	40	150
★ SEME7008045E	8.0	8	45	100
★ SEME7008050E	8.0	8	50	100
★ SEME7008050150E	8.0	8	50	150
★ SEME7010030E	10.0	10	30	80

★ : Stock Item

▶ NEXT PAGE

Mill Dia. Tolerance (mm)	Shank Dia. Tolerance
0 ~ - 0.03	h5

◎ : Excellent ○ : Good

ISO Material Description	P										M			K							
	Non-alloy steel					Low alloy steel					High alloyed steel, and tool steel			Stainless steel			Grey cast iron		Nodular cast iron		Malleable cast iron
VDI 3323	1	2	3	4	5	6	7	8	9	10	11	12	13	14	15	16	17	18	19	20	
HRC		13	25	28	32	10	29	32	38	15	35	15	23	10	10	26	3	25	42	21	
HB	125	190	250	270	300	180	275	300	350	200	325	200	240	180	180	260	160	250	130	230	
Recommend	○	○	◎	◎	◎	○	◎	◎	◎	○	◎	○	◎	◎	○	○	○	○	○	○	

ISO Material Description	N					S										H					
	Aluminum-wrought alloy		Aluminum-cast, alloyed			Copper and Copper Alloys (Bronze / Brass)			Non Metallic Materials		Heat Resistant Super Alloys					Titanium Alloys		Hardened steel	Chilled Cast Iron	Hardened Cast Iron	
VDI 3323	21	22	23	24	25	26	27	28	29	30	31	32	33	34	35	36	37	38	39	40	41
HRC											15	30	25	38	34			55	60	42	55
HB	60	100	75	90	130	110	90	100			200	280	250	350	320	400 Rm	1050 Rm	550	630	400	550
Recommend																		○	◎	◎	○

CARBIDE, 2 FLUTE LONG LENGTH

- **VOLLHARTMETALL, 2 SCHNEIDEN LANG**
- **Fraise carbure, 2 dents, longue**
- **MD, 2 TAGLIENTI, SPIGOLO VIVO, SERIE LUNGA**

- ▶ New coating and tool geometry applied resulting outstanding cutting abilities and wear resistance.
- ▶ Excellent performance when cutting prehardened steels, up to HRc55 which are used for molds & dies.
- ▶ Available in various lengths of cut and also overall lengths.

- ▶ Aufgrund einer neuartigen Beschichtung und neuer Werkzeuggeometrien hervorragende Schnittleistung und Verschleißfestigkeit
- ▶ Hervorragende Leistung bei der Zerspaltung von vorvergüteten Stählen bis HRc55, welche im Werkzeug- und Formenbau Verwendung finden.
- ▶ Erhältlich in verschiebenen Schneiden- und Gesamtlängen.

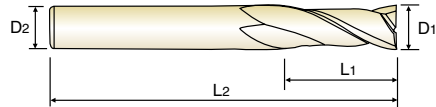

CARBIDE 2 30° PLAIN P.310-315

Unit : mm

EDP No.	Mill Diameter	Shank Diameter	Length of Cut	Overall Length
	D1	D2	L1	L2
★ SEME7010030100E	10.0	10	30	100
★ SEME7010035E	10.0	10	35	90
★ SEME7010040E	10.0	10	40	90
★ SEME7010040120E	10.0	10	40	120
★ SEME7010045E	10.0	10	45	100
★ SEME7010050E	10.0	10	50	100
★ SEME7010050150E	10.0	10	50	150
SEME7010050200E	10.0	10	50	200
SEME7010055E	10.0	10	55	150
★ SEME7010060E	10.0	10	60	110
SEME7010060200E	10.0	10	60	200
★ SEME7012035E	12.0	12	35	90
★ SEME7012040E	12.0	12	40	100
★ SEME7012040120E	12.0	12	40	120
★ SEME7012045E	12.0	12	45	130
★ SEME7012050E	12.0	12	50	100
★ SEME7012050150E	12.0	12	50	150
★ SEME7012055E	12.0	12	55	110
★ SEME7012060E	12.0	12	60	110
★ SEME7012060150E	12.0	12	60	150
SEME7012060200E	12.0	12	60	200
SEME7012065E	12.0	12	65	150
SEME7012070E	12.0	12	70	120
SEME7012070200E	12.0	12	70	200

★ : Stock Item

▶ NEXT PAGE

Mill Dia. Tolerance (mm)	Shank Dia. Tolerance
0 ~ - 0.03	h5

◎ : Excellent ○ : Good

ISO Material Description	P										M			K							
	Non-alloy steel					Low alloy steel					High alloyed steel, and tool steel			Stainless steel			Grey cast iron		Nodular cast iron		Malleable cast iron
VDI 3323	1	2	3	4	5	6	7	8	9	10	11	12	13	14	15	16	17	18	19	20	
HRc		13	25	28	32	10	29	32	38	15	35	15	23	10	10	26	3	25		21	
HB	125	190	250	270	300	180	275	300	350	200	325	200	240	180	180	260	160	250	130	230	
Recommend	○	○	◎	◎	◎	○	◎	◎	◎	○	◎	○	○	○	○	○	○	○	○	○	
ISO Material Description	N										S						H				
	Aluminum-wrought alloy		Aluminum-cast, alloyed			Copper and Copper Alloys (Bronze / Brass)			Non Metallic Materials		Heat Resistant Super Alloys						Titanium Alloys		Hardened steel	Chilled Cast Iron	Hardened Cast Iron
VDI 3323	21	22	23	24	25	26	27	28	29	30	31	32	33	34	35	36	37	38	39	40	41
HRc											15	30	25	38	34			55	60	42	55
HB	60	100	75	90	130	110	90	100			200	280	250	350	320	400 Rm	1050 Rm	550	630	400	550
Recommend																		○	◎	◎	○

CARBIDE, 2 FLUTE LONG LENGTH

- VOLLHARTMETALL, 2 SCHNEIDEN LANG
- Fraise carbure, 2 dents, longue
- MD, 2 TAGLIENTI, SPIGOLO VIVO, SERIE LUNGA

- ▶ New coating and tool geometry applied resulting outstanding cutting abilities and wear resistance.
- ▶ Excellent performance when cutting prehardened steels, up to HRC55 which are used for molds & dies.
- ▶ Available in various lengths of cut and also overall lengths.

- ▶ Aufgrund einer neuartigen Beschichtung und neuer Werkzeuggeometrien hervorragende Schnittleistung und Verschleißfestigkeit
- ▶ Hervorragende Leistung bei der Zerspaltung von vorvergüteten Stählen bis HRC55, welche im Werkzeug- und Formenbau Verwendung finden.
- ▶ Erhältlich in verschiebenen Schneiden- und Gesamtlängen.

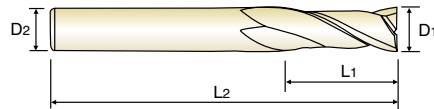

EDP No.	Mill Diameter	Shank Diameter	Length of Cut	Overall Length
	D1	D2	L1	L2
SEME7014050E	14.0	16	50	110
★ SEME7014060E	14.0	16	60	150
★ SEME7016040E	16.0	16	40	150
SEME7016050E	16.0	16	50	110
SEME7016050150E	16.0	16	50	150
SEME7016060E	16.0	16	60	120
SEME7016070E	16.0	16	70	130
★ SEME7016070150E	16.0	16	70	150
SEME7016070200E	16.0	16	70	200
SEME7016080E	16.0	16	80	150
SEME7016090E	16.0	16	90	150
SEME70160110E	16.0	16	110	200
SEME70160120E	16.0	16	120	250
SEME7018050E	18.0	20	50	120
SEME7018070E	18.0	20	70	130
SEME70180100E	18.0	20	100	200
SEME7020050E	20.0	20	50	110
SEME7020050150E	20.0	20	50	150
SEME7020060E	20.0	20	60	130
SEME7020070E	20.0	20	70	130
SEME7020080E	20.0	20	80	150
SEME7020090E	20.0	20	90	150
★ SEME7020090200E	20.0	20	90	200
★ SEME70200110E	20.0	20	110	200

★ : Stock Item

▶ NEXT PAGE

Mill Dia. Tolerance (mm)	Shank Dia. Tolerance
0 ~ - 0.03	h5

◎ : Excellent ○ : Good

ISO Material Description	P										M			K							
	Non-alloy steel					Low alloy steel					High alloyed steel, and tool steel			Stainless steel			Grey cast iron		Nodular cast iron		Malleable cast iron
VDI 3323	1	2	3	4	5	6	7	8	9	10	11	12	13	14	15	16	17	18	19	20	
HRC		13	25	28	32	10	29	32	38	15	35	15	23	10	10	26	3	25	42	21	
HB	125	190	250	270	300	180	275	300	350	200	325	200	240	180	180	260	160	250	130	230	
Recommend	○	○	◎	◎	◎	○	◎	◎	◎	◎	◎	◎	◎	◎	○	○	○	○	○	○	

ISO Material Description	N					S										H					
	Aluminum-wrought alloy		Aluminum-cast, alloyed			Copper and Copper Alloys (Bronze / Brass)			Non Metallic Materials		Heat Resistant Super Alloys					Titanium Alloys		Hardened steel	Chilled Cast Iron	Hardened Cast Iron	
VDI 3323	21	22	23	24	25	26	27	28	29	30	31	32	33	34	35	36	37	38	39	40	41
HRC											15	30	25	38	34			55	60	42	55
HB	60	100	75	90	130	110	90	100			200	280	250	350	320	400 Rm	1050 Rm	550	630	400	550
Recommend																		○	◎	◎	○

CARBIDE, 2 FLUTE LONG LENGTH

- **VOLLHARTMETALL, 2 SCHNEIDEN LANG**
- **Fraise carbure, 2 dents, longue**
- **MD, 2 TAGLIANTI, SPIGOLO VIVO, SERIE LUNGA**

- ▶ New coating and tool geometry applied resulting outstanding cutting abilities and wear resistance.
- ▶ Excellent performance when cutting prehardened steels, up to HRC55 which are used for molds & dies.
- ▶ Available in various lengths of cut and also overall lengths.

- ▶ Aufgrund einer neuartigen Beschichtung und neuer Werkzeuggeometrien hervorragende Schnittleistung und Verschleißfestigkeit
- ▶ Hervorragende Leistung bei der Zerspaltung von vorvergüteten Stählen bis HRC55, welche im Werkzeug- und Formenbau Verwendung finden.
- ▶ Erhältlich in verschiebenen Schneiden- und Gesamtlängen.

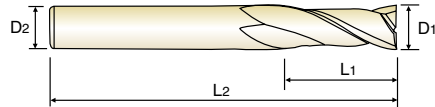

CARBIDE 2 30° PLAIN P.310-315

Unit : mm

EDP No.	Mill Diameter	Shank Diameter	Length of Cut	Overall Length
	D1	D2	L1	L2
SEME70200120E	20.0	20	120	250
SEME7022075E	22.0	20	75	150
SEME70220110E	22.0	20	110	200
SEME7025070E	25.0	25	70	150
SEME7025090E	25.0	25	90	150
SEME70250110E	25.0	25	110	200
SEME70250120E	25.0	25	120	250

★ : Stock Item

Mill Dia. Tolerance (mm)	Shank Dia. Tolerance
0 ~ - 0.03	h5

◎ : Excellent ○ : Good

ISO Material Description	P									M						K					
	Non-alloy steel					Low alloy steel				High alloyed steel, and tool steel		Stainless steel				Grey cast iron		Nodular cast iron		Malleable cast iron	
VDI 3323	1	2	3	4	5	6	7	8	9	10	11	12	13	14	15	16	17	18	19	20	
HRc	13	25	28	32	10	29	32	38	15	35	15	23	10	10	26	3	25	130	21		
HB	125	190	250	270	300	180	275	300	350	200	325	200	240	180	180	260	160	250	130	230	
Recommend	○	○	◎	◎	◎	○	◎	◎	◎	○	◎				○	○	○	○	○	○	
ISO Material Description	N										S							H			
	Aluminum-wrought alloy		Aluminum-cast, alloyed			Copper and Copper Alloys (Bronze / Brass)			Non Metallic Materials		Heat Resistant Super Alloys					Titanium Alloys		Hardened steel	Chilled Cast Iron	Hardened Cast Iron	
VDI 3323	21	22	23	24	25	26	27	28	29	30	31	32	33	34	35	36	37	38	39	40	41
HRc											15	30	25	38	34			55	60	42	55
HB	60	100	75	90	130	110	90	100			200	280	250	350	320	400 Rm	1050 Rm	550	630	400	550
Recommend																		○	◎	◎	○

CARBIDE, 2 FLUTE with EXTENDED NECK

- **VOLLHARTMETALL, 2 SCHNEIDEN mit ABGESETZTEM SCHAFTTETL**
- () **Fraise carbure, 2 dents, détalonnée**
- () **MD, 2 TAGLIENTI, SPIGOLO VIVO, SERIE LUNGA**

- ▶ New coating and tool geometry applied resulting outstanding cutting abilities and wear resistance.
- ▶ Excellent for cutting prehardened steels, carbon steels, alloy steels of molds and dies, up to HRC55 and machine parts.
- ▶ For 1.0mm and under 1.0mm diameter size products, it is designed with a double neck to increase tool rigidity and to minimize vibration.
- ▶ Available in several effective lengths of cut and also overall lengths to apply on various rib processing.
- ▶ Aufgrund einer neuartigen Beschichtung und neuer Werkzeuggeometrien hervorragende Schnittleistung und Verschleißfestigkeit
- ▶ Ausgezeichnet geeignet für das Fräsen von vorvergütetem Stahl, kohlenstoff Stahl, legiertem Stahl für Formen, bis HRC55 und Maschinenbauteile.
- ▶ Bei Fräsen mit einem $\phi \leq 1,0\text{mm}$ gewährleistet die "Doppel-Hals-Geometrie" eine erhöhte Werkzeugsteifigkeit und minimiert Vibrationen während der Bearbeitung.
- ▶ Die Auswahl an verschiedenen Effektiv- und Gesamt-Längen der Werkzeuge ermöglicht die Herstellung der verschiedensten Steg- und Rippen-Variationen.

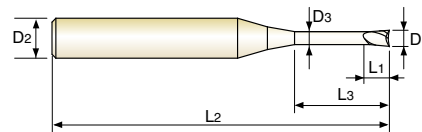

EDP No.	Mill Diameter	Shank Diameter	Length of Cut	Length Below Shank	Overall Length	Neck Diameter
	D1	D2	L1	L3	L2	D3
SEM845001003E	0.1	4	0.15	0.3	40	0.085
★ SEM845001005E	0.1	4	0.15	0.5	40	0.085
SEM84500101E	0.1	4	0.15	1	40	0.085
SEM84500150035SE	0.15	4	0.2	0.35	40	0.13
★ SEM845002005E	0.2	4	0.3	0.5	40	0.17
★ SEM84500201E	0.2	4	0.3	1	40	0.17
★ SEM845002015E	0.2	4	0.3	1.5	40	0.17
★ SEM84500202E	0.2	4	0.3	2	40	0.17
★ SEM84500301E	0.3	4	0.5	1	40	0.27
★ SEM845003015E	0.3	4	0.5	1.5	40	0.27
★ SEM84500302E	0.3	4	0.5	2	40	0.27
SEM845003025E	0.3	4	0.5	2.5	40	0.27
★ SEM84500303E	0.3	4	0.5	3	40	0.27
★ SEM84500304E	0.3	4	0.5	4	40	0.27
SEM84500305E	0.3	4	0.5	5	40	0.27
★ SEM84500401E	0.4	4	0.6	1	40	0.37
★ SEM845004015E	0.4	4	0.6	1.5	40	0.37
★ SEM84500402E	0.4	4	0.6	2	40	0.37
★ SEM845004025E	0.4	4	0.6	2.5	40	0.37
★ SEM84500403E	0.4	4	0.6	3	40	0.37
★ SEM84500404E	0.4	4	0.6	4	40	0.37
★ SEM84500405E	0.4	4	0.6	5	40	0.37
SEM84500406E	0.4	4	0.6	6	40	0.37
SEM84500408E	0.4	4	0.6	8	40	0.37

★ : Stock Item

▶ NEXT PAGE

Size	Mill Dia. Tolerance (mm)	Shank Dia. Tolerance
up to $\phi 6$	0 ~ - 0.012	h5
over $\phi 6$	0 ~ - 0.015	

◎ : Excellent ○ : Good

ISO Material Description	P										M				K						
	Non-alloy steel					Low alloy steel					High alloyed steel, and tool steel				Stainless steel		Grey cast iron		Nodular cast iron		Malleable cast iron
VDI 3323	1	2	3	4	5	6	7	8	9	10	11	12	13	14	15	16	17	18	19	20	
HRC		13	25	28	32	10	29	32	38	15	35	15	23	10	10	26	3	25	42	21	
HB	125	190	250	270	300	180	275	300	350	200	325	200	240	180	180	260	160	250	130	230	
Recommend	○	○	◎	◎	◎	○	◎	◎	◎	◎	◎	○	○	○	○	○	○	○	○	○	

ISO Material Description	N										S						H				
	Aluminum-wrought alloy		Aluminum-cast, alloyed			Copper and Copper Alloys (Bronze / Brass)			Non Metallic Materials		Heat Resistant Super Alloys				Titanium Alloys		Hardened steel	Chilled Cast Iron	Hardened Cast Iron		
VDI 3323	21	22	23	24	25	26	27	28	29	30	31	32	33	34	35	36	37	38	39	40	41
HRC											15	30	25	38	34			55	60	42	55
HB	60	100	75	90	130	110	90	100			200	280	250	350	320	400 Rm	1050 Rm	550	630	400	550
Recommend																		○	◎	○	○

YG 4G MILL END MILLS

PLAIN SHANK

SEM845 SERIES

CARBIDE, 2 FLUTE with EXTENDED NECK

- **VOLLHARTMETALL, 2 SCHNEIDEN mit ABGESETZTEM SCHAFTTETTEL**
- **Fraise carbure, 2 dents, détalonnée**
- **MD, 2 TAGLIANTI, SPIGOLO VIVO, SERIE LUNGA**

- ▶ New coating and tool geometry applied resulting outstanding cutting abilities and wear resistance.
- ▶ Excellent for cutting prehardened steels, carbon steels, alloy steels of molds and dies, up to HRC55 and machine parts.
- ▶ For 1.0mm and under 1.0mm diameter size products, it is designed with a double neck to increase tool rigidity and to minimize vibration.
- ▶ Available in several effective lengths of cut and also overall lengths to apply on various rib processing.

- ▶ Aufgrund einer neuartigen Beschichtung und neuer Werkzeuggeometrien hervorragende Schnittleistung und Verschleißfestigkeit
- ▶ Ausgezeichnet geeignet für das Fräsen von vorvergütetem Stahl, kohlenstoff Stahl, legiertem Stahl für Formen, bis HRC55 und Maschinenbauteile.
- ▶ Bei Fräsern mit einem $\phi \leq 1,0\text{mm}$ gewährleistet die "Doppel-Hals-Geometrie" eine erhöhte Werkzeugsteifigkeit und minimiert Vibrationen während der Bearbeitung.
- ▶ Die Auswahl an verschiedenen Effektiv- und Gesamt-Längen der Werkzeuge ermöglicht die Herstellung der verschiedensten Steg- und Rippen-Variationen.

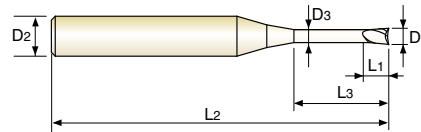

CARBIDE 2 30° PLAIN P.316-325

Unit : mm

EDP No.	Mill Diameter	Shank Diameter	Length of Cut	Length Below Shank	Overall Length	Neck Diameter
	D1	D2	L1	L3	L2	D3
SEM84500410E	0.4	4	0.6	10	40	0.37
★ SEM84500501E	0.5	4	0.7	1	45	0.45
SEM845005015E	0.5	4	0.7	1.5	45	0.45
★ SEM84500502E	0.5	4	0.7	2	45	0.45
SEM845005025E	0.5	4	0.7	2.5	45	0.45
★ SEM84500503E	0.5	4	0.7	3	45	0.45
★ SEM84500504E	0.5	4	0.7	4	45	0.45
★ SEM84500505E	0.5	4	0.7	5	45	0.45
★ SEM84500506E	0.5	4	0.7	6	45	0.45
SEM84500508E	0.5	4	0.7	8	45	0.45
SEM84500510E	0.5	4	0.7	10	45	0.45
SEM84500512E	0.5	4	0.7	12	45	0.45
SEM84500514E	0.5	4	0.7	14	45	0.45
SEM84500516E	0.5	4	0.7	16	45	0.45
★ SEM84500602E	0.6	4	0.9	2	45	0.55
★ SEM84500603E	0.6	4	0.9	3	45	0.55
★ SEM84500604E	0.6	4	0.9	4	45	0.55
★ SEM84500605E	0.6	4	0.9	5	45	0.55
★ SEM84500606E	0.6	4	0.9	6	45	0.55
★ SEM84500608E	0.6	4	0.9	8	45	0.55
★ SEM84500610E	0.6	4	0.9	10	45	0.55
SEM84500612E	0.6	4	0.9	12	45	0.55
SEM84500614E	0.6	4	0.9	14	45	0.55
SEM84500616E	0.6	4	0.9	16	45	0.55

★ : Stock Item

▶ NEXT PAGE

Size	Mill Dia. Tolerance (mm)	Shank Dia. Tolerance
up to $\phi 6$	0 ~ - 0.012	h5
over $\phi 6$	0 ~ - 0.015	

◎ : Excellent ○ : Good

ISO Material Description	P										M				K								
	Non-alloy steel					Low alloy steel					High alloyed steel, and tool steel				Stainless steel				Grey cast iron		Nodular cast iron		Malleable cast iron
VDI 3323	1	2	3	4	5	6	7	8	9	10	11	12	13	14	15	16	17	18	19	20			
HRc		13	25	28	32	10	29	32	38	15	35	15	23	10	10	26	3	25		21			
HB	125	190	250	270	300	180	275	300	350	200	325	200	240	180	180	260	160	250	130	230			
Recommend	○	○	◎	◎	◎	○	◎	◎	◎	○	◎	○	○	○	○	○	○	○	○	○			
ISO Material Description	N										S							H					
	Aluminum-wrought alloy		Aluminum-cast, alloyed			Copper and Copper Alloys (Bronze / Brass)			Non Metallic Materials		Heat Resistant Super Alloys					Titanium Alloys		Hardened steel	Chilled Cast Iron	Hardened Cast Iron			
VDI 3323	21	22	23	24	25	26	27	28	29	30	31	32	33	34	35	36	37	38	39	40	41		
HRc											15	30	25	38	34			55	60	42	55		
HB	60	100	75	90	130	110	90	100			200	280	250	350	320	400 Rm	1050 Rm	550	630	400	550		
Recommend											○	◎	◎	◎	◎	◎	◎	◎	◎	◎	◎		

YG 4G MILL END MILLS

PLAIN SHANK **SEM845** SERIES

CARBIDE, 2 FLUTE with EXTENDED NECK

- VOLLHARTMETALL, 2 SCHNEIDEN mit ABGESETZTEM SCHAFTTETEL
- Fraise carbure, 2 dents, détalonnée
- MD, 2 TAGLIENTI, SPIGOLO VIVO, SERIE LUNGA

- ▶ New coating and tool geometry applied resulting outstanding cutting abilities and wear resistance.
- ▶ Excellent for cutting prehardened steels, carbon steels, alloy steels of molds and dies, up to HRC55 and machine parts.
- ▶ For 1.0mm and under 1.0mm diameter size products, it is designed with a double neck to increase tool rigidity and to minimize vibration.
- ▶ Available in several effective lengths of cut and also overall lengths to apply on various rib processing.
- ▶ Aufgrund einer neuartigen Beschichtung und neuer Werkzeuggeometrien hervorragende Schnittleistung und Verschleißfestigkeit
- ▶ Ausgezeichnet geeignet für das Fräsen von vorvergütetem Stahl, kohlenstoff Stahl, legiertem Stahl für Formen, bis HRC55 und Maschinenbauteile.
- ▶ Bei Fräsern mit einem $\phi \leq 1,0\text{mm}$ gewährleistet die "Doppel-Hals-Geometrie" eine erhöhte Werkzeugsteifigkeit und minimiert Vibrationen während der Bearbeitung.
- ▶ Die Auswahl an verschiedenen Effektiv- und Gesamt-Längen der Werkzeuge ermöglicht die Herstellung der verschiedensten Steg- und Rippen-Variationen.

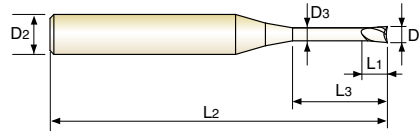

CARBIDE 2 30° PLAIN P.316-325

EDP No.	Mill Diameter	Shank Diameter	Length of Cut	Length Below Shank	Overall Length	Neck Diameter
	D1	D2	L1	L3	L2	D3
★ SEM84500702E	0.7	4	1.2	2	45	0.65
★ SEM84500704E	0.7	4	1.2	4	45	0.65
★ SEM84500706E	0.7	4	1.2	6	45	0.65
SEM84500708E	0.7	4	1.2	8	45	0.65
SEM84500710E	0.7	4	1.2	10	45	0.65
SEM84500712E	0.7	4	1.2	12	45	0.65
★ SEM84500802E	0.8	4	1.2	2	45	0.75
★ SEM84500803E	0.8	4	1.2	3	45	0.75
★ SEM84500804E	0.8	4	1.2	4	45	0.75
★ SEM84500805E	0.8	4	1.2	5	45	0.75
★ SEM84500806E	0.8	4	1.2	6	45	0.75
★ SEM84500808E	0.8	4	1.2	8	45	0.75
★ SEM84500810E	0.8	4	1.2	10	45	0.75
SEM84500812E	0.8	4	1.2	12	45	0.75
SEM84500814E	0.8	4	1.2	14	45	0.75
SEM84500816E	0.8	4	1.2	16	45	0.75
SEM84500820E	0.8	4	1.2	20	45	0.75
SEM84500906E	0.9	4	1.3	6	45	0.85
SEM84500908E	0.9	4	1.3	8	45	0.85
SEM84500910E	0.9	4	1.3	10	45	0.85
★ SEM84501002E	1.0	4	1.5	2	50	0.95
★ SEM84501003E	1.0	4	1.5	3	50	0.95
★ SEM84501004E	1.0	4	1.5	4	50	0.95
★ SEM84501005E	1.0	4	1.5	5	50	0.95

★ : Stock Item

▶ NEXT PAGE

Size	Mill Dia. Tolerance (mm)	Shank Dia. Tolerance
up to $\phi 6$	0 ~ - 0.012	h5
over $\phi 6$	0 ~ - 0.015	

◎ : Excellent ○ : Good

ISO Material Description	P										M				K					
	Non-alloy steel					Low alloy steel					High alloyed steel, and tool steel		Stainless steel		Grey cast iron		Nodular cast iron		Malleable cast iron	
VDI 3323	1	2	3	4	5	6	7	8	9	10	11	12	13	14	15	16	17	18	19	20
HRC		13	25	28	32	10	29	32	38	15	35	15	23	10	10	26	3	25	42	21
HB	125	190	250	270	300	180	275	300	350	200	325	200	240	180	180	260	160	250	130	230
Recommend	○	○	◎	◎	◎	○	◎	◎	◎	◎	◎	○	○	○	○	○	○	○	○	○

ISO Material Description	N										S						H				
	Aluminum-wrought alloy		Aluminum-cast, alloyed			Copper and Copper Alloys (Bronze / Brass)			Non Metallic Materials		Heat Resistant Super Alloys				Titanium Alloys		Hardened steel	Chilled Cast Iron	Hardened Cast Iron		
VDI 3323	21	22	23	24	25	26	27	28	29	30	31	32	33	34	35	36	37	38	39	40	41
HRC											15	30	25	38	34			55	60	42	55
HB	60	100	75	90	130	110	90	100			200	280	250	350	320	400 Rm	1050 Rm	550	630	400	550
Recommend																		○	◎	○	○

YG 4G MILL END MILLS

PLAIN SHANK

SEM845 SERIES

CARBIDE, 2 FLUTE with EXTENDED NECK

- **VOLLHARTMETALL, 2 SCHNEIDEN mit ABGESETZTEM SCHAFTTETTEL**
- **Fraise carbure, 2 dents, détalonnée**
- **MD, 2 TAGLIENTI, SPIGOLO VIVO, SERIE LUNGA**

- ▶ New coating and tool geometry applied resulting outstanding cutting abilities and wear resistance.
- ▶ Excellent for cutting prehardened steels, carbon steels, alloy steels of molds and dies, up to HRC55 and machine parts.
- ▶ For 1.0mm and under 1.0mm diameter size products, it is designed with a double neck to increase tool rigidity and to minimize vibration.
- ▶ Available in several effective lengths of cut and also overall lengths to apply on various rib processing.

- ▶ Aufgrund einer neuartigen Beschichtung und neuer Werkzeuggeometrien hervorragende Schnittleistung und Verschleißfestigkeit
- ▶ Ausgezeichnet geeignet für das Fräsen von vorvergütetem Stahl, kohlenstoff Stahl, legiertem Stahl für Formen, bis HRC55 und Maschinenbauteile.
- ▶ Bei Fräsern mit einem $\phi \leq 1,0\text{mm}$ gewährleistet die "Doppel-Hals-Geometrie" eine erhöhte Werkzeugsteifigkeit und minimiert Vibrationen während der Bearbeitung.
- ▶ Die Auswahl an verschiedenen Effektiv- und Gesamt-Längen der Werkzeuge ermöglicht die Herstellung der verschiedensten Steg- und Rippen-Variationen.

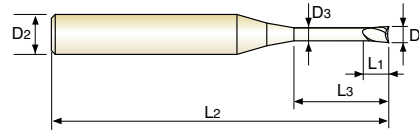

CARBIDE 2 30° PLAIN P.316-325

Unit : mm

EDP No.	Mill Diameter	Shank Diameter	Length of Cut	Length Below Shank	Overall Length	Neck Diameter
	D1	D2	L1	L3	L2	D3
★ SEM84501006E	1.0	4	1.5	6	50	0.95
SEM84501007E	1.0	4	1.5	7	50	0.95
★ SEM84501008E	1.0	4	1.5	8	50	0.95
★ SEM84501010E	1.0	4	1.5	10	50	0.95
★ SEM84501012E	1.0	4	1.5	12	50	0.95
★ SEM84501014E	1.0	4	1.5	14	50	0.95
★ SEM84501016E	1.0	4	1.5	16	50	0.95
SEM84501018E	1.0	4	1.5	18	50	0.95
★ SEM84501020E	1.0	4	1.5	20	50	0.95
SEM84501022E	1.0	4	1.5	22	60	0.95
SEM84501026E	1.0	4	1.5	26	60	0.95
SEM84501030E	1.0	4	1.5	30	70	0.95
SEM84501040E	1.0	4	1.5	40	80	0.95
SEM84501050E	1.0	4	1.5	50	100	0.95
SEM84501204E	1.2	4	1.8	4	50	1.15
★ SEM84501206E	1.2	4	1.8	6	50	1.15
★ SEM84501208E	1.2	4	1.8	8	50	1.15
★ SEM84501210E	1.2	4	1.8	10	50	1.15
★ SEM84501212E	1.2	4	1.8	12	50	1.15
SEM84501214E	1.2	4	1.8	14	50	1.15
SEM84501216E	1.2	4	1.8	16	50	1.15
SEM84501220E	1.2	4	1.8	20	50	1.15
SEM84501226E	1.2	4	1.8	26	60	1.15
SEM84501230E	1.2	4	1.8	30	70	1.15

★ : Stock Item

▶ NEXT PAGE

Size	Mill Dia. Tolerance (mm)	Shank Dia. Tolerance
up to $\phi 6$	0 ~ - 0.012	h5
over $\phi 6$	0 ~ - 0.015	

◎ : Excellent ○ : Good

ISO Material Description	P										M				K								
	Non-alloy steel					Low alloy steel					High alloyed steel, and tool steel				Stainless steel				Grey cast iron		Nodular cast iron		Malleable cast iron
VDI 3323	1	2	3	4	5	6	7	8	9	10	11	12	13	14	15	16	17	18	19	20			
HRc		13	25	28	32	10	29	32	38	15	35	15	23	10	10	26	3	25		21			
HB	125	190	250	270	300	180	275	300	350	200	325	200	240	180	180	260	160	250	130	230			
Recommend	○	○	◎	◎	◎	○	◎	◎	◎	○	◎	○	○	○	○	○	○	○	○	○			
ISO Material Description	N										S						H						
	Aluminum-wrought alloy		Aluminum-cast, alloyed			Copper and Copper Alloys (Bronze / Brass)			Non Metallic Materials		Heat Resistant Super Alloys						Titanium Alloys		Hardened steel		Chilled Cast Iron		Hardened Cast Iron
VDI 3323	21	22	23	24	25	26	27	28	29	30	31	32	33	34	35	36	37	38	39	40	41		
HRc											15	30	25	38	34			55	60	42	55		
HB	60	100	75	90	130	110	90	100			200	280	250	350	320	400 Rm	1050 Rm	550	630	400	550		
Recommend											○	◎	◎	◎	◎	◎	◎	◎	◎	◎	◎		

YG 4G MILL END MILLS

PLAIN SHANK **SEM845** SERIES

CARBIDE, 2 FLUTE with EXTENDED NECK

- VOLLHARTMETALL, 2 SCHNEIDEN mit ABGESETZTEM SCHAFTTETEL
- Fraise carbure, 2 dents, détalonnée
- MD, 2 TAGLIENTI, SPIGOLO VIVO, SERIE LUNGA

- ▶ New coating and tool geometry applied resulting outstanding cutting abilities and wear resistance.
- ▶ Excellent for cutting prehardened steels, carbon steels, alloy steels of molds and dies, up to HRC55 and machine parts.
- ▶ For 1.0mm and under 1.0mm diameter size products, it is designed with a double neck to increase tool rigidity and to minimize vibration.
- ▶ Available in several effective lengths of cut and also overall lengths to apply on various rib processing.
- ▶ Aufgrund einer neuartigen Beschichtung und neuer Werkzeuggeometrien hervorragende Schnittleistung und Verschleißfestigkeit
- ▶ Ausgezeichnet geeignet für das Fräsen von vorvergütetem Stahl, kohlenstoff Stahl, legiertem Stahl für Formen, bis HRC55 und Maschinenbauteile.
- ▶ Bei Fräsern mit einem $\phi \leq 1,0\text{mm}$ gewährleistet die "Doppel-Hals-Geometrie" eine erhöhte Werkzeugsteifigkeit und minimiert Vibrationen während der Bearbeitung.
- ▶ Die Auswahl an verschiedenen Effektiv- und Gesamt-Längen der Werkzeuge ermöglicht die Herstellung der verschiedensten Steg- und Rippen-Variationen.

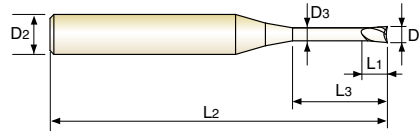

CARBIDE 2 30° PLAIN P.316-325

Unit : mm

EDP No.	Mill Diameter	Shank Diameter	Length of Cut	Length Below Shank	Overall Length	Neck Diameter
	D1	D2	L1	L3	L2	D3
★ SEM84501406E	1.4	4	2.1	6	50	1.35
★ SEM84501408E	1.4	4	2.1	8	50	1.35
SEM84501410E	1.4	4	2.1	10	50	1.35
SEM84501414E	1.4	4	2.1	14	50	1.35
SEM84501416E	1.4	4	2.1	16	50	1.35
SEM84501420E	1.4	4	2.1	20	50	1.35
★ SEM84501504E	1.5	4	2.3	4	50	1.45
SEM84501505E	1.5	4	2.3	5	50	1.45
★ SEM84501506E	1.5	4	2.3	6	50	1.45
SEM84501507E	1.5	4	2.3	7	50	1.45
★ SEM84501508E	1.5	4	2.3	8	50	1.45
★ SEM84501510E	1.5	4	2.3	10	50	1.45
★ SEM84501512E	1.5	4	2.3	12	50	1.45
★ SEM84501514E	1.5	4	2.3	14	50	1.45
★ SEM84501516E	1.5	4	2.3	16	50	1.45
★ SEM84501518E	1.5	4	2.3	18	50	1.45
★ SEM84501520E	1.5	4	2.3	20	50	1.45
SEM84501522E	1.5	4	2.3	22	60	1.45
SEM84501526E	1.5	4	2.3	26	60	1.45
SEM84501530E	1.5	4	2.3	30	70	1.45
SEM84501608E	1.6	4	2.3	8	50	1.55
SEM84501610E	1.6	4	2.3	10	50	1.55
SEM84501612E	1.6	4	2.3	12	50	1.55
SEM84501616E	1.6	4	2.3	16	50	1.55

★ : Stock Item

▶ NEXT PAGE

Size	Mill Dia. Tolerance (mm)	Shank Dia. Tolerance
up to $\phi 6$	0 ~ - 0.012	h5
over $\phi 6$	0 ~ - 0.015	

◎ : Excellent ○ : Good

ISO Material Description	P										M				K					
	Non-alloy steel					Low alloy steel					High alloyed steel, and tool steel		Stainless steel		Grey cast iron		Nodular cast iron		Malleable cast iron	
VDI 3323	1	2	3	4	5	6	7	8	9	10	11	12	13	14	15	16	17	18	19	20
HRC		13	25	28	32	10	29	32	38	15	35	15	23	10	10	26	3	25	42	21
HB	125	190	250	270	300	180	275	300	350	200	325	200	240	180	180	260	160	250	130	230
Recommend	○	○	◎	◎	◎	○	◎	◎	◎	◎	◎	○	○	○	○	○	○	○	○	○

ISO Material Description	N										S						H				
	Aluminum-wrought alloy		Aluminum-cast, alloyed			Copper and Copper Alloys (Bronze / Brass)			Non Metallic Materials		Heat Resistant Super Alloys				Titanium Alloys		Hardened steel	Chilled Cast Iron	Hardened Cast Iron		
VDI 3323	21	22	23	24	25	26	27	28	29	30	31	32	33	34	35	36	37	38	39	40	41
HRC											15	30	25	38	34			55	60	42	55
HB	60	100	75	90	130	110	90	100			200	280	250	350	320	400 Rm	1050 Rm	550	630	400	550
Recommend																		○	◎	○	○

YG 4G MILL END MILLS

PLAIN SHANK

SEM845 SERIES

CARBIDE, 2 FLUTE with EXTENDED NECK

- **VOLLHARTMETALL, 2 SCHNEIDEN mit ABGESETZTEM SCHAFTTETTEL**
- **Fraise carbure, 2 dents, détalonnée**
- **MD, 2 TAGLIENTI, SPIGOLO VIVO, SERIE LUNGA**

- ▶ New coating and tool geometry applied resulting outstanding cutting abilities and wear resistance.
- ▶ Excellent for cutting prehardened steels, carbon steels, alloy steels of molds and dies, up to HRC55 and machine parts.
- ▶ For 1.0mm and under 1.0mm diameter size products, it is designed with a double neck to increase tool rigidity and to minimize vibration.
- ▶ Available in several effective lengths of cut and also overall lengths to apply on various rib processing.

- ▶ Aufgrund einer neuartigen Beschichtung und neuer Werkzeuggeometrien hervorragende Schnittleistung und Verschleißfestigkeit
- ▶ Ausgezeichnet geeignet für das Fräsen von vorvergütetem Stahl, kohlenstoff Stahl, legiertem Stahl für Formen, bis HRC55 und Maschinenbauteile.
- ▶ Bei Fräsern mit einem $\phi \leq 1,0\text{mm}$ gewährleistet die "Doppel-Hals-Geometrie" eine erhöhte Werkzeugsteifigkeit und minimiert Vibrationen während der Bearbeitung.
- ▶ Die Auswahl an verschiedenen Effektiv- und Gesamt-Längen der Werkzeuge ermöglicht die Herstellung der verschiedensten Steg- und Rippen-Variationen.

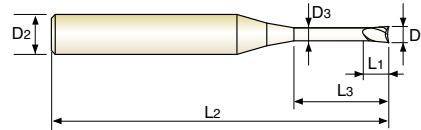

CARBIDE 2 30° PLAIN P.316-325

Unit : mm

EDP No.	Mill Diameter	Shank Diameter	Length of Cut	Length Below Shank	Overall Length	Neck Diameter
	D1	D2	L1	L3	L2	D3
SEM84501620E	1.6	4	2.3	20	50	1.55
★ SEM84501808E	1.8	4	2.7	8	50	1.75
★ SEM84501810E	1.8	4	2.7	10	50	1.75
★ SEM84501812E	1.8	4	2.7	12	50	1.75
SEM84501816E	1.8	4	2.7	16	50	1.75
SEM84501820E	1.8	4	2.7	20	50	1.75
★ SEM84502006E	2.0	4	3	6	50	1.95
★ SEM84502008E	2.0	4	3	8	50	1.95
★ SEM84502010E	2.0	4	3	10	50	1.95
★ SEM84502012E	2.0	4	3	12	50	1.95
★ SEM84502014E	2.0	4	3	14	50	1.95
★ SEM84502016E	2.0	4	3	16	50	1.95
SEM84502018E	2.0	4	3	18	50	1.95
★ SEM84502020E	2.0	4	3	20	50	1.95
SEM84502022E	2.0	4	3	22	60	1.95
★ SEM84502026E	2.0	4	3	26	60	1.95
★ SEM84502030E	2.0	4	3	30	70	1.95
★ SEM84502035E	2.0	4	3	35	70	1.95
★ SEM84502040E	2.0	4	3	40	80	1.95
SEM84502045E	2.0	4	3	45	90	1.95
SEM84502050E	2.0	4	3	50	100	1.95
SEM84502060E	2.0	4	3	60	110	1.95
★ SEM84502508E	2.5	4	4	8	50	2.40
★ SEM84502510E	2.5	4	4	10	50	2.40

★ : Stock Item

▶ NEXT PAGE

Size	Mill Dia. Tolerance (mm)	Shank Dia. Tolerance
up to $\phi 6$	0 ~ - 0.012	h5
over $\phi 6$	0 ~ - 0.015	

◎ : Excellent ○ : Good

ISO Material Description	P										M				K						
	Non-alloy steel					Low alloy steel					High alloyed steel, and tool steel				Stainless steel		Grey cast iron		Nodular cast iron		Malleable cast iron
VDI 3323	1	2	3	4	5	6	7	8	9	10	11	12	13	14	15	16	17	18	19	20	
HRc		13	25	28	32	10	29	32	38	15	35	15	23	10	10	26	3	25		21	
HB	125	190	250	270	300	180	275	300	350	200	325	200	240	180	180	260	160	250	130	230	
Recommend	○	○	◎	◎	◎	○	◎	◎	◎	○	◎	○	○	○	○	○	○	○	○	○	
ISO Material Description	N										S							H			
	Aluminum-wrought alloy		Aluminum-cast, alloyed			Copper and Copper Alloys (Bronze / Brass)			Non Metallic Materials		Heat Resistant Super Alloys					Titanium Alloys		Hardened steel	Chilled Cast Iron	Hardened Cast Iron	
VDI 3323	21	22	23	24	25	26	27	28	29	30	31	32	33	34	35	36	37	38	39	40	41
HRc											15	30	25	38	34			55	60	42	55
HB	60	100	75	90	130	110	90	100			200	280	250	350	320	400 Rm	1050 Rm	550	630	400	550
Recommend																		◎	◎	◎	○



4G MILL END MILLS

PLAIN SHANK

SEM845 SERIES

CARBIDE, 2 FLUTE with EXTENDED NECK

- VOLLHARTMETALL, 2 SCHNEIDEN mit ABGESETZTEM SCHAFTTETL
- () Fraise carbure, 2 dents, détalonnée
- () MD, 2 TAGLIENTI, SPIGOLO VIVO, SERIE LUNGA

- ▶ New coating and tool geometry applied resulting outstanding cutting abilities and wear resistance.
- ▶ Excellent for cutting prehardened steels, carbon steels, alloy steels of molds and dies, up to HRC55 and machine parts.
- ▶ For 1.0mm and under 1.0mm diameter size products, it is designed with a double neck to increase tool rigidity and to minimize vibration.
- ▶ Available in several effective lengths of cut and also overall lengths to apply on various rib processing.

- ▶ Aufgrund einer neuartigen Beschichtung und neuer Werkzeuggeometrien hervorragende Schnittleistung und Verschleißfestigkeit
- ▶ Ausgezeichnet geeignet für das Fräsen von vorvergütetem Stahl, kohlenstoff Stahl, legiertem Stahl für Formen, bis HRC55 und Maschinenbauteile.
- ▶ Bei Fräsen mit einem $\phi \leq 1,0\text{mm}$ gewährleistet die "Doppel-Hals-Geometrie" eine erhöhte Werkzeugsteifigkeit und minimiert Vibrationen während der Bearbeitung.
- ▶ Die Auswahl an verschiedenen Effektiv- und Gesamt-Längen der Werkzeuge ermöglicht die Herstellung der verschiedensten Steg- und Rippen-Variationen.

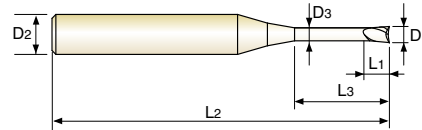

CARBIDE 2 30° PLAIN P.316-325

Unit : mm

EDP No.	Mill Diameter	Shank Diameter	Length of Cut	Length Below Shank	Overall Length	Neck Diameter
	D1	D2	L1	L3	L2	D3
★ SEM84502512E	2.5	4	4	12	50	2.40
SEM84502514E	2.5	4	4	14	50	2.40
★ SEM84502516E	2.5	4	4	16	50	2.40
SEM84502518E	2.5	4	4	18	50	2.40
★ SEM84502520E	2.5	4	4	20	50	2.40
SEM84502522E	2.5	4	4	22	60	2.40
★ SEM84502526E	2.5	4	4	26	60	2.40
SEM84502530E	2.5	4	4	30	70	2.40
SEM84502535E	2.5	4	4	35	70	2.40
SEM84502540E	2.5	4	4	40	80	2.40
SEM84502545E	2.5	4	4	45	90	2.40
SEM84502550E	2.5	4	4	50	100	2.40
★ SEM84503006E	3.0	6	4.5	6	50	2.85
★ SEM84503008E	3.0	6	4.5	8	50	2.85
★ SEM84503010E	3.0	6	4.5	10	50	2.85
★ SEM84503012E	3.0	6	4.5	12	50	2.85
★ SEM84503014E	3.0	6	4.5	14	60	2.85
★ SEM84503016E	3.0	6	4.5	16	60	2.85
★ SEM84503018E	3.0	6	4.5	18	60	2.85
★ SEM84503020E	3.0	6	4.5	20	60	2.85
SEM84503022E	3.0	6	4.5	22	65	2.85
★ SEM84503026E	3.0	6	4.5	26	65	2.85
★ SEM84503030E	3.0	6	4.5	30	70	2.85
★ SEM84503035E	3.0	6	4.5	35	70	2.85

★ : Stock Item

▶ NEXT PAGE

Size	Mill Dia. Tolerance (mm)	Shank Dia. Tolerance
up to $\phi 6$	0 ~ - 0.012	h5
over $\phi 6$	0 ~ - 0.015	

◎ : Excellent ○ : Good

ISO Material Description	P										M				K						
	Non-alloy steel					Low alloy steel					High alloyed steel, and tool steel				Stainless steel		Grey cast iron		Nodular cast iron		Malleable cast iron
VDI 3323	1	2	3	4	5	6	7	8	9	10	11	12	13	14	15	16	17	18	19	20	
HRC		13	25	28	32	10	29	32	38	15	35	15	23	10	10	26	3	25	42	21	
HB	125	190	250	270	300	180	275	300	350	200	325	200	240	180	180	260	160	250	130	230	
Recommend	○	○	◎	◎	◎	○	◎	◎	◎	◎	◎	○	○	○	○	○	○	○	○	○	

ISO Material Description	N										S						H				
	Aluminum-wrought alloy		Aluminum-cast, alloyed			Copper and Copper Alloys (Bronze / Brass)			Non Metallic Materials		Heat Resistant Super Alloys				Titanium Alloys		Hardened steel	Chilled Cast Iron	Hardened Cast Iron		
VDI 3323	21	22	23	24	25	26	27	28	29	30	31	32	33	34	35	36	37	38	39	40	41
HRC											15	30	25	38	34			55	60	42	55
HB	60	100	75	90	130	110	90	100			200	280	250	350	320	400 Rm	1050 Rm	550	630	400	550
Recommend																		○	◎	○	○

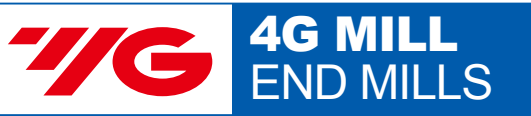

CARBIDE, 2 FLUTE with EXTENDED NECK

- **VOLLHARTMETALL, 2 SCHNEIDEN mit ABGESETZTEM SCHAFTTETTEL**
- **Fraise carbure, 2 dents, détalonnée**
- **MD, 2 TAGLIENTI, SPIGOLO VIVO, SERIE LUNGA**

- ▶ New coating and tool geometry applied resulting outstanding cutting abilities and wear resistance.
- ▶ Excellent for cutting prehardened steels, carbon steels, alloy steels of molds and dies, up to HRC55 and machine parts.
- ▶ For 1.0mm and under 1.0mm diameter size products, it is designed with a double neck to increase tool rigidity and to minimize vibration.
- ▶ Available in several effective lengths of cut and also overall lengths to apply on various rib processing.
- ▶ Aufgrund einer neuartigen Beschichtung und neuer Werkzeuggeometrien hervorragende Schnittleistung und Verschleißfestigkeit
- ▶ Ausgezeichnet geeignet für das Fräsen von vorvergütetem Stahl, kohlenstoff Stahl, legiertem Stahl für Formen, bis HRC55 und Maschinenbauteile.
- ▶ Bei Fräsern mit einem $\phi \leq 1,0\text{mm}$ gewährleistet die "Doppel-Hals-Geometrie" eine erhöhte Werkzeugsteifigkeit und minimiert Vibrationen während der Bearbeitung.
- ▶ Die Auswahl an verschiedenen Effektiv- und Gesamt-Längen der Werkzeuge ermöglicht die Herstellung der verschiedensten Steg- und Rippen-Variationen.

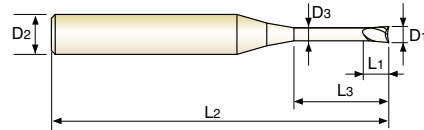

Unit : mm

EDP No.	Mill Diameter	Shank Diameter	Length of Cut	Length Below Shank	Overall Length	Neck Diameter
	D1	D2	L1	L3	L2	D3
★ SEM84503040E	3.0	6	4.5	40	80	2.85
SEM84503045E	3.0	6	4.5	45	90	2.85
SEM84503050E	3.0	6	4.5	50	100	2.85
SEM84503060E	3.0	6	4.5	60	100	2.85
SEM84504008E	4.0	6	6	8	50	3.85
★ SEM84504010E	4.0	6	6	10	50	3.85
★ SEM84504012E	4.0	6	6	12	50	3.85
SEM84504014E	4.0	6	6	14	60	3.85
★ SEM84504016E	4.0	6	6	16	60	3.85
★ SEM84504018E	4.0	6	6	18	60	3.85
★ SEM84504020E	4.0	6	6	20	60	3.85
SEM84504022E	4.0	6	6	22	65	3.85
★ SEM84504026E	4.0	6	6	26	65	3.85
★ SEM84504030E	4.0	6	6	30	70	3.85
★ SEM84504035E	4.0	6	6	35	70	3.85
★ SEM84504040E	4.0	6	6	40	80	3.85
★ SEM84504045E	4.0	6	6	45	90	3.85
SEM84504050E	4.0	6	6	50	100	3.85
SEM84504060E	4.0	6	6	60	100	3.85
SEM84505016E	5.0	6	8	16	60	4.85
★ SEM84505020E	5.0	6	8	20	60	4.85
SEM84505026E	5.0	6	8	26	65	4.85
★ SEM84505030E	5.0	6	8	30	70	4.85
★ SEM84505035E	5.0	6	8	35	75	4.85

★ : Stock Item

▶ NEXT PAGE

Size	Mill Dia. Tolerance (mm)	Shank Dia. Tolerance
up to $\phi 6$	0 ~ - 0.012	h5
over $\phi 6$	0 ~ - 0.015	

◎ : Excellent ○ : Good

ISO Material Description	P										M				K						
	Non-alloy steel					Low alloy steel					High alloyed steel, and tool steel				Stainless steel		Grey cast iron		Nodular cast iron		Malleable cast iron
VDI 3323	1	2	3	4	5	6	7	8	9	10	11	12	13	14	15	16	17	18	19	20	
HRc		13	25	28	32	10	29	32	38	15	35	15	23	10	10	26	3	25		21	
HB	125	190	250	270	300	180	275	300	350	200	325	200	240	180	180	260	160	250	130	230	
Recommend	○	○	◎	◎	◎	○	◎	◎	◎	○	◎	○	○	○	○	○	○	○	○	○	
ISO Material Description	N										S						H				
	Aluminum-wrought alloy		Aluminum-cast, alloyed			Copper and Copper Alloys (Bronze / Brass)			Non Metallic Materials		Heat Resistant Super Alloys				Titanium Alloys		Hardened steel	Chilled Cast Iron	Hardened Cast Iron		
VDI 3323	21	22	23	24	25	26	27	28	29	30	31	32	33	34	35	36	37	38	39	40	41
HRc											15	30	25	38	34			55	60	42	55
HB	60	100	75	90	130	110	90	100			200	280	250	350	320	400 Rm	1050 Rm	550	630	400	550
Recommend																		◎	◎	◎	○

CARBIDE, 2 FLUTE with EXTENDED NECK

- VOLLHARTMETALL, 2 SCHNEIDEN mit ABGESETZTEM SCHAFTTETEL
- Fraise carbure, 2 dents, détalonnée
- MD, 2 TAGLIENTI, SPIGOLO VIVO, SERIE LUNGA

- ▶ New coating and tool geometry applied resulting outstanding cutting abilities and wear resistance.
 - ▶ Excellent for cutting prehardened steels, carbon steels, alloy steels of molds and dies, up to HRC55 and machine parts.
 - ▶ For 1.0mm and under 1.0mm diameter size products, it is designed with a double neck to increase tool rigidity and to minimize vibration.
 - ▶ Available in several effective lengths of cut and also overall lengths to apply on various rib processing.
- ▶ Aufgrund einer neuartigen Beschichtung und neuer Werkzeuggeometrien hervorragende Schnittleistung und Verschleißfestigkeit
 - ▶ Ausgezeichnet geeignet für das Fräsen von vorvergütetem Stahl, kohlenstoff Stahl, legiertem Stahl für Formen, bis HRC55 und Maschinenbauteile.
 - ▶ Bei Fräsern mit einem $\phi \leq 1,0\text{mm}$ gewährleistet die "Doppel-Hals-Geometrie" eine erhöhte Werkzeugsteifigkeit und minimiert Vibrationen während der Bearbeitung.
 - ▶ Die Auswahl an verschiedenen Effektiv- und Gesamt-Längen der Werkzeuge ermöglicht die Herstellung der verschiedensten Steg- und Rippen-Variationen.

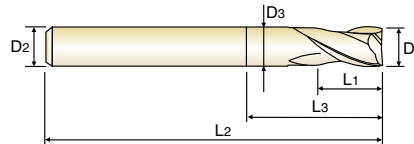

EDP No.	Mill Diameter	Shank Diameter	Length of Cut	Length Below Shank	Overall Length	Neck Diameter
	D1	D2	L1	L3	L2	D3
★ SEM84505040E	5.0	6	8	40	80	4.85
★ SEM84505050E	5.0	6	8	50	90	4.85
SEM84505060E	5.0	6	8	60	100	4.85
★ SEM84506015E	6.0	6	9	15	60	5.85
★ SEM84506020E	6.0	6	9	20	60	5.85
★ SEM84506030E	6.0	6	9	30	70	5.85
★ SEM84506032E	6.0	6	9	32	90	5.85
★ SEM84508025E	8.0	8	12	25	70	7.70
★ SEM84508030E	8.0	8	12	30	80	7.70
★ SEM84508042E	8.0	8	12	42	100	7.70
★ SEM84510030E	10.0	10	15	30	75	9.70
SEM84510035E	10.0	10	15	35	80	9.70
★ SEM84510045E	10.0	10	15	45	100	9.70
★ SEM84512035E	12.0	12	20	35	80	11.70
SEM84512040E	12.0	12	20	40	90	11.70
★ SEM84512050E	12.0	12	20	50	110	11.70

★ : Stock Item

Size	Mill Dia. Tolerance (mm)	Shank Dia. Tolerance
up to $\phi 6$	0 ~ - 0.012	h5
over $\phi 6$	0 ~ - 0.015	

◎ : Excellent ○ : Good

ISO Material Description	P										M				K						
	Non-alloy steel					Low alloy steel					High alloyed steel, and tool steel				Stainless steel		Grey cast iron		Nodular cast iron		Malleable cast iron
VDI 3323	1	2	3	4	5	6	7	8	9	10	11	12	13	14	15	16	17	18	19	20	
HRC		13	25	28	32	10	29	32	38	15	35	15	23	10	10	26	3	25	42	21	
HB	125	190	250	270	300	180	275	300	350	200	325	200	240	180	180	260	160	250	130	230	
Recommend	○	○	◎	◎	◎	○	◎	◎	◎	○	◎	○	○	○	○	○	○	○	○	○	

ISO Material Description	N										S						H				
	Aluminum-wrought alloy		Aluminum-cast, alloyed			Copper and Copper Alloys (Bronze / Brass)			Non Metallic Materials		Heat Resistant Super Alloys						Titanium Alloys		Hardened steel	Chilled Cast Iron	Hardened Cast Iron
VDI 3323	21	22	23	24	25	26	27	28	29	30	31	32	33	34	35	36	37	38	39	40	41
HRC											15	30	25	38	34			55	60	42	55
HB	60	100	75	90	130	110	90	100			200	280	250	350	320	400 Rm	1050 Rm	550	630	400	550
Recommend																		○	◎	○	○

CARBIDE, 4 FLUTE MULTIPLE HELIX

- **VOLLHARTMETALL, 4 SCHNEIDEN MEHRSPIRAL**
- **Fraise carbure, 4 dents, hélice multiple**
- **MD, 4 TAGLIENTI, SPIGOLO VIVO**

- ▶ New coating and tool geometry applied resulting outstanding cutting abilities and wear resistance.
- ▶ Excellent for cutting prehardened steels, carbon steels, alloy steels of molds and dies, up to HRC55 and machine parts.
- ▶ Multiple Helix for 3.0mm and over 3.0mm diameter end mills minimizing vibration and decreasing wear in cutting.

- ▶ Aufgrund einer neuartigen Beschichtung und neuer Werkzeuggeometrien hervorragende Schnittleistung und Verschleißfestigkeit
- ▶ Ausgezeichnet geeignet für das Fräsen von vorvergütetem Stahl, kohlenstoff Stahl, legiertem Stahl für Formen, bis HRC55 und Maschinenbauteile.
- ▶ Aufgrund der Multi-Helix (M-Helix) bei Schafffräsern $\geq 3.0\text{mm}$ \varnothing werden Vibrationen zuverlässig verhindert und gleichzeitig der Schneidkantenverschleiß verringert.

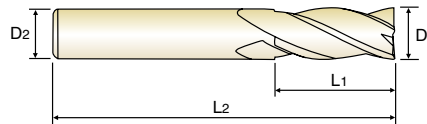

CARBIDE 4 27°/30° PLAIN P.326-329

D< \varnothing 3, 30° HELIX

Unit : mm

EDP No.	Mill Diameter	Shank Diameter	Length of Cut	Overall Length	Remark
	D1	D2	L1	L2	
SEME36008E	0.8	4	1.6	40	4mm Shank
SEME36009E	0.9	4	1.8	40	4mm Shank
SEME360104SE	1.0	4	2.5	50	4mm Shank
★ SEME36010E	1.0	6	2.5	50	-
SEME360124SE	1.2	4	3	50	4mm Shank
SEME36012E	1.2	6	3	50	-
SEME360154SE	1.5	4	4	50	4mm Shank
★ SEME36015E	1.5	6	4	50	-
SEME360204SE	2.0	4	6	50	4mm Shank
★ SEME36020E	2.0	6	6	50	-
SEME360254SE	2.5	4	7	50	4mm Shank
★ SEME36025E	2.5	6	7	50	-
★ SEME36030E	3.0	6	8	50	-
★ SEME36035E	3.5	6	10	50	-
★ SEME36040E	4.0	6	10	50	-
★ SEME36045E	4.5	6	14	50	-
★ SEME36050E	5.0	6	15	60	-
★ SEME36055E	5.5	6	15	60	-
★ SEME36060E	6.0	6	15	60	-
★ SEME36065E	6.5	8	18	60	-
★ SEME36070E	7.0	8	20	60	-
★ SEME36075E	7.5	8	20	60	-
★ SEME36080E	8.0	8	20	70	-
★ SEME36085E	8.5	10	22	70	-

★ : Stock Item

▶ NEXT PAGE

Mill Dia. Tolerance (mm)	Shank Dia. Tolerance
0 ~ - 0.03	h5

◎ : Excellent ○ : Good

ISO Material Description	P											M				K					
	Non-alloy steel					Low alloy steel				High alloyed steel, and tool steel		Stainless steel		Grey cast iron		Nodular cast iron		Malleable cast iron			
VDI 3323	1	2	3	4	5	6	7	8	9	10	11	12	13	14	15	16	17	18	19	20	
HRc		13	25	28	32	10	29	32	38	15	35	15	23	10	10	26	3	25		21	
HB	125	190	250	270	300	180	275	300	350	200	325	200	240	180	180	260	160	250	130	230	
Recommend	○	○	◎	◎	◎	◎	◎	◎	◎	○	◎	○	○	○	○	○	○	○	○	○	
ISO Material Description	N										S							H			
	Aluminum-wrought alloy		Aluminum-cast, alloyed			Copper and Copper Alloys (Bronze / Brass)			Non Metallic Materials		Heat Resistant Super Alloys					Titanium Alloys		Hardened steel	Chilled Cast Iron	Hardened Cast Iron	
VDI 3323	21	22	23	24	25	26	27	28	29	30	31	32	33	34	35	36	37	38	39	40	41
HRc											15	30	25	38	34			55	60	42	55
HB	60	100	75	90	130	110	90	100			200	280	250	350	320	400 Rm	1050 Rm	550	630	400	550
Recommend																		○	◎	◎	○

CARBIDE, 4 FLUTE MULTIPLE HELIX

- VOLLHARTMETALL, 4 SCHNEIDEN MEHRSPIRAL
- (●) Fraise carbure, 4 dents, hélice multiple
- (●) MD, 4 TAGLIENTI, SPIGOLO VIVO

- ▶ New coating and tool geometry applied resulting outstanding cutting abilities and wear resistance.
- ▶ Excellent for cutting prehardened steels, carbon steels, alloy steels of molds and dies, up to HRC55 and machine parts.
- ▶ Multiple Helix for 3.0mm and over 3.0mm diameter end mills minimizing vibration and decreasing wear in cutting.

- ▶ Aufgrund einer neuartigen Beschichtung und neuer Werkzeuggeometrien hervorragende Schnittleistung und Verschleißfestigkeit
- ▶ Ausgezeichnet geeignet für das Fräsen von vorvergütetem Stahl, kohlenstoff Stahl, legiertem Stahl für Formen, bis HRC55 und Maschinenbauteile.
- ▶ Aufgrund der Multi-Helix (M-Helix) bei Schafffräsern $\geq 3,0\text{mm } \phi$ werden Vibrationen zuverlässig verhindert und gleichzeitig der Schneidkantenverschleiß verringert.

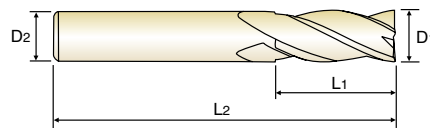

Dϕ3, 30° HELIX

Unit : mm

EDP No.	Mill Diameter	Shank Diameter	Length of Cut	Overall Length	Remark
	D1	D2	L1	L2	
★ SEME36090E	9.0	10	22	70	-
★ SEME36095E	9.5	10	24	70	-
★ SEME36100E	10.0	10	25	75	-
SEME36105E	10.5	12	26	75	-
★ SEME36110E	11.0	12	30	75	-
SEME36115E	11.5	12	30	80	-
★ SEME36120E	12.0	12	30	80	-
SEME36130E	13.0	12	35	100	-
SEME3614012SE	14.0	12	35	100	-
★ SEME3614014SE	14.0	14	35	100	-
★ SEME36140E	14.0	16	35	100	-
SEME36150E	15.0	16	38	100	-
★ SEME36160E	16.0	16	40	100	-
SEME36170E	17.0	16	42	100	-
★ SEME36180E	18.0	16	45	100	-
★ SEME3618018SE	18.0	18	45	100	-
SEME36190E	19.0	20	45	100	-
★ SEME36200E	20.0	20	45	100	-
SEME36210E	21.0	20	45	100	-
SEME36220E	22.0	20	45	100	-
SEME36230E	23.0	25	50	120	-
SEME36240E	24.0	25	50	120	-
SEME36250E	25.0	25	50	120	-

★ : Stock Item

Mill Dia. Tolerance (mm)	Shank Dia. Tolerance
0 ~ - 0.03	h5

◎ : Excellent ○ : Good

ISO Material Description	P										M				K						
	Non-alloy steel					Low alloy steel					High alloyed steel, and tool steel				Stainless steel		Grey cast iron		Nodular cast iron		Malleable cast iron
VDI 3323	1	2	3	4	5	6	7	8	9	10	11	12	13	14	15	16	17	18	19	20	
HRC	13	25	28	32	10	29	32	38	15	35	15	23	10	10	26	3	25	3	25		
HB	125	190	250	270	300	180	275	300	350	200	325	200	240	180	180	260	160	250	130	230	
Recommend	○	○	◎	◎	◎	○	◎	◎	◎	◎	◎	○	○	○	○	○	○	○	○	○	

ISO Material Description	N					S										H					
	Aluminum-wrought alloy		Aluminum-cast, alloyed			Copper and Copper Alloys (Bronze / Brass)			Non Metallic Materials		Heat Resistant Super Alloys					Titanium Alloys		Hardened steel	Chilled Cast Iron	Hardened Cast Iron	
VDI 3323	21	22	23	24	25	26	27	28	29	30	31	32	33	34	35	36	37	38	39	40	41
HRC	15	30	25	38	34	15	30	25	38	34	200	280	250	350	320	400 Rm	1050 Rm	550	630	400	550
HB	60	100	75	90	130	110	90	100										550	630	400	550
Recommend																		○	◎	◎	○

YG 4G MILL END MILLS

PLAIN SHANK

SEME71 SERIES

CARBIDE, 4 FLUTE MULTIPLE HELIX (Sharp corner removal)

- **VOLLHARTMETALL, 4 SCHNEIDEN MEHRSPIRAL (Scharfe Schneidenecken entfernt)**
- **Fraise carbure, 4 dents, hélice multiple (Protection de l'angle d'attaque)**
- **MD, 4 TAGLIENTI, TAGLIENTE RINFORZATO**

- ▶ New coating and tool geometry applied resulting outstanding cutting abilities and wear resistance.
 - ▶ Excellent for cutting prehardened steels, carbon steels, alloy steels of molds and dies, up to HRC55 and machine parts.
 - ▶ Multiple Helix for 3.0mm and over 3.0mm diameter endmills minimizing vibration and decreasing wear in cutting.
 - Equal index flutes design for long length and single helix (38°) end mills.
 - ▶ Gash land geometry applied at the end tooth, achieving heavy duty cutting.
 - ▶ Available various length products like short, regular and long length end mills etc.
 - ▶ Available in short, regular and long shank end mills.
- ▶ Aufgrund einer neuartigen Beschichtung und neuer Werkzeuggeometrien hervorragende Schnittleistung und Verschleißfestigkeit
 - ▶ Ausgezeichnet geeignet für das Fräsen von vorvergütetem Stahl, kohlenstoff Stahl, legiertem Stahl für Formen, bis HRC55 und Maschinenbauteile.
 - ▶ Aufgrund der Multi-Helix (M-Helix) bei Schaffräsern $\geq 3,0\text{mm } \phi$ werden Vibrationen zuverlässig verhindert und gleichzeitig der Schneidkantenverschleiß verringert.
 - Designed mit gleichgeteilten Spannuten für überlange Schaffräser.
 - ▶ Aufgrund der korrigierten Stimschneiden ist eine Schwerzerspannung möglich.
 - ▶ Erhältlich in verschiedenen Variationen: kurz, lang und extra lang.

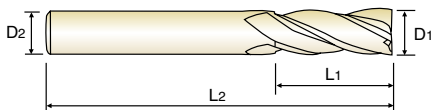

CARBIDE 4 35°/38° PLAIN P.326-329

Dϕ3, Long Length 38° HELIX

Unit : mm

EDP No.	Mill Diameter	Shank Diameter	Length of Cut	Overall Length	Remark
	D1	D2	L1	L2	
SEME71010014SE	1.0	4	1	40	4mm Shank
SEME71010024SE	1.0	4	2	40	4mm Shank
SEME710104SE	1.0	4	2.5	50	4mm Shank
SEME71010034SE	1.0	4	3	50	4mm Shank
SEME71010044SE	1.0	4	4	50	4mm Shank
SEME71010064SE	1.0	4	6	50	4mm Shank
SEME7101001E	1.0	6	1	40	Short
SEME7101002E	1.0	6	2	40	Short
★ SEME71010E	1.0	6	2.5	50	Regular
SEME7101003E	1.0	6	3	50	Long
SEME7101004E	1.0	6	4	50	Long
SEME7101006E	1.0	6	6	50	Long
SEME71012024SE	1.2	4	2	40	4mm Shank
SEME710124SE	1.2	4	3	50	4mm Shank
SEME71012044SE	1.2	4	4	50	4mm Shank
SEME71012064SE	1.2	4	6	50	4mm Shank
SEME7101202E	1.2	6	2	40	Short
★ SEME71012E	1.2	6	3	50	Regular
SEME7101204E	1.2	6	4	50	Long
SEME7101206E	1.2	6	6	50	Long
SEME710150154SE	1.5	4	1.5	40	4mm Shank
SEME71015034SE	1.5	4	3	40	4mm Shank
SEME710154SE	1.5	4	4	50	4mm Shank
SEME71015064SE	1.5	4	6	50	4mm Shank

★ : Stock Item

▶ NEXT PAGE

Mill Dia. Tolerance (mm)	Shank Dia. Tolerance
0 ~ - 0.03	h5

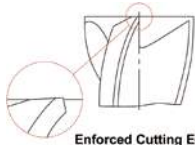

Enforced Cutting Edge

◎ : Excellent ○ : Good

ISO Material Description	P											M				K					
	Non-alloy steel					Low alloy steel				High alloyed steel, and tool steel		Stainless steel				Grey cast iron		Nodular cast iron		Malleable cast iron	
VDI 3323	1	2	3	4	5	6	7	8	9	10	11	12	13	14	15	16	17	18	19	20	
HRc		13	25	28	32	10	29	32	38	15	35	15	23	10	10	26	3	25		21	
HB	125	190	250	270	300	180	275	300	350	200	325	200	240	180	180	260	160	250	130	230	
Recommend	○	○	◎	◎	◎	○	◎	◎	◎	○	◎	○	○	○	○	○	○	○	○	○	
ISO Material Description	N										S							H			
	Aluminum-wrought alloy		Aluminum-cast, alloyed			Copper and Copper Alloys (Bronze / Brass)			Non Metallic Materials		Heat Resistant Super Alloys					Titanium Alloys		Hardened steel	Chilled Cast Iron	Hardened Cast Iron	
VDI 3323	21	22	23	24	25	26	27	28	29	30	31	32	33	34	35	36	37	38	39	40	41
HRc											15	30	25	38	34			55	60	42	55
HB	60	100	75	90	130	110	90	100			200	280	250	350	320	400 Rm	1050 Rm	550	630	400	550
Recommend											○	○	○	○	○	○	○	○	○	◎	○

YG 4G MILL END MILLS

PLAIN SHANK **SEME71** SERIES

CARBIDE, 4 FLUTE MULTIPLE HELIX (Sharp corner removal)

- **VOLLHARTMETALL, 4 SCHNEIDEN MEHRSPIRAL (Scharfe Schneidenecken entfernt)**
- () **Fraise carbure, 4 dents, hélice multiple (Protection de l'angle d'attaque)**
- () **MD, 4 TAGLIENTE, TAGLIENTE RINFORZATO**

- ▶ New coating and tool geometry applied resulting outstanding cutting abilities and wear resistance.
- ▶ Excellent for cutting prehardened steels, carbon steels, alloy steels of molds and dies, up to HRC55 and machine parts.
- ▶ Multiple Helix for 3.0mm and over 3.0mm diameter endmills minimizing vibration and decreasing wear in cutting.
- Equal index flutes design for long length and single helix (38°) end mills.
- ▶ Gash land geometry applied at the end tooth, achieving heavy duty cutting.
- ▶ Available various length products like short, regular and long length end mills etc.
- ▶ Available in short, regular and long shank end mills.

- ▶ Aufgrund einer neuartigen Beschichtung und neuer Werkzeuggeometrien hervorragende Schnittleistung und Verschleißfestigkeit
- ▶ Ausgezeichnet geeignet für das Fräsen von vorvergütetem Stahl, kohlenstoff Stahl, legiertem Stahl für Formen, bis HRC55 und Maschinenbauteile.
- ▶ Aufgrund der Multi-Helix (M-Helix) bei Schaftfräsern $\geq 3,0\text{mm } \phi$ werden Vibrationen zuverlässig verhindert und gleichzeitig der Schneidkantenverschleiß verringert.
- Designed mit gleichgeteilten Spannuten für überlange Schaftfräser.
- ▶ Aufgrund der korrigierten Stirnschneiden ist eine Schwerzerspannung möglich.
- ▶ Erhältlich in verschiedenen Variationen: kurz, lang und extra lang.

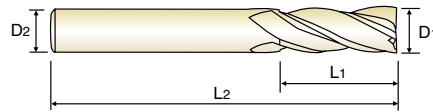

CARBIDE 4 35°/38° PLAIN P.326-329

Dϕ3, Long Length 38° HELIX

Unit : mm

EDP No.	Mill Diameter	Shank Diameter	Length of Cut	Overall Length	Remark
	D1	D2	L1	L2	
SEME71015084SE	1.5	4	8	50	4mm Shank
SEME71015104SE	1.5	4	10	50	4mm Shank
SEME71015015E	1.5	6	1.5	40	Short
SEME7101503E	1.5	6	3	40	Short
★ SEME71015E	1.5	6	4	50	Regular
SEME7101506E	1.5	6	6	50	Long
SEME7101508E	1.5	6	8	50	Long
SEME7101510E	1.5	6	10	50	Long
SEME71020024SE	2.0	4	2	40	4mm Shank
SEME71020044SE	2.0	4	4	40	4mm Shank
SEME710204SE	2.0	4	6	50	4mm Shank
SEME71020084SE	2.0	4	8	50	4mm Shank
SEME71020104SE	2.0	4	10	50	4mm Shank
SEME71020124SE	2.0	4	12	50	4mm Shank
SEME7102002E	2.0	6	2	40	Short
SEME7102004E	2.0	6	4	40	Short
★ SEME71020E	2.0	6	6	50	Regular
SEME7102008E	2.0	6	8	50	Long
SEME7102010E	2.0	6	10	50	Long
SEME7102012E	2.0	6	12	50	Long
SEME710250254SE	2.5	4	2.5	40	4mm Shank
SEME71025054SE	2.5	4	5	40	4mm Shank
SEME710254SE	2.5	4	7	50	4mm Shank
SEME71025104SE	2.5	4	10	50	4mm Shank

★ : Stock Item

▶ NEXT PAGE

Mill Dia. Tolerance (mm)	Shank Dia. Tolerance
0 ~ - 0.03	h5

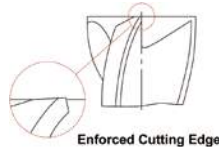

◎ : Excellent ○ : Good

ISO Material Description	P										M				K						
	Non-alloy steel					Low alloy steel					High alloyed steel, and tool steel				Stainless steel		Grey cast iron		Nodular cast iron		Malleable cast iron
VDI 3323	1	2	3	4	5	6	7	8	9	10	11	12	13	14	15	16	17	18	19	20	
HRC	13	25	28	32	10	29	32	38	15	35	15	23	10	10	26	3	25	130	21		
HB	125	190	250	270	300	180	275	300	350	200	325	200	240	180	180	260	160	250	130	230	
Recommend	○	○	◎	◎	◎	○	◎	◎	◎	◎	◎	○	○	○	○	○	○	○	○	○	

ISO Material Description	N										S						H				
	Aluminum-wrought alloy		Aluminum-cast, alloyed			Copper and Copper Alloys (Bronze / Brass)			Non Metallic Materials		Heat Resistant Super Alloys						Titanium Alloys		Hardened steel	Chilled Cast Iron	Hardened Cast Iron
VDI 3323	21	22	23	24	25	26	27	28	29	30	31	32	33	34	35	36	37	38	39	40	41
HRC	15	30	25	38	34	15	30	25	38	34	200	280	250	350	320	400 Rm	1050 Rm	550	630	400	550
HB	60	100	75	90	130	110	90	100													
Recommend																				◎	○

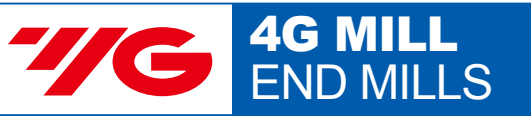

CARBIDE, 4 FLUTE MULTIPLE HELIX (Sharp corner removal)

- **VOLLHARTMETALL, 4 SCHNEIDEN MEHRSPIRAL (Scharfe Schneidenecken entfernt)**
- **Fraise carbure, 4 dents, hélice multiple (Protection de l'angle d'attaque)**
- **MD, 4 TAGLIANTI, TAGLIENTE RINFORZATO**

- ▶ New coating and tool geometry applied resulting outstanding cutting abilities and wear resistance.
- ▶ Excellent for cutting prehardened steels, carbon steels, alloy steels of molds and dies, up to HRC55 and machine parts.
- ▶ Multiple Helix for 3.0mm and over 3.0mm diameter endmills minimizing vibration and decreasing wear in cutting.
 - Equal index flutes design for long length and single helix (38°) end mills.
- ▶ Gash land geometry applied at the end tooth, achieving heavy duty cutting.
- ▶ Available various length products like short, regular and long length end mills etc.
- ▶ Available in short, regular and long shank end mills.

- ▶ Aufgrund einer neuartigen Beschichtung und neuer Werkzeuggeometrien hervorragende Schnittleistung und Verschleißfestigkeit
- ▶ Ausgezeichnet geeignet für das Fräsen von vorvergütetem Stahl, kohlenstoff Stahl, legiertem Stahl für Formen, bis HRC55 und Maschinenbauteile.
- ▶ Aufgrund der Multi-Helix (M-Helix) bei Schafffräsern $\geq 3,0\text{mm } \phi$ werden Vibrationen zuverlässig verhindert und gleichzeitig der Schneidkantenverschleiß verringert.
 - Designed mit gleichgeteilten Spannuten für überlange Schafffräser.
- ▶ Aufgrund der korrigierten Stimschneiden ist eine Scherzerspannung möglich.
- ▶ Erhältlich in verschiedenen Variationen: kurz, lang und extra lang.

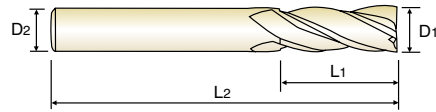

Dϕ3, Long Length 38° HELIX

Unit : mm

EDP No.	Mill Diameter	Shank Diameter	Length of Cut	Overall Length	Remark
	D1	D2	L1	L2	
SEME71025124SE	2.5	4	12	50	4mm Shank
SEME71025025E	2.5	6	2.5	40	Short
SEME7102505E	2.5	6	5	40	Short
★ SEME71025E	2.5	6	7	50	Regular
SEME7102510E	2.5	6	10	50	Long
SEME7102512E	2.5	6	12	50	Long
SEME7103003E	3.0	6	3	40	Short
SEME7103006E	3.0	6	6	40	Short
★ SEME71030E	3.0	6	8	50	Regular
SEME7103010E	3.0	6	10	50	Long
SEME7103012E	3.0	6	12	50	Long
SEME7103014E	3.0	6	14	50	Long
SEME7104004E	4.0	6	4	40	Short
SEME7104008E	4.0	6	8	40	Short
★ SEME71040E	4.0	6	10	50	Regular
SEME7104012E	4.0	6	12	50	Long
SEME7104014E	4.0	6	14	50	Long
SEME7104016E	4.0	6	16	50	Long
SEME7105005E	5.0	6	5	50	Short
SEME7105010E	5.0	6	10	50	Short
★ SEME71050E	5.0	6	15	60	Regular
SEME7105020E	5.0	6	20	60	Long
SEME7105025E	5.0	6	25	60	Long
SEME7106006E	6.0	6	6	50	Short

★ : Stock Item

Mill Dia. Tolerance (mm)	Shank Dia. Tolerance
0 ~ - 0.03	h5

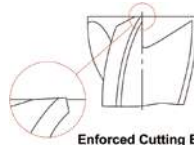

Enforced Cutting Edge

▶ NEXT PAGE

◎ : Excellent ○ : Good

ISO Material Description	P											M				K					
	Non-alloy steel					Low alloy steel				High alloyed steel, and tool steel		Stainless steel		Grey cast iron		Nodular cast iron		Malleable cast iron			
VDI 3323	1	2	3	4	5	6	7	8	9	10	11	12	13	14	15	16	17	18	19	20	
HRc		13	25	28	32	10	29	32	38	15	35	15	23	10	10	26	3	25		21	
HB	125	190	250	270	300	180	275	300	350	200	325	200	240	180	180	260	160	250	130	230	
Recommend	○	○	◎	◎	◎	◎	◎	◎	◎	○	◎	○	○	○	○	○	○	○	○	○	
ISO Material Description	N										S							H			
	Aluminum-wrought alloy		Aluminum-cast, alloyed			Copper and Copper Alloys (Bronze / Brass)			Non Metallic Materials		Heat Resistant Super Alloys					Titanium Alloys		Hardened steel	Chilled Cast Iron	Hardened Cast Iron	
VDI 3323	21	22	23	24	25	26	27	28	29	30	31	32	33	34	35	36	37	38	39	40	41
HRc											15	30	25	38	34			55	60	42	55
HB	60	100	75	90	130	110	90	100			200	280	250	350	320	400 Rm	1050 Rm	550	630	400	550
Recommend											○	○	○	○	○	○	○	○	○	◎	○

YG 4G MILL END MILLS

PLAIN SHANK **SEME71** SERIES

CARBIDE, 4 FLUTE MULTIPLE HELIX (Sharp corner removal)

- **VOLLHARTMETALL, 4 SCHNEIDEN MEHRSPIRAL (Scharfe Schneidenecken entfernt)**
- () **Fraise carbure, 4 dents, hélice multiple (Protection de l'angle d'attaque)**
- () **MD, 4 TAGLIENTI, TAGLIENTE RINFORZATO**

- ▶ New coating and tool geometry applied resulting outstanding cutting abilities and wear resistance.
- ▶ Excellent for cutting prehardened steels, carbon steels, alloy steels of molds and dies, up to HRC55 and machine parts.
- ▶ Multiple Helix for 3.0mm and over 3.0mm diameter endmills minimizing vibration and decreasing wear in cutting.
- Equal index flutes design for long length and single helix (38°) end mills.
- ▶ Gash land geometry applied at the end tooth, achieving heavy duty cutting.
- ▶ Available various length products like short, regular and long length end mills etc.
- ▶ Available in short, regular and long shank end mills.

- ▶ Aufgrund einer neuartigen Beschichtung und neuer Werkzeuggeometrien hervorragende Schnittleistung und Verschleißfestigkeit
- ▶ Ausgezeichnet geeignet für das Fräsen von vorvergütetem Stahl, kohlenstoff Stahl, legiertem Stahl für Formen, bis HRC55 und Maschinenbauteile.
- ▶ Aufgrund der Multi-Helix (M-Helix) bei Schaftfräsern $\geq 3,0\text{mm } \varnothing$ werden Vibrationen zuverlässig verhindert und gleichzeitig der Schneidkantenverschleiß verringert.
- Designed mit gleichgeteilten Spannuten für überlange Schaftfräser.
- ▶ Aufgrund der korrigierten Stirmschneiden ist eine Schwerkraftspannung möglich.
- ▶ Erhältlich in verschiedenen Variationen: kurz, lang und extra lang.

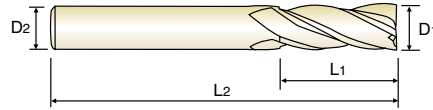

CARBIDE 4 35°/38° PLAIN P.326-329

D\varnothing3, Long Length 38° HELIX

Unit : mm

EDP No.	Mill Diameter	Shank Diameter	Length of Cut	Overall Length	Remark
	D1	D2	L1	L2	
SEME7106012E	6.0	6	12	50	Short
★ SEME71060E	6.0	6	15	60	Regular
SEME7106020E	6.0	6	20	60	Long
SEME7106025E	6.0	6	25	60	Long
SEME7108016E	8.0	8	16	60	Short
★ SEME71080E	8.0	8	20	70	Regular
SEME7108025E	8.0	8	25	70	Long
SEME7108030E	8.0	8	30	70	Long
★ SEME7110022E	10.0	10	22	65	Short
★ SEME71100E	10.0	10	25	75	Regular
★ SEME7110030E	10.0	10	30	75	Long
★ SEME7110035E	10.0	10	35	75	Long
SEME7112026E	12.0	12	26	70	Short
★ SEME71120E	12.0	12	30	80	Regular
★ SEME7112035E	12.0	12	35	80	Long
★ SEME7112040E	12.0	12	40	80	Long
SEME71140E	14.0	16	35	100	Regular
★ SEME7116032E	16.0	16	32	100	Short
★ SEME71160E	16.0	16	40	100	Regular
SEME71180E	18.0	20	45	100	Regular
★ SEME71200E	20.0	20	45	100	Regular

★ : Stock Item

Mill Dia. Tolerance (mm)	Shank Dia. Tolerance
0 ~ - 0.03	h5

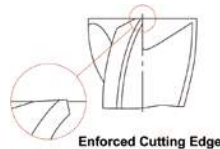

◎ : Excellent ○ : Good

ISO Material Description	P										M				K						
	Non-alloy steel					Low alloy steel					High alloyed steel, and tool steel				Stainless steel		Grey cast iron		Nodular cast iron		Malleable cast iron
VDI 3323	1	2	3	4	5	6	7	8	9	10	11	12	13	14	15	16	17	18	19	20	
HRC	125	13	25	28	32	10	29	32	38	15	35	15	23	10	15	26	3	25	130	21	
HB	190	190	250	270	300	180	275	300	350	200	325	200	240	180	180	260	160	250	130	230	
Recommend	○	○	◎	◎	◎	○	◎	◎	◎	◎	◎	○	○	○	○	○	○	○	○	○	

ISO Material Description	N					S					H											
	Aluminum-wrought alloy		Aluminum-cast, alloyed		Copper and Copper Alloys (Bronze / Brass)	Non Metallic Materials	Heat Resistant Super Alloys			Titanium Alloys		Hardened steel	Chilled Cast Iron	Hardened Cast Iron								
VDI 3323	21	22	23	24	25	26	27	28	29	30	31	32	33	34	35	36	37	38	39	40	41	
HRC	60	100	75	90	130	110	90	100	15	30	25	38	34	31	30	25	38	34	55	60	42	55
HB	60	100	75	90	130	110	90	100	200	280	250	350	320	400 Rm	1050 Rm	550	630	400	550			
Recommend	○	○	○	○	○	○	○	○	○	○	○	○	○	○	○	○	○	○	○	◎	○	

CARBIDE, 4 FLUTE LONG LENGTH

- **VOLLHARTMETALL, 4 SCHNEIDEN LANG**
- **Fraise carbure, 4 dents, longue**
- **MD, 4 TAGLIENTI, SPIGOLO VIVO, SERIE LUNGA**

- ▶ New coating and tool geometry applied resulting outstanding cutting abilities and wear resistance.
- ▶ Excellent for cutting prehardened steels, carbon steels, alloy steels of molds and dies, up to HRC55 and machine parts.
- ▶ Available in short, regular and long shank end mills.

- ▶ Aufgrund einer neuartigen Beschichtung und neuer Werkzeuggeometrien hervorragende Schnittleistung und Verschleißfestigkeit
- ▶ Hervorragende Leistung bei der Zerspaltung von vorvergüteten Stählen bis HRC55, welche im Werkzeug- und Formenbau Verwendung finden.
- ▶ Erhältlich in verschiebenen Schneiden- und Gesamtlängen.

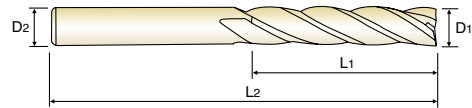

CARBIDE 4 30° PLAIN P.330-335

Unit : mm

EDP No.	Mill Diameter	Shank Diameter	Length of Cut	Overall Length
	D1	D2	L1	L2
★ SEME7201003E	1.0	6	3	60
★ SEME7201004E	1.0	6	4	60
★ SEME7201005E	1.0	6	5	60
★ SEME7201006E	1.0	6	6	60
SEME7201007E	1.0	6	7	60
★ SEME7201008E	1.0	6	8	60
SEME7201010E	1.0	6	10	60
SEME7201012E	1.0	6	12	60
SEME7201204E	1.2	6	4	60
SEME7201206E	1.2	6	6	60
SEME7201208E	1.2	6	8	60
SEME7201210E	1.2	6	10	60
SEME7201212E	1.2	6	12	60
★ SEME7201506E	1.5	6	6	60
★ SEME7201508E	1.5	6	8	60
SEME7201510E	1.5	6	10	60
SEME7201512E	1.5	6	12	60
SEME7201514E	1.5	6	14	60
SEME7201516E	1.5	6	16	60
★ SEME7202008E	2.0	6	8	60
★ SEME7202010E	2.0	6	10	60
★ SEME7202012E	2.0	6	12	60
★ SEME7202014E	2.0	6	14	60
★ SEME7202016E	2.0	6	16	60

★ : Stock Item

▶ NEXT PAGE

Mill Dia. Tolerance (mm)	Shank Dia. Tolerance
0 ~ - 0.03	h5

◎ : Excellent ○ : Good

ISO Material Description	P											M			K					
	Non-alloy steel					Low alloy steel				High alloyed steel, and tool steel		Stainless steel			Grey cast iron		Nodular cast iron		Malleable cast iron	
VDI 3323	1	2	3	4	5	6	7	8	9	10	11	12	13	14	15	16	17	18	19	20
HRc		13	25	28	32	10	29	32	38	15	35	15	23	10	10	26	3	25		21
HB	125	190	250	270	300	180	275	300	350	200	325	200	240	180	180	260	160	250	130	230
Recommend	○	○	◎	◎	◎	◎	◎	◎	◎	○	◎	○	○	○	○	○	○	○	○	○

ISO Material Description	N										S							H			
	Aluminum-wrought alloy		Aluminum-cast, alloyed			Copper and Copper Alloys (Bronze / Brass)			Non Metallic Materials		Heat Resistant Super Alloys					Titanium Alloys		Hardened steel	Chilled Cast Iron	Hardened Cast Iron	
VDI 3323	21	22	23	24	25	26	27	28	29	30	31	32	33	34	35	36	37	38	39	40	41
HRc											15	30	25	38	34			55	60	42	55
HB	60	100	75	90	130	110	90	100			200	280	250	350	320	400 Rm	1050 Rm	550	630	400	550
Recommend																		○	◎	◎	○

CARBIDE, 4 FLUTE LONG LENGTH

- VOLLHARTMETALL, 4 SCHNEIDEN LANG
- Fraise carbure, 4 dents, longue
- MD, 4 TAGLIENTI, SPIGOLO VIVO, SERIE LUNGA

- ▶ New coating and tool geometry applied resulting outstanding cutting abilities and wear resistance.
- ▶ Excellent for cutting prehardened steels, carbon steels, alloy steels of molds and dies, up to HRC55 and machine parts.
- ▶ Available in short, regular and long shank end mills.

- ▶ Aufgrund einer neuartigen Beschichtung und neuer Werkzeuggeometrien hervorragende Schnittleistung und Verschleißfestigkeit
- ▶ Hervorragende Leistung bei der Zerspaltung von vorvergüteten Stählen bis HRC55, welche im Werkzeug- und Formenbau Verwendung finden.
- ▶ Erhältlich in verschiebenen Schneiden- und Gesamtlängen.

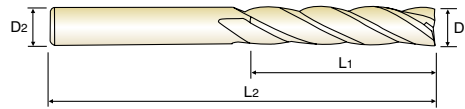

CARBIDE

4

30°

PLAIN

P.330-335

EDP No.	Mill Diameter	Shank Diameter	Length of Cut	Overall Length
	D1	D2	L1	L2
★ SEME7202510E	2.5	6	10	60
★ SEME7202512E	2.5	6	12	60
SEME7202516E	2.5	6	16	60
SEME7202520E	2.5	6	20	60
SEME7202526E	2.5	6	26	60
SEME72030163SE	3.0	3	16	100
★ SEME7203010E	3.0	6	10	70
★ SEME7203012E	3.0	6	12	70
★ SEME7203014E	3.0	6	14	70
★ SEME7203016E	3.0	6	16	70
★ SEME7203020E	3.0	6	20	70
★ SEME7203026E	3.0	6	26	70
★ SEME7203030E	3.0	6	30	70
★ SEME72040204SE	4.0	4	20	100
★ SEME7204012E	4.0	6	12	70
★ SEME7204016E	4.0	6	16	70
★ SEME7204020E	4.0	6	20	70
★ SEME7204026E	4.0	6	26	70
★ SEME7204030E	4.0	6	30	70
★ SEME7205020E	5.0	6	20	70
★ SEME7205025E	5.0	6	25	70
★ SEME7205025100E	5.0	6	25	100
★ SEME7205030E	5.0	6	30	80
★ SEME7205035E	5.0	6	35	90

★ : Stock Item

▶ NEXT PAGE

Mill Dia. Tolerance (mm)	Shank Dia. Tolerance
0 ~ - 0.03	h5

◎ : Excellent ○ : Good

ISO Material Description	P										M			K							
	Non-alloy steel					Low alloy steel					High alloyed steel, and tool steel			Stainless steel			Grey cast iron		Nodular cast iron		Malleable cast iron
VDI 3323	1	2	3	4	5	6	7	8	9	10	11	12	13	14	15	16	17	18	19	20	
HRC	13	25	28	32	10	29	32	38	15	35	15	23	10	10	26	3	25	42	21		
HB	125	190	250	270	300	180	275	300	350	200	325	200	240	180	180	260	160	250	130	230	
Recommend	○	○	◎	◎	◎	○	◎	◎	◎	◎	◎	◎	◎	○	○	○	○	○	○		
ISO Material Description	N										S						H				
	Aluminum-wrought alloy		Aluminum-cast, alloyed			Copper and Copper Alloys (Bronze / Brass)			Non Metallic Materials		Heat Resistant Super Alloys						Titanium Alloys		Hardened steel	Chilled Cast Iron	Hardened Cast Iron
VDI 3323	21	22	23	24	25	26	27	28	29	30	31	32	33	34	35	36	37	38	39	40	41
HRC	21	22	23	24	25	26	27	28	29	30	31	32	33	34	35	36	37	38	39	40	41
HB	60	100	75	90	130	110	90	100			200	280	250	350	320	400 Rm	1050 Rm	550	630	400	550
Recommend																		○	◎	◎	○

CARBIDE, 4 FLUTE LONG LENGTH

- **VOLLHARTMETALL, 4 SCHNEIDEN LANG**
- **Fraise carbure, 4 dents, longue**
- **MD, 4 TAGLIENTI, SPIGOLO VIVO, SERIE LUNGA**

- ▶ New coating and tool geometry applied resulting outstanding cutting abilities and wear resistance.
- ▶ Excellent for cutting prehardened steels, carbon steels, alloy steels of molds and dies, up to HRC55 and machine parts.
- ▶ Available in short, regular and long shank end mills.

- ▶ Aufgrund einer neuartigen Beschichtung und neuer Werkzeuggeometrien hervorragende Schnittleistung und Verschleißfestigkeit
- ▶ Hervorragende Leistung bei der Zerspaltung von vorvergüteten Stählen bis HRC55, welche im Werkzeug- und Formenbau Verwendung finden.
- ▶ Erhältlich in verschiedenen Schneiden- und Gesamtlängen.

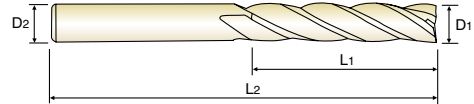

CARBIDE 4 30° PLAIN P.330-335

Unit : mm

EDP No.	Mill Diameter	Shank Diameter	Length of Cut	Overall Length
	D1	D2	L1	L2
★ SEME7205040E	5.0	6	40	100
★ SEME7206015E	6.0	6	15	60
★ SEME7206015080E	6.0	6	15	80
★ SEME7206020E	6.0	6	20	70
★ SEME7206020090E	6.0	6	20	90
★ SEME7206025E	6.0	6	25	75
★ SEME7206030E	6.0	6	30	80
★ SEME7206030100E	6.0	6	30	100
★ SEME7206030150E	6.0	6	30	150
★ SEME7206035E	6.0	6	35	90
★ SEME7206040E	6.0	6	40	90
★ SEME7206040120E	6.0	6	40	120
★ SEME7206045E	6.0	6	45	150
★ SEME7208025E	8.0	8	25	80
★ SEME7208030E	8.0	8	30	80
★ SEME7208030100E	8.0	8	30	100
★ SEME7208035E	8.0	8	35	90
★ SEME7208040E	8.0	8	40	90
★ SEME7208040120E	8.0	8	40	120
★ SEME7208040150E	8.0	8	40	150
★ SEME7208045E	8.0	8	45	100
★ SEME7208050E	8.0	8	50	100
★ SEME7208050150E	8.0	8	50	150
★ SEME7210030E	10.0	10	30	80

★ : Stock Item

▶ NEXT PAGE

Mill Dia. Tolerance (mm)	Shank Dia. Tolerance
0 ~ - 0.03	h5

◎ : Excellent ○ : Good

ISO Material Description	P											M			K						
	Non-alloy steel					Low alloy steel				High alloyed steel, and tool steel		Stainless steel			Grey cast iron		Nodular cast iron		Malleable cast iron		
VDI 3323	1	2	3	4	5	6	7	8	9	10	11	12	13	14	15	16	17	18	19	20	
HRC		13	25	28	32	10	29	32	38	15	35	15	23	10	10	26	3	25		21	
HB	125	190	250	270	300	180	275	300	350	200	325	200	240	180	180	260	160	250	130	230	
Recommend	○	○	◎	◎	◎	○	◎	◎	◎	○	◎	○	○	○	○	○	○	○	○	○	
ISO Material Description	N										S							H			
	Aluminum-wrought alloy		Aluminum-cast, alloyed			Copper and Copper Alloys (Bronze / Brass)			Non Metallic Materials		Heat Resistant Super Alloys					Titanium Alloys		Hardened steel	Chilled Cast Iron	Hardened Cast Iron	
VDI 3323	21	22	23	24	25	26	27	28	29	30	31	32	33	34	35	36	37	38	39	40	41
HRC											15	30	25	38	34			55	60	42	55
HB	60	100	75	90	130	110	90	100			200	280	250	350	320	400 Rm	1050 Rm	550	630	400	550
Recommend																		○	◎	◎	○

CARBIDE, 4 FLUTE LONG LENGTH

- VOLLHARTMETALL, 4 SCHNEIDEN LANG
- Fraise carbure, 4 dents, longue
- MD, 4 TAGLIENTI, SPIGOLO VIVO, SERIE LUNGA

- ▶ New coating and tool geometry applied resulting outstanding cutting abilities and wear resistance.
- ▶ Excellent for cutting prehardened steels, carbon steels, alloy steels of molds and dies, up to HRC55 and machine parts.
- ▶ Available in short, regular and long shank end mills.

- ▶ Aufgrund einer neuartigen Beschichtung und neuer Werkzeuggeometrien hervorragende Schnittleistung und Verschleißfestigkeit
- ▶ Hervorragende Leistung bei der Zerspaltung von vorvergüteten Stählen bis HRC55, welche im Werkzeug- und Formenbau Verwendung finden.
- ▶ Erhältlich in verschiebenen Schneiden- und Gesamtlängen.

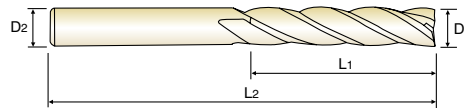

EDP No.	Mill Diameter	Shank Diameter	Length of Cut	Overall Length
	D1	D2	L1	L2
★ SEME7210030100E	10.0	10	30	100
★ SEME7210035E	10.0	10	35	90
★ SEME7210040E	10.0	10	40	90
★ SEME7210040120E	10.0	10	40	120
★ SEME7210045E	10.0	10	45	100
★ SEME7210050E	10.0	10	50	100
★ SEME7210050150E	10.0	10	50	150
SEME7210050200E	10.0	10	50	200
★ SEME7210055E	10.0	10	55	150
★ SEME7210060E	10.0	10	60	110
SEME7210060200E	10.0	10	60	200
★ SEME7212035E	12.0	12	35	90
★ SEME7212040E	12.0	12	40	100
★ SEME7212040120E	12.0	12	40	120
★ SEME7212045E	12.0	12	45	130
★ SEME7212050E	12.0	12	50	100
★ SEME7212050150E	12.0	12	50	150
★ SEME7212055E	12.0	12	55	110
★ SEME7212060E	12.0	12	60	110
★ SEME7212060150E	12.0	12	60	150
SEME7212060200E	12.0	12	60	200
SEME7212065E	12.0	12	65	150
SEME7212070E	12.0	12	70	120
SEME7212070200E	12.0	12	70	200

★ : Stock Item

▶ NEXT PAGE

Mill Dia. Tolerance (mm)	Shank Dia. Tolerance
0 ~ - 0.03	h5

◎ : Excellent ○ : Good

ISO Material Description	P										M			K							
	Non-alloy steel					Low alloy steel					High alloyed steel, and tool steel			Stainless steel			Grey cast iron		Nodular cast iron		Malleable cast iron
VDI 3323	1	2	3	4	5	6	7	8	9	10	11	12	13	14	15	16	17	18	19	20	
HRC		13	25	28	32	10	29	32	38	15	35	15	23	10	10	26	3	25	42	21	
HB	125	190	250	270	300	180	275	300	350	200	325	200	240	180	180	260	160	250	130	230	
Recommend	○	○	◎	◎	◎	○	◎	◎	◎	◎	◎	◎	◎	◎	○	○	○	○	○	○	

ISO Material Description	N					S										H					
	Aluminum-wrought alloy		Aluminum-cast, alloyed			Copper and Copper Alloys (Bronze / Brass)			Non Metallic Materials		Heat Resistant Super Alloys					Titanium Alloys		Hardened steel	Chilled Cast Iron	Hardened Cast Iron	
VDI 3323	21	22	23	24	25	26	27	28	29	30	31	32	33	34	35	36	37	38	39	40	41
HRC											15	30	25	38	34			55	60	42	55
HB	60	100	75	90	130	110	90	100			200	280	250	350	320	400 Rm	1050 Rm	550	630	400	550
Recommend																		○	◎	◎	○

CARBIDE, 4 FLUTE LONG LENGTH

- **VOLLHARTMETALL, 4 SCHNEIDEN LANG**
- **Fraise carbure, 4 dents, longue**
- **MD, 4 TAGLIENTI, SPIGOLO VIVO, SERIE LUNGA**

- ▶ New coating and tool geometry applied resulting outstanding cutting abilities and wear resistance.
- ▶ Excellent for cutting prehardened steels, carbon steels, alloy steels of molds and dies, up to HRC55 and machine parts.
- ▶ Available in short, regular and long shank end mills.

- ▶ Aufgrund einer neuartigen Beschichtung und neuer Werkzeuggeometrien hervorragende Schnittleistung und Verschleißfestigkeit
- ▶ Hervorragende Leistung bei der Zerspaltung von vorvergüteten Stählen bis HRC55, welche im Werkzeug- und Formenbau Verwendung finden.
- ▶ Erhältlich in verschiebenen Schneiden- und Gesamtlängen.

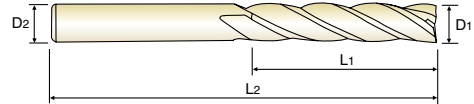

CARBIDE 4 30° PLAIN P.330-335

Unit : mm

EDP No.	Mill Diameter	Shank Diameter	Length of Cut	Overall Length
	D1	D2	L1	L2
★ SEME7214050E	14.0	16	50	110
★ SEME7214060E	14.0	16	60	150
SEME7216040E	16.0	16	40	150
★ SEME7216050E	16.0	16	50	110
SEME7216050150E	16.0	16	50	150
★ SEME7216060E	16.0	16	60	120
★ SEME7216070E	16.0	16	70	130
★ SEME7216070150E	16.0	16	70	150
SEME7216070200E	16.0	16	70	200
SEME7216080E	16.0	16	80	150
SEME7216090E	16.0	16	90	150
SEME72160110E	16.0	16	110	200
SEME72160120E	16.0	16	120	250
SEME7218050E	18.0	20	50	120
SEME7218070E	18.0	20	70	130
SEME72180100E	18.0	20	100	200
★ SEME7220050E	20.0	20	50	110
SEME7220050150E	20.0	20	50	150
★ SEME7220060E	20.0	20	60	130
★ SEME7220070E	20.0	20	70	130
SEME7220080E	20.0	20	80	150
★ SEME7220090E	20.0	20	90	150
★ SEME7220090200E	20.0	20	90	200
SEME72200110E	20.0	20	110	200

★ : Stock Item

▶ NEXT PAGE

Mill Dia. Tolerance (mm)	Shank Dia. Tolerance
0 ~ - 0.03	h5

◎ : Excellent ○ : Good

ISO Material Description	P										M			K							
	Non-alloy steel					Low alloy steel					High alloyed steel, and tool steel			Stainless steel			Grey cast iron		Nodular cast iron		Malleable cast iron
VDI 3323	1	2	3	4	5	6	7	8	9	10	11	12	13	14	15	16	17	18	19	20	
HRc		13	25	28	32	10	29	32	38	15	35	15	23	10	10	26	3	25		21	
HB	125	190	250	270	300	180	275	300	350	200	325	200	240	180	180	260	160	250	130	230	
Recommend	○	○	◎	◎	◎	○	◎	◎	◎	○	◎	○	○	○	○	○	○	○	○	○	
ISO Material Description	N										S						H				
	Aluminum-wrought alloy		Aluminum-cast, alloyed			Copper and Copper Alloys (Bronze / Brass)			Non Metallic Materials		Heat Resistant Super Alloys						Titanium Alloys		Hardened steel	Chilled Cast Iron	Hardened Cast Iron
VDI 3323	21	22	23	24	25	26	27	28	29	30	31	32	33	34	35	36	37	38	39	40	41
HRc											15	30	25	38	34			55	60	42	55
HB	60	100	75	90	130	110	90	100			200	280	250	350	320	400 Rm	1050 Rm	550	630	400	550
Recommend																		○	◎	◎	○

CARBIDE, 4 FLUTE LONG LENGTH

- VOLLHARTMETALL, 4 SCHNEIDEN LANG
- Fraise carbure, 4 dents, longue
- MD, 4 TAGLIENTI, SPIGOLO VIVO, SERIE LUNGA

- ▶ New coating and tool geometry applied resulting outstanding cutting abilities and wear resistance.
- ▶ Excellent for cutting prehardened steels, carbon steels, alloy steels of molds and dies, up to HRC55 and machine parts.
- ▶ Available in short, regular and long shank end mills.

- ▶ Aufgrund einer neuartigen Beschichtung und neuer Werkzeuggeometrien hervorragende Schnittleistung und Verschleißfestigkeit
- ▶ Hervorragende Leistung bei der Zerspaltung von vorvergüteten Stählen bis HRC55, welche im Werkzeug- und Formenbau Verwendung finden.
- ▶ Erhältlich in verschiebenen Schneiden- und Gesamtlängen.

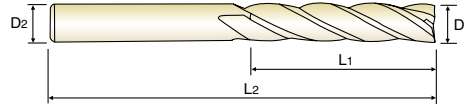

CARBIDE 4 30° PLAIN P.330-335

Unit : mm

EDP No.	Mill Diameter	Shank Diameter	Length of Cut	Overall Length
	D1	D2	L1	L2
★ SEME72200120E	20.0	20	120	250
SEME7222075E	22.0	20	75	150
SEME72220110E	22.0	20	110	200
SEME7225070E	25.0	25	70	150
★ SEME7225090E	25.0	25	90	150
SEME72250110E	25.0	25	110	200
SEME72250120E	25.0	25	120	250

★ : Stock Item

Mill Dia. Tolerance (mm)	Shank Dia. Tolerance
0 ~ - 0.03	h5

◎ : Excellent ○ : Good

ISO Material Description	P										M			K							
	Non-alloy steel					Low alloy steel					High alloyed steel, and tool steel			Stainless steel			Grey cast iron		Nodular cast iron		Malleable cast iron
VDI 3323	1	2	3	4	5	6	7	8	9	10	11	12	13	14	15	16	17	18	19	20	
HRC	13	19	25	28	32	10	29	32	38	15	35	15	23	10	10	26	3	25	42	21	
HB	125	190	250	270	300	180	275	300	350	200	325	200	240	180	180	260	160	250	130	230	
Recommend	○	○	◎	◎	◎	○	◎	◎	◎	○	◎				○	○	○	○	○	○	
ISO Material Description	N					S										H					
	Aluminum-wrought alloy		Aluminum-cast, alloyed			Copper and Copper Alloys (Bronze / Brass)			Non Metallic Materials		Heat Resistant Super Alloys					Titanium Alloys		Hardened steel	Chilled Cast Iron	Hardened Cast Iron	
VDI 3323	21	22	23	24	25	26	27	28	29	30	31	32	33	34	35	36	37	38	39	40	41
HRC											15	30	25	38	34			55	60	42	55
HB	60	100	75	90	130	110	90	100			200	280	250	350	320	400 Rm	1050 Rm	550	630	400	550
Recommend																		○	◎	○	○

CARBIDE, 4 FLUTE with EXTENDED NECK

- **VOLLHARTMETALL, 4 SCHNEIDEN mit ABGESETZTEM SCHAFTTETTEL**
- **Fraise carbure, 4 dents, détalonnée**
- **MD, 4 TAGLIENTI, SCARICATA, SPIGOLO VIVO**

- ▶ New coating and tool geometry applied resulting outstanding cutting abilities and wear resistance.
- ▶ Excellent for cutting prehardened steels, carbon steels, alloy steels of molds and dies, up to HRC55 and machine parts.
- ▶ Available in several effective lengths of cut and also overall lengths than previous standard products.

- ▶ Aufgrund einer neuartigen Beschichtung und neuer Werkzeuggeometrien hervorragende Schnittleistung und Verschleißfestigkeit
- ▶ Hervorragende Leistung bei der Zerspaltung von vorvergüteten Stählen bis HRC55, welche im Werkzeug- und Formenbau Verwendung finden.
- ▶ Erhältlich in verschiedenen gesamt Längen und effektiv Längen. Mehr Auswahlmöglichkeiten als bei den bisherigen standard Produkten.

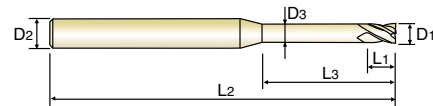

CARBIDE 4 30° PLAIN P.336-341

Unit : mm

EDP No.	Mill Diameter	Shank Diameter	Length of Cut	Length Below Shank	Overall Length	Neck Diameter
	D1	D2	L1	L3	L2	D3
SEME7301002E	1.0	4	1.5	2	50	0.95
SEME7301003E	1.0	4	1.5	3	50	0.95
★ SEME7301004E	1.0	4	1.5	4	50	0.95
★ SEME7301005E	1.0	4	1.5	5	50	0.95
★ SEME7301006E	1.0	4	1.5	6	50	0.95
SEME7301007E	1.0	4	1.5	7	50	0.95
★ SEME7301008E	1.0	4	1.5	8	50	0.95
★ SEME7301010E	1.0	4	1.5	10	50	0.95
★ SEME7301012E	1.0	4	1.5	12	50	0.95
SEME7301014E	1.0	4	1.5	14	50	0.95
SEME7301016E	1.0	4	1.5	16	50	0.95
SEME7301018E	1.0	4	1.5	18	50	0.95
SEME7301020E	1.0	4	1.5	20	50	0.95
SEME7301022E	1.0	4	1.5	22	60	0.95
SEME7301026E	1.0	4	1.5	26	60	0.95
SEME7301030E	1.0	4	1.5	30	70	0.95
SEME7301040E	1.0	4	1.5	40	80	0.95
SEME7301050E	1.0	4	1.5	50	100	0.95
SEME7301204E	1.2	4	1.8	4	50	1.15
SEME7301206E	1.2	4	1.8	6	50	1.15
SEME7301208E	1.2	4	1.8	8	50	1.15
SEME7301210E	1.2	4	1.8	10	50	1.15
SEME7301212E	1.2	4	1.8	12	50	1.15
SEME7301214E	1.2	4	1.8	14	50	1.15

★ : Stock Item

▶ NEXT PAGE

Mill Dia. Tolerance (mm)	Shank Dia. Tolerance
0 ~ - 0.03	h5

◎ : Excellent ○ : Good

ISO Material Description	P										M				K						
	Non-alloy steel					Low alloy steel					High alloyed steel, and tool steel		Stainless steel		Grey cast iron		Nodular cast iron		Malleable cast iron		
VDI 3323	1	2	3	4	5	6	7	8	9	10	11	12	13	14	15	16	17	18	19	20	
HRc		13	25	28	32	10	29	32	38	15	35	15	23	10	10	26	3	25		21	
HB	125	190	250	270	300	180	275	300	350	200	325	200	240	180	180	260	160	250	130	230	
Recommend	○	○	◎	◎	◎	○	◎	◎	◎	○	◎	○	○	○	○	○	○	○	○	○	
ISO Material Description	N										S							H			
	Aluminum-wrought alloy		Aluminum-cast, alloyed			Copper and Copper Alloys (Bronze / Brass)			Non Metallic Materials		Heat Resistant Super Alloys					Titanium Alloys		Hardened steel	Chilled Cast Iron	Hardened Cast Iron	
VDI 3323	21	22	23	24	25	26	27	28	29	30	31	32	33	34	35	36	37	38	39	40	41
HRc											15	30	25	38	34			55	60	42	55
HB	60	100	75	90	130	110	90	100			200	280	250	350	320	400 Rm	1050 Rm	550	630	400	550
Recommend											○	◎	◎	◎	◎	◎	◎	◎	◎	◎	◎



4G MILL END MILLS

PLAIN SHANK

SEME73 SERIES

CARBIDE, 4 FLUTE with EXTENDED NECK

- VOLLHARTMETALL, 4 SCHNEIDEN mit ABGESETZTEM SCHAFTTETEL
- Fraise carbure, 4 dents, détalonnée
- MD, 4 TAGLIENTI, SCARICATA, SPIGOLO VIVO

- ▶ New coating and tool geometry applied resulting outstanding cutting abilities and wear resistance.
- ▶ Excellent for cutting prehardened steels, carbon steels, alloy steels of molds and dies, up to HRc55 and machine parts.
- ▶ Available in several effective lengths of cut and also overall lengths than previous standard products.

- ▶ Aufgrund einer neuartigen Beschichtung und neuer Werkzeuggeometrien hervorragende Schnittleistung und Verschleißfestigkeit
- ▶ Hervorragende Leistung bei der Zerspaltung von vorvergüteten Stählen bis HRc55, welche im Werkzeug- und Formenbau Verwendung finden.
- ▶ Erhältlich in verschiedenen gesamt Längen und effektiv Längen. Mehr Auswahlmöglichkeiten als bei den bisherigen standard Produkten.

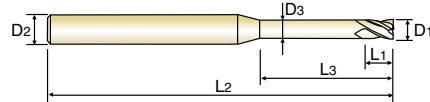

CARBIDE 4 30° PLAIN P.336-341

EDP No.	Mill Diameter	Shank Diameter	Length of Cut	Length Below Shank	Overall Length	Neck Diameter
	D1	D2	L1	L3	L2	D3
SEME7301216E	1.2	4	1.8	16	50	1.15
SEME7301220E	1.2	4	1.8	20	50	1.15
SEME7301226E	1.2	4	1.8	26	60	1.15
SEME7301230E	1.2	4	1.8	30	70	1.15
SEME7301504E	1.5	4	2.3	4	50	1.45
SEME7301505E	1.5	4	2.3	5	50	1.45
★ SEME7301506E	1.5	4	2.3	6	50	1.45
SEME7301507E	1.5	4	2.3	7	50	1.45
★ SEME7301508E	1.5	4	2.3	8	50	1.45
★ SEME7301510E	1.5	4	2.3	10	50	1.45
★ SEME7301512E	1.5	4	2.3	12	50	1.45
SEME7301514E	1.5	4	2.3	14	50	1.45
★ SEME7301516E	1.5	4	2.3	16	50	1.45
SEME7301518E	1.5	4	2.3	18	50	1.45
SEME7301520E	1.5	4	2.3	20	50	1.45
SEME7301522E	1.5	4	2.3	22	60	1.45
SEME7301526E	1.5	4	2.3	26	60	1.45
SEME7301530E	1.5	4	2.3	30	70	1.45
★ SEME7302006E	2.0	4	3	6	50	1.95
★ SEME7302008E	2.0	4	3	8	50	1.95
★ SEME7302010E	2.0	4	3	10	50	1.95
★ SEME7302012E	2.0	4	3	12	50	1.95
★ SEME7302014E	2.0	4	3	14	50	1.95
★ SEME7302016E	2.0	4	3	16	50	1.95

★ : Stock Item

▶ NEXT PAGE

Mill Dia. Tolerance (mm)	Shank Dia. Tolerance
0 ~ - 0.03	h5

◎ : Excellent ○ : Good

ISO Material Description	P										M				K						
	Non-alloy steel					Low alloy steel					High alloyed steel, and tool steel				Stainless steel		Grey cast iron		Nodular cast iron		Malleable cast iron
VDI 3323	1	2	3	4	5	6	7	8	9	10	11	12	13	14	15	16	17	18	19	20	
HRc	125	13	25	28	32	10	29	32	38	15	35	15	23	10	10	26	3	25	42	21	
HB	190	190	250	270	300	180	275	300	350	200	325	200	240	180	180	260	160	250	130	230	
Recommend	○	○	◎	◎	◎	○	◎	◎	◎	◎	◎	○	○	○	○	○	○	○	○	○	

ISO Material Description	N										S						H				
	Aluminum-wrought alloy		Aluminum-cast, alloyed			Copper and Copper Alloys (Bronze / Brass)			Non Metallic Materials		Heat Resistant Super Alloys						Titanium Alloys		Hardened steel	Chilled Cast Iron	Hardened Cast Iron
VDI 3323	21	22	23	24	25	26	27	28	29	30	31	32	33	34	35	36	37	38	39	40	41
HRc	60	100	75	90	130	110	90	100			15	30	25	38	34	400 Rm	1050 Rm	550	630	400	550
Recommend											○	○	○	○	○	○	○	○	◎	○	○

CARBIDE, 4 FLUTE with EXTENDED NECK

- **VOLLHARTMETALL, 4 SCHNEIDEN mit ABGESETZTEM SCHAFTTETL**
- **Fraise carbure, 4 dents, détalonnée**
- **MD, 4 TAGLIENTI, SCARICATA, SPIGOLO VIVO**

- ▶ New coating and tool geometry applied resulting outstanding cutting abilities and wear resistance.
- ▶ Excellent for cutting prehardened steels, carbon steels, alloy steels of molds and dies, up to HRC55 and machine parts.
- ▶ Available in several effective lengths of cut and also overall lengths than previous standard products.

- ▶ Aufgrund einer neuartigen Beschichtung und neuer Werkzeuggeometrien hervorragende Schnittleistung und Verschleißfestigkeit
- ▶ Hervorragende Leistung bei der Zerspaltung von vorvergüteten Stählen bis HRC55, welche im Werkzeug- und Formenbau Verwendung finden.
- ▶ Erhältlich in verschiedenen gesamt Längen und effektiv Längen. Mehr Auswahlmöglichkeiten als bei den bisherigen standard Produkten.

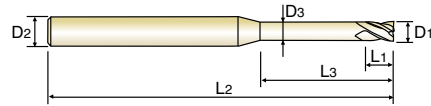

CARBIDE 4 30° PLAIN P.336-341

Unit : mm

EDP No.	Mill Diameter	Shank Diameter	Length of Cut	Length Below Shank	Overall Length	Neck Diameter
	D1	D2	L1	L3	L2	D3
SEME7302018E	2.0	4	3	18	50	1.95
★ SEME7302020E	2.0	4	3	20	50	1.95
SEME7302022E	2.0	4	3	22	60	1.95
★ SEME7302026E	2.0	4	3	26	60	1.95
SEME7302030E	2.0	4	3	30	70	1.95
SEME7302035E	2.0	4	3	35	70	1.95
SEME7302040E	2.0	4	3	40	80	1.95
SEME7302045E	2.0	4	3	45	90	1.95
SEME7302050E	2.0	4	3	50	100	1.95
SEME7302060E	2.0	4	3	60	110	1.95
SEME7302508E	2.5	4	4	8	50	2.40
★ SEME7302510E	2.5	4	4	10	50	2.40
★ SEME7302512E	2.5	4	4	12	50	2.40
SEME7302514E	2.5	4	4	14	50	2.40
SEME7302516E	2.5	4	4	16	50	2.40
SEME7302518E	2.5	4	4	18	50	2.40
SEME7302520E	2.5	4	4	20	50	2.40
SEME7302522E	2.5	4	4	22	60	2.40
SEME7302526E	2.5	4	4	26	60	2.40
SEME7302530E	2.5	4	4	30	70	2.40
SEME7302535E	2.5	4	4	35	70	2.40
SEME7302540E	2.5	4	4	40	80	2.40
SEME7302545E	2.5	4	4	45	90	2.40
SEME7302550E	2.5	4	4	50	100	2.40
SEME7303006E	3.0	6	4.5	6	50	2.85
★ SEME7303008E	3.0	6	4.5	8	50	2.85

★ : Stock Item

▶ NEXT PAGE

Mill Dia. Tolerance (mm)	Shank Dia. Tolerance
0 ~ - 0.03	h5

◎ : Excellent ○ : Good

ISO Material Description	P										M				K						
	Non-alloy steel					Low alloy steel					High alloyed steel, and tool steel		Stainless steel		Grey cast iron		Nodular cast iron		Malleable cast iron		
VDI 3323	1	2	3	4	5	6	7	8	9	10	11	12	13	14	15	16	17	18	19	20	
HRc		13	25	28	32	10	29	32	38	15	35	15	23	10	10	26	3	25		21	
HB	125	190	250	270	300	180	275	300	350	200	325	200	240	180	180	260	160	250	130	230	
Recommend	○	○	◎	◎	◎	○	◎	◎	◎	○	◎	○	○	○	○	○	○	○	○	○	
ISO Material Description	N										S						H				
	Aluminum-wrought alloy		Aluminum-cast, alloyed			Copper and Copper Alloys (Bronze / Brass)			Non Metallic Materials		Heat Resistant Super Alloys				Titanium Alloys		Hardened steel	Chilled Cast Iron	Hardened Cast Iron		
VDI 3323	21	22	23	24	25	26	27	28	29	30	31	32	33	34	35	36	37	38	39	40	41
HRc											15	30	25	38	34			55	60	42	55
HB	60	100	75	90	130	110	90	100			200	280	250	350	320	400 Rm	1050 Rm	550	630	400	550
Recommend	○	○	○	○	○	○	○	○	○	○	○	○	○	○	○	○	○	○	○	◎	○



4G MILL END MILLS

PLAIN SHANK

SEME73 SERIES

CARBIDE, 4 FLUTE with EXTENDED NECK

- VOLLHARTMETALL, 4 SCHNEIDEN mit ABGESETZTEM SCHAFTTETEL
- () Fraise carbure, 4 dents, détalonnée
- () MD, 4 TAGLIENTI, SCARICATA, SPIGOLO VIVO

- ▶ New coating and tool geometry applied resulting outstanding cutting abilities and wear resistance.
- ▶ Excellent for cutting prehardened steels, carbon steels, alloy steels of molds and dies, up to HRC55 and machine parts.
- ▶ Available in several effective lengths of cut and also overall lengths than previous standard products.

- ▶ Aufgrund einer neuartigen Beschichtung und neuer Werkzeuggeometrien hervorragende Schnittleistung und Verschleißfestigkeit
- ▶ Hervorragende Leistung bei der Zerspaltung von vorvergüteten Stählen bis HRC55, welche im Werkzeug- und Formenbau Verwendung finden.
- ▶ Erhältlich in verschiedenen gesamt Längen und effektiv Längen. Mehr Auswahlmöglichkeiten als bei den bisherigen standard Produkten.

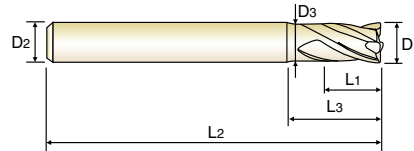

Unit : mm

EDP No.	Mill Diameter	Shank Diameter	Length of Cut	Length Below Shank	Overall Length	Neck Diameter
	D1	D2	L1	L3	L2	D3
★ SEME7303010E	3.0	6	4.5	10	50	2.85
SEME7303012E	3.0	6	4.5	12	50	2.85
★ SEME7303014E	3.0	6	4.5	14	60	2.85
SEME7303016E	3.0	6	4.5	16	60	2.85
★ SEME7303018E	3.0	6	4.5	18	60	2.85
SEME7303020E	3.0	6	4.5	20	60	2.85
★ SEME7303022E	3.0	6	4.5	22	65	2.85
★ SEME7303026E	3.0	6	4.5	26	65	2.85
SEME7303030E	3.0	6	4.5	30	70	2.85
SEME7303035E	3.0	6	4.5	35	70	2.85
SEME7303040E	3.0	6	4.5	40	80	2.85
SEME7303045E	3.0	6	4.5	45	90	2.85
SEME7303050E	3.0	6	4.5	50	100	2.85
SEME7303060E	3.0	6	4.5	60	100	2.85
SEME7304008E	4.0	6	6	8	50	3.85
★ SEME7304010E	4.0	6	6	10	50	3.85
SEME7304012E	4.0	6	6	12	50	3.85
★ SEME7304014E	4.0	6	6	14	60	3.85
SEME7304016E	4.0	6	6	16	60	3.85
★ SEME7304018E	4.0	6	6	18	60	3.85
SEME7304020E	4.0	6	6	20	60	3.85
★ SEME7304022E	4.0	6	6	22	65	3.85
SEME7304025E	4.0	6	6	25	65	3.85
★ SEME7304026E	4.0	6	6	26	65	3.85
SEME7304030E	4.0	6	6	30	70	3.85
★ SEME7304035E	4.0	6	6	35	70	3.85

★ : Stock Item

▶ NEXT PAGE

Mill Dia. Tolerance (mm)	Shank Dia. Tolerance
0 ~ - 0.03	h5

◎ : Excellent ○ : Good

ISO Material Description	P										M				K					
	Non-alloy steel					Low alloy steel					High alloyed steel, and tool steel		Stainless steel		Grey cast iron		Nodular cast iron		Malleable cast iron	
VDI 3323	1	2	3	4	5	6	7	8	9	10	11	12	13	14	15	16	17	18	19	20
HRC																				
HB	125	190	250	270	300	180	275	300	350	200	325	200	240	180	180	260	160	250	130	230
Recommend	○	○	◎	◎	◎	○	◎	◎	◎	◎	◎	○	○	○	○	○	○	○	○	○

ISO Material Description	N										S						H				
	Aluminum-wrought alloy		Aluminum-cast, alloyed			Copper and Copper Alloys (Bronze / Brass)			Non Metallic Materials		Heat Resistant Super Alloys						Titanium Alloys		Hardened steel	Chilled Cast Iron	Hardened Cast Iron
VDI 3323	21	22	23	24	25	26	27	28	29	30	31	32	33	34	35	36	37	38	39	40	41
HRC																					
HB	60	100	75	90	130	110	90	100			200	280	250	350	320	400 Rm	1050 Rm	550	630	400	550
Recommend																		○	◎	◎	○

YG 4G MILL END MILLS

PLAIN SHANK

SEME73 SERIES

CARBIDE, 4 FLUTE with EXTENDED NECK

- **VOLLHARTMETALL, 4 SCHNEIDEN mit ABGESETZTEM SCHAFTTETL**
- **Fraise carbure, 4 dents, détalonnée**
- **MD, 4 TAGLIENTI, SCARICATA, SPIGOLO VIVO**

- ▶ New coating and tool geometry applied resulting outstanding cutting abilities and wear resistance.
- ▶ Excellent for cutting prehardened steels, carbon steels, alloy steels of molds and dies, up to HRC55 and machine parts.
- ▶ Available in several effective lengths of cut and also overall lengths than previous standard products.

- ▶ Aufgrund einer neuartigen Beschichtung und neuer Werkzeuggeometrien hervorragende Schnittleistung und Verschleißfestigkeit
- ▶ Hervorragende Leistung bei der Zerspaltung von vorvergüteten Stählen bis HRC55, welche im Werkzeug- und Formenbau Verwendung finden.
- ▶ Erhältlich in verschiedenen gesamt Längen und effektiv Längen. Mehr Auswahlmöglichkeiten als bei den bisherigen standard Produkten.

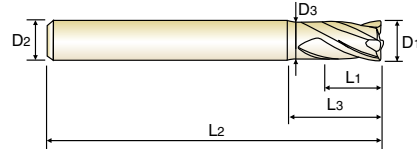

CARBIDE 4 30° PLAIN P.336-341

Unit : mm

EDP No.	Mill Diameter	Shank Diameter	Length of Cut	Length Below Shank	Overall Length	Neck Diameter
	D1	D2	L1	L3	L2	D3
SEME7304040E	4.0	6	6	40	80	3.85
SEME7304045E	4.0	6	6	45	90	3.85
SEME7304050E	4.0	6	6	50	100	3.85
SEME7304060E	4.0	6	6	60	100	3.85
★ SEME7305016E	5.0	6	8	16	60	4.85
SEME7305020E	5.0	6	8	20	60	4.85
SEME7305026E	5.0	6	8	26	65	4.85
SEME7305030E	5.0	6	8	30	70	4.85
★ SEME7305035E	5.0	6	8	35	75	4.85
SEME7305040E	5.0	6	8	40	80	4.85
SEME7305050E	5.0	6	8	50	90	4.85
★ SEME7305060E	5.0	6	8	60	100	4.85
★ SEME7306015E	6.0	6	9	15	60	5.85
★ SEME7306020E	6.0	6	9	20	60	5.85
★ SEME7306030E	6.0	6	9	30	70	5.85
★ SEME7306032E	6.0	6	9	32	90	5.85
SEME7308025E	8.0	8	12	25	70	7.70
★ SEME7308030E	8.0	8	12	30	80	7.70
★ SEME7308042E	8.0	8	12	42	100	7.70
SEME7310030E	10.0	10	15	30	75	9.70
★ SEME7310035E	10.0	10	15	35	80	9.70
★ SEME7310045E	10.0	10	15	45	100	9.70
SEME7312035E	12.0	12	20	35	80	11.70
★ SEME7312040E	12.0	12	20	40	90	11.70
SEME7312050E	12.0	12	20	50	110	11.70

★ : Stock Item

Mill Dia. Tolerance (mm)	Shank Dia. Tolerance
0 ~ - 0.03	h5

◎ : Excellent ○ : Good

ISO Material Description	P										M				K						
	Non-alloy steel					Low alloy steel					High alloyed steel, and tool steel		Stainless steel		Grey cast iron		Nodular cast iron		Malleable cast iron		
VDI 3323	1	2	3	4	5	6	7	8	9	10	11	12	13	14	15	16	17	18	19	20	
HRc		13	25	28	32	10	29	32	38	15	35	15	23	10	10	26	3	25		21	
HB	125	190	250	270	300	180	275	300	350	200	325	200	240	180	180	260	160	250	130	230	
Recommend	○	○	◎	◎	◎	○	◎	◎	◎	○	◎	○	○	○	○	○	○	○	○	○	
ISO Material Description	N										S						H				
	Aluminum-wrought alloy		Aluminum-cast, alloyed			Copper and Copper Alloys (Bronze / Brass)			Non Metallic Materials		Heat Resistant Super Alloys				Titanium Alloys		Hardened steel	Chilled Cast Iron	Hardened Cast Iron		
VDI 3323	21	22	23	24	25	26	27	28	29	30	31	32	33	34	35	36	37	38	39	40	41
HRc											15	30	25	38	34			55	60	42	55
HB	60	100	75	90	130	110	90	100			200	280	250	350	320	400 Rm	1050 Rm	550	630	400	550
Recommend																		○	◎	◎	○

YG 4G MILL END MILLS

PLAIN SHANK **SEME75** SERIES

CARBIDE, 6 FLUTE 45° HELIX (Regular, Long Shank)

- VOLLHARTMETALL, 6 SCHNEIDEN 45° RECHTSSPIRALE
- () Fraise carbure, 6 dents, hélice 45°
- () MD, 6 TAGLIENTI, ELICA 45°, SPIGOLO VIVO (Serie media e lunga)

- ▶ New coating and tool geometry applied resulting outstanding cutting abilities and wear resistance.
- ▶ Excellent performance when cutting prehardened steels, up to HRC55 which are used for molds & dies.
- ▶ From the 45 helix angle, better surface roughness can be achieved at side cutting.
- ▶ Available in several effective lengths of cut and also overall lengths

- ▶ Aufgrund einer neuartigen Beschichtung und neuer Werkzeuggeometrien hervorragende Schnittleistung und Verschleißfestigkeit
- ▶ Hervorragende Leistung bei der Zerspaltung von vorvergüteten Stählen bis HRC55, welche im Werkzeug- und Formenbau Verwendung finden.
- ▶ Aufgrund der 45° Spirale werden bessere Oberflächengüten bei der Eckbearbeitung erreicht
- ▶ Erhältlich in verschiedenen gesamt Längen und effektiv Längen.

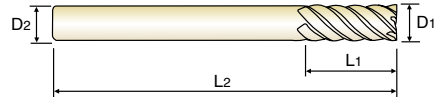

CARBIDE 6 45° PLAIN P.342-343

Unit : mm

EDP No.	Mill Diameter	Shank Diameter	Length of Cut	Overall Length	Remark
	D1	D2	L1	L2	
★ SEME75060E	6.0	6	15	60	Regular
SEME7506020E	6.0	6	20	70	Long
★ SEME7506030E	6.0	6	30	80	Long
SEME7506030110E	6.0	6	30	110	Long
★ SEME75080E	8.0	8	20	70	Regular
★ SEME7508030E	8.0	8	30	80	Long
SEME7508035E	8.0	8	35	90	Long
★ SEME7508040E	8.0	8	40	90	Long
SEME7508040130E	8.0	8	40	130	Long
★ SEME75100E	10.0	10	25	75	Regular
SEME7510030E	10.0	10	30	80	Long
★ SEME7510040E	10.0	10	40	90	Long
SEME7510050E	10.0	10	50	100	Long
SEME7510050150E	10.0	10	50	150	Long
★ SEME75120E	12.0	12	30	80	Regular
★ SEME7512040E	12.0	12	40	90	Long
★ SEME7512050E	12.0	12	50	100	Long
SEME7512060E	12.0	12	60	110	Long
SEME7512060150E	12.0	12	60	150	Long
★ SEME75160E	16.0	16	40	100	Regular
SEME7516050E	16.0	16	50	110	Long
★ SEME7516060E	16.0	16	60	120	Long
SEME7516090E	16.0	16	90	150	Long
SEME75160110E	16.0	16	110	200	Long

★ : Stock Item

▶ NEXT PAGE

Mill Dia. Tolerance (mm)	Shank Dia. Tolerance
0 ~ - 0.03	h5

◎ : Excellent ○ : Good

ISO Material Description	P										M			K							
	Non-alloy steel					Low alloy steel					High alloyed steel, and tool steel			Stainless steel			Grey cast iron		Nodular cast iron		Malleable cast iron
VDI 3323	1	2	3	4	5	6	7	8	9	10	11	12	13	14	15	16	17	18	19	20	
HRC	13	25	28	32	10	29	32	38	15	35	15	23	10	10	26	3	25	13	21		
HB	125	190	250	270	300	180	275	300	350	200	325	200	240	180	180	260	160	250	130	230	
Recommend	○	○	◎	◎	◎	○	◎	◎	◎	◎	◎	◎	◎	○	○	○	○	○	○		

ISO Material Description	N					S					H										
	Aluminum-wrought alloy		Aluminum-cast, alloyed			Copper and Copper Alloys (Bronze / Brass)			Non Metallic Materials		Heat Resistant Super Alloys			Titanium Alloys		Hardened steel	Chilled Cast Iron	Hardened Cast Iron			
VDI 3323	21	22	23	24	25	26	27	28	29	30	31	32	33	34	35	36	37	38	39	40	41
HRC	15	30	25	38	34	15	30	25	38	34	200	280	250	350	320	400 Rm	1050 Rm	550	630	400	550
HB	60	100	75	90	130	110	90	100													
Recommend																		○	◎	◎	○

CARBIDE, 6 FLUTE 45° HELIX (Regular, Long Shank)

- **VOLLHARTMETALL, 6 SCHNEIDEN 45° RECHTSSPIRALE**
- **Fraise carbure, 6 dents, hélice 45°**
- **MD, 6 TAGLIANTI, ELICA 45°, SPIGOLO VIVO (Serie media e lunga)**

- ▶ New coating and tool geometry applied resulting outstanding cutting abilities and wear resistance.
- ▶ Excellent performance when cutting prehardened steels, up to HRC55 which are used for molds & dies.
- ▶ From the 45 helix angle, better surface roughness can be achieved at side cutting.
- ▶ Available in several effective lengths of cut and also overall lengths

- ▶ Aufgrund einer neuartigen Beschichtung und neuer Werkzeuggeometrien hervorragende Schnittleistung und Verschleißfestigkeit
- ▶ Hervorragende Leistung bei der Zerspaltung von vorvergüteten Stählen bis HRC55, welche im Werkzeug- und Formenbau Verwendung finden.
- ▶ Aufgrund der 45° Spirale werden bessere Oberflächengüten bei der Eckbearbeitung erreicht
- ▶ Erhältlich in verschiedenen gesamt Längen und effektiv Längen.

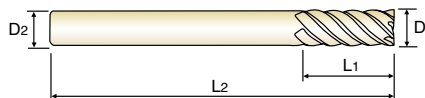

P.342-343

Unit : mm

EDP No.	Mill Diameter	Shank Diameter	Length of Cut	Overall Length	Remark
	D1	D2	L1	L2	
SEME75160110250E	16.0	16	110	250	Long
★ SEME75200E	20.0	20	45	100	Regular
★ SEME7520060E	20.0	20	60	120	Long
SEME7520070E	20.0	20	70	130	Long
SEME75200110E	20.0	20	110	200	Long
SEME75200110250E	20.0	20	110	250	Long
SEME75200110300E	20.0	20	110	300	Long

★ : Stock Item

▶ NEXT PAGE

Mill Dia. Tolerance (mm)	Shank Dia. Tolerance
0 ~ - 0.03	h5

◎ : Excellent ○ : Good

ISO Material Description	P											M			K						
	Non-alloy steel					Low alloy steel				High alloyed steel, and tool steel		Stainless steel			Grey cast iron		Nodular cast iron	Malleable cast iron			
VDI 3323	1	2	3	4	5	6	7	8	9	10	11	12	13	14	15	16	17	18	19	20	
HRc	13	25	28	32	10	29	32	38	15	35	15	23	10	10	26	3	25	130	230		
HB	125	190	250	270	300	180	275	300	350	200	325	200	240	180	180	260	160	250	130	230	
Recommend	○	○	◎	◎	◎	○	◎	◎	◎	○	◎	○	○	○	○	○	○	○	○	○	
ISO Material Description	N										S						H				
	Aluminum-wrought alloy		Aluminum-cast, alloyed			Copper and Copper Alloys (Bronze / Brass)			Non Metallic Materials		Heat Resistant Super Alloys						Titanium Alloys		Hardened steel	Chilled Cast Iron	Hardened Cast Iron
VDI 3323	21	22	23	24	25	26	27	28	29	30	31	32	33	34	35	36	37	38	39	40	41
HRc	21	22	23	24	25	26	27	28	29	30	15	30	25	38	34	400 Rm	1050 Rm	55	60	42	55
HB	60	100	75	90	130	110	90	100			200	280	250	350	320	400 Rm	1050 Rm	550	630	400	550
Recommend																		○	◎	◎	○

CARBIDE, 4&5 FLUTE MULTIPLE HELIX CORNER RADIUS

- **VOLLHARTMETALL, 4&5 SCHNEIDEN MEHRSPIRAL Fräser KURZ ECKENRADIUS**
- **Fraise carbure, 4&5 dents, torique, hélice multiple, courte**
- **MD, 4 & 5 TAGLIANTI, TORICA, SERIE CORTA**

- ▶ Unique flute design for excellent chip evacuation and vibration reduction.
- ▶ Optimal roughing tooth profile to reduce cutting forces.
- ▶ Special tool geometry for high feed rate and heavy cutting.
- ▶ Strong end tooth design for plunge and pocket milling.
- ▶ Custom engineered coating to allow long tool life and excellent chip evacuation.

- ▶ einzigartige Nutengeometrie für hervorragenden Späntransport und Vibrationsreduzierung
- ▶ neuartiges Schruppprofil zur Reduzierung der Schnittkräfte
- ▶ Spezielle Werkzeuggeometrie für Hochvorschub- und Schwerzerspannung geeignet
- ▶ speziell entwickelte Schneidengeometrie für Tauch- und Taschenfräsen
- ▶ YG-1 eigene Beschichtung um lange Lebensdauer und sehr guten Späntransport zu gewährleisten

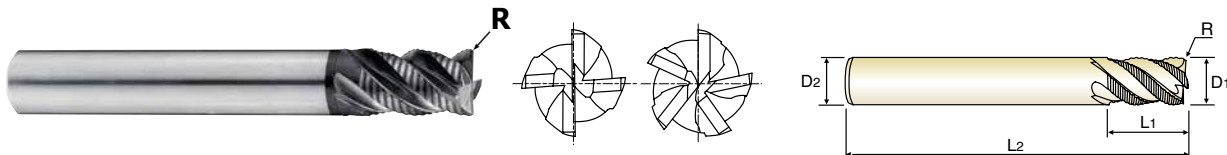

SHORT LENGTH

EDP No.		Corner Radius	Mill Diameter	Shank Diameter	Length of Cut	Overall Length	No. of Flute
PLAIN	FLAT	R	D1	D2	L1	L2	
G9D75060	G9D67060	R0.5	6.0	6	9	57	4
G9D75080	G9D67080	R0.5	8.0	8	12	63	4
G9D75100	G9D67100	R0.5	10.0	10	15	72	4
G9D75120	G9D67120	R0.5	12.0	12	18	83	4
G9D75160	G9D67160	R1.0	16.0	16	24	92	5
G9D75200	G9D67200	R1.0	20.0	20	30	104	5

LONG LENGTH

EDP No.		Corner Radius	Mill Diameter	Shank Diameter	Length of Cut	Overall Length	No. of Flute
PLAIN	FLAT	R	D1	D2	L1	L2	
G9D76060	G9D68060	R0.5	6.0	6	12	57	4
G9D76080	G9D68080	R0.5	8.0	8	16	63	4
G9D76100	G9D68100	R0.5	10.0	10	20	72	4
G9D76120	G9D68120	R0.5	12.0	12	24	83	4
G9D76160	G9D68160	R1.0	16.0	16	32	92	5
G9D76200	G9D68200	R1.0	20.0	20	40	104	5

Mill Dia. Tolerance (mm)	Shank Dia. Tolerance
0 ~ - 0.05	h5

ISO Material Description	P										M					K						
	Non-alloy steel					Low alloy steel					High alloyed steel, and tool steel					Stainless steel			Grey cast iron		Nodular cast iron	
VDI 3323	1	2	3	4	5	6	7	8	9	10	11	12	13	14	15	16	17	18	19	20		
HRc	13	25	28	32	10	29	32	38	15	35	23	10	10	26	3	25	130	21	21			
HB	125	190	250	270	300	180	275	300	350	200	325	200	240	180	180	260	160	250	130	230		
Recommend	○	○	◎	◎	◎	○	◎	◎	◎	○	◎	○	○	○	◎	◎	◎	◎	◎	◎		

ISO Material Description	N					S										H					
	Aluminum-wrought alloy		Aluminum-cast, alloyed			Copper and Copper Alloys (Bronze / Brass)			Non Metallic Materials		Heat Resistant Super Alloys					Titanium Alloys		Hardened steel	Chilled Cast Iron	Hardened Cast Iron	
VDI 3323	21	22	23	24	25	26	27	28	29	30	31	32	33	34	35	36	37	38	39	40	41
HRc	60	100	75	90	130	110	90	100			15	30	25	38	34	55	60	42	55	42	55
HB	60	100	75	90	130	110	90	100			200	280	250	350	320	400 Rm	1050 Rm	550	630	400	550
Recommend						○	○	○													

◎ : Excellent ○ : Good

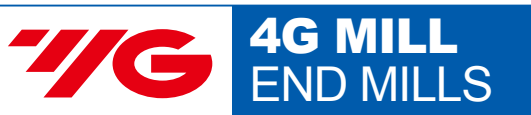

PLAIN SHANK

G9D77 SERIES

FLAT SHANK

G9D69 SERIES

CARBIDE, 4&5 FLUTE MULTIPLE HELIX LONG REACH CORNER RADIUS

● **VOLLHARTMETALL, 4&5 SCHNEIDEN MEHRSPIRAL Fräser GROÙE REICHWEITE ECKENRADIUS**
 ● **Fraise carbure, 4&5 dents, torique longue portée, hélice multiple**
 ● **MD, 4 & 5 TAGLIENTI, TORICA, SCARICATA, SERIE LUNGS**

- ▶ Unique flute design for excellent chip evacuation and vibration reduction.
- ▶ Optimal roughing tooth profile to reduce cutting forces.
- ▶ Special tool geometry for high feed rate and heavy cutting.
- ▶ Strong end tooth design for plunge and pocket milling.
- ▶ Custom engineered coating to allow long tool life and excellent chip evacuation.

- ▶ einzigartige Nutengeometrie für hervorragenden Spántransport und Vibrationsreduzierung
- ▶ neuartiges Schruppprofil zur Reduzierung der Schnittkräfte
- ▶ Spezielle Werkzeuggeometrie für Hochvorschub- und Schwerzerspannung geeignet
- ▶ speziell entwickelte Schneidengeometrie für Tauch- und Taschenfrásen
- ▶ YG-1 eigene Beschichtung um lange Lebensdauer und sehr guten Spántransport zu gewährleisten

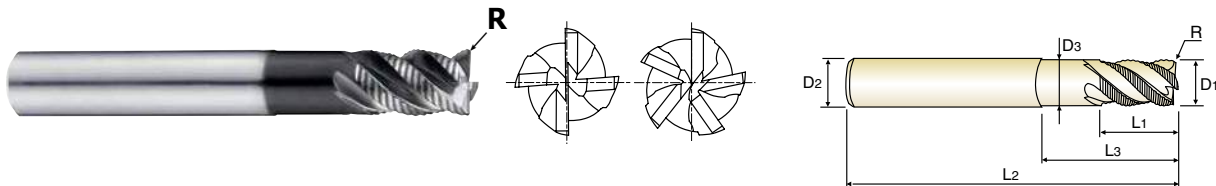

Unit : mm

EDP No.		Corner Radius	Mill Diameter	Shank Diameter	Length of Cut	Length Below Shank	Overall Length	Neck Diameter	No. of Flute
PLAIN	FLAT	R	D1	D2	L1	L3	L2	D3	
G9D77060	G9D69060	R0.5	6.0	6	9	18	57	5.50	4
G9D77080	G9D69080	R0.5	8.0	8	12	24	63	7.50	4
G9D77100	G9D69100	R0.5	10.0	10	15	30	72	9.50	4
G9D77120	G9D69120	R0.5	12.0	12	18	36	83	11.50	4
G9D77160	G9D69160	R1.0	16.0	16	24	48	100	15.50	5
G9D77200	G9D69200	R1.0	20.0	20	30	60	110	19.20	5

Mill Dia. Tolerance (mm)	Shank Dia. Tolerance
0 ~ - 0.05	h5

◎ : Excellent ○ : Good

ISO Material Description	P											M				K					
	Non-alloy steel					Low alloy steel				High alloy steel, and tool steel		Stainless steel		Grey cast iron		Nodular cast iron		Malleable cast iron			
VDI 3323	1	2	3	4	5	6	7	8	9	10	11	12	13	14	15	16	17	18	19	20	
HRc		13	25	28	32	10	29	32	38	15	35	15	23	10	10	26	3	25		21	
HB	125	190	250	270	300	180	275	300	350	200	325	200	240	180	180	260	160	250	130	230	
Recommend	○	○	◎	◎	◎	○	◎	◎	◎	○	◎	○	○	○	◎	◎	◎	◎	◎	◎	
ISO Material Description	N										S						H				
	Aluminum-wrought alloy		Aluminum-cast, alloyed			Copper and Copper Alloys (Bronze / Brass)		Non Metallic Materials			Heat Resistant Super Alloys			Titanium Alloys			Hardened steel	Chilled Cast Iron	Hardened Cast Iron		
VDI 3323	21	22	23	24	25	26	27	28	29	30	31	32	33	34	35	36	37	38	39	40	41
HRc											15	30	25	38	34			55	60	42	55
HB	60	100	75	90	130	110	90	100			200	280	250	350	320	400 Rm	1050 Rm	550	630	400	550
Recommend						○	○	○													

HSS-PM, 4&5 FLUTE MULTIPLE HELIX SHORT LENGTH CORNER RADIUS

- HSS-PM, 4&5 SCHNEIDEN MEHRSPIRAL FRÄSER KURZ ECKENRADIUS
- Fraise HSS-PM, 4&5 dents, torique, hélice multiple, courte
- HSS-PM, 4 & 5 TAGLIENTI, TORICA, SERIE CORTA

- ▶ Unique flute design for excellent chip evacuation and vibration reduction.
- ▶ Optimal roughing tooth profile to reduce cutting forces.
- ▶ Special tool geometry for high feed rate and heavy cutting.
- ▶ Strong end tooth design for plunge and pocket milling.
- ▶ Custom engineered coating to allow long tool life and excellent chip evacuation.

- ▶ einzigartige Nutengeometrie für hervorragenden Spänentransport und Vibrationsreduzierung
- ▶ neuartiges Schruppprofil zur Reduzierung der Schnittkräfte
- ▶ Spezielle Werkzeuggeometrie für Hochvorschub- und Schwerzerspannung geeignet
- ▶ speziell entwickelte Schneidengeometrie für Tauch- und Taschenfräsen
- ▶ eigene Beschichtung um lange Lebensdauer und sehr guten Spänentransport zu gewährleisten

Only available till stock runs out

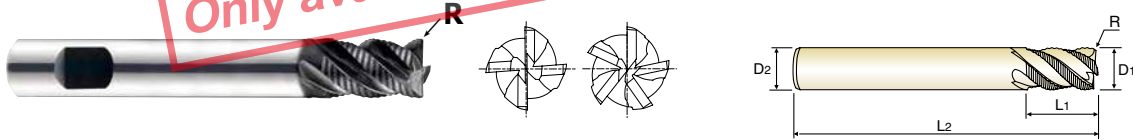

HSS PM

4&5

44°~45°

FLAT

P.345

Unit : mm						
EDP No.	Corner Radius	Mill Diameter	Shank Diameter	Length of Cut	Overall Length	No. of Flute
FLAT	R	D1(js12)	D2(h6)	L1	L2	
▲ GAE53060	R0.5	6.0	6	13	57	4
▲ GAE53070	R0.5	7.0	10	16	66	4
▲ GAE53080	R0.5	8.0	10	19	69	4
▲ GAE53090	R0.5	9.0	10	19	69	4
▲ GAE53100	R0.5	10.0	10	22	72	4
▲ GAE53120	R0.5	12.0	12	26	83	4
▲ GAE53140	R1.0	14.0	16	26	83	5
▲ GAE53160	R1.0	16.0	16	32	92	5
▲ GAE53180	R1.0	18.0	20	32	92	5
▲ GAE53200	R1.0	20.0	20	38	104	5

▲ : Only available till stock runs out

Tolerances according to DIN 7160 & 7161

Tolerance range in μm						
Nominal-Diameter in mm						
	from 1 to 3	over 3 to 6	over 6 to 10	over 10 to 18	over 18 to 30	over 30 to 50
js12	± 50	± 60	± 75	± 90	± 105	± 125
h6	0 -6	0 -8	0 -9	0 -11	0 -13	0 -16

ISO Material Description	P										M					K									
	Non-alloy steel					Low alloy steel					High alloyed steel, and tool steel					Stainless steel			Grey cast iron		Nodular cast iron		Malleable cast iron		
VDI 3323	1	2	3	4	5	6	7	8	9	10	11	12	13	14	15	16	17	18	19	20	21	22	23	24	25
HRC	125	130	135	140	145	150	155	160	165	170	175	180	185	190	195	200	205	210	215	220	225	230	235	240	245
HB	125	130	135	140	145	150	155	160	165	170	175	180	185	190	195	200	205	210	215	220	225	230	235	240	245
Recommend	○	○	○	○	○	○	○	○	○	○	○	○	○	○	○	○	○	○	○	○	○	○	○	○	○

ISO Material Description	N										S						H							
	Aluminum-wrought alloy		Aluminum-cast, alloyed			Copper and Copper Alloys (Bronze / Brass)			Non Metallic Materials		Heat Resistant Super Alloys						Titanium Alloys		Hardened steel	Chilled Cast Iron	Hardened Cast Iron			
VDI 3323	21	22	23	24	25	26	27	28	29	30	31	32	33	34	35	36	37	38	39	40	41	42	43	44
HRC	60	65	70	75	80	85	90	95	100	105	110	115	120	125	130	135	140	145	150	155	160	165	170	175
HB	60	65	70	75	80	85	90	95	100	105	110	115	120	125	130	135	140	145	150	155	160	165	170	175
Recommend	○	○	○	○	○	○	○	○	○	○	○	○	○	○	○	○	○	○	○	○	○	○	○	○

◎ : Excellent ○ : Good

YG 4G MILL END MILLS

RECOMMENDED CUTTING CONDITIONS EMPFOHLENE SCHNEIDPARAMETER

SEMD98 SERIES 2 FLUTE BALL NOSE

Vc = m/min.
fz = mm/tooth
RPM = rev./min.
FEED = mm/min.

ISO	VDI 3323	Material Description	Ae	Ap	Parameter	Diameter (Ø)																
						0.1	0.2	0.3	0.4	0.5	0.6	0.7	0.8	0.9	1.0	1.2	1.5	2.0	2.5			
P	1-5	Non-alloy steel	0.08D	0.05D	Vc	13	19	28	38	47	57	66	75	85	94	113	141	187	187			
					fz	0.007	0.012	0.015	0.019	0.024	0.029	0.034	0.039	0.044	0.048	0.051	0.054	0.057	0.074			
					RPM	41380	30239	29709	30239	29921	30239	30012	29842	30063	29921	29974	29921	29762	23810			
	6-8	Low alloy steel	0.08D	0.05D	Vc	13	19	28	38	47	57	66	75	85	94	113	141	187	187			
					fz	0.007	0.012	0.015	0.019	0.024	0.029	0.034	0.039	0.044	0.048	0.051	0.054	0.057	0.074			
					RPM	41380	30239	29709	30239	29921	30239	30012	29842	30063	29921	29974	29921	29762	23810			
	9	Low alloy steel	0.08D	0.05D	Vc	13	19	28	38	47	57	66	75	85	94	109	136	180	180			
					fz	0.006	0.011	0.014	0.017	0.021	0.025	0.029	0.033	0.038	0.042	0.045	0.047	0.05	0.066			
					RPM	41380	30239	29709	30239	29921	30239	30012	29842	30063	29921	28913	28860	28648	22918			
	10-11.1	High alloyed steel, and tool steel	0.08D	0.05D	Vc	13	19	28	38	47	57	66	75	85	94	113	141	187	187			
					fz	0.007	0.012	0.015	0.019	0.024	0.029	0.034	0.039	0.044	0.048	0.051	0.054	0.057	0.074			
					RPM	41380	30239	29709	30239	29921	30239	30012	29842	30063	29921	29974	29921	29762	23810			
11.2	High alloyed steel, and tool steel	0.08D	0.05D	Vc	13	19	28	38	47	57	66	75	85	94	109	136	180	180				
				fz	0.006	0.011	0.014	0.017	0.021	0.025	0.029	0.033	0.038	0.042	0.045	0.047	0.05	0.066				
				RPM	41380	30239	29709	30239	29921	30239	30012	29842	30063	29921	28913	28860	28648	22918				
K	15-20	Grey cast iron Nodular cast iron Malleable cast iron	0.08D	0.05D	Vc	13	19	28	38	47	57	66	75	85	94	113	141	187	187			
					fz	0.007	0.012	0.015	0.019	0.024	0.029	0.034	0.039	0.044	0.048	0.051	0.054	0.057	0.074			
					RPM	41380	30239	29709	30239	29921	30239	30012	29842	30063	29921	29974	29921	29762	23810			
H	38.1 - 38.2	Hardened steel	0.08D	0.05D	Vc	10	17	25	34	42	51	59	68	76	85	97	122	151	151			
					fz	0.006	0.011	0.013	0.017	0.021	0.024	0.029	0.033	0.038	0.042	0.045	0.047	0.05	0.063			
					RPM	31831	27056	26526	27056	26738	27056	26829	27056	26880	27056	25730	25889	24032	19226			
H	40	Chilled Cast Iron	0.08D	0.05D	Vc	13	19	28	38	47	57	66	75	85	94	109	136	180	180			
					fz	0.006	0.011	0.014	0.017	0.021	0.025	0.029	0.033	0.038	0.042	0.045	0.047	0.05	0.066			
					RPM	41380	30239	29709	30239	29921	30239	30012	29842	30063	29921	28913	28860	28648	22918			
H	41	Hardened Cast Iron	0.08D	0.05D	Vc	10	17	25	34	42	51	59	68	76	85	97	122	151	151			
					fz	0.006	0.011	0.013	0.017	0.021	0.024	0.029	0.033	0.038	0.042	0.045	0.047	0.05	0.063			
					RPM	31831	27056	26526	27056	26738	27056	26829	27056	26880	27056	25730	25889	24032	19226			

▶ NEXT PAGE

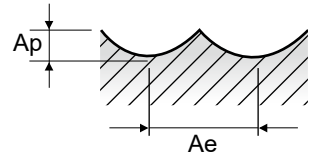

RECOMMENDED CUTTING CONDITIONS
EMPFOHLENE SCHNEIDPARAMETER

Vc = m/min.
fz = mm/tooth
RPM = rev./min.
FEED = mm/min.

SEMD98 SERIES **2 FLUTE BALL NOSE**

VDI 3323	Parameter	Diameter (Ø)																					
		3.0	3.5	4.0	4.5	5.0	5.5	6.0	6.5	7.0	8.0	8.5	9.0	10.0	11.0	12.0	13.0	14.0	15.0	16.0	18.0	20.0	25.0
1-5	Vc	187	187	187	184	175	168	157	159	159	167	168	168	175	168	157	162	165	167	168	170	168	167
	fz	0.091	0.106	0.121	0.136	0.156	0.164	0.174	0.179	0.184	0.189	0.192	0.195	0.199	0.205	0.212	0.218	0.224	0.23	0.238	0.25	0.264	0.27
	RPM	19841	17007	14881	13015	11141	9723	8329	7786	7230	6645	6291	5942	5570	4861	4165	3967	3752	3544	3342	3006	2674	2126
6-8	FEED	3611	3605	3601	3540	3476	3189	2899	2788	2661	2512	2416	2317	2217	1993	1766	1729	1681	1630	1591	1503	1412	1148
	Vc	187	187	187	184	175	168	157	159	159	167	168	168	175	168	157	162	165	167	168	170	168	167
	fz	0.091	0.106	0.111	0.126	0.136	0.144	0.156	0.164	0.174	0.179	0.184	0.189	0.192	0.195	0.199	0.205	0.212	0.218	0.224	0.23	0.238	0.25
9	RPM	19841	17007	14881	13015	11141	9723	8329	7786	7230	6645	6291	5942	5570	4861	4165	3967	3752	3544	3342	3006	2674	2126
	FEED	3611	3605	3601	3540	3476	3189	2899	2788	2661	2512	2416	2317	2217	1993	1766	1729	1681	1630	1591	1503	1412	1148
	Vc	180	180	180	177	168	162	152	153	153	161	162	161	168	161	151	155	158	160	161	164	162	162
10	fz	0.083	0.097	0.111	0.122	0.138	0.144	0.153	0.156	0.159	0.164	0.167	0.17	0.174	0.18	0.188	0.197	0.208	0.221	0.206	0.215	0.227	0.231
	RPM	19099	16370	14324	12520	10695	9376	8064	7493	6957	6406	6067	5694	5348	4659	4005	3795	3592	3395	3203	2900	2578	2063
	FEED	3170	3176	3180	3055	2952	2700	2468	2338	2212	2101	2026	1936	1861	1677	1506	1495	1494	1501	1320	1247	1171	953
11.1	Vc	187	187	187	184	175	168	157	159	159	167	168	168	175	168	157	162	165	167	168	170	168	167
	fz	0.091	0.106	0.121	0.136	0.156	0.164	0.174	0.179	0.184	0.189	0.192	0.195	0.199	0.205	0.212	0.218	0.224	0.23	0.238	0.25	0.264	0.27
	RPM	19841	17007	14881	13015	11141	9723	8329	7786	7230	6645	6291	5942	5570	4861	4165	3967	3752	3544	3342	3006	2674	2126
11.2	FEED	3611	3605	3601	3540	3476	3189	2899	2788	2661	2512	2416	2317	2217	1993	1766	1729	1681	1630	1591	1503	1412	1148
	Vc	180	180	180	177	168	162	152	153	153	161	162	161	168	161	151	155	158	160	161	164	162	162
	fz	0.083	0.097	0.111	0.122	0.138	0.144	0.153	0.156	0.159	0.164	0.167	0.17	0.174	0.18	0.188	0.197	0.208	0.221	0.206	0.215	0.227	0.231
15	RPM	19099	16370	14324	12520	10695	9376	8064	7493	6957	6406	6067	5694	5348	4659	4005	3795	3592	3395	3203	2900	2578	2063
	FEED	3170	3176	3180	3055	2952	2700	2468	2338	2212	2101	2026	1936	1861	1677	1506	1495	1494	1501	1320	1247	1171	953
	Vc	187	187	187	184	175	168	157	159	159	167	168	168	175	168	157	162	165	167	168	170	168	167
20	fz	0.091	0.106	0.121	0.136	0.156	0.164	0.174	0.179	0.184	0.189	0.192	0.195	0.199	0.205	0.212	0.218	0.224	0.23	0.238	0.25	0.264	0.27
	RPM	19841	17007	14881	13015	11141	9723	8329	7786	7230	6645	6291	5942	5570	4861	4165	3967	3752	3544	3342	3006	2674	2126
	FEED	3611	3605	3601	3540	3476	3189	2899	2788	2661	2512	2416	2317	2217	1993	1766	1729	1681	1630	1591	1503	1412	1148
38.1	Vc	151	151	151	148	141	135	124	127	128	136	136	136	141	136	127	131	133	135	136	137	136	136
	fz	0.075	0.088	0.1	0.111	0.125	0.132	0.141	0.144	0.147	0.15	0.153	0.156	0.16	0.164	0.17	0.173	0.178	0.183	0.189	0.198	0.208	0.211
	RPM	16022	13733	12016	10469	8976	7813	6578	6219	5821	5411	5093	4810	4488	3935	3369	3208	3024	2865	2706	2423	2165	1732
38.2	FEED	2403	2417	2403	2324	2244	2063	1855	1791	1711	1623	1558	1501	1436	1291	1145	1110	1077	1049	1023	959	900	731
	Vc	180	180	180	177	168	162	152	153	153	161	162	161	168	161	151	155	158	160	161	164	162	162
	fz	0.083	0.097	0.111	0.122	0.138	0.144	0.153	0.156	0.159	0.164	0.167	0.17	0.174	0.18	0.188	0.197	0.208	0.221	0.206	0.215	0.227	0.231
40	RPM	19099	16370	14324	12520	10695	9376	8064	7493	6957	6406	6067	5694	5348	4659	4005	3795	3592	3395	3203	2900	2578	2063
	FEED	3170	3176	3180	3055	2952	2700	2468	2338	2212	2101	2026	1936	1861	1677	1506	1495	1494	1501	1320	1247	1171	953
	Vc	151	151	151	148	141	135	124	127	128	136	136	136	141	136	127	131	133	135	136	137	136	136
41	fz	0.075	0.088	0.1	0.111	0.125	0.132	0.141	0.144	0.147	0.15	0.153	0.156	0.16	0.164	0.17	0.173	0.178	0.183	0.189	0.198	0.208	0.211
	RPM	16022	13733	12016	10469	8976	7813	6578	6219	5821	5411	5093	4810	4488	3935	3369	3208	3024	2865	2706	2423	2165	1732
	FEED	2403	2417	2403	2324	2244	2063	1855	1791	1711	1623	1558	1501	1436	1291	1145	1110	1077	1049	1023	959	900	731

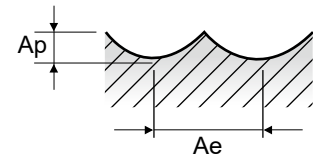

HSS

CBN END MILLS

i-Xmill END MILLS

i-SMART MODULAR END MILLS

X5070 END MILLS

4G MILL END MILLS

X-POWER PRO END MILLS

TitaNox-POWER END MILLS

JET-POWER END MILLS

V7 PLUS END MILLS

ALU-POWER HPC END MILLS

ALU-POWER END MILLS

D-POWER GRAPHITE END MILLS

D-POWER CFRP END MILLS

ROUTERS

CRX S END MILLS

K-2 END MILLS

ONLY ONE COATED PM60 END MILLS

TANK-POWER END MILLS

GENERAL HSS END MILLS

MILLING CUTTERS

TECHNICAL DATA

SEM846 SERIES

2 FLUTE BALL NOSE - SLOTTING

Vc = m/min. fz = mm/tooth
RPM = rev./min. FEED = mm/min.
Ap = mm LBS = Length Below Shank

ISO	VDI 3323	Material Description	Parameter	Diameter (Ø)																					
				0.1		0.1		0.1		0.1		0.2		0.2		0.2		0.3		0.3		0.3		0.3	
				LBS	0.2	0.3	0.5	1	0.5	1	1.5	2	3	1	1.5	2	2.5	3	4						
P	1-5	Non-alloy steel	Vc	16	16	16	14	31	31	28	28	28	28	28	47	47	42	42	42	38					
			fz	0.002	0.002	0.002	0.002	0.003	0.003	0.003	0.003	0.003	0.003	0.005	0.005	0.004	0.004	0.004	0.004						
			RPM	50930	50930	50930	44563	49338	49338	44563	44563	44563	49869	49869	44563	44563	44563	40319							
	6-8	Low alloy steel	FEED	204	204	204	178	296	296	267	267	267	499	499	357	357	357	323							
			Ap	0.009	0.009	0.006	0.002	0.018	0.013	0.007	0.005	0.003	0.019	0.019	0.011	0.007	0.007	0.004							
			Vc	16	16	16	14	31	31	28	28	28	28	47	47	42	42	42	38						
	9	Low alloy steel	fz	0.002	0.002	0.002	0.002	0.003	0.003	0.003	0.003	0.003	0.005	0.005	0.004	0.004	0.004	0.004							
			RPM	50930	50930	50930	44563	49338	49338	44563	44563	44563	49869	49869	44563	44563	44563	40319							
			FEED	204	204	204	178	296	296	267	267	267	499	499	357	357	357	323							
	10-11.1	High alloyed steel, and tool steel	Ap	0.007	0.007	0.005	0.002	0.014	0.01	0.006	0.004	0.003	0.015	0.015	0.008	0.005	0.005	0.003							
			Vc	16	16	16	14	31	31	28	28	28	28	47	47	42	42	42	38						
			fz	0.002	0.002	0.002	0.002	0.003	0.003	0.003	0.003	0.003	0.005	0.005	0.004	0.004	0.004	0.004							
11.2	High alloyed steel, and tool steel	RPM	50930	50930	50930	44563	49338	49338	44563	44563	44563	49869	49869	44563	44563	44563	40319								
		FEED	204	204	204	178	296	296	267	267	267	499	499	357	357	357	323								
		Ap	0.009	0.009	0.006	0.002	0.018	0.013	0.007	0.005	0.003	0.019	0.019	0.011	0.007	0.007	0.004								
K	15-20	Grey cast iron Nodular cast iron Malleable cast iron	Vc	16	16	16	14	31	31	28	28	28	28	47	47	42	42	42	38						
			fz	0.002	0.002	0.002	0.002	0.003	0.003	0.003	0.003	0.003	0.005	0.005	0.004	0.004	0.004	0.004							
			RPM	50930	50930	50930	44563	49338	49338	44563	44563	44563	49869	49869	44563	44563	44563	40319							
H	38.1 - 38.2	Hardened steel	FEED	204	204	204	178	296	296	267	267	267	499	499	357	357	357	323							
			Ap	0.009	0.009	0.006	0.002	0.018	0.013	0.007	0.005	0.003	0.019	0.019	0.011	0.007	0.007	0.004							
			Vc	16	16	16	14	31	31	28	28	28	28	47	47	42	42	42	38						
40	Chilled Cast Iron	fz	0.002	0.002	0.002	0.002	0.003	0.003	0.003	0.003	0.003	0.004	0.004	0.004	0.004	0.004	0.004								
		RPM	50930	50930	50930	44563	49338	49338	44563	44563	44563	49869	49869	44563	44563	44563	40319								
		FEED	204	204	204	178	296	296	267	267	267	499	499	357	357	357	323								
41	Hardened Cast Iron	Ap	0.007	0.007	0.005	0.002	0.014	0.01	0.006	0.004	0.003	0.015	0.015	0.008	0.005	0.005	0.003								
		Vc	16	16	16	14	31	31	28	28	28	28	47	47	42	42	42	38							
		fz	0.002	0.002	0.002	0.002	0.003	0.003	0.003	0.003	0.003	0.004	0.004	0.004	0.004	0.004	0.004								
ROUTERS	CRX S END MILLS	K-2 END MILLS	RPM	50930	50930	50930	44563	42972	42972	38197	38197	38197	42441	38197	38197	38197	38197	33953							
			FEED	204	204	204	178	258	258	229	229	229	340	340	306	306	306	204							
			Ap	0.005	0.005	0.004	0.001	0.01	0.007	0.004	0.003	0.002	0.011	0.011	0.006	0.004	0.004	0.002							
GENERAL HSS END MILLS	MILLING CUTTERS	TECHNICAL DATA	Vc	16	16	16	14	27	27	24	24	24	40	40	36	36	36	32							
			fz	0.002	0.002	0.002	0.002	0.003	0.003	0.003	0.003	0.003	0.004	0.004	0.004	0.004	0.004	0.004							
			RPM	50930	50930	50930	44563	42972	42972	38197	38197	38197	42441	42441	38197	38197	38197	33953							
ROUTERS	CRX S END MILLS	K-2 END MILLS	FEED	204	204	204	178	258	258	229	229	229	340	340	306	306	306	204							
			Ap	0.005	0.005	0.004	0.001	0.01	0.007	0.004	0.003	0.002	0.011	0.011	0.006	0.004	0.004	0.002							
			Vc	16	16	16	14	27	27	24	24	24	40	40	36	36	36	32							

▶ NEXT PAGE

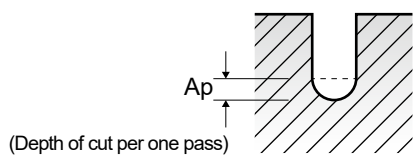

YG 4G MILL END MILLS

RECOMMENDED CUTTING CONDITIONS EMPFOHLENE SCHNEIDPARAMETER

SEM846 SERIES 2 FLUTE BALL NOSE - SLOTTING

Vc = m/min. fz = mm/tooth
RPM = rev./min. FEED = mm/min.
Ap = mm LBS = Length Below Shank

VDI 3323	Parameter	Diameter (Ø)																			
		0.3	0.4	0.4	0.4	0.4	0.4	0.4	0.4	0.4	0.4	0.4	0.5	0.5	0.5	0.5	0.5	0.5	0.5	0.5	
	LBS	5	1	1.5	2	2.5	3	4	5	6	8	10	1	1.5	2	2.5	3	4	5	6	8
1-5	Vc	28	52	52	52	46	46	46	41	41	31	15	54	54	54	54	48	48	48	43	32
	fz	0.003	0.006	0.006	0.006	0.005	0.005	0.005	0.005	0.005	0.004	0.004	0.01	0.01	0.01	0.01	0.009	0.009	0.009	0.008	0.007
	RPM	29709	41380	41380	41380	36606	36606	36606	32627	32627	24669	11937	34377	34377	34377	34377	30558	30558	30558	27375	20372
	FEED	178	497	497	497	366	366	366	326	326	197	95	688	688	688	688	550	550	550	438	285
	Ap	0.003	0.036	0.025	0.025	0.014	0.014	0.009	0.009	0.005	0.004	0.004	0.045	0.045	0.032	0.032	0.018	0.018	0.011	0.011	0.007
6-8	Vc	28	52	52	52	46	46	46	41	41	31	15	54	54	54	54	48	48	48	43	32
	fz	0.003	0.006	0.006	0.006	0.005	0.005	0.005	0.005	0.005	0.004	0.004	0.01	0.01	0.01	0.01	0.009	0.009	0.009	0.008	0.007
	RPM	29709	41380	41380	41380	36606	36606	36606	32627	32627	24669	11937	34377	34377	34377	34377	30558	30558	30558	27375	20372
	FEED	178	497	497	497	366	366	366	326	326	197	95	688	688	688	688	550	550	550	438	285
	Ap	0.003	0.036	0.025	0.025	0.014	0.014	0.009	0.009	0.005	0.004	0.004	0.045	0.045	0.032	0.032	0.018	0.018	0.011	0.011	0.007
9	Vc	28	49	49	49	44	44	44	39	39	29	15	51	51	51	51	46	46	46	41	30
	fz	0.003	0.005	0.005	0.005	0.005	0.005	0.005	0.004	0.004	0.004	0.003	0.009	0.009	0.009	0.009	0.008	0.008	0.008	0.008	0.007
	RPM	29709	38993	38993	38993	35014	35014	35014	31035	31035	23077	11937	32468	32468	32468	32468	29285	29285	29285	26101	19099
	FEED	178	390	390	390	350	350	350	248	248	185	72	584	584	584	584	469	469	469	365	229
	Ap	0.002	0.028	0.02	0.02	0.011	0.011	0.007	0.007	0.004	0.003	0.003	0.035	0.035	0.025	0.025	0.014	0.014	0.009	0.009	0.005
10 - 11.1	Vc	28	52	52	52	46	46	46	41	41	31	15	54	54	54	54	48	48	48	43	32
	fz	0.003	0.006	0.006	0.006	0.005	0.005	0.005	0.005	0.005	0.004	0.004	0.01	0.01	0.01	0.01	0.009	0.009	0.009	0.008	0.007
	RPM	29709	41380	41380	41380	36606	36606	36606	32627	32627	24669	11937	34377	34377	34377	34377	30558	30558	30558	27375	20372
	FEED	178	497	497	497	366	366	366	326	326	197	95	688	688	688	688	550	550	550	438	285
	Ap	0.003	0.036	0.025	0.025	0.014	0.014	0.009	0.009	0.005	0.004	0.004	0.045	0.045	0.032	0.032	0.018	0.018	0.011	0.011	0.007
11.2	Vc	28	49	49	49	44	44	44	39	39	29	15	51	51	51	51	46	46	46	41	30
	fz	0.003	0.005	0.005	0.005	0.005	0.005	0.005	0.004	0.004	0.004	0.003	0.009	0.009	0.009	0.009	0.008	0.008	0.008	0.008	0.007
	RPM	29709	38993	38993	38993	35014	35014	35014	31035	31035	23077	11937	32468	32468	32468	32468	29285	29285	29285	26101	19099
	FEED	178	390	390	390	350	350	350	248	248	185	72	584	584	584	584	469	469	469	365	229
	Ap	0.002	0.028	0.02	0.02	0.011	0.011	0.007	0.007	0.004	0.003	0.003	0.035	0.035	0.025	0.025	0.014	0.014	0.009	0.009	0.005
15 - 20	Vc	28	52	52	52	46	46	46	41	41	31	15	54	54	54	54	48	48	48	43	32
	fz	0.003	0.006	0.006	0.006	0.005	0.005	0.005	0.005	0.005	0.004	0.004	0.01	0.01	0.01	0.01	0.009	0.009	0.009	0.008	0.007
	RPM	29709	41380	41380	41380	36606	36606	36606	32627	32627	24669	11937	34377	34377	34377	34377	30558	30558	30558	27375	20372
	FEED	178	497	497	497	366	366	366	326	326	197	95	688	688	688	688	550	550	550	438	285
	Ap	0.003	0.036	0.025	0.025	0.014	0.014	0.009	0.009	0.005	0.004	0.004	0.045	0.045	0.032	0.032	0.018	0.018	0.011	0.011	0.007
38.1 - 38.2	Vc	24	43	43	43	39	39	39	34	34	26	13	45	45	45	45	40	40	40	36	27
	fz	0.003	0.005	0.005	0.005	0.004	0.004	0.004	0.004	0.004	0.004	0.003	0.009	0.009	0.009	0.009	0.008	0.008	0.008	0.007	0.006
	RPM	25465	34218	34218	34218	31035	31035	31035	27056	27056	20690	10345	28648	28648	28648	28648	25465	25465	25465	22918	17189
	FEED	153	342	342	342	248	248	248	216	216	166	62	516	516	516	516	407	407	407	321	206
	Ap	0.002	0.02	0.014	0.014	0.008	0.008	0.005	0.005	0.003	0.002	0.002	0.025	0.025	0.018	0.018	0.01	0.01	0.006	0.006	0.004
40	Vc	28	49	49	49	44	44	44	39	39	29	15	51	51	51	51	46	46	46	41	30
	fz	0.003	0.005	0.005	0.005	0.005	0.005	0.005	0.004	0.004	0.004	0.003	0.009	0.009	0.009	0.009	0.008	0.008	0.008	0.007	0.006
	RPM	29709	38993	38993	38993	35014	35014	35014	31035	31035	23077	11937	32468	32468	32468	32468	29285	29285	29285	26101	19099
	FEED	178	390	390	390	350	350	350	248	248	185	72	584	584	584	584	469	469	469	365	229
	Ap	0.002	0.028	0.02	0.02	0.011	0.011	0.007	0.007	0.004	0.003	0.003	0.035	0.035	0.025	0.025	0.014	0.014	0.009	0.009	0.005
41	Vc	24	43	43	43	39	39	39	34	34	26	13	45	45	45	45	40	40	40	36	27
	fz	0.003	0.005	0.005	0.005	0.004	0.004	0.004	0.004	0.004	0.004	0.003	0.009	0.009	0.009	0.009	0.008	0.008	0.008	0.007	0.006
	RPM	25465	34218	34218	34218	31035	31035	31035	27056	27056	20690	10345	28648	28648	28648	28648	25465	25465	25465	22918	17189
	FEED	153	342	342	342	248	248	248	216	216	166	62	516	516	516	516	407	407	407	321	206
	Ap	0.002	0.02	0.014	0.014	0.008	0.008	0.005	0.005	0.003	0.002	0.002	0.025	0.025	0.018	0.018	0.01	0.01	0.006	0.006	0.004

▶ NEXT PAGE

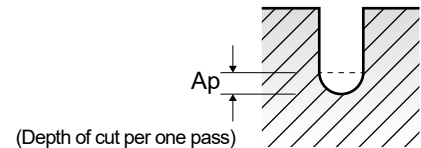



4G MILL END MILLS

RECOMMENDED CUTTING CONDITIONS EMPFOHLENE SCHNEIDPARAMETER

SEM846 SERIES

2 FLUTE BALL NOSE - **SLOTTING**

Vc = m/min. fz = mm/tooth
RPM = rev./min. FEED = mm/min.
Ap = mm LBS = Length Below Shank

ISO	VDI 3323	Parameter	Diameter (Ø)																
			0.5	0.5	0.5	0.5	0.6	0.6	0.6	0.6	0.6	0.6	0.6	0.6	0.6	0.6	0.7	0.7	
			LBS	10	12	14	16	1	2	3	4	5	6	8	10	12	14	16	2
P	1-5	Vc	32	16	16	5	64	64	64	58	58	58	52	39	39	19	19	75	68
		fz	0.007	0.006	0.006	0.005	0.015	0.015	0.015	0.013	0.013	0.013	0.012	0.01	0.01	0.009	0.009	0.017	0.015
		RPM	20372	10186	10186	3183	33953	33953	33953	30770	30770	30770	27587	20690	20690	10080	10080	34105	30922
		FEED	285	122	122	32	1019	1019	1019	800	800	800	662	414	414	181	181	1160	928
	6-8	Ap	0.005	0.005	0.005	0.005	0.038	0.038	0.038	0.022	0.014	0.014	0.008	0.005	0.005	0.005	0.005	0.063	0.025
		Vc	32	16	16	5	64	64	64	58	58	58	52	39	39	19	19	75	68
		fz	0.007	0.006	0.006	0.005	0.015	0.015	0.015	0.013	0.013	0.013	0.012	0.01	0.01	0.009	0.009	0.017	0.015
		RPM	20372	10186	10186	3183	33953	33953	33953	30770	30770	30770	27587	20690	20690	10080	10080	34105	30922
	9	FEED	285	122	122	32	1019	1019	1019	800	800	800	662	414	414	181	181	1160	928
		Ap	0.005	0.005	0.005	0.005	0.038	0.038	0.038	0.022	0.014	0.014	0.008	0.005	0.005	0.005	0.005	0.063	0.025
		Vc	30	15	15	5	61	61	61	55	55	55	49	37	37	18	18	71	64
		fz	0.006	0.005	0.005	0.005	0.013	0.013	0.013	0.012	0.012	0.012	0.01	0.009	0.009	0.008	0.008	0.014	0.013
10-11.1	RPM	19099	9549	9549	3183	32362	32362	32362	29178	29178	29178	25995	19629	19629	9549	9549	32286	29103	
	FEED	229	95	95	32	841	841	841	700	700	700	520	353	353	153	153	904	757	
	Ap	0.004	0.004	0.004	0.004	0.029	0.029	0.029	0.017	0.011	0.011	0.006	0.004	0.004	0.004	0.004	0.049	0.02	
	Vc	32	16	16	5	64	64	64	58	58	58	52	39	39	19	19	75	68	
11.2	fz	0.007	0.006	0.006	0.005	0.015	0.015	0.015	0.013	0.013	0.013	0.012	0.01	0.01	0.009	0.009	0.017	0.015	
	RPM	20372	10186	10186	3183	33953	33953	33953	30770	30770	30770	27587	20690	20690	10080	10080	34105	30922	
	FEED	285	122	122	32	1019	1019	1019	800	800	800	662	414	414	181	181	1160	928	
	Ap	0.005	0.005	0.005	0.005	0.038	0.038	0.038	0.022	0.014	0.014	0.008	0.005	0.005	0.005	0.005	0.063	0.025	
K	15-20	Vc	30	15	15	5	61	61	61	55	55	55	49	37	37	18	18	71	64
		fz	0.006	0.005	0.005	0.005	0.013	0.013	0.013	0.012	0.012	0.012	0.01	0.009	0.009	0.008	0.008	0.014	0.013
		RPM	19099	9549	9549	3183	32362	32362	32362	29178	29178	29178	25995	19629	19629	9549	9549	32286	29103
		FEED	229	95	95	32	841	841	841	700	700	700	520	353	353	153	153	904	757
H	38.1 - 38.2	Ap	0.004	0.004	0.004	0.004	0.029	0.029	0.029	0.017	0.011	0.011	0.006	0.004	0.004	0.004	0.004	0.049	0.02
		Vc	32	16	16	5	64	64	64	58	58	58	52	39	39	19	19	75	68
		fz	0.007	0.006	0.006	0.005	0.015	0.015	0.015	0.013	0.013	0.013	0.012	0.01	0.01	0.009	0.009	0.017	0.015
		RPM	20372	10186	10186	3183	33953	33953	33953	30770	30770	30770	27587	20690	20690	10080	10080	34105	30922
	40	FEED	285	122	122	32	1019	1019	1019	800	800	800	662	414	414	181	181	1160	928
		Ap	0.005	0.005	0.005	0.005	0.038	0.038	0.038	0.022	0.014	0.014	0.008	0.005	0.005	0.005	0.005	0.063	0.025
		Vc	27	13	13	4	54	54	54	48	48	48	43	32	32	16	16	63	56
		fz	0.006	0.006	0.006	0.004	0.012	0.012	0.012	0.011	0.011	0.011	0.01	0.008	0.008	0.007	0.007	0.013	0.012
	41	RPM	17189	8276	8276	2546	28648	28648	28648	25465	25465	25465	22812	16977	16977	8488	8488	28648	25465
		FEED	206	99	99	20	688	688	688	560	560	560	456	272	272	119	119	745	611
		Ap	0.003	0.003	0.003	0.003	0.021	0.021	0.021	0.012	0.008	0.008	0.005	0.003	0.003	0.003	0.003	0.035	0.014
		Vc	30	15	15	5	61	61	61	55	55	55	49	37	37	18	18	71	64
ROUTERS	CRX S END MILLS	fz	0.006	0.005	0.005	0.005	0.013	0.013	0.013	0.012	0.012	0.012	0.01	0.009	0.009	0.008	0.008	0.014	0.013
		RPM	19099	9549	9549	3183	32362	32362	32362	29178	29178	29178	25995	19629	19629	9549	9549	32286	29103
		FEED	229	95	95	32	841	841	841	700	700	700	520	353	353	153	153	904	757
		Ap	0.004	0.004	0.004	0.004	0.029	0.029	0.029	0.017	0.011	0.011	0.006	0.004	0.004	0.004	0.004	0.049	0.02
K-2 END MILLS	ONLY ONE COATED PM60 END MILLS	Vc	27	13	13	4	54	54	54	48	48	48	43	32	32	16	16	63	56
		fz	0.006	0.006	0.006	0.004	0.012	0.012	0.012	0.011	0.011	0.011	0.01	0.008	0.008	0.007	0.007	0.013	0.012
		RPM	17189	8276	8276	2546	28648	28648	28648	25465	25465	25465	22812	16977	16977	8488	8488	28648	25465
		FEED	206	99	99	20	688	688	688	560	560	560	456	272	272	119	119	745	611
TANK-POWER END MILLS	GENERAL HSS END MILLS	Ap	0.003	0.003	0.003	0.003	0.021	0.021	0.021	0.012	0.008	0.008	0.005	0.003	0.003	0.003	0.003	0.035	0.014
		Vc	27	13	13	4	54	54	54	48	48	48	43	32	32	16	16	63	56
		fz	0.006	0.006	0.006	0.004	0.012	0.012	0.012	0.011	0.011	0.011	0.01	0.008	0.008	0.007	0.007	0.013	0.012
		RPM	17189	8276	8276	2546	28648	28648	28648	25465	25465	25465	22812	16977	16977	8488	8488	28648	25465
MILLING CUTTERS	TECHNICAL DATA	FEED	206	99	99	20	688	688	688	560	560	560	456	272	272	119	119	745	611
		Ap	0.003	0.003	0.003	0.003	0.021	0.021	0.021	0.012	0.008	0.008	0.005	0.003	0.003	0.003	0.003	0.035	0.014

▶ NEXT PAGE

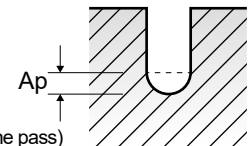

SEM846 SERIES

2 FLUTE BALL NOSE - SLOTTING

Vc = m/min. fz = mm/tooth
 RPM = rev./min. FEED = mm/min.
 Ap = mm LBS = Length Below Shank

ISO	VDI 3323	Parameter	Diameter (Ø)																
			1.0	1.0	1.0	1.0	1.0	1.0	1.0	1.0	1.0	1.0	1.0	1.0	1.0	1.0	1.0	1.0	
			LBS	3	4	5	6	7	8	10	12	14	16	18	20	22	26	30	40
P	1-5	Vc	97	97	97	87	87	87	87	77	77	58	58	58	29	29	29	10	10
		fz	0.025	0.025	0.025	0.022	0.022	0.022	0.022	0.02	0.02	0.017	0.017	0.017	0.015	0.015	0.015	0.012	0.012
		RPM	30876	30876	30876	27693	27693	27693	27693	24510	24510	18462	18462	18462	9231	9231	9231	3183	3183
	6-8	FEED	1544	1544	1544	1218	1218	1218	1218	980	980	628	628	628	277	277	277	76	76
		Ap	0.09	0.063	0.063	0.036	0.036	0.036	0.023	0.023	0.014	0.014	0.009	0.009	0.009	0.009	0.009	0.009	0.006
		Vc	97	97	97	87	87	87	87	77	77	58	58	58	29	29	29	10	10
	9	fz	0.025	0.025	0.025	0.022	0.022	0.022	0.022	0.02	0.02	0.017	0.017	0.017	0.015	0.015	0.015	0.012	0.012
		RPM	30876	30876	30876	27693	27693	27693	27693	24510	24510	18462	18462	18462	9231	9231	9231	3183	3183
		FEED	1544	1544	1544	1218	1218	1218	1218	980	980	628	628	628	277	277	277	76	76
	10-11.1	Ap	0.09	0.063	0.063	0.036	0.036	0.036	0.023	0.023	0.014	0.014	0.009	0.009	0.009	0.009	0.009	0.009	0.006
		Vc	91	91	91	82	82	82	82	73	73	55	55	55	27	27	27	9	9
		fz	0.023	0.023	0.023	0.02	0.02	0.02	0.02	0.018	0.018	0.016	0.016	0.016	0.013	0.013	0.013	0.011	0.011
11.2	RPM	28966	28966	28966	26101	26101	26101	26101	23237	23237	17507	17507	17507	8594	8594	8594	2865	2865	
	FEED	1332	1332	1332	1044	1044	1044	1044	837	837	560	560	560	223	223	223	63	63	
	Ap	0.07	0.049	0.049	0.028	0.028	0.028	0.018	0.018	0.011	0.011	0.007	0.007	0.007	0.007	0.007	0.007	0.005	
K	15-20	Vc	97	97	97	87	87	87	87	77	77	58	58	58	29	29	29	10	10
		fz	0.025	0.025	0.025	0.022	0.022	0.022	0.022	0.02	0.02	0.017	0.017	0.017	0.015	0.015	0.015	0.012	0.012
		RPM	30876	30876	30876	27693	27693	27693	27693	24510	24510	18462	18462	18462	9231	9231	9231	3183	3183
H	38.1 - 38.2	FEED	1544	1544	1544	1218	1218	1218	1218	980	980	628	628	628	277	277	277	76	76
		Ap	0.09	0.063	0.063	0.036	0.036	0.036	0.023	0.023	0.014	0.014	0.009	0.009	0.009	0.009	0.009	0.009	0.006
		Vc	81	81	81	73	73	73	73	65	65	48	48	48	24	24	24	8	8
40	fz	0.021	0.021	0.021	0.019	0.019	0.019	0.019	0.017	0.017	0.015	0.015	0.015	0.013	0.013	0.013	0.011	0.011	
	RPM	25783	25783	25783	23237	23237	23237	23237	20690	20690	15279	15279	15279	7639	7639	7639	2546	2546	
	FEED	1083	1083	1083	883	883	883	883	703	703	458	458	458	199	199	199	56	56	
41	Ap	0.05	0.035	0.035	0.02	0.02	0.02	0.013	0.013	0.008	0.008	0.005	0.005	0.005	0.005	0.005	0.005	0.003	
	Vc	91	91	91	82	82	82	82	73	73	55	55	55	27	27	27	9	9	
	fz	0.023	0.023	0.023	0.02	0.02	0.02	0.02	0.018	0.018	0.016	0.016	0.016	0.013	0.013	0.013	0.011	0.011	
ROUTERS	CRX S END MILLS	RPM	28966	28966	28966	26101	26101	26101	26101	23237	23237	17507	17507	17507	8594	8594	8594	2865	2865
		FEED	1332	1332	1332	1044	1044	1044	1044	837	837	560	560	560	223	223	223	63	63
		Ap	0.07	0.049	0.049	0.028	0.028	0.028	0.018	0.018	0.011	0.011	0.007	0.007	0.007	0.007	0.007	0.007	0.005
K-2 END MILLS	ONLY ONE COATED PM60 END MILLS	Vc	81	81	81	73	73	73	73	65	65	48	48	48	24	24	24	8	8
		fz	0.021	0.021	0.021	0.019	0.019	0.019	0.019	0.017	0.017	0.015	0.015	0.015	0.013	0.013	0.013	0.011	0.011
		RPM	25783	25783	25783	23237	23237	23237	23237	20690	20690	15279	15279	15279	7639	7639	7639	2546	2546
TANK-POWER END MILLS	GENERAL HSS END MILLS	FEED	1083	1083	1083	883	883	883	883	703	703	458	458	458	199	199	199	56	56
		Ap	0.05	0.035	0.035	0.02	0.02	0.02	0.013	0.013	0.008	0.008	0.005	0.005	0.005	0.005	0.005	0.005	0.003
		Vc	81	81	81	73	73	73	73	65	65	48	48	48	24	24	24	8	8
MILLING CUTTERS	TECHNICAL DATA	fz	0.021	0.021	0.021	0.019	0.019	0.019	0.019	0.017	0.017	0.015	0.015	0.015	0.013	0.013	0.013	0.011	0.011
		RPM	25783	25783	25783	23237	23237	23237	23237	20690	20690	15279	15279	15279	7639	7639	7639	2546	2546
		FEED	1083	1083	1083	883	883	883	883	703	703	458	458	458	199	199	199	56	56

▶ NEXT PAGE

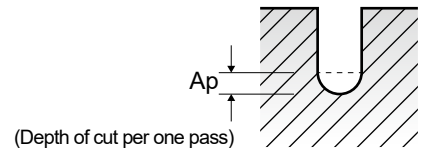



RECOMMENDED CUTTING CONDITIONS EMPFOHLENE SCHNEIDPARAMETER

SEM846 SERIES 2 FLUTE BALL NOSE - SLOTTING

Vc = m/min. fz = mm/tooth
RPM = rev./min. FEED = mm/min.
Ap = mm LBS = Length Below Shank

ISO	VDI 3323	Parameter	Diameter (Ø)																	
			1.5	1.5	1.5	1.5	1.5	1.5	1.5	1.5	1.5	1.6	1.6	1.6	1.6	1.6	1.6	1.6	1.8	1.8
			LBS	16	18	20	22	26	30	35	40	4	6	8	10	12	16	20	4	6
P	1-5	Vc	90	90	90	90	68	68	34	34	112	112	112	100	100	100	89	126	126	
		fz	0.026	0.026	0.026	0.026	0.023	0.023	0.02	0.02	0.035	0.035	0.035	0.032	0.032	0.032	0.028	0.04	0.04	
		RPM	19099	19099	19099	19099	14430	14430	7215	7215	22282	22282	22282	19894	19894	19894	17706	22282	22282	
		FEED	993	993	993	993	664	664	289	289	1560	1560	1560	1273	1273	1273	992	1783	1783	
		Ap	0.034	0.034	0.02	0.02	0.014	0.014	0.01	0.01	0.101	0.101	0.101	0.058	0.058	0.058	0.036	0.113	0.113	
	6-8	Vc	90	90	90	90	68	68	34	34	112	112	112	100	100	100	89	126	126	
		fz	0.026	0.026	0.026	0.026	0.023	0.023	0.02	0.02	0.035	0.035	0.035	0.032	0.032	0.032	0.028	0.04	0.04	
		RPM	19099	19099	19099	19099	14430	14430	7215	7215	22282	22282	22282	19894	19894	19894	17706	22282	22282	
		FEED	993	993	993	993	664	664	289	289	1560	1560	1560	1273	1273	1273	992	1783	1783	
		Ap	0.034	0.034	0.02	0.02	0.014	0.014	0.01	0.01	0.101	0.101	0.101	0.058	0.058	0.058	0.036	0.113	0.113	
	9	Vc	85	85	85	85	64	64	32	32	106	106	106	95	95	95	84	119	119	
		fz	0.024	0.024	0.024	0.024	0.021	0.021	0.018	0.018	0.031	0.031	0.031	0.028	0.028	0.028	0.025	0.035	0.035	
		RPM	18038	18038	18038	18038	13581	13581	6791	6791	21088	21088	21088	18900	18900	18900	16711	21044	21044	
		FEED	866	866	866	866	570	570	244	244	1307	1307	1307	1058	1058	1058	836	1473	1473	
		Ap	0.026	0.026	0.016	0.016	0.011	0.011	0.008	0.008	0.078	0.078	0.078	0.045	0.045	0.045	0.028	0.088	0.088	
	10-11.1	Vc	90	90	90	90	68	68	34	34	112	112	112	100	100	100	89	126	126	
		fz	0.026	0.026	0.026	0.026	0.023	0.023	0.02	0.02	0.035	0.035	0.035	0.032	0.032	0.032	0.028	0.04	0.04	
		RPM	19099	19099	19099	19099	14430	14430	7215	7215	22282	22282	22282	19894	19894	19894	17706	22282	22282	
		FEED	993	993	993	993	664	664	289	289	1560	1560	1560	1273	1273	1273	992	1783	1783	
		Ap	0.034	0.034	0.02	0.02	0.014	0.014	0.01	0.01	0.101	0.101	0.101	0.058	0.058	0.058	0.036	0.113	0.113	
11.2	Vc	85	85	85	85	64	64	32	32	106	106	106	95	95	95	84	119	119		
	fz	0.024	0.024	0.024	0.024	0.021	0.021	0.018	0.018	0.031	0.031	0.031	0.028	0.028	0.028	0.025	0.035	0.035		
	RPM	18038	18038	18038	18038	13581	13581	6791	6791	21088	21088	21088	18900	18900	18900	16711	21044	21044		
	FEED	866	866	866	866	570	570	244	244	1307	1307	1307	1058	1058	1058	836	1473	1473		
	Ap	0.026	0.026	0.016	0.016	0.011	0.011	0.008	0.008	0.078	0.078	0.078	0.045	0.045	0.045	0.028	0.088	0.088		
K	15-20	Vc	90	90	90	90	68	68	34	34	112	112	112	100	100	100	89	126	126	
		fz	0.026	0.026	0.026	0.026	0.023	0.023	0.02	0.02	0.035	0.035	0.035	0.032	0.032	0.032	0.028	0.04	0.04	
		RPM	19099	19099	19099	19099	14430	14430	7215	7215	22282	22282	22282	19894	19894	19894	17706	22282	22282	
		FEED	993	993	993	993	664	664	289	289	1560	1560	1560	1273	1273	1273	992	1783	1783	
		Ap	0.034	0.034	0.02	0.02	0.014	0.014	0.01	0.01	0.101	0.101	0.101	0.058	0.058	0.058	0.036	0.113	0.113	
H	38.1 - 38.2	Vc	75	75	75	75	57	57	28	28	93	93	93	84	84	84	74	105	105	
		fz	0.022	0.022	0.022	0.022	0.019	0.019	0.016	0.016	0.03	0.03	0.03	0.027	0.027	0.027	0.024	0.033	0.033	
		RPM	15915	15915	15915	15915	12096	12096	5942	5942	18502	18502	18502	16711	16711	16711	14722	18568	18568	
		FEED	700	700	700	700	460	460	190	190	1110	1110	1110	902	902	902	707	1225	1225	
		Ap	0.019	0.019	0.011	0.011	0.008	0.008	0.005	0.005	0.056	0.056	0.056	0.032	0.032	0.032	0.02	0.063	0.063	
	40	Vc	85	85	85	85	64	64	32	32	106	106	106	95	95	95	84	119	119	
		fz	0.024	0.024	0.024	0.024	0.021	0.021	0.018	0.018	0.031	0.031	0.031	0.028	0.028	0.028	0.025	0.035	0.035	
		RPM	18038	18038	18038	18038	13581	13581	6791	6791	21088	21088	21088	18900	18900	18900	16711	21044	21044	
		FEED	866	866	866	866	570	570	244	244	1307	1307	1307	1058	1058	1058	836	1473	1473	
		Ap	0.026	0.026	0.016	0.016	0.011	0.011	0.008	0.008	0.078	0.078	0.078	0.045	0.045	0.045	0.028	0.088	0.088	
	41	Vc	75	75	75	75	57	57	28	28	93	93	93	84	84	84	74	105	105	
		fz	0.022	0.022	0.022	0.022	0.019	0.019	0.016	0.016	0.03	0.03	0.03	0.027	0.027	0.027	0.024	0.033	0.033	
		RPM	15915	15915	15915	15915	12096	12096	5942	5942	18502	18502	18502	16711	16711	16711	14722	18568	18568	
		FEED	700	700	700	700	460	460	190	190	1110	1110	1110	902	902	902	707	1225	1225	
		Ap	0.019	0.019	0.011	0.011	0.008	0.008	0.005	0.005	0.056	0.056	0.056	0.032	0.032	0.032	0.02	0.063	0.063	

▶ NEXT PAGE

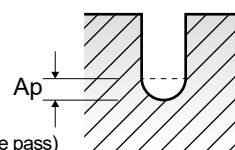

YG 4G MILL END MILLS

RECOMMENDED CUTTING CONDITIONS EMPFOLHENE SCHNEIDPARAMETER

SEM846 SERIES

2 FLUTE BALL NOSE - SLOTTING

Vc = m/min. fz = mm/tooth
RPM = rev./min. FEED = mm/min.
Ap = mm LBS = Length Below Shank

ISO	VDI 3323	Parameter	Diameter (Ø)																	
			2.0	2.5	2.5	2.5	2.5	2.5	2.5	2.5	2.5	2.5	2.5	2.5	2.5	2.5	3.0	3.0	3.0	3.0
			LBS	60	8	10	12	16	20	22	26	30	35	40	45	50	6	8	10	12
P	1-5	Vc	34	124	124	124	112	112	112	99	99	99	74	74	74	129	129	129	129	
		fz	0.03	0.061	0.061	0.061	0.055	0.055	0.055	0.049	0.049	0.049	0.043	0.043	0.043	0.075	0.075	0.075	0.075	
		RPM	5411	15788	15788	15788	14260	14260	14260	12605	12605	12605	9422	9422	9422	13687	13687	13687	13687	
		FEED	325	1926	1926	1926	1569	1569	1569	1235	1235	1235	810	810	810	2053	2053	2053	2053	
	Ap	0.018	0.158	0.158	0.158	0.09	0.09	0.056	0.056	0.056	0.034	0.034	0.023	0.023	0.023	0.27	0.27	0.189	0.189	
	6-8	Vc	34	124	124	124	112	112	112	99	99	99	74	74	74	129	129	129	129	
		fz	0.03	0.061	0.061	0.061	0.055	0.055	0.055	0.049	0.049	0.049	0.043	0.043	0.043	0.075	0.075	0.075	0.075	
		RPM	5411	15788	15788	15788	14260	14260	14260	12605	12605	12605	9422	9422	9422	13687	13687	13687	13687	
		FEED	325	1926	1926	1926	1569	1569	1569	1235	1235	1235	810	810	810	2053	2053	2053	2053	
	Ap	0.018	0.158	0.158	0.158	0.09	0.09	0.056	0.056	0.056	0.034	0.034	0.023	0.023	0.023	0.27	0.27	0.189	0.189	
	9	Vc	32	117	117	117	105	105	105	94	94	94	70	70	70	122	122	122	122	
		fz	0.027	0.054	0.054	0.054	0.048	0.048	0.048	0.043	0.043	0.043	0.038	0.038	0.038	0.067	0.067	0.067	0.067	
		RPM	5093	14897	14897	14897	13369	13369	13369	11968	11968	11968	8913	8913	8913	12945	12945	12945	12945	
		FEED	275	1609	1609	1609	1283	1283	1283	1029	1029	1029	677	677	677	1735	1735	1735	1735	
	Ap	0.014	0.123	0.123	0.123	0.07	0.07	0.044	0.044	0.044	0.026	0.026	0.018	0.018	0.018	0.21	0.21	0.147	0.147	
	10-11.1	Vc	34	124	124	124	112	112	112	99	99	99	74	74	74	129	129	129	129	
		fz	0.03	0.061	0.061	0.061	0.055	0.055	0.055	0.049	0.049	0.049	0.043	0.043	0.043	0.075	0.075	0.075	0.075	
		RPM	5411	15788	15788	15788	14260	14260	14260	12605	12605	12605	9422	9422	9422	13687	13687	13687	13687	
		FEED	325	1926	1926	1926	1569	1569	1569	1235	1235	1235	810	810	810	2053	2053	2053	2053	
	Ap	0.018	0.158	0.158	0.158	0.09	0.09	0.056	0.056	0.056	0.034	0.034	0.023	0.023	0.023	0.27	0.27	0.189	0.189	
11.2	Vc	32	117	117	117	105	105	105	94	94	94	70	70	70	122	122	122	122		
	fz	0.027	0.054	0.054	0.054	0.048	0.048	0.048	0.043	0.043	0.043	0.038	0.038	0.038	0.067	0.067	0.067	0.067		
	RPM	5093	14897	14897	14897	13369	13369	13369	11968	11968	11968	8913	8913	8913	12945	12945	12945	12945		
	FEED	275	1609	1609	1609	1283	1283	1283	1029	1029	1029	677	677	677	1735	1735	1735	1735		
Ap	0.014	0.123	0.123	0.123	0.07	0.07	0.044	0.044	0.044	0.026	0.026	0.018	0.018	0.018	0.21	0.21	0.147	0.147		
K	15-20	Vc	34	124	124	124	112	112	112	99	99	99	74	74	74	129	129	129	129	
		fz	0.03	0.061	0.061	0.061	0.055	0.055	0.055	0.049	0.049	0.049	0.043	0.043	0.043	0.075	0.075	0.075	0.075	
		RPM	5411	15788	15788	15788	14260	14260	14260	12605	12605	12605	9422	9422	9422	13687	13687	13687	13687	
		FEED	325	1926	1926	1926	1569	1569	1569	1235	1235	1235	810	810	810	2053	2053	2053	2053	
Ap	0.018	0.158	0.158	0.158	0.09	0.09	0.056	0.056	0.056	0.034	0.034	0.023	0.023	0.023	0.27	0.27	0.189	0.189		
H	38.1 - 38.2	Vc	28	104	104	104	93	93	93	83	83	83	62	62	62	107	107	107	107	
		fz	0.026	0.049	0.049	0.049	0.044	0.044	0.044	0.04	0.04	0.04	0.035	0.035	0.035	0.063	0.063	0.063	0.063	
		RPM	4456	13242	13242	13242	11841	11841	11841	10568	10568	10568	7894	7894	7894	11353	11353	11353	11353	
		FEED	232	1298	1298	1298	1042	1042	1042	845	845	845	553	553	553	1430	1430	1430	1430	
	Ap	0.01	0.088	0.088	0.088	0.05	0.05	0.031	0.031	0.031	0.019	0.019	0.013	0.013	0.013	0.15	0.15	0.105	0.105	
	40	Vc	32	117	117	117	105	105	105	94	94	94	70	70	70	122	122	122	122	
		fz	0.027	0.054	0.054	0.054	0.048	0.048	0.048	0.043	0.043	0.043	0.038	0.038	0.038	0.067	0.067	0.067	0.067	
		RPM	5093	14897	14897	14897	13369	13369	13369	11968	11968	11968	8913	8913	8913	12945	12945	12945	12945	
		FEED	275	1609	1609	1609	1283	1283	1283	1029	1029	1029	677	677	677	1735	1735	1735	1735	
	Ap	0.014	0.123	0.123	0.123	0.07	0.07	0.044	0.044	0.044	0.026	0.026	0.018	0.018	0.018	0.21	0.21	0.147	0.147	
	41	Vc	28	104	104	104	93	93	93	83	83	83	62	62	62	107	107	107	107	
		fz	0.026	0.049	0.049	0.049	0.044	0.044	0.044	0.04	0.04	0.04	0.035	0.035	0.035	0.063	0.063	0.063	0.063	
RPM		4456	13242	13242	13242	11841	11841	11841	10568	10568	10568	7894	7894	7894	11353	11353	11353	11353		
FEED		232	1298	1298	1298	1042	1042	1042	845	845	845	553	553	553	1430	1430	1430	1430		
Ap	0.01	0.088	0.088	0.088	0.05	0.05	0.031	0.031	0.031	0.019	0.019	0.013	0.013	0.013	0.15	0.15	0.105	0.105		

▶ NEXT PAGE

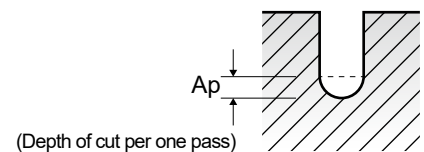

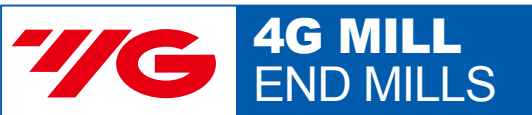

RECOMMENDED CUTTING CONDITIONS
EMPFOHLENE SCHNEIDPARAMETER

HSS

CBN
END MILLS

i-Xmill
END MILLS

i-SMART
MODULAR
END MILLS

X5070
END MILLS

4G MILL
END MILLS

X-POWER
PRO
END MILLS

TitaNox-
POWER
END MILLS

JET-POWER
END MILLS

V7 PLUS
END MILLS

ALU-POWER
HPC
END MILLS

ALU-
POWER
END MILLS

D-POWER
GRAPHITE
END MILLS

D-POWER
CFRP
END MILLS

ROUTERS

CRX S
END MILLS

K-2
END MILLS

ONLY ONE
COATED PM60
END MILLS

TANK-
POWER
END MILLS

GENERAL
HSS
END MILLS

MILLING
CUTTERS

TECHNICAL
DATA

SEM846 SERIES

2 FLUTE BALL NOSE - SLOTTING

Vc = m/min. fz = mm/tooth
RPM = rev./min. FEED = mm/min.
Ap = mm LBS = Length Below Shank

Table with columns for VDI 3323, Parameter (LBS), Diameter (Ø), and various cutting parameters (Vc, fz, RPM, FEED, Ap) for different diameters and series.

▶ NEXT PAGE

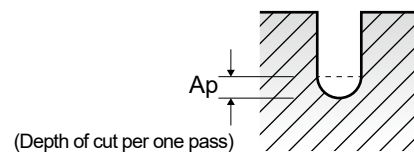

SEM846 SERIES

2 FLUTE BALL NOSE - SLOTTING

Vc = m/min. fz = mm/tooth
RPM = rev./min. FEED = mm/min.
Ap = mm LBS = Length Below Shank

ISO	VDI 3323	Parameter	Diameter (Ø)											
			4.0	4.0	4.0	4.0	4.0	4.0	4.0	5.0	5.0	5.0	5.0	
			LBS	26	30	35	40	45	50	60	15	20	26	30
P	1-5	Vc	111	111	111	111	99	99	99	121	121	109	109	
		fz	0.09	0.09	0.09	0.09	0.08	0.08	0.08	0.12	0.12	0.108	0.108	
		RPM	8833	8833	8833	8833	7878	7878	7878	7703	7703	6939	6939	
		FEED	1590	1590	1590	1590	1261	1261	1261	1849	1849	1499	1499	
		Ap	0.144	0.144	0.09	0.09	0.09	0.09	0.054	0.315	0.315	0.18	0.18	
	6-8	Vc	111	111	111	111	99	99	99	121	121	109	109	
		fz	0.09	0.09	0.09	0.09	0.08	0.08	0.08	0.12	0.12	0.108	0.108	
		RPM	8833	8833	8833	8833	7878	7878	7878	7703	7703	6939	6939	
		FEED	1590	1590	1590	1590	1261	1261	1261	1849	1849	1499	1499	
		Ap	0.144	0.144	0.09	0.09	0.09	0.09	0.054	0.315	0.315	0.18	0.18	
	9	Vc	105	105	105	105	93	93	93	115	115	103	103	
		fz	0.081	0.081	0.081	0.081	0.072	0.072	0.072	0.1	0.1	0.09	0.09	
		RPM	8356	8356	8356	8356	7401	7401	7401	7321	7321	6557	6557	
		FEED	1354	1354	1354	1354	1066	1066	1066	1464	1464	1180	1180	
		Ap	0.112	0.112	0.07	0.07	0.07	0.07	0.042	0.245	0.245	0.14	0.14	
	10-11.1	Vc	111	111	111	111	99	99	99	121	121	109	109	
		fz	0.09	0.09	0.09	0.09	0.08	0.08	0.08	0.12	0.12	0.108	0.108	
		RPM	8833	8833	8833	8833	7878	7878	7878	7703	7703	6939	6939	
		FEED	1590	1590	1590	1590	1261	1261	1261	1849	1849	1499	1499	
		Ap	0.144	0.144	0.09	0.09	0.09	0.09	0.054	0.315	0.315	0.18	0.18	
11.2	Vc	105	105	105	105	93	93	93	115	115	103	103		
	fz	0.081	0.081	0.081	0.081	0.072	0.072	0.072	0.1	0.1	0.09	0.09		
	RPM	8356	8356	8356	8356	7401	7401	7401	7321	7321	6557	6557		
	FEED	1354	1354	1354	1354	1066	1066	1066	1464	1464	1180	1180		
	Ap	0.112	0.112	0.07	0.07	0.07	0.07	0.042	0.245	0.245	0.14	0.14		
K 15-20	Vc	111	111	111	111	99	99	99	121	121	109	109		
	fz	0.09	0.09	0.09	0.09	0.08	0.08	0.08	0.12	0.12	0.108	0.108		
	RPM	8833	8833	8833	8833	7878	7878	7878	7703	7703	6939	6939		
	FEED	1590	1590	1590	1590	1261	1261	1261	1849	1849	1499	1499		
	Ap	0.144	0.144	0.09	0.09	0.09	0.09	0.054	0.315	0.315	0.18	0.18		
H	38.1 - 38.2	Vc	93	93	93	93	82	82	82	101	101	90	90	
		fz	0.077	0.077	0.077	0.077	0.068	0.068	0.068	0.1	0.1	0.09	0.09	
		RPM	7401	7401	7401	7401	6525	6525	6525	6430	6430	5730	5730	
		FEED	1140	1140	1140	1140	887	887	887	1286	1286	1031	1031	
		Ap	0.08	0.08	0.05	0.05	0.05	0.05	0.03	0.175	0.175	0.1	0.1	
	40	Vc	105	105	105	105	93	93	93	115	115	103	103	
		fz	0.081	0.081	0.081	0.081	0.072	0.072	0.072	0.1	0.1	0.09	0.09	
		RPM	8356	8356	8356	8356	7401	7401	7401	7321	7321	6557	6557	
		FEED	1354	1354	1354	1354	1066	1066	1066	1464	1464	1180	1180	
		Ap	0.112	0.112	0.07	0.07	0.07	0.07	0.042	0.245	0.245	0.14	0.14	
41	Vc	93	93	93	93	82	82	82	101	101	90	90		
	fz	0.077	0.077	0.077	0.077	0.068	0.068	0.068	0.1	0.1	0.09	0.09		
	RPM	7401	7401	7401	7401	6525	6525	6525	6430	6430	5730	5730		
	FEED	1140	1140	1140	1140	887	887	887	1286	1286	1031	1031		
	Ap	0.08	0.08	0.05	0.05	0.05	0.05	0.03	0.175	0.175	0.1	0.1		

▶ NEXT PAGE

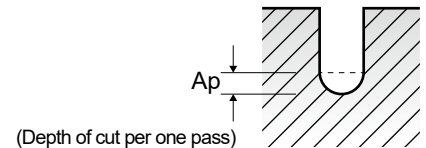

RECOMMENDED CUTTING CONDITIONS
EMPFOHLENE SCHNEIDPARAMETER

SEM846 SERIES **2 FLUTE BALL NOSE - SLOTTING**

Vc = m/min. fz = mm/tooth
RPM = rev./min. FEED = mm/min.
Ap = mm LBS = Length Below Shank

VDI 3323	Parameter	Diameter (Ø)													
		5.0	5.0	5.0	5.0	6.0	6.0	8.0	8.0	10.0	10.0	12.0	12.0	12.0	
	LBS	35	40	50	60	20	30	25	30	30	40	32	45	50	
1-5	Vc	109	109	109	97	123	123	122	122	121	121	121	121	100	
	fz	0.108	0.108	0.108	0.096	0.146	0.146	0.186	0.186	0.214	0.214	0.238	0.238	0.151	
	RPM	6939	6939	6939	6175	6525	6525	4854	4854	3852	3852	3210	3210	2653	
	FEED	1499	1499	1499	1186	1905	1905	1806	1806	1648	1648	1528	1528	801	
	Ap	0.18	0.18	0.113	0.113	0.378	0.378	0.504	0.504	0.9	0.63	1.08	0.756	0.756	
6-8	Vc	109	109	109	97	123	123	122	122	121	121	121	121	100	
	fz	0.108	0.108	0.108	0.096	0.146	0.146	0.186	0.186	0.214	0.214	0.238	0.238	0.151	
	RPM	6939	6939	6939	6175	6525	6525	4854	4854	3852	3852	3210	3210	2653	
	FEED	1499	1499	1499	1186	1905	1905	1806	1806	1648	1648	1528	1528	801	
	Ap	0.18	0.18	0.113	0.113	0.378	0.378	0.504	0.504	0.9	0.63	1.08	0.756	0.756	
9	Vc	103	103	103	92	117	117	116	116	116	116	115	115	95	
	fz	0.09	0.09	0.09	0.08	0.129	0.129	0.163	0.163	0.19	0.19	0.213	0.213	0.119	
	RPM	6557	6557	6557	5857	6207	6207	4615	4615	3692	3692	3050	3050	2520	
	FEED	1180	1180	1180	937	1601	1601	1505	1505	1403	1403	1300	1300	600	
	Ap	0.14	0.14	0.088	0.088	0.294	0.294	0.392	0.392	0.7	0.49	0.84	0.588	0.588	
10 - 11.1	Vc	109	109	109	97	123	123	122	122	121	121	121	121	100	
	fz	0.108	0.108	0.108	0.096	0.146	0.146	0.186	0.186	0.214	0.214	0.238	0.238	0.151	
	RPM	6939	6939	6939	6175	6525	6525	4854	4854	3852	3852	3210	3210	2653	
	FEED	1499	1499	1499	1186	1905	1905	1806	1806	1648	1648	1528	1528	801	
	Ap	0.18	0.18	0.113	0.113	0.378	0.378	0.504	0.504	0.9	0.63	1.08	0.756	0.756	
11.2	Vc	103	103	103	92	117	117	116	116	116	116	115	115	95	
	fz	0.09	0.09	0.09	0.08	0.129	0.129	0.163	0.163	0.19	0.19	0.213	0.213	0.119	
	RPM	6557	6557	6557	5857	6207	6207	4615	4615	3692	3692	3050	3050	2520	
	FEED	1180	1180	1180	937	1601	1601	1505	1505	1403	1403	1300	1300	600	
	Ap	0.14	0.14	0.088	0.088	0.294	0.294	0.392	0.392	0.7	0.49	0.84	0.588	0.588	
15 - 20	Vc	109	109	109	97	123	123	122	122	121	121	121	121	100	
	fz	0.108	0.108	0.108	0.096	0.146	0.146	0.186	0.186	0.214	0.214	0.238	0.238	0.151	
	RPM	6939	6939	6939	6175	6525	6525	4854	4854	3852	3852	3210	3210	2653	
	FEED	1499	1499	1499	1186	1905	1905	1806	1806	1648	1648	1528	1528	801	
	Ap	0.18	0.18	0.113	0.113	0.378	0.378	0.504	0.504	0.9	0.63	1.08	0.756	0.756	
38.1 - 38.2	Vc	90	90	90	80	104	104	101	101	101	101	100	100	82	
	fz	0.09	0.09	0.09	0.08	0.121	0.121	0.16	0.16	0.188	0.188	0.208	0.208	0.08	
	RPM	5730	5730	5730	5093	5517	5517	4019	4019	3215	3215	2653	2653	2175	
	FEED	1031	1031	1031	815	1335	1335	1286	1286	1209	1209	1103	1103	348	
	Ap	0.1	0.1	0.063	0.063	0.21	0.21	0.28	0.28	0.5	0.35	0.6	0.42	0.42	
40	Vc	103	103	103	92	117	117	116	116	116	116	115	115	95	
	fz	0.09	0.09	0.09	0.08	0.129	0.129	0.163	0.163	0.19	0.19	0.213	0.213	0.119	
	RPM	6557	6557	6557	5857	6207	6207	4615	4615	3692	3692	3050	3050	2520	
	FEED	1180	1180	1180	937	1601	1601	1505	1505	1403	1403	1300	1300	600	
	Ap	0.14	0.14	0.088	0.088	0.294	0.294	0.392	0.392	0.7	0.49	0.84	0.588	0.588	
41	Vc	90	90	90	80	104	104	101	101	101	101	100	100	82	
	fz	0.09	0.09	0.09	0.08	0.121	0.121	0.16	0.16	0.188	0.188	0.208	0.208	0.08	
	RPM	5730	5730	5730	5093	5517	5517	4019	4019	3215	3215	2653	2653	2175	
	FEED	1031	1031	1031	815	1335	1335	1286	1286	1209	1209	1103	1103	348	
	Ap	0.1	0.1	0.063	0.063	0.21	0.21	0.28	0.28	0.5	0.35	0.6	0.42	0.42	

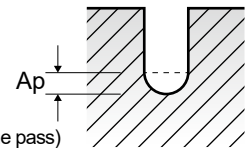

HSS

CBN END MILLS

i-Xmill END MILLS

i-SMART MODULAR END MILLS

X5070 END MILLS

4G MILL END MILLS

X-POWER PRO END MILLS

TitaNox-POWER END MILLS

JET-POWER END MILLS

V7 PLUS END MILLS

ALU-POWER HPC END MILLS

ALU-POWER END MILLS

D-POWER GRAPHITE END MILLS

D-POWER CFRP END MILLS

ROUTERS

CRX S END MILLS

K-2 END MILLS

ONLY ONE COATED PM60 END MILLS

TANK-POWER END MILLS

GENERAL HSS END MILLS

MILLING CUTTERS

TECHNICAL DATA

SEMD99 SERIES 2 FLUTE CORNER RADIUS - SLOTTING

Vc = m/min.
fz = mm/tooth
RPM = rev./min.
FEED = mm/min.

ISO	VDI 3323	Material Description	Ae	Ap	Parameter	Diameter (Ø)											
						0.2	0.3	0.4	0.5	0.6	0.7	0.8	0.9	1.0	1.2	1.5	
P	1-5	Non-alloy steel	1.0D	0.2D	Vc	28	39	52	57	57	66	75	85	87	93	104	
					fz	0.002	0.002	0.002	0.003	0.004	0.004	0.004	0.004	0.004	0.004	0.005	0.006
					RPM	44563	41380	41380	36287	30239	30012	29842	30063	27693	24669	22069	
	6-8	Low alloy steel	1.0D	0.2D	Vc	28	39	52	57	57	66	75	85	87	93	104	
					fz	0.002	0.002	0.002	0.003	0.004	0.004	0.004	0.004	0.004	0.005	0.006	
					RPM	44563	41380	41380	36287	30239	30012	29842	30063	27693	24669	22069	
	9	Low alloy steel	1.0D	0.2D	Vc	18	25	34	37	37	44	50	53	57	59	64	
					fz	0.001	0.001	0.001	0.002	0.002	0.002	0.002	0.002	0.003	0.003	0.004	
					RPM	28648	26526	27056	23555	19629	20008	19894	18745	18144	15650	13581	
	10-11.1	High alloyed steel, and tool steel	1.0D	0.2D	Vc	28	39	52	57	57	66	75	85	87	93	104	
					fz	0.002	0.002	0.002	0.003	0.004	0.004	0.004	0.004	0.004	0.005	0.006	
					RPM	44563	41380	41380	36287	30239	30012	29842	30063	27693	24669	22069	
11.2	High alloyed steel, and tool steel	1.0D	0.2D	Vc	18	25	34	37	37	44	50	53	57	59	64		
				fz	0.001	0.001	0.001	0.002	0.002	0.002	0.002	0.002	0.003	0.003	0.004		
				RPM	28648	26526	27056	23555	19629	20008	19894	18745	18144	15650	13581		
K	15-20	Grey cast iron Nodular cast iron Malleable cast iron	1.0D	0.2D	Vc	28	39	52	57	57	66	75	85	87	93	104	
					fz	0.002	0.002	0.002	0.003	0.004	0.004	0.004	0.004	0.004	0.005	0.006	
					RPM	44563	41380	41380	36287	30239	30012	29842	30063	27693	24669	22069	
H	38.1 - 38.2	Hardened steel	1.0D	0.2D	Vc	11	16	21	22	23	27	30	33	35	37	40	
					fz	0.001	0.001	0.001	0.002	0.002	0.002	0.002	0.002	0.003	0.003	0.004	
					RPM	17507	16977	16711	14006	12202	12278	11937	11671	11141	9815	8488	
H	40	Chilled Cast Iron	1.0D	0.2D	Vc	18	25	34	37	37	44	50	53	57	59	64	
					fz	0.001	0.001	0.001	0.002	0.002	0.002	0.002	0.002	0.003	0.003	0.004	
					RPM	28648	26526	27056	23555	19629	20008	19894	18745	18144	15650	13581	
H	41	Hardened Cast Iron	1.0D	0.2D	Vc	11	16	21	22	23	27	30	33	35	37	40	
					fz	0.001	0.001	0.001	0.002	0.002	0.002	0.002	0.002	0.003	0.003	0.004	
					RPM	17507	16977	16711	14006	12202	12278	11937	11671	11141	9815	8488	

▶ NEXT PAGE

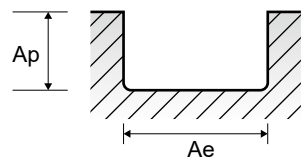

YG 4G MILL END MILLS

RECOMMENDED CUTTING CONDITIONS EMPFOHLENE SCHNEIDPARAMETER

Vc = m/min.
fz = mm/tooth
RPM = rev./min.
FEED = mm/min.

SEMD99 SERIES 2 FLUTE CORNER RADIUS - SLOTTING

VDI 3323	Parameter	Diameter (∅)																
		2.0	2.5	3.0	3.5	4.0	4.5	5.0	5.5	6.0	7.0	8.0	10.0	11.0	12.0	14.0	16.0	20.0
1-5	Vc	113	118	125	132	135	141	144	147	149	153	151	158	158	155	159	156	158
	fz	0.007	0.009	0.011	0.013	0.016	0.019	0.023	0.027	0.032	0.037	0.045	0.054	0.052	0.051	0.054	0.058	0.056
	RPM	17985	15024	13263	12005	10743	9974	9167	8508	7905	6957	6008	5029	4572	4112	3615	3104	2515
6-8	FEED	252	270	292	312	344	379	422	459	506	515	541	543	475	419	390	360	282
	Vc	113	118	125	132	135	141	144	147	149	153	151	158	158	155	159	156	158
	fz	0.007	0.009	0.011	0.013	0.016	0.019	0.023	0.027	0.032	0.037	0.045	0.054	0.052	0.051	0.054	0.058	0.056
9	RPM	17985	15024	13263	12005	10743	9974	9167	8508	7905	6957	6008	5029	4572	4112	3615	3104	2515
	FEED	252	270	292	312	344	379	422	459	506	515	541	543	475	419	390	360	282
	Vc	73	75	81	85	86	89	91	94	95	97	96	103	105	105	107	106	103
10	fz	0.005	0.007	0.008	0.01	0.012	0.015	0.017	0.021	0.025	0.028	0.033	0.038	0.04	0.041	0.041	0.04	0.037
	RPM	11618	9549	8594	7730	6844	6295	5793	5440	5040	4411	3820	3279	3038	2785	2433	2109	1639
	FEED	116	134	138	155	164	189	197	228	252	247	252	249	243	228	199	169	121
11.2	Vc	113	118	125	132	135	141	144	147	149	153	151	158	158	155	159	156	158
	fz	0.007	0.009	0.011	0.013	0.016	0.019	0.023	0.027	0.032	0.037	0.045	0.054	0.052	0.051	0.054	0.058	0.056
	RPM	17985	15024	13263	12005	10743	9974	9167	8508	7905	6957	6008	5029	4572	4112	3615	3104	2515
15 - 20	FEED	252	270	292	312	344	379	422	459	506	515	541	543	475	419	390	360	282
	Vc	113	118	125	132	135	141	144	147	149	153	151	158	158	155	159	156	158
	fz	0.007	0.009	0.011	0.013	0.016	0.019	0.023	0.027	0.032	0.037	0.045	0.054	0.052	0.051	0.054	0.058	0.056
38.1 - 38.2	RPM	17985	15024	13263	12005	10743	9974	9167	8508	7905	6957	6008	5029	4572	4112	3615	3104	2515
	FEED	252	270	292	312	344	379	422	459	506	515	541	543	475	419	390	360	282
	Vc	45	48	50	53	54	61	60	61	62	64	63	63	64	63	65	64	63
40	fz	0.005	0.006	0.007	0.008	0.009	0.01	0.013	0.016	0.018	0.021	0.024	0.03	0.03	0.03	0.03	0.031	0.03
	RPM	7162	6112	5305	4820	4297	4315	3820	3530	3289	2910	2507	2005	1852	1671	1478	1273	1003
	FEED	72	73	74	77	77	86	99	113	118	122	120	120	111	100	89	79	60
41	Vc	73	75	81	85	86	89	91	94	95	97	96	103	105	105	107	106	103
	fz	0.005	0.007	0.008	0.01	0.012	0.015	0.017	0.021	0.025	0.028	0.033	0.038	0.04	0.041	0.041	0.04	0.037
	RPM	11618	9549	8594	7730	6844	6295	5793	5440	5040	4411	3820	3279	3038	2785	2433	2109	1639
41	FEED	116	134	138	155	164	189	197	228	252	247	252	249	243	228	199	169	121
	Vc	45	48	50	53	54	61	60	61	62	64	63	63	64	63	65	64	63
	fz	0.005	0.006	0.007	0.008	0.009	0.01	0.013	0.016	0.018	0.021	0.024	0.03	0.03	0.03	0.03	0.031	0.03
41	RPM	7162	6112	5305	4820	4297	4315	3820	3530	3289	2910	2507	2005	1852	1671	1478	1273	1003
	FEED	72	73	74	77	77	86	99	113	118	122	120	120	111	100	89	79	60

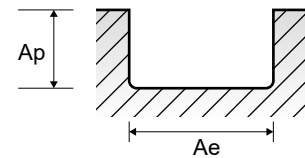

HSS

CBN END MILLS

i-Xmill END MILLS

i-SMART MODULAR END MILLS

X5070 END MILLS

4G MILL END MILLS

X-POWER PRO END MILLS

TitaNox-POWER END MILLS

JET-POWER END MILLS

V7 PLUS END MILLS

ALU-POWER HPC END MILLS

ALU-POWER END MILLS

D-POWER GRAPHITE END MILLS

D-POWER CFRP END MILLS

ROUTERS

CRX S END MILLS

K-2 END MILLS

ONLY ONE COATED PM60 END MILLS

TANK-POWER END MILLS

GENERAL HSS END MILLS

MILLING CUTTERS

TECHNICAL DATA

YG 4G MILL END MILLS

RECOMMENDED CUTTING CONDITIONS EMPFOLHENE SCHNEIDPARAMETER

SEME61 SERIES

2 FLUTE CORNER RADIUS - SLOTTING

Vc = m/min. fz = mm/tooth
RPM = rev./min. FEED = mm/min.
Ap = mm LBS = Length Below Shank

ISO	VDI 3323	Material Description	Parameter	Diameter (Ø)																																																																			
				0.2					0.3					0.4																																																									
				LBS	0.5	1	1.5	2	1	2	3	1	1.5	2	2.5	3																																																							
P	1-5	Non-alloy steel	Vc	31	31	28	28	47	42	42	63	63	63	57	57	fz	0.002	0.002	0.002	0.002	0.002	0.002	0.002	0.002	0.002	0.002	0.002	0.002	0.002	RPM	49338	49338	44563	44563	49869	44563	44563	50134	50134	50134	45359	45359	FEED	197	197	178	178	199	178	178	201	201	201	181	181	Ap	0.04	0.028	0.016	0.01	0.042	0.024	0.015	0.08	0.056	0.056	0.032	0.032			
			6-8	Low alloy steel	Vc	31	31	28	28	47	42	42	63	63	63	57	57	fz	0.002	0.002	0.002	0.002	0.002	0.002	0.002	0.002	0.002	0.002	0.002	0.002	RPM	49338	49338	44563	44563	49869	44563	44563	50134	50134	50134	45359	45359	FEED	197	197	178	178	199	178	178	201	201	201	181	181	Ap	0.04	0.028	0.016	0.01	0.042	0.024	0.015	0.08	0.056	0.056	0.032	0.032		
					9	High alloyed steel, and tool steel	Vc	22	22	20	20	30	27	27	40	40	40	36	36	fz	0.001	0.001	0.001	0.001	0.001	0.001	0.001	0.001	0.001	0.001	0.001	0.001	RPM	35014	35014	31831	31831	31831	28648	28648	31831	31831	31831	28648	28648	FEED	70	70	64	64	64	57	57	64	64	64	57	57	Ap	0.03	0.021	0.012	0.008	0.032	0.018	0.011	0.06	0.042	0.042	0.024	0.024
	10-11.1	High alloyed steel, and tool steel					Vc	31	31	28	28	47	42	42	63	63	63	57	57	fz	0.002	0.002	0.002	0.002	0.002	0.002	0.002	0.002	0.002	0.002	0.002	0.002	RPM	49338	49338	44563	44563	49869	44563	44563	50134	50134	50134	45359	45359	FEED	197	197	178	178	199	178	178	201	201	201	181	181	Ap	0.04	0.028	0.016	0.01	0.042	0.024	0.015	0.08	0.056	0.056	0.032	0.032
			11.2	High alloyed steel, and tool steel			Vc	22	22	20	20	30	27	27	40	40	40	36	36	fz	0.001	0.001	0.001	0.001	0.001	0.001	0.001	0.001	0.001	0.001	0.001	0.001	RPM	35014	35014	31831	31831	31831	28648	28648	31831	31831	31831	28648	28648	FEED	70	70	64	64	64	57	57	64	64	64	57	57	Ap	0.03	0.021	0.012	0.008	0.032	0.018	0.011	0.06	0.042	0.042	0.024	0.024
					K	15-20	Grey cast iron Nodular cast iron Malleable cast iron	Vc	31	31	28	28	47	42	42	63	63	63	57	57	fz	0.002	0.002	0.002	0.002	0.002	0.002	0.002	0.002	0.002	0.002	0.002	0.002	RPM	49338	49338	44563	44563	49869	44563	44563	50134	50134	50134	45359	45359	FEED	197	197	178	178	199	178	178	201	201	201	181	181	Ap	0.04	0.028	0.016	0.01	0.042	0.024	0.015	0.08	0.056	0.056	0.032
	H	38.1 - 38.2						Hardened steel	Vc	13	13	12	12	19	17	17	25	25	25	23	23	fz	0.001	0.001	0.001	0.001	0.001	0.001	0.001	0.001	0.001	0.001	0.001	0.001	RPM	20690	20690	19099	19099	20160	18038	18038	19894	19894	19894	18303	18303	FEED	41	41	38	38	40	36	36	40	40	40	37	37	Ap	0.024	0.017	0.01	0.006	0.025	0.014	0.009	0.048	0.034	0.034
			40	Chilled Cast Iron					Vc	22	22	20	20	30	27	27	40	40	40	36	36	fz	0.001	0.001	0.001	0.001	0.001	0.001	0.001	0.001	0.001	0.001	0.001	0.001	RPM	35014	35014	31831	31831	31831	28648	28648	31831	31831	31831	28648	28648	FEED	70	70	64	64	64	57	57	64	64	64	57	57	Ap	0.03	0.021	0.012	0.008	0.032	0.018	0.011	0.06	0.042	0.042
					41	Hardened Cast Iron	Vc		13	13	12	12	19	17	17	25	25	25	23	23	fz	0.001	0.001	0.001	0.001	0.001	0.001	0.001	0.001	0.001	0.001	0.001	0.001	RPM	20690	20690	19099	19099	20160	18038	18038	19894	19894	19894	18303	18303	FEED	41	41	38	38	40	36	36	40	40	40	37	37	Ap	0.024	0.017	0.01	0.006	0.025	0.014	0.009	0.048	0.034	0.034	0.019

▶ NEXT PAGE

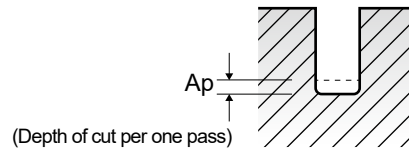

YG 4G MILL END MILLS

RECOMMENDED CUTTING CONDITIONS EMPFOHLENE SCHNEIDPARAMETER

SEME61 SERIES

2 FLUTE CORNER RADIUS - SLOTTING

Vc = m/min. fz = mm/tooth
RPM = rev./min. FEED = mm/min.
Ap = mm LBS = Length Below Shank

ISO	VDI 3323	Parameter	Diameter (Ø)														
			0.7	0.7	0.7	0.7	0.8	0.8	0.8	0.8	0.8	0.8	1.0	1.0	1.0	1.0	1.0
			LBS	4	6	8	10	2	3	4	6	8	10	3	4	6	8
P	1-5	Vc	72	72	64	64	91	91	91	82	82	73	104	104	94	94	94
		fz	0.003	0.003	0.003	0.003	0.003	0.003	0.003	0.003	0.003	0.003	0.004	0.004	0.004	0.004	0.004
		RPM	32740	32740	29103	29103	36208	36208	36208	32627	32627	29046	33104	33104	29921	29921	29921
	6-8	FEED	196	196	175	175	217	217	217	196	196	174	265	265	239	239	239
		Ap	0.056	0.035	0.035	0.021	0.16	0.112	0.112	0.064	0.04	0.04	0.2	0.14	0.08	0.08	0.05
		Vc	72	72	64	64	91	91	91	82	82	73	104	104	94	94	94
	9	fz	0.003	0.003	0.003	0.003	0.003	0.003	0.003	0.003	0.003	0.003	0.004	0.004	0.004	0.004	0.004
		RPM	32740	32740	29103	29103	36208	36208	36208	32627	32627	29046	33104	33104	29921	29921	29921
		FEED	196	196	175	175	217	217	217	196	196	174	265	265	239	239	239
	10-11.1	Ap	0.056	0.035	0.035	0.021	0.16	0.112	0.112	0.064	0.04	0.04	0.2	0.14	0.08	0.08	0.05
		Vc	48	48	42	42	60	60	60	54	54	48	68	68	61	61	61
		fz	0.002	0.002	0.002	0.002	0.002	0.002	0.002	0.002	0.002	0.002	0.003	0.003	0.002	0.002	0.002
11.2	RPM	21827	21827	19099	19099	23873	23873	23873	21486	21486	19099	21645	21645	19417	19417	19417	
	FEED	87	87	76	76	95	95	95	86	86	76	130	130	78	78	78	
	Ap	0.042	0.026	0.026	0.016	0.12	0.084	0.084	0.048	0.03	0.03	0.15	0.105	0.06	0.06	0.038	
K	15-20	Vc	72	72	64	64	91	91	91	82	82	73	104	104	94	94	94
		fz	0.003	0.003	0.003	0.003	0.003	0.003	0.003	0.003	0.003	0.003	0.004	0.004	0.004	0.004	0.004
		RPM	32740	32740	29103	29103	36208	36208	36208	32627	32627	29046	33104	33104	29921	29921	29921
H	38.1 - 38.2	FEED	196	196	175	175	217	217	217	196	196	174	265	265	239	239	239
		Ap	0.056	0.035	0.035	0.021	0.16	0.112	0.112	0.064	0.04	0.04	0.2	0.14	0.08	0.08	0.05
		Vc	29	29	26	26	36	36	36	33	33	29	41	41	37	37	37
40	fz	0.002	0.002	0.002	0.002	0.002	0.002	0.002	0.002	0.002	0.002	0.003	0.003	0.002	0.002	0.002	
	RPM	13187	13187	11823	11823	14324	14324	14324	13130	13130	11539	13051	13051	11777	11777	11777	
	FEED	53	53	47	47	57	57	57	53	53	46	78	78	47	47	47	
41	Ap	0.034	0.021	0.021	0.013	0.096	0.067	0.067	0.038	0.024	0.024	0.12	0.084	0.048	0.048	0.03	
	Vc	48	48	42	42	60	60	60	54	54	48	68	68	61	61	61	
	fz	0.002	0.002	0.002	0.002	0.002	0.002	0.002	0.002	0.002	0.002	0.003	0.003	0.002	0.002	0.002	
ROUTERS	CRX S END MILLS	RPM	21827	21827	19099	19099	23873	23873	23873	21486	21486	19099	21645	21645	19417	19417	19417
		FEED	87	87	76	76	95	95	95	86	86	76	130	130	78	78	78
		Ap	0.042	0.026	0.026	0.016	0.12	0.084	0.084	0.048	0.03	0.03	0.15	0.105	0.06	0.06	0.038
K-2 END MILLS	ONLY ONE COATED PM60 END MILLS	Vc	29	29	26	26	36	36	36	33	33	29	41	41	37	37	37
		fz	0.002	0.002	0.002	0.002	0.002	0.002	0.002	0.002	0.002	0.002	0.003	0.003	0.002	0.002	0.002
		RPM	13187	13187	11823	11823	14324	14324	14324	13130	13130	11539	13051	13051	11777	11777	11777
TANK-POWER END MILLS	GENERAL HSS END MILLS	FEED	53	53	47	47	57	57	57	53	53	46	78	78	47	47	47
		Ap	0.034	0.021	0.021	0.013	0.096	0.067	0.067	0.038	0.024	0.024	0.12	0.084	0.048	0.048	0.03
		Vc	48	48	42	42	60	60	60	54	54	48	68	68	61	61	61
MILLING CUTTERS	TECHNICAL DATA	fz	0.002	0.002	0.002	0.002	0.002	0.002	0.002	0.002	0.002	0.002	0.003	0.003	0.002	0.002	0.002
		RPM	13187	13187	11823	11823	14324	14324	14324	13130	13130	11539	13051	13051	11777	11777	11777
		FEED	53	53	47	47	57	57	57	53	53	46	78	78	47	47	47

▶ NEXT PAGE

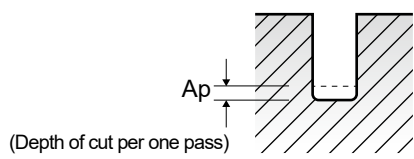

SEME61 SERIES 2 FLUTE CORNER RADIUS - SLOTTING

Vc = m/min. fz = mm/tooth
RPM = rev./min. FEED = mm/min.
Ap = mm LBS = Length Below Shank

ISO	VDI 3323	Parameter	Diameter (Ø)															
			1.5	1.5	1.5	1.5	1.5	1.5	1.5	2.0	2.0	2.0	2.0	2.0	2.0	2.0	2.0	2.0
		LBS	12	14	16	20	22	26	6	8	10	12	14	16	20	22	26	
P	1-5	Vc	112	112	100	100	100	75	136	136	136	122	122	122	122	109	109	
		fz	0.005	0.005	0.004	0.004	0.004	0.004	0.004	0.007	0.007	0.007	0.006	0.006	0.006	0.006	0.006	
		RPM	23767	23767	21221	21221	21221	15915	21645	21645	21645	19417	19417	19417	19417	17348	17348	
		FEED	238	238	170	170	170	127	303	303	303	233	233	233	233	208	208	
	6-8	Ap	0.12	0.075	0.075	0.045	0.045	0.03	0.4	0.28	0.28	0.16	0.16	0.16	0.1	0.1	0.1	
		Vc	112	112	100	100	100	75	136	136	136	122	122	122	122	109	109	
		fz	0.005	0.005	0.004	0.004	0.004	0.004	0.007	0.007	0.007	0.006	0.006	0.006	0.006	0.006	0.006	
		RPM	23767	23767	21221	21221	21221	15915	21645	21645	21645	19417	19417	19417	19417	17348	17348	
	9	FEED	238	238	170	170	170	127	303	303	303	233	233	233	233	208	208	
		Ap	0.12	0.075	0.075	0.045	0.045	0.03	0.4	0.28	0.28	0.16	0.16	0.16	0.1	0.1	0.1	
		Vc	69	69	61	61	61	46	87	87	87	78	78	78	78	69	69	
		fz	0.004	0.004	0.003	0.003	0.003	0.003	0.005	0.005	0.005	0.005	0.005	0.005	0.005	0.004	0.004	
	10-11.1	RPM	14642	14642	12945	12945	12945	9762	13846	13846	13846	12414	12414	12414	12414	10982	10982	
		FEED	117	117	78	78	78	59	138	138	138	124	124	124	124	88	88	
		Ap	0.09	0.056	0.056	0.034	0.034	0.023	0.3	0.21	0.21	0.12	0.12	0.12	0.12	0.075	0.075	
		Vc	112	112	100	100	100	75	136	136	136	122	122	122	122	109	109	
	11.2	fz	0.005	0.005	0.004	0.004	0.004	0.004	0.007	0.007	0.007	0.006	0.006	0.006	0.006	0.006	0.006	
		RPM	23767	23767	21221	21221	21221	15915	21645	21645	21645	19417	19417	19417	19417	17348	17348	
		FEED	238	238	170	170	170	127	303	303	303	233	233	233	233	208	208	
		Ap	0.12	0.075	0.075	0.045	0.045	0.03	0.4	0.28	0.28	0.16	0.16	0.16	0.16	0.1	0.1	
K	15-20	Vc	69	69	61	61	61	46	87	87	87	78	78	78	78	69	69	
		fz	0.004	0.004	0.003	0.003	0.003	0.003	0.005	0.005	0.005	0.005	0.005	0.005	0.005	0.004	0.004	
		RPM	14642	14642	12945	12945	12945	9762	13846	13846	13846	12414	12414	12414	12414	10982	10982	
		FEED	117	117	78	78	78	59	138	138	138	124	124	124	124	88	88	
H	38.1 - 38.2	Ap	0.09	0.056	0.056	0.034	0.034	0.023	0.3	0.21	0.21	0.12	0.12	0.12	0.12	0.075	0.075	
		Vc	43	43	38	38	38	29	54	54	54	49	49	49	49	43	43	
		fz	0.003	0.003	0.003	0.003	0.003	0.002	0.005	0.005	0.005	0.004	0.004	0.004	0.004	0.004	0.004	
		RPM	9125	9125	8064	8064	8064	6154	8594	8594	8594	7799	7799	7799	7799	6844	6844	
H	40	FEED	55	55	48	48	48	25	86	86	86	62	62	62	62	55	55	
		Ap	0.072	0.045	0.045	0.027	0.027	0.018	0.24	0.168	0.168	0.096	0.096	0.096	0.06	0.06	0.06	
		Vc	69	69	61	61	61	46	87	87	87	78	78	78	78	69	69	
		fz	0.004	0.004	0.003	0.003	0.003	0.003	0.005	0.005	0.005	0.005	0.005	0.005	0.005	0.004	0.004	
H	41	RPM	14642	14642	12945	12945	12945	9762	13846	13846	13846	12414	12414	12414	12414	10982	10982	
		FEED	117	117	78	78	78	59	138	138	138	124	124	124	124	88	88	
		Ap	0.09	0.056	0.056	0.034	0.034	0.023	0.3	0.21	0.21	0.12	0.12	0.12	0.12	0.075	0.075	
		Vc	43	43	38	38	38	29	54	54	54	49	49	49	49	43	43	
H	41	fz	0.003	0.003	0.003	0.003	0.003	0.002	0.005	0.005	0.005	0.004	0.004	0.004	0.004	0.004	0.004	
		RPM	9125	9125	8064	8064	8064	6154	8594	8594	8594	7799	7799	7799	7799	6844	6844	
		FEED	55	55	48	48	48	25	86	86	86	62	62	62	62	55	55	
		Ap	0.072	0.045	0.045	0.027	0.027	0.018	0.24	0.168	0.168	0.096	0.096	0.096	0.06	0.06	0.06	

▶ NEXT PAGE

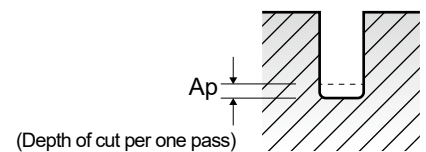

SEME61 SERIES 2 FLUTE CORNER RADIUS - SLOTTING

Vc = m/min. fz = mm/tooth
RPM = rev./min. FEED = mm/min.
Ap = mm LBS = Length Below Shank

VDI 3323	Parameter	Diameter (Ø)															
		2.0	2.5	2.5	2.5	2.5	2.5	2.5	2.5	2.5	3.0	3.0	3.0	3.0	3.0	3.0	3.0
	LBS	30	8	10	12	14	16	20	26	30	8	10	12	14	16	20	26
1-5	Vc	109	141	141	141	127	127	127	113	113	150	150	150	150	135	135	135
	fz	0.006	0.009	0.009	0.009	0.008	0.008	0.008	0.007	0.007	0.01	0.01	0.01	0.01	0.009	0.009	0.009
	RPM	17348	17953	17953	17953	16170	16170	16170	14388	14388	15915	15915	15915	15915	14324	14324	14324
	FEED	208	323	323	323	259	259	259	201	201	318	318	318	318	258	258	258
	Ap	0.06	0.35	0.35	0.35	0.2	0.2	0.2	0.125	0.125	0.6	0.42	0.42	0.42	0.24	0.24	0.15
6-8	Vc	109	141	141	141	127	127	127	113	113	150	150	150	150	135	135	135
	fz	0.006	0.009	0.009	0.009	0.008	0.008	0.008	0.007	0.007	0.01	0.01	0.01	0.01	0.009	0.009	0.009
	RPM	17348	17953	17953	17953	16170	16170	16170	14388	14388	15915	15915	15915	15915	14324	14324	14324
	FEED	208	323	323	323	259	259	259	201	201	318	318	318	318	258	258	258
	Ap	0.06	0.35	0.35	0.35	0.2	0.2	0.2	0.125	0.125	0.6	0.42	0.42	0.42	0.24	0.24	0.15
9	Vc	69	90	90	90	81	81	81	72	72	97	97	97	97	87	87	87
	fz	0.004	0.007	0.007	0.007	0.006	0.006	0.006	0.005	0.005	0.008	0.008	0.008	0.008	0.007	0.007	0.007
	RPM	10982	11459	11459	11459	10313	10313	10313	9167	9167	10292	10292	10292	10292	9231	9231	9231
	FEED	88	160	160	160	124	124	124	92	92	165	165	165	165	129	129	129
	Ap	0.045	0.263	0.263	0.263	0.15	0.15	0.15	0.094	0.094	0.45	0.315	0.315	0.315	0.18	0.18	0.113
10 - 11.1	Vc	109	141	141	141	127	127	127	113	113	150	150	150	150	135	135	135
	fz	0.006	0.009	0.009	0.009	0.008	0.008	0.008	0.007	0.007	0.01	0.01	0.01	0.01	0.009	0.009	0.009
	RPM	17348	17953	17953	17953	16170	16170	16170	14388	14388	15915	15915	15915	15915	14324	14324	14324
	FEED	208	323	323	323	259	259	259	201	201	318	318	318	318	258	258	258
	Ap	0.06	0.35	0.35	0.35	0.2	0.2	0.2	0.125	0.125	0.6	0.42	0.42	0.42	0.24	0.24	0.15
11.2	Vc	69	90	90	90	81	81	81	72	72	97	97	97	97	87	87	87
	fz	0.004	0.007	0.007	0.007	0.006	0.006	0.006	0.005	0.005	0.008	0.008	0.008	0.008	0.007	0.007	0.007
	RPM	10982	11459	11459	11459	10313	10313	10313	9167	9167	10292	10292	10292	10292	9231	9231	9231
	FEED	88	160	160	160	124	124	124	92	92	165	165	165	165	129	129	129
	Ap	0.045	0.263	0.263	0.263	0.15	0.15	0.15	0.094	0.094	0.45	0.315	0.315	0.315	0.18	0.18	0.113
15 - 20	Vc	109	141	141	141	127	127	127	113	113	150	150	150	150	135	135	135
	fz	0.006	0.009	0.009	0.009	0.008	0.008	0.008	0.007	0.007	0.01	0.01	0.01	0.01	0.009	0.009	0.009
	RPM	17348	17953	17953	17953	16170	16170	16170	14388	14388	15915	15915	15915	15915	14324	14324	14324
	FEED	208	323	323	323	259	259	259	201	201	318	318	318	318	258	258	258
	Ap	0.06	0.35	0.35	0.35	0.2	0.2	0.2	0.125	0.125	0.6	0.42	0.42	0.42	0.24	0.24	0.15
38.1 - 38.2	Vc	43	57	57	57	52	52	52	46	46	59	59	59	59	53	53	53
	fz	0.004	0.005	0.005	0.005	0.005	0.005	0.005	0.004	0.004	0.006	0.006	0.006	0.006	0.006	0.006	0.006
	RPM	6844	7257	7257	7257	6621	6621	6621	5857	5857	6260	6260	6260	6260	5623	5623	5623
	FEED	55	73	73	73	66	66	66	47	47	75	75	75	75	67	67	67
40	Vc	69	90	90	90	81	81	81	72	72	97	97	97	97	87	87	87
	fz	0.004	0.007	0.007	0.007	0.006	0.006	0.006	0.005	0.005	0.008	0.008	0.008	0.008	0.007	0.007	0.007
	RPM	10982	11459	11459	11459	10313	10313	10313	9167	9167	10292	10292	10292	10292	9231	9231	9231
	FEED	88	160	160	160	124	124	124	92	92	165	165	165	165	129	129	129
	Ap	0.045	0.263	0.263	0.263	0.15	0.15	0.15	0.094	0.094	0.45	0.315	0.315	0.315	0.18	0.18	0.113
41	Vc	43	57	57	57	52	52	52	46	46	59	59	59	59	53	53	53
	fz	0.004	0.005	0.005	0.005	0.005	0.005	0.005	0.004	0.004	0.006	0.006	0.006	0.006	0.006	0.006	0.006
	RPM	6844	7257	7257	7257	6621	6621	6621	5857	5857	6260	6260	6260	6260	5623	5623	5623
	FEED	55	73	73	73	66	66	66	47	47	75	75	75	75	67	67	67
	Ap	0.036	0.21	0.21	0.21	0.12	0.12	0.12	0.075	0.075	0.36	0.252	0.252	0.252	0.144	0.144	0.09

▶ NEXT PAGE

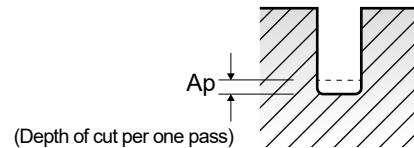

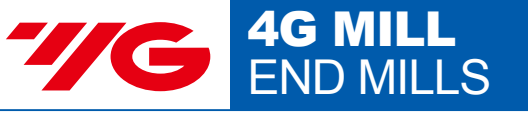

RECOMMENDED CUTTING CONDITIONS
EMPFOHLENE SCHNEIDPARAMETER

SEME61 SERIES 2 FLUTE CORNER RADIUS - SLOTTING

Vc = m/min. fz = mm/tooth
RPM = rev./min. FEED = mm/min.
Ap = mm LBS = Length Below Shank

ISO	VDI 3323	Parameter	Diameter (Ø)													
			3.0	3.0	3.0	4.0	4.0	4.0	4.0	4.0	4.0	4.0	4.0	4.0	4.0	4.0
			LBS	30	35	40	10	12	14	16	20	26	30	35	40	45
P	1-5	Vc	135	120	120	161	161	161	161	161	145	145	145	145	129	
		fz	0.009	0.008	0.008	0.016	0.016	0.016	0.016	0.016	0.014	0.014	0.014	0.014	0.012	
		RPM	14324	12732	12732	12812	12812	12812	12812	12812	11539	11539	11539	11539	10265	
		FEED	258	204	204	410	410	410	410	410	323	323	323	323	246	
	6-8	Ap	0.15	0.15	0.09	0.8	0.8	0.56	0.56	0.56	0.32	0.32	0.2	0.2	0.2	
		Vc	135	120	120	161	161	161	161	161	145	145	145	145	129	
		fz	0.009	0.008	0.008	0.016	0.016	0.016	0.016	0.016	0.014	0.014	0.014	0.014	0.012	
		RPM	14324	12732	12732	12812	12812	12812	12812	12812	11539	11539	11539	11539	10265	
	9	FEED	258	204	204	410	410	410	410	410	323	323	323	323	246	
		Ap	0.15	0.15	0.09	0.8	0.8	0.56	0.56	0.56	0.32	0.32	0.2	0.2	0.2	
		Vc	87	78	78	103	103	103	103	103	93	93	93	93	82	
		fz	0.007	0.006	0.006	0.012	0.012	0.012	0.012	0.012	0.011	0.011	0.011	0.011	0.01	
10-11.1	RPM	9231	8276	8276	8196	8196	8196	8196	8196	7401	7401	7401	7401	6525		
	FEED	129	99	99	197	197	197	197	197	163	163	163	163	131		
	Ap	0.113	0.113	0.068	0.6	0.6	0.42	0.42	0.42	0.24	0.24	0.15	0.15	0.15		
	Vc	135	120	120	161	161	161	161	161	145	145	145	145	129		
11.2	fz	0.009	0.008	0.008	0.016	0.016	0.016	0.016	0.016	0.014	0.014	0.014	0.014	0.012		
	RPM	14324	12732	12732	12812	12812	12812	12812	12812	11539	11539	11539	11539	10265		
	FEED	258	204	204	410	410	410	410	410	323	323	323	323	246		
	Ap	0.15	0.15	0.09	0.8	0.8	0.56	0.56	0.56	0.32	0.32	0.2	0.2	0.2		
K	15-20	Vc	87	78	78	103	103	103	103	103	93	93	93	93	82	
		fz	0.007	0.006	0.006	0.012	0.012	0.012	0.012	0.012	0.011	0.011	0.011	0.011	0.01	
		RPM	9231	8276	8276	8196	8196	8196	8196	8196	7401	7401	7401	7401	6525	
		FEED	129	99	99	197	197	197	197	197	163	163	163	163	131	
H	38.1 - 38.2	Ap	0.113	0.113	0.068	0.6	0.6	0.42	0.42	0.42	0.24	0.24	0.15	0.15	0.15	
		Vc	135	120	120	161	161	161	161	161	145	145	145	145	129	
		fz	0.009	0.008	0.008	0.016	0.016	0.016	0.016	0.016	0.014	0.014	0.014	0.014	0.012	
		RPM	14324	12732	12732	12812	12812	12812	12812	12812	11539	11539	11539	11539	10265	
H	40	FEED	258	204	204	410	410	410	410	410	323	323	323	323	246	
		Ap	0.15	0.15	0.09	0.8	0.8	0.56	0.56	0.56	0.32	0.32	0.2	0.2	0.2	
		Vc	87	78	78	103	103	103	103	103	93	93	93	93	82	
		fz	0.007	0.006	0.006	0.012	0.012	0.012	0.012	0.012	0.011	0.011	0.011	0.011	0.01	
H	41	RPM	9231	8276	8276	8196	8196	8196	8196	8196	7401	7401	7401	7401	6525	
		FEED	129	99	99	197	197	197	197	197	163	163	163	163	131	
		Ap	0.113	0.113	0.068	0.6	0.6	0.42	0.42	0.42	0.24	0.24	0.15	0.15	0.15	
		Vc	53	48	48	65	65	65	65	65	58	58	58	58	52	
Routers		fz	0.006	0.005	0.005	0.009	0.009	0.009	0.009	0.009	0.008	0.008	0.008	0.008	0.007	
		RPM	5623	5093	5093	5173	5173	5173	5173	5173	4615	4615	4615	4615	4138	
		FEED	67	51	51	93	93	93	93	93	74	74	74	74	58	
		Ap	0.09	0.09	0.054	0.48	0.48	0.336	0.336	0.336	0.192	0.192	0.12	0.12	0.12	
Routers		Vc	87	78	78	103	103	103	103	103	93	93	93	93	82	
		fz	0.007	0.006	0.006	0.012	0.012	0.012	0.012	0.012	0.011	0.011	0.011	0.011	0.01	
		RPM	9231	8276	8276	8196	8196	8196	8196	8196	7401	7401	7401	7401	6525	
		FEED	129	99	99	197	197	197	197	197	163	163	163	163	131	
Routers		Ap	0.113	0.113	0.068	0.6	0.6	0.42	0.42	0.42	0.24	0.24	0.15	0.15	0.15	
		Vc	53	48	48	65	65	65	65	65	58	58	58	58	52	
		fz	0.006	0.005	0.005	0.009	0.009	0.009	0.009	0.009	0.008	0.008	0.008	0.008	0.007	
		RPM	5623	5093	5093	5173	5173	5173	5173	5173	4615	4615	4615	4615	4138	
Routers		FEED	67	51	51	93	93	93	93	93	74	74	74	74	58	
		Ap	0.09	0.09	0.054	0.48	0.48	0.336	0.336	0.336	0.192	0.192	0.12	0.12	0.12	

▶ NEXT PAGE

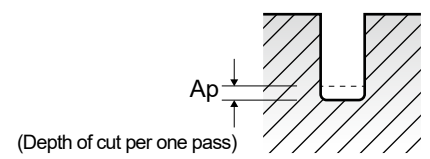

SEME61 SERIES

2 FLUTE CORNER RADIUS - SLOTTING

Vc = m/min. fz = mm/tooth
RPM = rev./min. FEED = mm/min.
Ap = mm LBS = Length Below Shank

VDI 3323	Parameter	Diameter (Ø)														
		4.0	5.0	6.0	6.0	8.0	8.0	10.0	10.0	12.0	12.0	16.0	16.0	20.0	20.0	
	LBS	50	15	20	30	25	35	30	40	32	45	35	50	40	55	
1-5	Vc	129	173	179	179	181	181	188	188	188	188	187	187	188	188	
	fz	0.012	0.023	0.032	0.032	0.044	0.044	0.053	0.053	0.05	0.05	0.06	0.06	0.055	0.055	
	RPM	10265	11014	9496	9496	7202	7202	5984	5984	4987	4987	3720	3720	2992	2992	
	FEED	246	507	608	608	634	634	634	634	499	499	446	446	329	329	
	Ap	0.2	1	0.84	0.84	1.12	1.12	2	1.4	2.4	1.68	3.2	2.24	4	4	
6-8	Vc	129	173	179	179	181	181	188	188	188	188	187	187	188	188	
	fz	0.012	0.023	0.032	0.032	0.044	0.044	0.053	0.053	0.05	0.05	0.06	0.06	0.055	0.055	
	RPM	10265	11014	9496	9496	7202	7202	5984	5984	4987	4987	3720	3720	2992	2992	
	FEED	246	507	608	608	634	634	634	634	499	499	446	446	329	329	
	Ap	0.2	1	0.84	0.84	1.12	1.12	2	1.4	2.4	1.68	3.2	2.24	4	4	
9	Vc	82	110	113	113	114	114	126	126	126	126	127	127	123	123	
	fz	0.01	0.017	0.025	0.025	0.033	0.033	0.038	0.038	0.04	0.04	0.042	0.042	0.036	0.036	
	RPM	6525	7003	5995	5995	4536	4536	4011	4011	3342	3342	2527	2527	1958	1958	
	FEED	131	238	300	300	299	299	305	305	267	267	212	212	141	141	
	Ap	0.15	0.75	0.63	0.63	0.84	0.84	1.5	1.05	1.8	1.26	2.4	1.68	3	3	
10 - 11.1	Vc	129	173	179	179	181	181	188	188	188	188	187	187	188	188	
	fz	0.012	0.023	0.032	0.032	0.044	0.044	0.053	0.053	0.05	0.05	0.06	0.06	0.055	0.055	
	RPM	10265	11014	9496	9496	7202	7202	5984	5984	4987	4987	3720	3720	2992	2992	
	FEED	246	507	608	608	634	634	634	634	499	499	446	446	329	329	
	Ap	0.2	1	0.84	0.84	1.12	1.12	2	1.4	2.4	1.68	3.2	2.24	4	4	
11.2	Vc	82	110	113	113	114	114	126	126	126	126	127	127	123	123	
	fz	0.01	0.017	0.025	0.025	0.033	0.033	0.038	0.038	0.04	0.04	0.042	0.042	0.036	0.036	
	RPM	6525	7003	5995	5995	4536	4536	4011	4011	3342	3342	2527	2527	1958	1958	
	FEED	131	238	300	300	299	299	305	305	267	267	212	212	141	141	
	Ap	0.15	0.75	0.63	0.63	0.84	0.84	1.5	1.05	1.8	1.26	2.4	1.68	3	3	
15 - 20	Vc	129	173	179	179	181	181	188	188	188	188	187	187	188	188	
	fz	0.012	0.023	0.032	0.032	0.044	0.044	0.053	0.053	0.05	0.05	0.06	0.06	0.055	0.055	
	RPM	10265	11014	9496	9496	7202	7202	5984	5984	4987	4987	3720	3720	2992	2992	
	FEED	246	507	608	608	634	634	634	634	499	499	446	446	329	329	
	Ap	0.2	1	0.84	0.84	1.12	1.12	2	1.4	2.4	1.68	3.2	2.24	4	4	
38.1 - 38.2	Vc	52	72	74	74	76	76	76	76	75	75	77	77	75	75	
	fz	0.007	0.013	0.018	0.018	0.023	0.023	0.029	0.029	0.03	0.03	0.031	0.031	0.029	0.029	
	RPM	4138	4584	3926	3926	3024	3024	2419	2419	1989	1989	1532	1532	1194	1194	
	FEED	58	119	141	141	139	139	140	140	119	119	95	95	69	69	
40	Vc	82	110	113	113	114	114	126	126	126	126	127	127	123	123	
	fz	0.01	0.017	0.025	0.025	0.033	0.033	0.038	0.038	0.04	0.04	0.042	0.042	0.036	0.036	
	RPM	6525	7003	5995	5995	4536	4536	4011	4011	3342	3342	2527	2527	1958	1958	
	FEED	131	238	300	300	299	299	305	305	267	267	212	212	141	141	
	Ap	0.15	0.75	0.63	0.63	0.84	0.84	1.5	1.05	1.8	1.26	2.4	1.68	3	3	
41	Vc	52	72	74	74	76	76	76	76	75	75	77	77	75	75	
	fz	0.007	0.013	0.018	0.018	0.023	0.023	0.029	0.029	0.03	0.03	0.031	0.031	0.029	0.029	
	RPM	4138	4584	3926	3926	3024	3024	2419	2419	1989	1989	1532	1532	1194	1194	
	FEED	58	119	141	141	139	139	140	140	119	119	95	95	69	69	
	Ap	0.12	0.6	0.504	0.504	0.672	0.672	1.2	0.84	1.44	1.008	1.92	1.344	2.4	2.4	

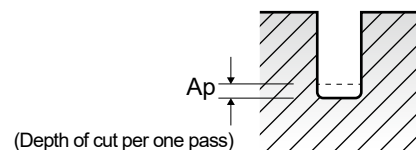

HSS

CBN
END MILLSi-Xmill
END MILLSi-SMART
MODULAR
END MILLSX5070
END MILLS4G MILL
END MILLSX-POWER
PRO
END MILLSTitanox-
POWER
END MILLSJET-POWER
END MILLSV7 PLUS
END MILLSALU-POWER
HPC
END MILLSALU-
POWER
END MILLSD-POWER
GRAPHITE
END MILLSD-POWER
CFRP
END MILLS

ROUTERS

CRX S
END MILLSK-2
END MILLSONLY ONE
COATED PM60
END MILLSTANK-
POWER
END MILLSGENERAL
HSS
END MILLSMILLING
CUTTERSTECHNICAL
DATA

SEME01 SERIES 4 FLUTE CORNER RADIUS - SIDE CUTTING

Vc = m/min.
fz = mm/tooth
RPM = rev./min.
FEED = mm/min.

ISO	VDI 3323	Material Description	Ae	Ap	Parameter	Diameter (Ø)							
						1.0	1.2	1.5	2.0	2.5	3.0	3.5	4.0
P	1-5	Non-alloy steel	0.05D	2D	Vc	87	93	104	113	118	125	132	135
					fz	0.003	0.003	0.004	0.004	0.006	0.006	0.008	0.01
					RPM	27693	24669	22069	17985	15024	13263	12005	10743
	6-8	Low alloy steel	0.05D	2D	Vc	87	93	104	113	118	125	132	135
					fz	0.003	0.003	0.004	0.004	0.006	0.006	0.008	0.01
					RPM	27693	24669	22069	17985	15024	13263	12005	10743
	9	Low alloy steel	0.05D	2D	Vc	57	59	64	73	75	81	85	86
					fz	0.003	0.004	0.004	0.005	0.007	0.008	0.009	0.011
					RPM	18144	15650	13581	11618	9549	8594	7730	6844
	10-11.1	High alloyed steel, and tool steel	0.05D	2D	Vc	87	93	104	113	118	125	132	135
					fz	0.003	0.003	0.004	0.004	0.006	0.006	0.008	0.01
					RPM	27693	24669	22069	17985	15024	13263	12005	10743
11.2	High alloyed steel, and tool steel	0.05D	2D	Vc	57	59	64	73	75	81	85	86	
				fz	0.003	0.004	0.004	0.005	0.007	0.008	0.009	0.011	
				RPM	18144	15650	13581	11618	9549	8594	7730	6844	
K	15-20	Grey cast iron Nodular cast iron Malleable cast iron	0.05D	2D	Vc	87	93	104	113	118	125	132	135
					fz	0.003	0.003	0.004	0.004	0.006	0.006	0.008	0.01
					RPM	27693	24669	22069	17985	15024	13263	12005	10743
H	38.1 - 38.2	Hardened steel	0.02D	2D	Vc	35	37	40	45	48	50	53	54
					fz	0.003	0.003	0.004	0.005	0.005	0.006	0.007	0.008
					RPM	11141	9815	8488	7162	6112	5305	4820	4297
H	40	Chilled Cast Iron	0.05D	2D	Vc	57	59	64	73	75	81	85	86
					fz	0.003	0.004	0.004	0.005	0.007	0.008	0.009	0.011
					RPM	18144	15650	13581	11618	9549	8594	7730	6844
H	41	Hardened Cast Iron	0.02D	2D	Vc	35	37	40	45	48	50	53	54
					fz	0.003	0.003	0.004	0.005	0.005	0.006	0.007	0.008
					RPM	11141	9815	8488	7162	6112	5305	4820	4297
						134	118	136	143	122	127	135	138

▶ NEXT PAGE

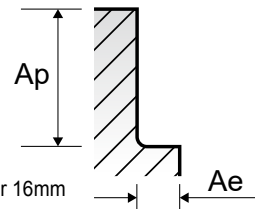

SEME01 SERIES **4 FLUTE CORNER RADIUS - SIDE CUTTING**

Vc = m/min.
fz = mm/tooth
RPM = rev./min.
FEED = mm/min.

VDI 3323	Parameter	Diameter (Ø)											
		4.5	5.0	5.5	6.0	7.0	8.0	10.0	11.0	12.0	14.0	16.0	20.0
1-5	Vc	141	144	147	149	153	151	158	158	155	159	156	158
	fz	0.011	0.012	0.013	0.014	0.016	0.019	0.023	0.022	0.022	0.022	0.023	0.023
	RPM	9974	9167	8508	7905	6957	6008	5029	4572	4112	3615	3104	2515
6-8	FEED	439	440	442	443	445	457	463	402	362	318	286	231
	Vc	141	144	147	149	153	151	158	158	155	159	156	158
	fz	0.011	0.012	0.013	0.014	0.016	0.019	0.023	0.022	0.022	0.022	0.023	0.023
9	RPM	9974	9167	8508	7905	6957	6008	5029	4572	4112	3615	3104	2515
	FEED	439	440	442	443	445	457	463	402	362	318	286	231
	Vc	89	91	94	95	97	96	103	105	105	107	106	103
10	fz	0.013	0.016	0.017	0.018	0.02	0.024	0.027	0.028	0.029	0.028	0.027	0.027
	RPM	6295	5793	5440	5040	4411	3820	3279	3038	2785	2433	2109	1639
	FEED	327	371	370	363	353	367	354	340	323	272	228	177
11.1	Vc	141	144	147	149	153	151	158	158	155	159	156	158
	fz	0.011	0.012	0.013	0.014	0.016	0.019	0.023	0.022	0.022	0.022	0.023	0.023
	RPM	9974	9167	8508	7905	6957	6008	5029	4572	4112	3615	3104	2515
11.2	FEED	439	440	442	443	445	457	463	402	362	318	286	231
	Vc	89	91	94	95	97	96	103	105	105	107	106	103
	fz	0.013	0.016	0.017	0.018	0.02	0.024	0.027	0.028	0.029	0.028	0.027	0.027
15 - 20	RPM	6295	5793	5440	5040	4411	3820	3279	3038	2785	2433	2109	1639
	FEED	327	371	370	363	353	367	354	340	323	272	228	177
	Vc	141	144	147	149	153	151	158	158	155	159	156	158
38.1 - 38.2	fz	0.011	0.012	0.013	0.014	0.016	0.019	0.023	0.022	0.022	0.022	0.023	0.023
	RPM	9974	9167	8508	7905	6957	6008	5029	4572	4112	3615	3104	2515
	FEED	439	440	442	443	445	457	463	402	362	318	286	231
40	Vc	57	60	61	62	64	63	63	64	63	65	64	63
	fz	0.01	0.011	0.012	0.013	0.015	0.017	0.021	0.021	0.021	0.021	0.022	0.023
	RPM	4032	3820	3530	3289	2910	2507	2005	1852	1671	1478	1273	1003
41	FEED	161	168	169	171	175	170	168	156	140	124	112	92
	Vc	89	91	94	95	97	96	103	105	105	107	106	103
	fz	0.013	0.016	0.017	0.018	0.02	0.024	0.027	0.028	0.029	0.028	0.027	0.027
40	RPM	6295	5793	5440	5040	4411	3820	3279	3038	2785	2433	2109	1639
	FEED	327	371	370	363	353	367	354	340	323	272	228	177
	Vc	57	60	61	62	64	63	63	64	63	65	64	63
41	fz	0.01	0.011	0.012	0.013	0.015	0.017	0.021	0.021	0.021	0.021	0.022	0.023
	RPM	4032	3820	3530	3289	2910	2507	2005	1852	1671	1478	1273	1003
	FEED	161	168	169	171	175	170	168	156	140	124	112	92

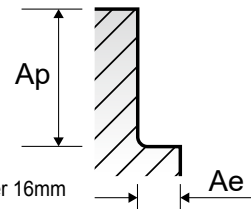

* 1.5XD Axial cutting depth should be for diameter over 16mm

HSS

CBN END MILLS

i-Xmill END MILLS

i-SMART MODULAR END MILLS

X5070 END MILLS

4G MILL END MILLS

X-POWER PRO END MILLS

TitaNox-POWER END MILLS

JET-POWER END MILLS

V7 PLUS END MILLS

ALU-POWER HPC END MILLS

ALU-POWER END MILLS

D-POWER GRAPHITE END MILLS

D-POWER CFRP END MILLS

ROUTERS

CRX S END MILLS

K-2 END MILLS

ONLY ONE COATED PM60 END MILLS

TANK-POWER END MILLS

GENERAL HSS END MILLS

MILLING CUTTERS

TECHNICAL DATA

YG 4G MILL END MILLS

RECOMMENDED CUTTING CONDITIONS EMPFOHLENE SCHNEIDPARAMETER

SEME64 SERIES

4 FLUTE CORNER RADIUS - SIDE CUTTING

Vc = m/min. fz = mm/tooth
RPM = rev./min. FEED = mm/min.
Ae = mm LBS = Length Below Shank

ISO	VDI 3323	Material Description	Parameter	Diameter (Ø)															
				1.0	1.0	1.0	1.0	1.0	1.0	1.0	1.0	1.0	1.0	1.2	1.2	1.2	1.2	1.2	1.2
				LBS	4	6	8	10	12	16	20	22	26	3	4	6	8	10	12
P	1-5	Non-alloy steel	Vc	104	94	94	94	83	62	62	31	112	112	112	101	101	101	90	
			fz	0.003	0.002	0.002	0.002	0.002	0.002	0.002	0.002	0.002	0.003	0.003	0.003	0.003	0.003	0.003	0.002
			RPM	33104	29921	29921	29921	26420	19735	19735	9868	9868	29709	29709	29709	26791	26791	26791	23873
			FEED	397	239	239	239	211	158	158	79	79	357	357	357	321	321	321	191
			Ae	0.021	0.012	0.012	0.008	0.008	0.005	0.003	0.003	0.003	0.036	0.025	0.025	0.014	0.009	0.009	0.005
	6-8	Low alloy steel	Vc	104	94	94	94	83	62	62	31	112	112	112	101	101	101	90	
			fz	0.003	0.002	0.002	0.002	0.002	0.002	0.002	0.002	0.002	0.003	0.003	0.003	0.003	0.003	0.003	0.002
			RPM	33104	29921	29921	29921	26420	19735	19735	9868	9868	29709	29709	29709	26791	26791	26791	23873
			FEED	397	239	239	239	211	158	158	79	79	357	357	357	321	321	321	191
			Ae	0.021	0.012	0.012	0.008	0.008	0.005	0.003	0.003	0.003	0.036	0.025	0.025	0.014	0.009	0.009	0.005
	9	High alloyed steel, and tool steel	Vc	68	61	61	61	54	41	41	20	20	71	71	71	64	64	64	57
			fz	0.003	0.003	0.003	0.003	0.002	0.002	0.002	0.002	0.002	0.004	0.004	0.004	0.004	0.003	0.003	0.003
			RPM	21645	19417	19417	19417	17189	13051	13051	6366	6366	18833	18833	18833	16977	16977	16977	15120
			FEED	260	233	233	233	138	104	104	51	51	301	301	301	204	204	204	181
			Ae	0.016	0.009	0.009	0.006	0.006	0.003	0.002	0.002	0.002	0.027	0.01	0.019	0.011	0.007	0.007	0.004
	10-11.1	High alloyed steel, and tool steel	Vc	104	94	94	94	83	62	62	31	112	112	112	101	101	101	90	
			fz	0.003	0.002	0.002	0.002	0.002	0.002	0.002	0.002	0.002	0.003	0.003	0.003	0.003	0.003	0.003	0.002
			RPM	33104	29921	29921	29921	26420	19735	19735	9868	9868	29709	29709	29709	26791	26791	26791	23873
			FEED	397	239	239	239	211	158	158	79	79	357	357	357	321	321	321	191
			Ae	0.021	0.012	0.012	0.008	0.008	0.005	0.003	0.003	0.003	0.036	0.025	0.025	0.014	0.009	0.009	0.005
11.2	High alloyed steel, and tool steel	Vc	68	61	61	61	54	41	41	20	20	71	71	71	64	64	64	57	
		fz	0.003	0.003	0.003	0.003	0.002	0.002	0.002	0.002	0.002	0.004	0.004	0.004	0.004	0.003	0.003	0.003	
		RPM	21645	19417	19417	19417	17189	13051	13051	6366	6366	18833	18833	18833	16977	16977	16977	15120	
		FEED	260	233	233	233	138	104	104	51	51	301	301	301	204	204	204	181	
		Ae	0.016	0.009	0.009	0.006	0.006	0.003	0.002	0.002	0.002	0.027	0.01	0.019	0.011	0.007	0.007	0.004	
K	15-20	Grey cast iron Nodular cast iron Malleable cast iron	Vc	104	94	94	94	83	62	62	31	112	112	112	101	101	101	90	
			fz	0.003	0.002	0.002	0.002	0.002	0.002	0.002	0.002	0.002	0.003	0.003	0.003	0.003	0.003	0.003	0.002
			RPM	33104	29921	29921	29921	26420	19735	19735	9868	9868	29709	29709	29709	26791	26791	26791	23873
			Ae	0.021	0.012	0.012	0.008	0.008	0.005	0.003	0.003	0.003	0.036	0.025	0.025	0.014	0.009	0.009	0.005
H	38.1 - 38.2	Hardened steel	Vc	41	37	37	37	33	25	25	12	12	44	44	44	40	40	35	
			fz	0.003	0.002	0.002	0.002	0.002	0.002	0.002	0.002	0.002	0.003	0.003	0.003	0.003	0.003	0.003	0.002
			RPM	13051	11777	11777	11777	10504	7958	7958	3820	3820	11671	11671	11671	10610	10610	10610	9284
			Ae	0.013	0.007	0.007	0.005	0.005	0.003	0.002	0.002	0.002	0.022	0.015	0.015	0.009	0.005	0.005	0.003
	40	Chilled Cast Iron	Vc	68	61	61	61	54	41	41	20	20	71	71	71	64	64	64	57
			fz	0.003	0.003	0.003	0.003	0.002	0.002	0.002	0.002	0.002	0.004	0.004	0.004	0.003	0.003	0.003	0.003
			RPM	21645	19417	19417	19417	17189	13051	13051	6366	6366	18833	18833	18833	16977	16977	16977	15120
			Ae	0.016	0.009	0.009	0.006	0.006	0.003	0.002	0.002	0.002	0.027	0.01	0.019	0.011	0.007	0.007	0.004
	41	Hardened Cast Iron	Vc	41	37	37	37	33	25	25	12	12	44	44	44	40	40	40	35
			fz	0.003	0.002	0.002	0.002	0.002	0.002	0.002	0.002	0.002	0.003	0.003	0.003	0.003	0.003	0.003	0.002
			RPM	13051	11777	11777	11777	10504	7958	7958	3820	3820	11671	11671	11671	10610	10610	10610	9284
			Ae	0.013	0.007	0.007	0.005	0.005	0.003	0.002	0.002	0.002	0.022	0.015	0.015	0.009	0.005	0.005	0.003

▶ NEXT PAGE

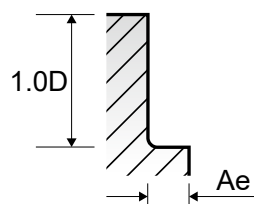

YG 4G MILL END MILLS

RECOMMENDED CUTTING CONDITIONS EMPFOHLENE SCHNEIDPARAMETER

SEME64 SERIES 4 FLUTE CORNER RADIUS - SIDE CUTTING

Vc = m/min. fz = mm/tooth
RPM = rev./min. FEED = mm/min.
Ae = mm LBS = Length Below Shank

ISO	VDI 3323	Parameter	Diameter (Ø)																				
			2.5	2.5	2.5	2.5	2.5	2.5	2.5	2.5	3.0	3.0	3.0	3.0	3.0	3.0	3.0	3.0	3.0	4.0	4.0		
			LBS	10	12	14	16	20	26	30	8	10	12	14	16	20	26	30	35	40	10	12	
P	1-5	Vc	141	141	127	127	127	113	113	150	150	150	150	135	135	135	135	135	120	120	161	161	
		fz	0.005	0.005	0.005	0.005	0.005	0.004	0.004	0.006	0.006	0.006	0.006	0.006	0.006	0.006	0.006	0.006	0.006	0.005	0.005	0.01	0.01
		RPM	17953	17953	16170	16170	16170	14388	14388	15915	15915	15915	15915	14324	14324	14324	14324	14324	12732	12732	12812	12812	
	6-8	FEED	359	359	323	323	323	230	230	382	382	382	382	344	344	344	344	344	255	255	512	512	
		Ae	0.053	0.053	0.03	0.03	0.03	0.019	0.019	0.09	0.063	0.063	0.063	0.036	0.036	0.036	0.023	0.023	0.023	0.014	0.014	0.12	0.12
		Vc	141	141	127	127	127	113	113	150	150	150	150	135	135	135	135	135	120	120	161	161	
	9	fz	0.005	0.005	0.005	0.005	0.005	0.004	0.004	0.006	0.006	0.006	0.006	0.006	0.006	0.006	0.006	0.006	0.006	0.005	0.005	0.01	0.01
		RPM	17953	17953	16170	16170	16170	14388	14388	15915	15915	15915	15915	14324	14324	14324	14324	14324	12732	12732	12812	12812	
		FEED	359	359	323	323	323	230	230	382	382	382	382	344	344	344	344	344	255	255	512	512	
	10-11.1	Ae	0.053	0.053	0.03	0.03	0.03	0.019	0.019	0.09	0.063	0.063	0.063	0.036	0.036	0.036	0.023	0.023	0.023	0.014	0.014	0.12	0.12
		Vc	141	141	127	127	127	113	113	150	150	150	150	135	135	135	135	135	120	120	161	161	
		fz	0.005	0.005	0.005	0.005	0.005	0.004	0.004	0.006	0.006	0.006	0.006	0.006	0.006	0.006	0.006	0.006	0.006	0.005	0.005	0.01	0.01
11.2	RPM	17953	17953	16170	16170	16170	14388	14388	15915	15915	15915	15915	14324	14324	14324	14324	14324	12732	12732	12812	12812		
	FEED	359	359	323	323	323	230	230	382	382	382	382	344	344	344	344	344	255	255	512	512		
	Ae	0.053	0.053	0.03	0.03	0.03	0.019	0.019	0.09	0.063	0.063	0.063	0.036	0.036	0.036	0.023	0.023	0.023	0.014	0.014	0.12	0.12	
K	15-20	Vc	90	90	81	81	81	72	72	97	97	97	97	87	87	87	87	87	78	78	103	103	
		fz	0.007	0.007	0.006	0.006	0.006	0.005	0.005	0.008	0.008	0.008	0.008	0.007	0.007	0.007	0.007	0.007	0.006	0.006	0.011	0.011	
		RPM	11459	11459	10313	10313	10313	9167	9167	10292	10292	10292	10292	9231	9231	9231	9231	9231	8276	8276	8196	8196	
H	38.1 - 38.2	FEED	321	321	248	248	248	183	183	329	329	329	329	258	258	258	258	199	199	361	361		
		Ae	0.039	0.039	0.023	0.023	0.023	0.014	0.014	0.068	0.047	0.047	0.047	0.027	0.027	0.027	0.017	0.017	0.017	0.01	0.01	0.09	0.09
		Vc	141	141	127	127	127	113	113	150	150	150	150	135	135	135	135	135	120	120	161	161	
40	fz	0.005	0.005	0.005	0.005	0.005	0.004	0.004	0.006	0.006	0.006	0.006	0.005	0.005	0.005	0.005	0.005	0.005	0.005	0.008	0.008		
	RPM	7257	7257	6621	6621	6621	5857	5857	6260	6260	6260	6260	5623	5623	5623	5623	5623	5093	5093	5173	5173		
	FEED	145	145	132	132	132	94	94	150	150	150	150	112	112	112	112	112	102	102	166	166		
41	Ae	0.032	0.032	0.018	0.018	0.018	0.011	0.011	0.054	0.038	0.038	0.038	0.022	0.022	0.022	0.014	0.014	0.014	0.008	0.008	0.072	0.072	
	Vc	90	90	81	81	81	72	72	97	97	97	97	87	87	87	87	87	78	78	103	103		
	fz	0.007	0.007	0.006	0.006	0.006	0.005	0.005	0.008	0.008	0.008	0.008	0.007	0.007	0.007	0.007	0.007	0.006	0.006	0.011	0.011		
D-POWER CFRP END MILLS	41	RPM	11459	11459	10313	10313	10313	9167	9167	10292	10292	10292	10292	9231	9231	9231	9231	9231	8276	8276	8196	8196	
		FEED	321	321	248	248	248	183	183	329	329	329	329	258	258	258	258	199	199	361	361		
		Ae	0.039	0.039	0.023	0.023	0.023	0.014	0.014	0.068	0.047	0.047	0.047	0.027	0.027	0.027	0.017	0.017	0.017	0.01	0.01	0.09	0.09

▶ NEXT PAGE

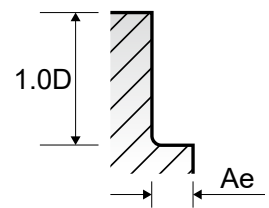

RECOMMENDED CUTTING CONDITIONS
EMPFOHLENE SCHNEIDPARAMETER

SEME64 SERIES 4 FLUTE CORNER RADIUS - **SIDE CUTTING**

Vc = m/min. fz = mm/tooth
RPM = rev./min. FEED = mm/min.
Ae = mm LBS = Length Below Shank

Table with 20 columns (Diameter Ø) and multiple rows (VDI 3323, Parameter, Vc, fz, RPM, FEED, Ae) for various mill series (1-5, 6-8, 9, 10-11.1, 11.2, 15-20, 38.1-38.2, 40, 41).

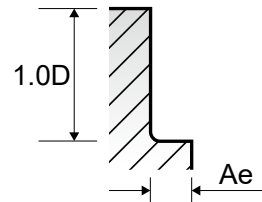

HSS

CBN END MILLS

i-Xmill END MILLS

i-SMART MODULAR END MILLS

X5070 END MILLS

4G MILL END MILLS

X-POWER PRO END MILLS

TitaNox-POWER END MILLS

JET-POWER END MILLS

V7 PLUS END MILLS

ALU-POWER HPC END MILLS

ALU-POWER END MILLS

D-POWER GRAPHITE END MILLS

D-POWER CFRP END MILLS

ROUTERS

CRX S END MILLS

K-2 END MILLS

ONLY ONE COATED PM60 END MILLS

TANK-POWER END MILLS

GENERAL HSS END MILLS

MILLING CUTTERS

TECHNICAL DATA

YG 4G MILL END MILLS

RECOMMENDED CUTTING CONDITIONS EMPFOHLENE SCHNEIDPARAMETER

SEME35 SERIES 2 FLUTE - SLOTTING

Vc = m/min.
fz = mm/tooth
RPM = rev./min.
FEED = mm/min.

ISO	VDI 3323	Material Description	Ae	Ap	Parameter	Diameter (Ø)								
						0.1	0.2	0.3	0.4	0.5	0.6	0.7	0.8	0.9
P	1-5	Non-alloy steel	1.0D	0.5D (up to Ø3: 0.2D) (up to Ø1: 0.15D)	Vc	13	26	37	49	57	60	62	63	66
					fz	0.001	0.001	0.001	0.001	0.002	0.002	0.003	0.003	0.004
	RPM	41380	41380	39258	38993	36287	31831	28193	25067	23343				
	FEED	83	83	79	78	145	127	169	150	187				
	6-8	Low alloy steel	1.0D	0.5D (up to Ø3: 0.2D) (up to Ø1: 0.15D)	Vc	13	26	37	49	57	60	62	63	66
fz					0.001	0.001	0.001	0.001	0.002	0.002	0.003	0.003	0.004	
RPM					41380	41380	39258	38993	36287	31831	28193	25067	23343	
9	High alloyed steel, and tool steel	1.0D	0.5D (up to Ø3: 0.2D) (up to Ø1: 0.15D)	Vc	8	16	22	29	34	36	37	38	40	
				fz	0.001	0.001	0.001	0.001	0.002	0.002	0.003	0.003	0.003	
				RPM	25465	25465	23343	23077	21645	19099	16825	15120	14147	
10-11.1	High alloyed steel, and tool steel	1.0D	0.5D (up to Ø3: 0.2D) (up to Ø1: 0.15D)	Vc	13	26	37	49	57	60	62	63	66	
				fz	0.001	0.001	0.001	0.001	0.002	0.002	0.003	0.003	0.004	
				RPM	41380	41380	39258	38993	36287	31831	28193	25067	23343	
11.2	High alloyed steel, and tool steel	1.0D	0.5D (up to Ø3: 0.2D) (up to Ø1: 0.15D)	Vc	8	16	22	29	34	36	37	38	40	
				fz	0.001	0.001	0.001	0.001	0.002	0.002	0.003	0.003	0.003	
				RPM	25465	25465	23343	23077	21645	19099	16825	15120	14147	
M	14.1	Stainless steel	1.0D	0.5D (up to Ø1: 0.02D)	Vc	7	13	18	25	28	30	31	31	33
					fz	0.001	0.001	0.001	0.001	0.002	0.002	0.003	0.003	0.003
					RPM	22282	20690	19099	19894	17825	15915	14097	12335	11671
K	15-20	Grey cast iron Nodular cast iron Malleable cast iron	1.0D	0.5D (up to Ø3: 0.2D) (up to Ø1: 0.15D)	Vc	13	26	37	49	57	60	62	63	66
					fz	0.001	0.001	0.001	0.001	0.002	0.002	0.003	0.003	0.004
					RPM	41380	41380	39258	38993	36287	31831	28193	25067	23343
H	38.1-38.2	Hardened steel	1.0D	0.05D (up to Ø1: 0.02D)	Vc	5	11	15	20	23	24	25	25	27
					fz	0.001	0.001	0.001	0.001	0.001	0.001	0.001	0.002	0.002
	40	Chilled Cast Iron	1.0D	0.05D (up to Ø1: 0.02D)	Vc	8	16	22	29	34	36	37	38	40
fz					0.001	0.001	0.001	0.001	0.002	0.002	0.003	0.003	0.003	
RPM					25465	25465	23343	23077	21645	19099	16825	15120	14147	
41	Hardened Cast Iron	1.0D	0.05D (up to Ø1: 0.02D)	Vc	5	11	15	20	23	24	25	25	27	
				fz	0.001	0.001	0.001	0.001	0.001	0.001	0.001	0.002	0.002	
				RPM	15915	17507	15915	15915	14642	12732	11368	9947	9549	

▶ NEXT PAGE

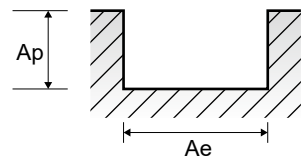

SEME35 SERIES

2 FLUTE - **SLOTING**

Vc = m/min.
fz = mm/tooth
RPM = rev./min.
FEED = mm/min.

VDI 3323	Parameter	Diameter (\varnothing)													
		1.0	1.2	1.5	2.0	2.5	3.0	3.5	4.0	4.5	5.0	5.5	6.0	6.5	7.0
1-5	Vc	68	68	71	73	80	84	91	95	98	99	102	105	107	107
	fz	0.004	0.005	0.006	0.009	0.01	0.012	0.016	0.021	0.023	0.027	0.03	0.033	0.036	0.039
	RPM	21645	18038	15067	11618	10186	8913	8276	7560	6932	6303	5903	5570	5240	4866
6-8	FEED	173	180	181	209	204	214	265	318	319	340	354	368	377	380
	Vc	68	68	71	73	80	84	91	95	98	99	102	105	107	107
	fz	0.004	0.005	0.006	0.009	0.01	0.012	0.016	0.021	0.023	0.027	0.03	0.033	0.036	0.039
9	RPM	21645	18038	15067	11618	10186	8913	8276	7560	6932	6303	5903	5570	5240	4866
	FEED	173	180	181	209	204	214	265	318	319	340	354	368	377	380
	Vc	41	41	42	48	52	52	56	58	59	59	62	63	64	65
10 - 11.1	fz	0.004	0.005	0.006	0.008	0.01	0.013	0.017	0.021	0.023	0.026	0.03	0.034	0.036	0.037
	RPM	13051	10876	8913	7639	6621	5517	5093	4615	4173	3756	3588	3342	3134	2956
	FEED	104	109	107	122	132	143	173	194	192	195	215	227	226	219
11.2	Vc	41	41	42	48	52	52	56	58	59	59	62	63	64	65
	fz	0.004	0.005	0.006	0.008	0.01	0.013	0.017	0.021	0.023	0.026	0.03	0.034	0.036	0.037
	RPM	13051	10876	8913	7639	6621	5517	5093	4615	4173	3756	3588	3342	3134	2956
14.1	FEED	104	109	107	122	132	143	173	194	192	195	215	227	226	219
	Vc	34	34	35	40	43	44	47	49	50	50	52	54	54	54
	fz	0.004	0.005	0.006	0.008	0.01	0.014	0.016	0.021	0.023	0.027	0.03	0.033	0.036	0.038
15 - 20	RPM	10823	9019	7427	6366	5475	4669	4274	3899	3537	3183	3009	2865	2644	2456
	FEED	87	90	89	102	109	131	137	164	163	172	181	189	190	187
	Vc	68	68	71	73	80	84	91	95	98	99	102	105	107	107
38.1 - 38.2	fz	0.004	0.005	0.006	0.009	0.01	0.012	0.016	0.021	0.023	0.027	0.03	0.033	0.036	0.039
	RPM	21645	18038	15067	11618	10186	8913	8276	7560	6932	6303	5903	5570	5240	4866
	FEED	173	180	181	209	204	214	265	318	319	340	354	368	377	380
40	Vc	27	27	28	32	33	32	35	37	37	36	37	38	39	40
	fz	0.002	0.002	0.003	0.004	0.005	0.006	0.007	0.007	0.009	0.011	0.013	0.015	0.016	0.018
	RPM	8594	7162	5942	5093	4202	3395	3183	2944	2617	2292	2141	2016	1910	1819
41	FEED	34	29	36	41	42	41	45	41	47	50	56	60	61	65
	Vc	41	41	42	48	52	52	56	58	59	59	62	63	64	65
	fz	0.004	0.005	0.006	0.008	0.01	0.013	0.017	0.021	0.023	0.026	0.03	0.034	0.036	0.037
41	RPM	13051	10876	8913	7639	6621	5517	5093	4615	4173	3756	3588	3342	3134	2956
	FEED	104	109	107	122	132	143	173	194	192	195	215	227	226	219
	Vc	27	27	28	32	33	32	35	37	37	36	37	38	39	40
41	fz	0.002	0.002	0.003	0.004	0.005	0.006	0.007	0.007	0.009	0.011	0.013	0.015	0.016	0.018
	RPM	8594	7162	5942	5093	4202	3395	3183	2944	2617	2292	2141	2016	1910	1819
	FEED	34	29	36	41	42	41	45	41	47	50	56	60	61	65

► NEXT PAGE

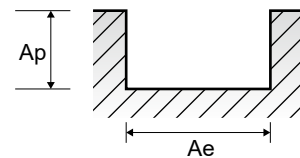

SEME35 SERIES 2 FLUTE - SLOTTING

Vc = m/min.
fz = mm/tooth
RPM = rev./min.
FEED = mm/min.

ISO	VDI 3323	Ae	Ap	Parameter	Diameter (Ø)									
					7.5	8.0	8.5	9.0	9.5	10.0	10.5	11.0	11.5	12.0
P	1-5	1.0D (up to Ø3: 0.2D) (up to Ø1: 0.15D)	0.5D	Vc	107	106	106	105	104	102	103	104	104	103
				fz	0.043	0.048	0.049	0.05	0.051	0.053	0.053	0.053	0.053	0.054
	RPM	4541	4218	3970	3714	3485	3247	3122	3009	2879	2732	2732		
	FEED	391	405	389	371	355	344	331	319	305	295	295		
	6-8	1.0D (up to Ø3: 0.2D) (up to Ø1: 0.15D)	0.5D	Vc	107	106	106	105	104	102	103	104	104	103
				fz	0.043	0.048	0.049	0.05	0.051	0.053	0.053	0.053	0.053	0.054
RPM	4541	4218	3970	3714	3485	3247	3122	3009	2879	2732	2732			
FEED	391	405	389	371	355	344	331	319	305	295	295			
9	1.0D (up to Ø3: 0.2D) (up to Ø1: 0.15D)	0.5D	Vc	64	63	64	64	64	63	63	64	64	63	
			fz	0.039	0.042	0.042	0.042	0.042	0.043	0.042	0.041	0.04	0.04	
RPM	2716	2507	2397	2264	2144	2005	1910	1852	1771	1671	1671			
FEED	212	211	201	190	180	172	160	152	142	134	134			
10 - 11.1	1.0D (up to Ø3: 0.2D) (up to Ø1: 0.15D)	0.5D	Vc	107	106	106	105	104	102	103	104	104	103	
			fz	0.043	0.048	0.049	0.05	0.051	0.053	0.053	0.053	0.053	0.054	0.054
RPM	4541	4218	3970	3714	3485	3247	3122	3009	2879	2732	2732			
FEED	391	405	389	371	355	344	331	319	305	295	295			
11.2	1.0D (up to Ø3: 0.2D) (up to Ø1: 0.15D)	0.5D	Vc	64	63	64	64	64	63	63	64	64	63	
			fz	0.039	0.042	0.042	0.042	0.042	0.043	0.042	0.041	0.04	0.04	
RPM	2716	2507	2397	2264	2144	2005	1910	1852	1771	1671	1671			
FEED	212	211	201	190	180	172	160	152	142	134	134			
M	14.1	1.0D (up to Ø1: 0.02D)	0.5D	Vc	54	53	53	53	53	53	53	53	52	51
fz	0.042	0.045	0.046	0.048	0.049	0.051	0.05	0.049	0.049	0.049	0.05			
RPM	2292	2109	1985	1874	1776	1687	1607	1534	1439	1353	1353			
FEED	193	190	183	180	174	172	161	150	141	135	135			
K	15-20	1.0D (up to Ø3: 0.2D) (up to Ø1: 0.15D)	0.5D	Vc	107	106	106	105	104	102	103	104	104	103
fz	0.043	0.048	0.049	0.05	0.051	0.053	0.053	0.053	0.053	0.054	0.054	0.054		
RPM	4541	4218	3970	3714	3485	3247	3122	3009	2879	2732	2732			
FEED	391	405	389	371	355	344	331	319	305	295	295			
H	38.1 - 38.2	1.0D (up to Ø1: 0.02D)	0.05D	Vc	41	42	43	43	43	43	43	44	44	44
				fz	0.021	0.024	0.023	0.022	0.022	0.023	0.023	0.023	0.024	0.025
	RPM	1740	1671	1610	1521	1441	1369	1304	1273	1218	1167	1167		
	FEED	73	80	74	67	63	63	60	59	58	58	58		
40	1.0D (up to Ø1: 0.02D)	0.05D	Vc	64	63	64	64	64	63	63	64	64	63	
			fz	0.039	0.042	0.042	0.042	0.042	0.043	0.042	0.041	0.04	0.04	
RPM	2716	2507	2397	2264	2144	2005	1910	1852	1771	1671	1671			
FEED	212	211	201	190	180	172	160	152	142	134	134			
41	1.0D (up to Ø1: 0.02D)	0.05D	Vc	41	42	43	43	43	43	43	44	44	44	
			fz	0.021	0.024	0.023	0.022	0.022	0.023	0.023	0.023	0.024	0.025	
RPM	1740	1671	1610	1521	1441	1369	1304	1273	1218	1167	1167			
FEED	73	80	74	67	63	63	60	59	58	58	58			

▶ NEXT PAGE

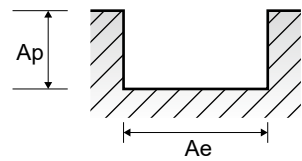

YG 4G MILL END MILLS

RECOMMENDED CUTTING CONDITIONS EMPFOHLENE SCHNEIDPARAMETER

Vc = m/min.
fz = mm/tooth
RPM = rev./min.
FEED = mm/min.

SEME35 SERIES 2 FLUTE - SLOTTING

VDI 3323	Parameter	Diameter (Ø)												
		13.0	14.0	15.0	16.0	17.0	18.0	19.0	20.0	21.0	22.0	23.0	24.0	25.0
1-5	Vc	106	109	110	111	111	110	108	106	107	107	107	107	107
	fz	0.054	0.054	0.052	0.052	0.052	0.053	0.052	0.054	0.053	0.053	0.051	0.049	0.05
	RPM	2595	2478	2334	2208	2078	1945	1809	1687	1622	1548	1481	1419	1362
6-8	FEED	280	268	243	230	216	206	188	182	172	164	151	139	136
	Vc	106	109	110	111	111	110	108	106	107	107	107	107	107
	fz	0.054	0.054	0.052	0.052	0.052	0.053	0.052	0.054	0.053	0.053	0.051	0.049	0.05
9	RPM	2595	2478	2334	2208	2078	1945	1809	1687	1622	1548	1481	1419	1362
	FEED	280	268	243	230	216	206	188	182	172	164	151	139	136
	Vc	65	67	68	68	69	68	68	67	67	67	67	67	66
10	fz	0.041	0.041	0.042	0.042	0.041	0.041	0.04	0.04	0.04	0.041	0.042	0.043	0.044
	RPM	1592	1523	1443	1353	1292	1203	1139	1066	1016	969	927	889	840
	FEED	131	125	121	114	106	99	91	85	81	79	78	76	74
11.1	Vc	106	109	110	111	111	110	108	106	107	107	107	107	107
	fz	0.054	0.054	0.052	0.052	0.052	0.053	0.052	0.054	0.053	0.053	0.051	0.049	0.05
	RPM	2595	2478	2334	2208	2078	1945	1809	1687	1622	1548	1481	1419	1362
11.2	FEED	280	268	243	230	216	206	188	182	172	164	151	139	136
	Vc	65	67	68	68	69	68	68	67	67	67	67	67	66
	fz	0.041	0.041	0.042	0.042	0.041	0.041	0.04	0.04	0.04	0.041	0.042	0.043	0.044
14.1	RPM	1592	1523	1443	1353	1292	1203	1139	1066	1016	969	927	889	840
	FEED	131	125	121	114	106	99	91	85	81	79	78	76	74
	Vc	52	53	53	53	54	54	53	53	53	54	54	54	53
15	fz	0.051	0.052	0.053	0.054	0.052	0.053	0.05	0.05	0.05	0.049	0.048	0.047	0.046
	RPM	1273	1205	1125	1054	1011	955	888	844	803	781	747	716	675
	FEED	130	125	119	114	105	101	89	84	80	77	72	67	62
20	Vc	106	109	110	111	111	110	108	106	107	107	107	107	107
	fz	0.054	0.054	0.052	0.052	0.052	0.053	0.052	0.054	0.053	0.053	0.051	0.049	0.05
	RPM	2595	2478	2334	2208	2078	1945	1809	1687	1622	1548	1481	1419	1362
38.1	FEED	280	268	243	230	216	206	188	182	172	164	151	139	136
	Vc	45	45	45	45	45	45	44	43	43	43	43	43	42
	fz	0.025	0.024	0.023	0.023	0.023	0.023	0.023	0.024	0.022	0.022	0.021	0.02	0.019
38.2	RPM	1102	1023	955	895	843	796	737	684	652	622	595	570	535
	FEED	55	49	44	41	39	37	34	33	29	27	25	23	20
	Vc	65	67	68	68	69	68	68	67	67	67	67	67	66
40	fz	0.041	0.041	0.042	0.042	0.041	0.041	0.04	0.04	0.04	0.041	0.042	0.043	0.044
	RPM	1592	1523	1443	1353	1292	1203	1139	1066	1016	969	927	889	840
	FEED	131	125	121	114	106	99	91	85	81	79	78	76	74
41	Vc	45	45	45	45	45	45	44	43	43	43	43	43	42
	fz	0.025	0.024	0.023	0.023	0.023	0.023	0.023	0.024	0.022	0.022	0.021	0.02	0.019
	RPM	1102	1023	955	895	843	796	737	684	652	622	595	570	535
41	FEED	55	49	44	41	39	37	34	33	29	27	25	23	20

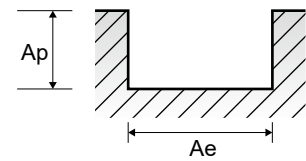

HSS

CBN END MILLS

i-Xmill END MILLS

i-SMART MODULAR END MILLS

X5070 END MILLS

4G MILL END MILLS

X-POWER PRO END MILLS

TitaNox-POWER END MILLS

JET-POWER END MILLS

V7 PLUS END MILLS

ALU-POWER HPC END MILLS

ALU-POWER END MILLS

D-POWER GRAPHITE END MILLS

D-POWER CFRP END MILLS

ROUTERS

CRX S END MILLS

K-2 END MILLS

ONLY ONE COATED PM60 END MILLS

TANK-POWER END MILLS

GENERAL HSS END MILLS

MILLING CUTTERS

TECHNICAL DATA

YG 4G MILL END MILLS

RECOMMENDED CUTTING CONDITIONS EMPFOHLENE SCHNEIDPARAMETER

SEME70 SERIES 2 FLUTE - SLOTTING

Vc = m/min. fz = mm/tooth
RPM = rev./min. FEED = mm/min.
LOC = Length of Cut

ISO	VDI 3323	Material Description	Ae	Ap	Parameter	Diameter (Ø)															
						1.0	1.0	1.0	1.0	1.0	1.0	1.0	1.0	1.2	1.2	1.2	1.2				
						LOC	3	4	5	6	7	8	10	12	4	6	8	10			
P	1-5	Non-alloy steel	1.0D	0.3D (up to Ø3:0.4mm)	Vc	50	50	50	45	45	45	45	40	51	51	46	46				
					fz	0.002	0.002	0.002	0.002	0.002	0.002	0.002	0.002	0.003	0.003	0.002	0.002				
	RPM	15915	15915	15915	14324	14324	14324	14324	12732	13528	13528	12202	12202								
	FEED	64	64	64	57	57	57	57	51	81	81	49	49								
	6-8	Low alloy steel	1.0D	0.3D (up to Ø3:0.4mm)	Vc	50	50	50	45	45	45	45	40	51	51	46	46				
fz					0.002	0.002	0.002	0.002	0.002	0.002	0.002	0.002	0.003	0.003	0.002	0.002					
9	High alloyed steel, and tool steel	1.0D	0.3D (up to Ø3:0.4mm)	Vc	40	40	40	36	36	36	36	32	41	41	37	37					
				fz	0.002	0.002	0.002	0.002	0.002	0.002	0.002	0.002	0.003	0.003	0.003	0.002					
10-11.1	High alloyed steel, and tool steel	1.0D	0.3D (up to Ø3:0.4mm)	Vc	50	50	50	45	45	45	45	40	51	51	46	46					
				fz	0.002	0.002	0.002	0.002	0.002	0.002	0.002	0.002	0.003	0.003	0.002	0.002					
11.2	High alloyed steel, and tool steel	1.0D	0.3D (up to Ø3:0.4mm)	Vc	40	40	40	36	36	36	36	32	41	41	37	37					
				fz	0.002	0.002	0.002	0.002	0.002	0.002	0.002	0.002	0.003	0.003	0.003	0.002					
K	15-20	Grey cast iron Nodular cast iron Malleable cast iron	1.0D	0.3D (up to Ø3:0.4mm)	Vc	50	50	50	45	45	45	45	40	51	51	46	46				
					fz	0.002	0.002	0.002	0.002	0.002	0.002	0.002	0.002	0.003	0.003	0.002	0.002				
H	38.1 - 38.2	Hardened steel	1.0D	0.05D	Vc	25	25	25	23	23	23	23	20	25	25	23	23				
					fz	0.002	0.002	0.002	0.002	0.002	0.001	0.001	0.001	0.002	0.002	0.002	0.002				
H	40	Chilled Cast Iron	1.0D	0.3D (up to Ø3:0.4mm)	Vc	40	40	40	36	36	36	36	32	41	41	37	37				
					fz	0.002	0.002	0.002	0.002	0.002	0.002	0.002	0.002	0.003	0.003	0.003	0.002				
H	41	Hardened Cast Iron	1.0D	0.05D	Vc	25	25	25	23	23	23	23	20	25	25	23	23				
					fz	0.002	0.002	0.002	0.002	0.002	0.001	0.001	0.001	0.002	0.002	0.002	0.002				

▶ NEXT PAGE

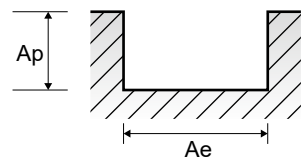

SEME70 SERIES

2 FLUTE - SLOTTING
 $V_c = \text{m/min.}$ $f_z = \text{mm/tooth}$
RPM = rev./min. FEED = mm/min.
LOC = Length of Cut

VDI 3323	Parameter	Diameter (∅)																			
		1.2	1.5	1.5	1.5	1.5	1.5	1.5	1.5	2.0	2.0	2.0	2.0	2.0	2.5	2.5	2.5	2.5	2.5	3.0	3.0
	LOC	12	6	8	10	12	14	16	8	10	12	14	16	10	12	16	20	26	10	12	14
1-5	Vc	46	53	48	48	48	48	42	57	57	51	51	51	60	60	54	54	48	60	60	60
	fz	0.002	0.004	0.003	0.003	0.003	0.003	0.003	0.005	0.005	0.004	0.004	0.004	0.006	0.006	0.005	0.005	0.004	0.008	0.008	0.008
	RPM	12202	11247	10186	10186	10186	10186	8913	9072	9072	8117	8117	8117	7639	7639	6875	6875	6112	6366	6366	6366
6-8	FEED	49	90	61	61	61	61	53	91	91	65	65	65	92	92	69	69	49	102	102	102
	Vc	46	53	48	48	48	48	42	57	57	51	51	51	60	60	54	54	48	60	60	60
	fz	0.002	0.004	0.003	0.003	0.003	0.003	0.003	0.005	0.005	0.004	0.004	0.004	0.006	0.006	0.005	0.005	0.004	0.008	0.008	0.008
9	RPM	12202	11247	10186	10186	10186	10186	8913	9072	9072	8117	8117	8117	7639	7639	6875	6875	6112	6366	6366	6366
	FEED	49	90	61	61	61	61	53	91	91	65	65	65	92	92	69	69	49	102	102	102
	Vc	37	42	38	38	38	38	34	46	46	41	41	41	49	49	44	44	39	49	49	49
10 - 11.1	fz	0.002	0.004	0.004	0.003	0.003	0.003	0.003	0.005	0.005	0.005	0.005	0.004	0.006	0.006	0.006	0.006	0.005	0.005	0.008	0.008
	RPM	9815	8913	8064	8064	8064	8064	7215	7321	7321	6525	6525	6525	6239	6239	5602	5602	4966	5199	5199	5199
	FEED	39	71	65	48	48	48	43	73	73	65	65	65	52	75	75	67	56	50	83	83
15 - 20	Vc	46	53	48	48	48	48	42	57	57	51	51	51	60	60	54	54	48	60	60	60
	fz	0.002	0.004	0.003	0.003	0.003	0.003	0.003	0.005	0.005	0.004	0.004	0.004	0.006	0.006	0.005	0.005	0.004	0.008	0.008	0.008
	RPM	12202	11247	10186	10186	10186	10186	8913	9072	9072	8117	8117	8117	7639	7639	6875	6875	6112	6366	6366	6366
38.1 - 38.2	FEED	49	90	61	61	61	61	53	91	91	65	65	65	92	92	69	69	49	102	102	102
	Vc	23	26	24	24	24	24	21	29	29	26	26	26	30	30	27	27	24	30	30	30
	fz	0.002	0.003	0.003	0.002	0.002	0.002	0.002	0.004	0.004	0.004	0.004	0.003	0.005	0.005	0.004	0.004	0.004	0.003	0.006	0.006
40	RPM	6101	5517	5093	5093	5093	5093	4456	4615	4615	4138	4138	4138	3820	3820	3438	3438	3056	3183	3183	3183
	FEED	24	33	31	20	20	20	18	37	37	33	33	25	38	38	28	28	18	38	38	38
	Vc	37	42	38	38	38	38	34	46	46	41	41	41	49	49	44	44	39	49	49	49
41	fz	0.002	0.004	0.004	0.003	0.003	0.003	0.003	0.005	0.005	0.005	0.005	0.004	0.006	0.006	0.006	0.006	0.005	0.005	0.008	0.008
	RPM	9815	8913	8064	8064	8064	8064	7215	7321	7321	6525	6525	6525	6239	6239	5602	5602	4966	5199	5199	5199
	FEED	39	71	65	48	48	48	43	73	73	65	65	65	52	75	75	67	56	50	83	83
41	Vc	23	26	24	24	24	24	21	29	29	26	26	26	30	30	27	27	24	30	30	30
	fz	0.002	0.003	0.003	0.002	0.002	0.002	0.002	0.004	0.004	0.004	0.004	0.003	0.005	0.005	0.004	0.004	0.003	0.006	0.006	0.006
	RPM	6101	5517	5093	5093	5093	5093	4456	4615	4615	4138	4138	4138	3820	3820	3438	3438	3056	3183	3183	3183
41	FEED	24	33	31	20	20	20	18	37	37	33	33	25	38	38	28	28	18	38	38	38

▶ NEXT PAGE

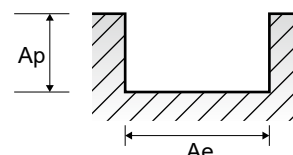

YG 4G MILL END MILLS

RECOMMENDED CUTTING CONDITIONS EMPFOHLENE SCHNEIDPARAMETER

SEME70 SERIES 2 FLUTE - SLOTTING

Vc = m/min. fz = mm/tooth
RPM = rev./min. FEED = mm/min.
LOC = Length of Cut

ISO	VDI 3323	Ae	Ap	Parameter	Diameter (Ø)															
					3.0	3.0	3.0	3.0	4.0	4.0	4.0	4.0	4.0	5.0	5.0	5.0	5.0	5.0	6.0	
					LOC	16	20	26	30	12	16	20	26	30	20	25	30	35	40	15
P	1-5	1.0D	0.3D (up to Ø3:0.4mm)	Vc	54	54	54	54	65	65	65	58	58	69	69	62	62	62	72	
				fz	0.008	0.007	0.006	0.006	0.012	0.012	0.012	0.01	0.01	0.017	0.017	0.015	0.015	0.014	0.024	
	RPM	5730	5730	5730	5730	5173	5173	5173	4615	4615	4393	4393	3947	3947	3947	3820				
	FEED	92	80	69	69	124	124	124	92	92	149	149	118	118	111	183				
	6-8	1.0D	0.3D (up to Ø3:0.4mm)	Vc	54	54	54	54	65	65	65	58	58	69	69	62	62	62	72	
fz				0.008	0.007	0.006	0.006	0.012	0.012	0.012	0.01	0.01	0.017	0.017	0.015	0.015	0.014	0.024		
RPM	5730	5730	5730	5730	5173	5173	5173	4615	4615	4393	4393	3947	3947	3947	3820					
FEED	92	80	69	69	124	124	124	92	92	149	149	118	118	111	183					
9	1.0D	0.3D (up to Ø3:0.4mm)	Vc	44	44	44	44	52	52	52	46	46	55	55	49	49	49	57		
			fz	0.008	0.008	0.006	0.006	0.012	0.012	0.012	0.012	0.012	0.018	0.018	0.016	0.016	0.014	0.025		
RPM	4669	4669	4669	4669	4138	4138	4138	3661	3661	3501	3501	3119	3119	3119	3024					
FEED	75	75	56	56	99	99	99	88	88	126	126	100	100	87	151					
10-11.1	1.0D	0.3D (up to Ø3:0.4mm)	Vc	54	54	54	54	65	65	65	58	58	69	69	62	62	62	72		
			fz	0.008	0.007	0.006	0.006	0.012	0.012	0.012	0.01	0.01	0.017	0.017	0.015	0.015	0.014	0.024		
RPM	5730	5730	5730	5730	5173	5173	5173	4615	4615	4393	4393	3947	3947	3947	3820					
FEED	92	80	69	69	124	124	124	92	92	149	149	118	118	111	183					
11.2	1.0D	0.3D (up to Ø3:0.4mm)	Vc	44	44	44	44	52	52	52	46	46	55	55	49	49	49	57		
			fz	0.008	0.008	0.006	0.006	0.012	0.012	0.012	0.012	0.012	0.018	0.018	0.016	0.016	0.014	0.025		
RPM	4669	4669	4669	4669	4138	4138	4138	3661	3661	3501	3501	3119	3119	3119	3024					
FEED	75	75	56	56	99	99	99	88	88	126	126	100	100	87	151					
K	15-20	1.0D	0.3D (up to Ø3:0.4mm)	Vc	54	54	54	54	65	65	65	58	58	69	69	62	62	62	72	
				fz	0.008	0.007	0.006	0.006	0.012	0.012	0.012	0.01	0.01	0.017	0.017	0.015	0.015	0.014	0.024	
RPM	5730	5730	5730	5730	5173	5173	5173	4615	4615	4393	4393	3947	3947	3947	3820					
FEED	92	80	69	69	124	124	124	92	92	149	149	118	118	111	183					
H	38.1 - 38.2	1.0D	0.05D	Vc	27	27	27	27	32	32	32	29	29	36	36	32	32	32	37	
				fz	0.007	0.006	0.005	0.005	0.01	0.01	0.01	0.009	0.009	0.012	0.012	0.011	0.011	0.01	0.018	
RPM	2865	2865	2865	2865	2546	2546	2546	2308	2308	2292	2292	2037	2037	2037	1963					
FEED	40	34	29	29	51	51	51	42	42	55	55	45	45	41	71					
H	40	1.0D	0.3D (up to Ø3:0.4mm)	Vc	44	44	44	44	52	52	52	46	46	55	55	49	49	49	57	
				fz	0.008	0.008	0.006	0.006	0.012	0.012	0.012	0.012	0.012	0.018	0.018	0.016	0.016	0.014	0.025	
RPM	4669	4669	4669	4669	4138	4138	4138	3661	3661	3501	3501	3119	3119	3119	3024					
FEED	75	75	56	56	99	99	99	88	88	126	126	100	100	87	151					
H	41	1.0D	0.05D	Vc	27	27	27	27	32	32	32	29	29	36	36	32	32	32	37	
				fz	0.007	0.006	0.005	0.005	0.01	0.01	0.01	0.009	0.009	0.012	0.012	0.011	0.011	0.01	0.018	
RPM	2865	2865	2865	2865	2546	2546	2546	2308	2308	2292	2292	2037	2037	2037	1963					
FEED	40	34	29	29	51	51	51	42	42	55	55	45	45	41	71					

▶ NEXT PAGE

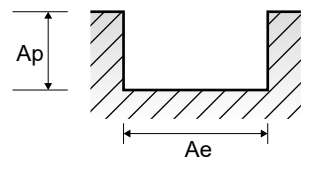



**4G MILL
END MILLS**

**RECOMMENDED CUTTING CONDITIONS
EMPFOHLENE SCHNEIDPARAMETER**

HSS

CBN
END MILLS

i-Xmill
END MILLS

i-SMART
MODULAR
END MILLS

X5070
END MILLS

**4G MILL
END MILLS**

X-POWER
PRO
END MILLS

TitaNox-
POWER
END MILLS

JET-POWER
END MILLS

V7 PLUS
END MILLS

ALU-POWER
HPC
END MILLS

ALU-
POWER
END MILLS

D-POWER
GRAPHITE
END MILLS

D-POWER
CFRP
END MILLS

ROUTERS

CRX S
END MILLS

K-2
END MILLS

ONLY ONE
COATED PM60
END MILLS

TANK-
POWER
END MILLS

GENERAL
HSS
END MILLS

MILLING
CUTTERS

TECHNICAL
DATA

SEME70 SERIES 2 FLUTE - SLOTTING

Vc = m/min. fz = mm/tooth
RPM = rev./min. FEED = mm/min.
LOC = Length of Cut

VDI 3323	Parameter	Diameter (Ø)																			
		6.0	6.0	6.0	6.0	6.0	6.0	8.0	8.0	8.0	8.0	8.0	8.0	10.0	10.0	10.0	10.0	10.0	10.0	12.0	
LOC	LOC	20	25	30	35	40	45	25	30	35	40	45	50	30	35	40	45	50	55	60	35
1-5	Vc	72	72	72	64	64	64	72	72	72	72	65	65	77	77	77	77	77	69	69	75
	fz	0.024	0.024	0.02	0.02	0.018	0.018	0.033	0.033	0.033	0.028	0.028	0.025	0.039	0.039	0.039	0.033	0.033	0.033	0.029	0.038
	RPM	3820	3820	3820	3395	3395	3395	2865	2865	2865	2865	2586	2586	2451	2451	2451	2451	2451	2196	2196	1989
6-8	FEED	183	183	153	136	122	122	189	189	189	160	145	129	191	191	191	162	162	145	127	151
	Vc	72	72	72	64	64	64	72	72	72	72	65	65	77	77	77	77	77	69	69	75
	fz	0.024	0.024	0.02	0.02	0.018	0.018	0.033	0.033	0.033	0.028	0.028	0.025	0.039	0.039	0.039	0.033	0.033	0.033	0.029	0.038
9	RPM	3820	3820	3820	3395	3395	3395	2865	2865	2865	2865	2586	2586	2451	2451	2451	2451	2451	2196	2196	1989
	FEED	183	183	153	136	122	122	189	189	189	160	145	129	191	191	191	162	162	145	127	151
	Vc	57	57	57	52	52	52	57	57	57	57	52	52	63	63	63	63	63	57	57	63
10 - 11.1	fz	0.025	0.025	0.021	0.021	0.018	0.018	0.033	0.033	0.033	0.027	0.028	0.024	0.038	0.038	0.038	0.031	0.031	0.032	0.028	0.04
	RPM	3024	3024	3024	2759	2759	2759	2268	2268	2268	2069	2069	2005	2005	2005	2005	2005	2005	1814	1814	1671
	FEED	151	151	127	116	99	99	150	150	150	122	116	99	152	152	152	124	124	116	102	134
11.2	Vc	57	57	57	52	52	52	57	57	57	57	52	52	63	63	63	63	63	57	57	63
	fz	0.025	0.025	0.021	0.021	0.018	0.018	0.033	0.033	0.033	0.027	0.028	0.024	0.038	0.038	0.038	0.031	0.031	0.032	0.028	0.04
	RPM	3024	3024	3024	2759	2759	2759	2268	2268	2268	2069	2069	2005	2005	2005	2005	2005	2005	1814	1814	1671
15 - 20	FEED	151	151	127	116	99	99	150	150	150	122	116	99	152	152	152	124	124	116	102	134
	Vc	72	72	72	64	64	64	72	72	72	72	65	65	77	77	77	77	77	69	69	75
	fz	0.024	0.024	0.02	0.02	0.018	0.018	0.033	0.033	0.033	0.028	0.028	0.025	0.039	0.039	0.039	0.033	0.033	0.033	0.029	0.038
38.1 - 38.2	RPM	3820	3820	3820	3395	3395	3395	2865	2865	2865	2865	2586	2586	2451	2451	2451	2451	2451	2196	2196	1989
	FEED	183	183	153	136	122	122	189	189	189	160	145	129	191	191	191	162	162	145	127	151
	Vc	37	37	37	33	33	33	38	38	38	38	34	34	38	38	38	38	38	34	34	38
40	fz	0.018	0.018	0.015	0.016	0.014	0.014	0.023	0.023	0.023	0.02	0.02	0.018	0.029	0.029	0.029	0.025	0.025	0.025	0.023	0.027
	RPM	1963	1963	1963	1751	1751	1751	1512	1512	1512	1512	1353	1353	1210	1210	1210	1210	1210	1082	1082	1008
	FEED	71	71	59	56	49	49	70	70	70	60	54	49	70	70	70	60	60	54	50	54
41	Vc	57	57	57	52	52	52	57	57	57	57	52	52	63	63	63	63	63	57	57	63
	fz	0.025	0.025	0.021	0.021	0.018	0.018	0.033	0.033	0.033	0.027	0.028	0.024	0.038	0.038	0.038	0.031	0.031	0.032	0.028	0.04
	RPM	3024	3024	3024	2759	2759	2759	2268	2268	2268	2069	2069	2005	2005	2005	2005	2005	2005	1814	1814	1671
41	FEED	151	151	127	116	99	99	150	150	150	122	116	99	152	152	152	124	124	116	102	134
	Vc	37	37	37	33	33	33	38	38	38	38	34	34	38	38	38	38	38	34	34	38
	fz	0.018	0.018	0.015	0.016	0.014	0.014	0.023	0.023	0.023	0.02	0.02	0.018	0.029	0.029	0.029	0.025	0.025	0.025	0.023	0.027
41	RPM	1963	1963	1963	1751	1751	1751	1512	1512	1512	1512	1353	1353	1210	1210	1210	1210	1210	1082	1082	1008
	FEED	71	71	59	56	49	49	70	70	70	60	54	49	70	70	70	60	60	54	50	54

▶ NEXT PAGE

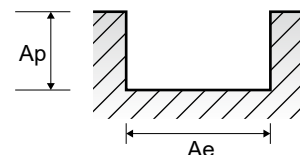

YG 4G MILL END MILLS

RECOMMENDED CUTTING CONDITIONS EMPFOHLENE SCHNEIDPARAMETER

SEME70 SERIES 2 FLUTE - SLOTTING

Vc = m/min. fz = mm/tooth
RPM = rev./min. FEED = mm/min.
LOC = Length of Cut

ISO	VDI 3323	Ae	Ap	Parameter	Diameter (Ø)																
					12.0	12.0	12.0	12.0	12.0	12.0	12.0	14.0	14.0	16.0	16.0	16.0	16.0	16.0			
					LOC	40	45	50	55	60	65	70	50	60	40	50	60	70	80		
P	1-5	1.0D	0.3D (up to Ø3:0.4mm)	Vc	75	75	75	75	75	68	68	81	81	85	85	85	85	85	85	85	
				fz	0.038	0.033	0.033	0.033	0.028	0.028	0.028	0.034	0.034	0.041	0.041	0.035	0.035	0.035	0.035	0.031	
				RPM	1989	1989	1989	1989	1989	1804	1804	1842	1842	1691	1691	1691	1691	1691	1691	1691	1691
				FEED	151	131	131	131	111	101	101	125	125	139	139	118	118	118	118	105	105
				Vc	75	75	75	75	75	68	68	81	81	85	85	85	85	85	85	85	85
K	15-20	1.0D	0.3D (up to Ø3:0.4mm)	fz	0.038	0.033	0.033	0.033	0.028	0.028	0.028	0.034	0.034	0.041	0.041	0.035	0.035	0.035	0.031		
				RPM	1989	1989	1989	1989	1989	1804	1804	1842	1842	1691	1691	1691	1691	1691	1691	1691	
				FEED	151	131	131	131	111	101	101	125	125	139	139	118	118	118	118	105	105
				Vc	63	63	63	63	63	57	57	65	65	64	64	64	64	64	64	64	64
				fz	0.04	0.034	0.034	0.034	0.03	0.03	0.03	0.034	0.034	0.041	0.041	0.035	0.035	0.035	0.035	0.031	0.031
H	38.1 - 38.2	1.0D	0.05D	RPM	1671	1671	1671	1671	1671	1512	1512	1478	1478	1273	1273	1273	1273	1273	1273		
				FEED	134	114	114	114	100	91	91	100	100	104	104	89	89	89	89	79	
				Vc	38	38	38	38	38	34	34	40	40	40	40	40	40	40	40	40	40
				fz	0.027	0.022	0.022	0.022	0.02	0.019	0.019	0.025	0.025	0.031	0.031	0.025	0.025	0.025	0.025	0.022	0.022
				RPM	1008	1008	1008	1008	1008	902	902	909	909	796	796	796	796	796	796	796	796
H	40	1.0D	0.3D (up to Ø3:0.4mm)	FEED	54	44	44	44	40	34	34	45	45	49	49	40	40	40	35		
				Vc	63	63	63	63	63	57	57	65	65	64	64	64	64	64	64	64	
				fz	0.04	0.034	0.034	0.034	0.03	0.03	0.03	0.034	0.034	0.041	0.041	0.035	0.035	0.035	0.031	0.031	
				RPM	1671	1671	1671	1671	1671	1512	1512	1478	1478	1273	1273	1273	1273	1273	1273	1273	1273
				FEED	134	114	114	114	100	91	91	100	100	104	104	89	89	89	89	79	79
H	41	1.0D	0.05D	Vc	38	38	38	38	38	34	34	40	40	40	40	40	40	40	40	40	
				fz	0.027	0.022	0.022	0.022	0.02	0.019	0.019	0.025	0.025	0.031	0.031	0.025	0.025	0.025	0.022	0.022	
				RPM	1008	1008	1008	1008	1008	902	902	909	909	796	796	796	796	796	796	796	796
				FEED	54	44	44	44	40	34	34	45	45	49	49	40	40	40	40	40	35
				Vc	38	38	38	38	38	34	34	40	40	40	40	40	40	40	40	40	40

▶ NEXT PAGE

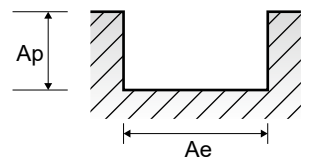

YG 4G MILL END MILLS

RECOMMENDED CUTTING CONDITIONS EMPFOHLENE SCHNEIDPARAMETER

SEME70 SERIES 2 FLUTE - SLOTTING

Vc = m/min. fz = mm/tooth
RPM = rev./min. FEED = mm/min.
LOC = Length of Cut

VDI 3323	Parameter	Diameter (Ø)																			
		16.0	16.0	16.0	18.0	18.0	18.0	20.0	20.0	20.0	20.0	20.0	20.0	20.0	20.0	22.0	22.0	25.0	25.0	25.0	25.0
	LOC	90	110	120	50	70	100	50	60	70	80	90	110	120	75	110	70	90	110	120	
1-5	Vc	77	77	77	82	82	74	77	77	77	77	77	69	69	76	76	77	77	77	77	
	fz	0.031	0.031	0.031	0.041	0.034	0.031	0.041	0.041	0.035	0.035	0.031	0.032	0.032	0.034	0.032	0.041	0.036	0.036	0.031	
	RPM	1532	1532	1532	1450	1450	1309	1225	1225	1225	1225	1225	1098	1098	1100	1100	980	980	980	980	
6-8	Vc	77	77	77	82	82	74	77	77	77	77	69	69	76	76	77	77	77	77		
	fz	0.031	0.031	0.031	0.041	0.034	0.031	0.041	0.041	0.035	0.035	0.031	0.032	0.032	0.034	0.032	0.041	0.036	0.036	0.031	
	RPM	1532	1532	1532	1450	1450	1309	1225	1225	1225	1225	1225	1098	1098	1100	1100	980	980	980	980	
9	Vc	58	58	58	63	63	57	60	60	60	60	60	54	54	58	58	59	59	59	59	
	fz	0.03	0.03	0.03	0.04	0.033	0.03	0.039	0.039	0.034	0.034	0.029	0.029	0.029	0.033	0.03	0.04	0.033	0.033	0.03	
	RPM	1154	1154	1154	1114	1114	1008	955	955	955	955	955	859	859	839	839	751	751	751	751	
10 - 11.1	Vc	77	77	77	82	82	74	77	77	77	77	69	69	76	76	77	77	77	77		
	fz	0.031	0.031	0.031	0.041	0.034	0.031	0.041	0.041	0.035	0.035	0.031	0.032	0.032	0.034	0.032	0.041	0.036	0.036	0.031	
	RPM	1532	1532	1532	1450	1450	1309	1225	1225	1225	1225	1225	1098	1098	1100	1100	980	980	980	980	
11.2	Vc	58	58	58	63	63	57	60	60	60	60	54	54	58	58	59	59	59	59		
	fz	0.03	0.03	0.03	0.04	0.033	0.03	0.039	0.039	0.034	0.034	0.029	0.029	0.033	0.03	0.04	0.033	0.033	0.03		
	RPM	1154	1154	1154	1114	1114	1008	955	955	955	955	859	859	839	839	751	751	751	751		
15 - 20	Vc	77	77	77	82	82	74	77	77	77	77	69	69	76	76	77	77	77	77		
	fz	0.031	0.031	0.031	0.041	0.034	0.031	0.041	0.041	0.035	0.035	0.031	0.032	0.032	0.034	0.032	0.041	0.036	0.036	0.031	
	RPM	1532	1532	1532	1450	1450	1309	1225	1225	1225	1225	1225	1098	1098	1100	1100	980	980	980	980	
38.1 - 38.2	Vc	36	36	36	40	40	36	38	38	38	38	34	34	38	38	38	38	38	38		
	fz	0.021	0.021	0.021	0.029	0.025	0.024	0.029	0.029	0.025	0.025	0.021	0.023	0.023	0.027	0.023	0.031	0.026	0.026	0.026	
	RPM	716	716	716	707	707	637	605	605	605	605	605	541	541	550	550	484	484	484	484	
40	Vc	58	58	58	63	63	57	60	60	60	60	54	54	58	58	59	59	59	59		
	fz	0.03	0.03	0.03	0.04	0.033	0.03	0.039	0.039	0.034	0.034	0.029	0.029	0.033	0.03	0.04	0.033	0.033	0.03		
	RPM	1154	1154	1154	1114	1114	1008	955	955	955	955	859	859	839	839	751	751	751	751		
41	Vc	36	36	36	40	40	36	38	38	38	38	34	34	38	38	38	38	38	38		
	fz	0.021	0.021	0.021	0.029	0.025	0.024	0.029	0.029	0.025	0.025	0.021	0.023	0.023	0.027	0.023	0.031	0.026	0.026	0.026	
	RPM	716	716	716	707	707	637	605	605	605	605	605	541	541	550	550	484	484	484	484	

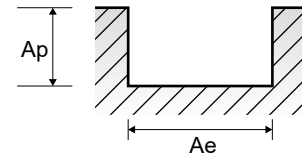

HSS

CBN
END MILLS

i-Xmill
END MILLS

i-SMART
MODULAR
END MILLS

X5070
END MILLS

4G MILL
END MILLS

X-POWER
PRO
END MILLS

TitaNox-
POWER
END MILLS

JET-POWER
END MILLS

V7 PLUS
END MILLS

ALU-POWER
HPC
END MILLS

ALU-
POWER
END MILLS

D-POWER
GRAPHITE
END MILLS

D-POWER
CFRP
END MILLS

ROUTERS

CRX S
END MILLS

K-2
END MILLS

ONLY ONE
COATED PM60
END MILLS

TANK-
POWER
END MILLS

GENERAL
HSS
END MILLS

MILLING
CUTTERS

TECHNICAL
DATA

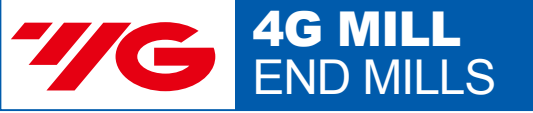

RECOMMENDED CUTTING CONDITIONS
EMPFOLHENE SCHNEIDPARAMETER

SEM845 SERIES 2 FLUTE - SLOTTING

Vc = m/min. fz = mm/tooth
RPM = rev./min. FEED = mm/min.
Ap = mm LBS = Length Below Shank

ISO	VDI 3323	Material Description	Parameter	Diameter (Ø)																
				0.1		0.15		0.2		0.2		0.3		0.3		0.3		0.4		
				LBS	0.3	0.5	1	0.35	0.5	1	1.5	2	2	3	3	3	3	3	4	5
P	1-5	Non-alloy steel	Vc	16	16	14	20	24	24	22	22	32	32	29	29	29	26	19	34	34
			fz	0.003	0.003	0.003	0.004	0.005	0.005	0.004	0.004	0.006	0.006	0.005	0.005	0.005	0.005	0.004	0.01	0.01
			RPM	50930	50930	44563	42441	38197	38197	35014	35014	33953	33953	30770	30770	30770	27587	20160	27056	27056
			FEED	306	306	267	340	382	382	280	280	407	407	308	308	308	276	161	541	541
	6-8	Low alloy steel	Vc	16	16	14	20	24	24	22	22	32	32	29	29	29	26	19	34	34
			fz	0.003	0.003	0.003	0.004	0.005	0.005	0.004	0.004	0.006	0.006	0.005	0.005	0.005	0.005	0.004	0.01	0.01
			RPM	50930	50930	44563	42441	38197	38197	35014	35014	33953	33953	30770	30770	30770	27587	20160	27056	27056
			FEED	306	306	267	340	382	382	280	280	407	407	308	308	308	276	161	541	541
	9	High alloyed steel, and tool steel	Vc	15	15	13	19	23	23	21	21	30	30	27	27	27	24	18	32	32
			fz	0.002	0.002	0.002	0.003	0.004	0.004	0.003	0.003	0.004	0.004	0.004	0.004	0.004	0.003	0.003	0.007	0.007
			RPM	47746	47746	41380	40319	36606	36606	33423	33423	31831	31831	28648	28648	28648	25465	19099	25465	25465
			FEED	191	191	166	242	293	293	201	201	255	255	229	229	229	153	115	357	357
10-11.1	High alloyed steel, and tool steel	Vc	16	16	14	20	24	24	22	22	32	32	29	29	29	26	19	34	34	
		fz	0.003	0.003	0.003	0.004	0.005	0.005	0.004	0.004	0.006	0.006	0.005	0.005	0.005	0.005	0.004	0.01	0.01	
		RPM	50930	50930	44563	42441	38197	38197	35014	35014	33953	33953	30770	30770	30770	27587	20160	27056	27056	
		FEED	306	306	267	340	382	382	280	280	407	407	308	308	308	276	161	541	541	
11.2	High alloyed steel, and tool steel	Vc	15	15	13	19	23	23	21	21	30	30	27	27	27	24	18	32	32	
		fz	0.002	0.002	0.002	0.003	0.004	0.004	0.003	0.003	0.004	0.004	0.004	0.004	0.004	0.003	0.003	0.007	0.007	
		RPM	47746	47746	41380	40319	36606	36606	33423	33423	31831	31831	28648	28648	28648	25465	19099	25465	25465	
		FEED	191	191	166	242	293	293	201	201	255	255	229	229	229	153	115	357	357	
K	15-20	Grey cast iron Nodular cast iron Malleable cast iron	Vc	16	16	14	20	24	24	22	22	32	32	29	29	29	26	19	34	34
			fz	0.003	0.003	0.003	0.004	0.005	0.005	0.004	0.004	0.006	0.006	0.005	0.005	0.005	0.005	0.004	0.01	0.01
			RPM	50930	50930	44563	42441	38197	38197	35014	35014	33953	33953	30770	30770	30770	27587	20160	27056	27056
			FEED	306	306	267	340	382	382	280	280	407	407	308	308	308	276	161	541	541
H	38.1 - 38.2	Hardened steel	Vc	13	13	11	16	20	20	18	18	27	27	24	24	24	21	16	29	29
			fz	0.002	0.002	0.002	0.002	0.003	0.003	0.003	0.003	0.004	0.004	0.004	0.004	0.004	0.003	0.003	0.006	0.006
			RPM	41380	41380	35014	33953	31831	31831	28648	28648	28648	28648	25465	25465	25465	22282	16977	23077	23077
			FEED	166	166	140	136	191	191	172	172	229	229	204	204	204	134	102	277	277
	40	Chilled Cast Iron	Vc	15	15	13	19	23	23	21	21	30	30	27	27	27	24	18	32	32
			fz	0.002	0.002	0.002	0.003	0.004	0.004	0.003	0.003	0.004	0.004	0.004	0.004	0.004	0.003	0.003	0.007	0.007
			RPM	47746	47746	41380	40319	36606	36606	33423	33423	31831	31831	28648	28648	28648	25465	19099	25465	25465
			FEED	191	191	166	242	293	293	201	201	255	255	229	229	229	153	115	357	357
	41	Hardened Cast Iron	Vc	13	13	11	16	20	20	18	18	27	27	24	24	24	21	16	29	29
			fz	0.002	0.002	0.002	0.002	0.003	0.003	0.003	0.003	0.004	0.004	0.004	0.004	0.004	0.003	0.003	0.006	0.006
			RPM	41380	41380	35014	33953	31831	31831	28648	28648	28648	28648	25465	25465	25465	22282	16977	23077	23077
			FEED	166	166	140	136	191	191	172	172	229	229	204	204	204	134	102	277	277

▶ NEXT PAGE

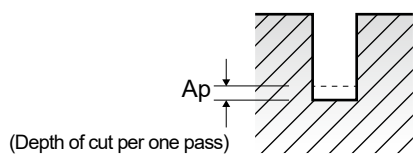

YG 4G MILL END MILLS

RECOMMENDED CUTTING CONDITIONS EMPFOLHENE SCHNEIDPARAMETER

SEM845 SERIES 2 FLUTE - SLOTTING

Vc = m/min. fz = mm/tooth
RPM = rev./min. FEED = mm/min.
Ap = mm LBS = Length Below Shank

ISO	VDI 3323	Parameter	Diameter (Ø)																			
			0.6		0.6		0.6		0.6		0.6		0.7		0.7		0.7		0.8			
			LBS	4	5	6	8	10	12	14	16	2	4	6	8	10	12	2	3	4	5	6
P	1-5	Vc	46	46	46	41	31	31	15	15	60	54	54	48	48	36	69	69	69	62	62	
		fz	0.013	0.013	0.013	0.011	0.01	0.01	0.009	0.009	0.014	0.013	0.013	0.011	0.011	0.01	0.014	0.014	0.014	0.013	0.013	
		RPM	24404	24404	24404	21751	16446	16446	7958	7958	27284	24555	24555	21827	21827	16370	27454	27454	27454	24669	24669	
		FEED	634	634	634	479	329	329	143	143	764	638	638	480	480	327	769	769	769	641	641	
	6-8	Vc	46	46	46	41	31	31	15	15	60	54	54	48	48	36	69	69	69	62	62	
		fz	0.013	0.013	0.013	0.011	0.01	0.01	0.009	0.009	0.014	0.013	0.013	0.011	0.011	0.01	0.014	0.014	0.014	0.013	0.013	
		RPM	24404	24404	24404	21751	16446	16446	7958	7958	27284	24555	24555	21827	21827	16370	27454	27454	27454	24669	24669	
		FEED	634	634	634	479	329	329	143	143	764	638	638	480	480	327	769	769	769	641	641	
	9	Vc	44	44	44	39	29	29	15	15	57	51	51	45	45	34	65	65	65	58	58	
		fz	0.009	0.009	0.009	0.008	0.007	0.007	0.006	0.006	0.011	0.009	0.009	0.008	0.008	0.007	0.012	0.012	0.012	0.011	0.011	
		RPM	23343	23343	23343	20690	15385	15385	7958	7958	25920	23191	23191	20463	20463	15461	25863	25863	25863	23077	23077	
		FEED	420	420	420	331	215	215	95	95	570	417	417	327	327	216	621	621	621	508	508	
	10-11.1	Vc	46	46	46	41	31	31	15	15	60	54	54	48	48	36	69	69	69	62	62	
		fz	0.013	0.013	0.013	0.011	0.01	0.01	0.009	0.009	0.014	0.013	0.013	0.011	0.011	0.01	0.014	0.014	0.014	0.013	0.013	
		RPM	24404	24404	24404	21751	16446	16446	7958	7958	27284	24555	24555	21827	21827	16370	27454	27454	27454	24669	24669	
		FEED	634	634	634	479	329	329	143	143	764	638	638	480	480	327	769	769	769	641	641	
	11.2	Vc	44	44	44	39	29	29	15	15	57	51	51	45	45	34	65	65	65	58	58	
		fz	0.009	0.009	0.009	0.008	0.007	0.007	0.006	0.006	0.011	0.009	0.009	0.008	0.008	0.007	0.012	0.012	0.012	0.011	0.011	
		RPM	23343	23343	23343	20690	15385	15385	7958	7958	25920	23191	23191	20463	20463	15461	25863	25863	25863	23077	23077	
		FEED	420	420	420	331	215	215	95	95	570	417	417	327	327	216	621	621	621	508	508	
	K	15-20	Vc	46	46	46	41	31	31	15	15	60	54	54	48	48	36	69	69	69	62	62
			fz	0.013	0.013	0.013	0.011	0.01	0.01	0.009	0.009	0.014	0.013	0.013	0.011	0.011	0.01	0.014	0.014	0.014	0.013	0.013
			RPM	24404	24404	24404	21751	16446	16446	7958	7958	27284	24555	24555	21827	21827	16370	27454	27454	27454	24669	24669
			FEED	634	634	634	479	329	329	143	143	764	638	638	480	480	327	769	769	769	641	641
H	38.1 - 38.2	Vc	39	39	39	34	26	26	13	13	50	45	45	40	40	30	57	57	57	52	52	
		fz	0.008	0.008	0.008	0.007	0.006	0.006	0.005	0.005	0.009	0.008	0.008	0.007	0.007	0.006	0.01	0.01	0.01	0.009	0.009	
		RPM	20690	20690	20690	18038	13793	13793	6897	6897	22736	20463	20463	18189	18189	13642	22680	22680	22680	20690	20690	
		FEED	331	331	331	253	166	166	69	69	409	327	327	255	255	164	454	454	454	372	372	
	40	Vc	44	44	44	39	29	29	15	15	57	51	51	45	45	34	65	65	65	58	58	
		fz	0.009	0.009	0.009	0.008	0.007	0.007	0.006	0.006	0.011	0.009	0.009	0.008	0.008	0.007	0.012	0.012	0.012	0.011	0.011	
		RPM	23343	23343	23343	20690	15385	15385	7958	7958	25920	23191	23191	20463	20463	15461	25863	25863	25863	23077	23077	
		FEED	420	420	420	331	215	215	95	95	570	417	417	327	327	216	621	621	621	508	508	
	41	Vc	39	39	39	34	26	26	13	13	50	45	45	40	40	30	57	57	57	52	52	
		fz	0.008	0.008	0.008	0.007	0.006	0.006	0.005	0.005	0.009	0.008	0.008	0.007	0.007	0.006	0.01	0.01	0.01	0.009	0.009	
		RPM	20690	20690	20690	18038	13793	13793	6897	6897	22736	20463	20463	18189	18189	13642	22680	22680	22680	20690	20690	
		FEED	331	331	331	253	166	166	69	69	409	327	327	255	255	164	454	454	454	372	372	

▶ NEXT PAGE

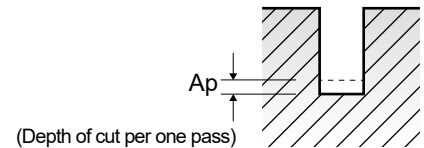

YG 4G MILL END MILLS

RECOMMENDED CUTTING CONDITIONS EMPFOHLENE SCHNEIDPARAMETER

SEM845 SERIES 2 FLUTE - SLOTTING

Vc = m/min. fz = mm/tooth
RPM = rev./min. FEED = mm/min.
Ap = mm LBS = Length Below Shank

ISO	VDI 3323	Parameter	Diameter (Ø)																			
			1.0	1.0	1.0	1.0	1.2	1.2	1.2	1.2	1.2	1.2	1.2	1.2	1.2	1.2	1.4	1.4	1.4	1.4	1.4	
			LBS	26	30	40	50	4	6	8	10	12	14	16	20	26	30	6	8	10	14	16
P	1-5	Vc	23	23	8	8	83	83	74	74	74	66	66	50	25	25	84	76	76	76	68	
		fz	0.013	0.013	0.01	0.01	0.021	0.021	0.019	0.019	0.019	0.017	0.017	0.015	0.013	0.013	0.021	0.019	0.019	0.019	0.017	
		RPM	7321	7321	2546	2546	22016	22016	19629	19629	19629	17507	17507	13263	6631	6631	19099	17280	17280	17280	15461	
		FEED	190	190	51	51	925	925	746	746	746	595	595	398	172	172	802	657	657	657	526	
	6-8	Vc	23	23	8	8	83	83	74	74	74	66	66	50	25	25	84	76	76	76	68	
		fz	0.013	0.013	0.01	0.01	0.021	0.021	0.019	0.019	0.019	0.017	0.017	0.015	0.013	0.013	0.021	0.019	0.019	0.019	0.017	
		RPM	7321	7321	2546	2546	22016	22016	19629	19629	19629	17507	17507	13263	6631	6631	19099	17280	17280	17280	15461	
		FEED	190	190	51	51	925	925	746	746	746	595	595	398	172	172	802	657	657	657	526	
	9	Vc	22	22	7	7	78	78	70	70	70	62	62	47	23	23	80	72	72	72	64	
		fz	0.011	0.011	0.01	0.01	0.017	0.017	0.016	0.016	0.016	0.014	0.014	0.012	0.01	0.01	0.016	0.014	0.014	0.014	0.013	
		RPM	7003	7003	2228	2228	20690	20690	18568	18568	18568	16446	16446	12467	6101	6101	18189	16370	16370	16370	14551	
		FEED	154	154	45	45	703	703	594	594	594	460	460	299	122	122	582	458	458	458	378	
	10-11.1	Vc	23	23	8	8	83	83	74	74	74	66	66	50	25	25	84	76	76	76	68	
		fz	0.013	0.013	0.01	0.01	0.021	0.021	0.019	0.019	0.019	0.017	0.017	0.015	0.013	0.013	0.021	0.019	0.019	0.019	0.017	
		RPM	7321	7321	2546	2546	22016	22016	19629	19629	19629	17507	17507	13263	6631	6631	19099	17280	17280	17280	15461	
		FEED	190	190	51	51	925	925	746	746	746	595	595	398	172	172	802	657	657	657	526	
	11.2	Vc	22	22	7	7	78	78	70	70	70	62	62	47	23	23	80	72	72	72	64	
		fz	0.011	0.011	0.01	0.01	0.017	0.017	0.016	0.016	0.016	0.014	0.014	0.012	0.01	0.01	0.016	0.014	0.014	0.014	0.013	
		RPM	7003	7003	2228	2228	20690	20690	18568	18568	18568	16446	16446	12467	6101	6101	18189	16370	16370	16370	14551	
		FEED	154	154	45	45	703	703	594	594	594	460	460	299	122	122	582	458	458	458	378	
	K	15-20	Vc	23	23	8	8	83	83	74	74	74	66	66	50	25	25	84	76	76	76	68
			fz	0.013	0.013	0.01	0.01	0.021	0.021	0.019	0.019	0.019	0.017	0.017	0.015	0.013	0.013	0.021	0.019	0.019	0.019	0.017
			RPM	7321	7321	2546	2546	22016	22016	19629	19629	19629	17507	17507	13263	6631	6631	19099	17280	17280	17280	15461
			FEED	190	190	51	51	925	925	746	746	746	595	595	398	172	172	802	657	657	657	526
H	38.1 - 38.2	Vc	19	19	6	6	69	69	62	62	62	55	55	41	21	21	70	63	63	63	56	
		fz	0.01	0.01	0.009	0.009	0.013	0.013	0.012	0.012	0.012	0.011	0.011	0.009	0.008	0.008	0.013	0.012	0.012	0.012	0.011	
		RPM	6048	6048	1910	1910	18303	18303	16446	16446	16446	14589	14589	10876	5570	5570	15915	14324	14324	14324	12732	
		FEED	121	121	34	34	476	476	395	395	395	321	321	196	89	89	414	344	344	344	280	
	40	Vc	22	22	7	7	78	78	70	70	70	62	62	47	23	23	80	72	72	72	64	
		fz	0.011	0.011	0.01	0.01	0.017	0.017	0.016	0.016	0.016	0.014	0.014	0.012	0.01	0.01	0.016	0.014	0.014	0.014	0.013	
		RPM	7003	7003	2228	2228	20690	20690	18568	18568	18568	16446	16446	12467	6101	6101	18189	16370	16370	16370	14551	
		FEED	154	154	45	45	703	703	594	594	594	460	460	299	122	122	582	458	458	458	378	
	41	Vc	19	19	6	6	69	69	62	62	62	55	55	41	21	21	70	63	63	63	56	
		fz	0.01	0.01	0.009	0.009	0.013	0.013	0.012	0.012	0.012	0.011	0.011	0.009	0.008	0.008	0.013	0.012	0.012	0.012	0.011	
		RPM	6048	6048	1910	1910	18303	18303	16446	16446	16446	14589	14589	10876	5570	5570	15915	14324	14324	14324	12732	
		FEED	121	121	34	34	476	476	395	395	395	321	321	196	89	89	414	344	344	344	280	

▶ NEXT PAGE

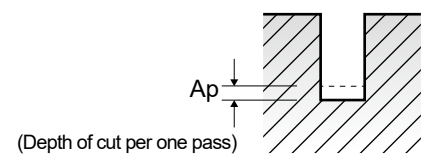

SEM845 SERIES 2 FLUTE - SLOTTING

Vc = m/min. fz = mm/tooth
RPM = rev./min. FEED = mm/min.
Ap = mm LBS = Length Below Shank

ISO	VDI 3323	Parameter	Diameter (Ø)																			
			1.8	1.8	2.0	2.0	2.0	2.0	2.0	2.0	2.0	2.0	2.0	2.0	2.0	2.0	2.0	2.5				
			LBS	16	20	6	8	10	12	14	16	18	20	22	26	30	35	40	45	50	60	8
P	1-5	Vc	91	81	90	90	90	81	81	81	81	81	72	72	72	54	54	27	27	27	97	
		fz	0.021	0.019	0.028	0.028	0.028	0.026	0.026	0.026	0.026	0.026	0.023	0.023	0.023	0.02	0.02	0.017	0.017	0.017	0.039	
		RPM	16092	14324	14324	14324	14324	12892	12892	12892	12892	12892	11459	11459	11459	8594	8594	4297	4297	4297	12350	
		FEED	676	544	802	802	802	670	670	670	670	670	527	527	527	344	344	146	146	146	963	
	6-8	Vc	91	81	90	90	90	81	81	81	81	81	72	72	72	54	54	27	27	27	97	
		fz	0.021	0.019	0.028	0.028	0.028	0.026	0.026	0.026	0.026	0.023	0.023	0.023	0.023	0.02	0.02	0.017	0.017	0.017	0.039	
		RPM	16092	14324	14324	14324	14324	12892	12892	12892	12892	12892	11459	11459	11459	8594	8594	4297	4297	4297	12350	
		FEED	676	544	802	802	802	670	670	670	670	670	527	527	527	344	344	146	146	146	963	
	9	Vc	86	76	85	85	85	77	77	77	77	77	68	68	68	51	51	26	26	26	91	
		fz	0.018	0.016	0.023	0.023	0.023	0.02	0.02	0.02	0.02	0.02	0.018	0.018	0.018	0.016	0.016	0.013	0.013	0.013	0.029	
		RPM	15208	13440	13528	13528	13528	12255	12255	12255	12255	12255	10823	10823	10823	8117	8117	4138	4138	4138	11586	
		FEED	547	430	622	622	622	490	490	490	490	490	390	390	390	260	260	108	108	108	672	
	10-11.1	Vc	91	81	90	90	90	81	81	81	81	81	72	72	72	54	54	27	27	27	97	
		fz	0.021	0.019	0.028	0.028	0.028	0.026	0.026	0.026	0.026	0.026	0.023	0.023	0.023	0.02	0.02	0.017	0.017	0.017	0.039	
		RPM	16092	14324	14324	14324	14324	12892	12892	12892	12892	12892	11459	11459	11459	8594	8594	4297	4297	4297	12350	
		FEED	676	544	802	802	802	670	670	670	670	670	527	527	527	344	344	146	146	146	963	
	11.2	Vc	86	76	85	85	85	77	77	77	77	77	68	68	68	51	51	26	26	26	91	
		fz	0.018	0.016	0.023	0.023	0.023	0.02	0.02	0.02	0.02	0.02	0.018	0.018	0.018	0.016	0.016	0.013	0.013	0.013	0.029	
		RPM	15208	13440	13528	13528	13528	12255	12255	12255	12255	12255	10823	10823	10823	8117	8117	4138	4138	4138	11586	
		FEED	547	430	622	622	622	490	490	490	490	490	390	390	390	260	260	108	108	108	672	
	K	15-20	Vc	91	81	90	90	90	81	81	81	81	81	72	72	72	54	54	27	27	27	97
			fz	0.021	0.019	0.028	0.028	0.028	0.026	0.026	0.026	0.026	0.026	0.023	0.023	0.023	0.02	0.02	0.017	0.017	0.017	0.039
			RPM	16092	14324	14324	14324	14324	12892	12892	12892	12892	12892	11459	11459	11459	8594	8594	4297	4297	4297	12350
			FEED	676	544	802	802	802	670	670	670	670	670	527	527	527	344	344	146	146	146	963
H	38.1 - 38.2	Vc	75	67	75	75	75	68	68	68	68	68	60	60	60	45	45	23	23	23	81	
		fz	0.015	0.013	0.02	0.02	0.02	0.018	0.018	0.018	0.018	0.018	0.016	0.016	0.016	0.014	0.014	0.012	0.012	0.012	0.025	
		RPM	13263	11848	11937	11937	11937	10823	10823	10823	10823	10823	9549	9549	9549	7162	7162	3661	3661	3661	10313	
		FEED	398	308	477	477	477	390	390	390	390	390	306	306	306	201	201	88	88	88	516	
	40	Vc	86	76	85	85	85	77	77	77	77	77	68	68	68	51	51	26	26	26	91	
		fz	0.018	0.016	0.023	0.023	0.023	0.02	0.02	0.02	0.02	0.02	0.018	0.018	0.018	0.016	0.016	0.013	0.013	0.013	0.029	
		RPM	15208	13440	13528	13528	13528	12255	12255	12255	12255	12255	10823	10823	10823	8117	8117	4138	4138	4138	11586	
		FEED	547	430	622	622	622	490	490	490	490	490	390	390	390	260	260	108	108	108	672	
	41	Vc	75	67	75	75	75	68	68	68	68	68	60	60	60	45	45	23	23	23	81	
		fz	0.015	0.013	0.02	0.02	0.02	0.018	0.018	0.018	0.018	0.018	0.016	0.016	0.016	0.014	0.014	0.012	0.012	0.012	0.025	
		RPM	13263	11848	11937	11937	11937	10823	10823	10823	10823	10823	9549	9549	9549	7162	7162	3661	3661	3661	10313	
		FEED	398	308	477	477	477	390	390	390	390	390	306	306	306	201	201	88	88	88	516	

▶ NEXT PAGE

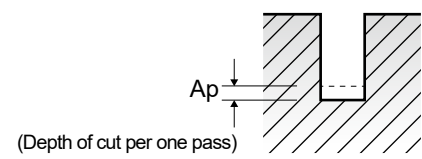

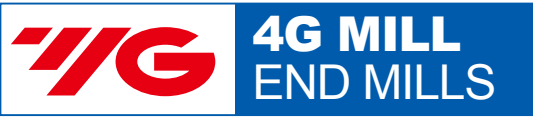

RECOMMENDED CUTTING CONDITIONS
EMPFOHLENE SCHNEIDPARAMETER

SEM845 SERIES 2 FLUTE - SLOTTING

Vc = m/min. fz = mm/tooth
RPM = rev./min. FEED = mm/min.
Ap = mm LBS = Length Below Shank

ISO	VDI 3323	Parameter	Diameter (Ø)																				
			3.0		3.0		3.0		3.0		3.0		4.0		4.0		4.0		4.0				
			LBS	30	35	40	45	50	60	8	10	12	14	16	18	20	22	26	30	35	40	45	
P	1-5	Vc	92	82	82	82	62	62	101	101	101	101	101	101	101	101	90	90	90	90	90	80	
		fz	0.035	0.032	0.032	0.032	0.028	0.028	0.081	0.081	0.081	0.081	0.081	0.081	0.081	0.073	0.073	0.073	0.073	0.073	0.065		
		RPM	9762	8700	8700	8700	6578	6578	8037	8037	8037	8037	8037	8037	8037	8037	7162	7162	7162	7162	7162	6366	
		FEED	683	557	557	557	368	368	1302	1302	1302	1302	1302	1302	1302	1302	1046	1046	1046	1046	1046	828	
	6-8	Vc	92	82	82	82	62	62	101	101	101	101	101	101	101	101	90	90	90	90	90	80	
		fz	0.035	0.032	0.032	0.032	0.028	0.028	0.081	0.081	0.081	0.081	0.081	0.081	0.081	0.073	0.073	0.073	0.073	0.073	0.065		
		RPM	9762	8700	8700	8700	6578	6578	8037	8037	8037	8037	8037	8037	8037	8037	7162	7162	7162	7162	7162	6366	
		FEED	683	557	557	557	368	368	1302	1302	1302	1302	1302	1302	1302	1302	1046	1046	1046	1046	1046	828	
	9	Vc	87	78	78	78	58	58	96	96	96	96	96	96	96	96	86	86	86	86	86	76	
		fz	0.026	0.023	0.023	0.023	0.021	0.021	0.076	0.076	0.076	0.076	0.076	0.076	0.076	0.069	0.069	0.069	0.069	0.069	0.061		
		RPM	9231	8276	8276	8276	6154	6154	7639	7639	7639	7639	7639	7639	7639	7639	6844	6844	6844	6844	6844	6048	
		FEED	480	381	381	381	258	258	1161	1161	1161	1161	1161	1161	1161	1161	944	944	944	944	944	738	
	10-11.1	Vc	92	82	82	82	62	62	101	101	101	101	101	101	101	101	90	90	90	90	90	80	
		fz	0.035	0.032	0.032	0.032	0.028	0.028	0.081	0.081	0.081	0.081	0.081	0.081	0.081	0.073	0.073	0.073	0.073	0.073	0.065		
		RPM	9762	8700	8700	8700	6578	6578	8037	8037	8037	8037	8037	8037	8037	8037	7162	7162	7162	7162	7162	6366	
		FEED	683	557	557	557	368	368	1302	1302	1302	1302	1302	1302	1302	1302	1046	1046	1046	1046	1046	828	
	11.2	Vc	87	78	78	78	58	58	96	96	96	96	96	96	96	96	86	86	86	86	86	76	
		fz	0.026	0.023	0.023	0.023	0.021	0.021	0.076	0.076	0.076	0.076	0.076	0.076	0.076	0.069	0.069	0.069	0.069	0.069	0.061		
		RPM	9231	8276	8276	8276	6154	6154	7639	7639	7639	7639	7639	7639	7639	7639	6844	6844	6844	6844	6844	6048	
		FEED	480	381	381	381	258	258	1161	1161	1161	1161	1161	1161	1161	1161	944	944	944	944	944	738	
	K	15-20	Vc	92	82	82	82	62	62	101	101	101	101	101	101	101	90	90	90	90	90	80	
			fz	0.035	0.032	0.032	0.032	0.028	0.028	0.081	0.081	0.081	0.081	0.081	0.081	0.081	0.073	0.073	0.073	0.073	0.073	0.065	
			RPM	9762	8700	8700	8700	6578	6578	8037	8037	8037	8037	8037	8037	8037	8037	7162	7162	7162	7162	7162	6366
			FEED	683	557	557	557	368	368	1302	1302	1302	1302	1302	1302	1302	1302	1046	1046	1046	1046	1046	828
H	38.1 - 38.2	Vc	56	50	50	50	37	37	84	84	84	84	84	84	84	76	76	76	76	76	67		
		fz	0.031	0.027	0.027	0.027	0.024	0.024	0.057	0.057	0.057	0.057	0.057	0.057	0.057	0.052	0.052	0.052	0.052	0.052	0.046		
		RPM	5942	5305	5305	5305	3926	3926	6685	6685	6685	6685	6685	6685	6685	6685	6048	6048	6048	6048	6048	5332	
		FEED	368	286	286	286	188	188	762	762	762	762	762	762	762	762	629	629	629	629	629	491	
	40	Vc	87	78	78	78	58	58	96	96	96	96	96	96	96	96	86	86	86	86	86	76	
		fz	0.026	0.023	0.023	0.023	0.021	0.021	0.076	0.076	0.076	0.076	0.076	0.076	0.076	0.069	0.069	0.069	0.069	0.069	0.061		
		RPM	9231	8276	8276	8276	6154	6154	7639	7639	7639	7639	7639	7639	7639	7639	6844	6844	6844	6844	6844	6048	
		FEED	480	381	381	381	258	258	1161	1161	1161	1161	1161	1161	1161	1161	944	944	944	944	944	738	
	41	Vc	56	50	50	50	37	37	84	84	84	84	84	84	84	84	76	76	76	76	76	67	
		fz	0.031	0.027	0.027	0.027	0.024	0.024	0.057	0.057	0.057	0.057	0.057	0.057	0.057	0.052	0.052	0.052	0.052	0.052	0.046		
		RPM	5942	5305	5305	5305	3926	3926	6685	6685	6685	6685	6685	6685	6685	6685	6048	6048	6048	6048	6048	5332	
		FEED	368	286	286	286	188	188	762	762	762	762	762	762	762	762	629	629	629	629	629	491	

▶ NEXT PAGE

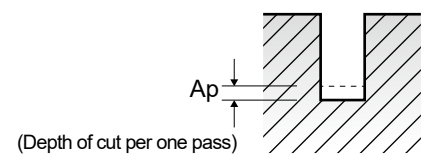

SEME36, SEME71 SERIES 4 FLUTE - SIDE CUTTING

Vc = m/min.
fz = mm/tooth
RPM = rev./min.
FEED = mm/min.

ISO	VDI 3323	Material Description	Ae	Ap	Parameter	Diameter (Ø)							
						0.8	0.9	1.0	1.2	1.5	2.0	2.5	3.0
P	1-5	Non-alloy steel	0.05D	1.0D	Vc	79	83	84	85	88	91	101	105
					fz	0.002	0.002	0.002	0.003	0.004	0.005	0.006	0.008
					RPM	31433	29355	26738	22547	18674	14483	12860	11141
	6-8	Low alloy steel	0.05D	1.0D	Vc	79	83	84	85	88	91	101	105
					fz	0.002	0.002	0.002	0.003	0.004	0.005	0.006	0.008
					RPM	31433	29355	26738	22547	18674	14483	12860	11141
	9	Low alloy steel	0.05D	1.0D	Vc	47	50	51	51	53	59	64	66
					fz	0.002	0.002	0.002	0.003	0.004	0.005	0.006	0.008
					RPM	18701	17684	16234	13528	11247	9390	8149	7003
	10-11.1	High alloyed steel, and tool steel	0.05D	1.0D	Vc	79	83	84	85	88	91	101	105
					fz	0.002	0.002	0.002	0.003	0.004	0.005	0.006	0.008
					RPM	31433	29355	26738	22547	18674	14483	12860	11141
11.2	High alloyed steel, and tool steel	0.05D	1.0D	Vc	47	50	51	51	53	59	64	66	
				fz	0.002	0.002	0.002	0.003	0.004	0.005	0.006	0.008	
				RPM	18701	17684	16234	13528	11247	9390	8149	7003	
M	14.1	Stainless steel	0.05D	1.0D	Vc	39	41	42	42	44	50	54	54
					fz	0.002	0.002	0.002	0.003	0.004	0.005	0.006	0.008
					RPM	15518	14501	13369	11141	9337	7958	6875	5730
K	15-20	Grey cast iron Nodular cast iron Malleable cast iron	0.05D	1.0D	Vc	79	83	84	85	88	91	101	105
					fz	0.002	0.002	0.002	0.003	0.004	0.005	0.006	0.008
					RPM	31433	29355	26738	22547	18674	14483	12860	11141
H	38.1 - 38.2	Hardened steel	0.05D	1.0D	Vc	31	33	34	34	35	40	41	40
					fz	0.001	0.001	0.001	0.001	0.002	0.002	0.003	0.004
					RPM	12335	11671	10823	9019	7427	6366	5220	4244
H	40	Chilled Cast Iron	0.05D	1.0D	Vc	47	50	51	51	53	59	64	66
					fz	0.002	0.002	0.002	0.003	0.004	0.005	0.006	0.008
					RPM	18701	17684	16234	13528	11247	9390	8149	7003
H	41	Hardened Cast Iron	0.05D	1.0D	Vc	31	33	34	34	35	40	41	40
					fz	0.001	0.001	0.001	0.001	0.002	0.002	0.003	0.004
					RPM	12335	11671	10823	9019	7427	6366	5220	4244

▶ NEXT PAGE

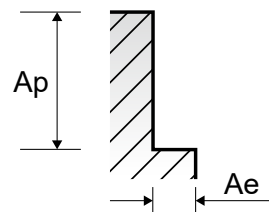

YG 4G MILL END MILLS

RECOMMENDED CUTTING CONDITIONS EMPFOHLENE SCHNEIDPARAMETER

SEME36, SEME71 SERIES 4 FLUTE - SIDE CUTTING

Vc = m/min.
fz = mm/tooth
RPM = rev./min.
FEED = mm/min.

VDI 3323	Parameter	Diameter (Ø)											
		3.5	4.0	4.5	5.0	5.5	6.0	6.5	7.0	7.5	8.0	8.5	9.0
1-5	Vc	113	119	122	124	128	131	133	134	134	132	132	132
	fz	0.011	0.016	0.018	0.02	0.022	0.025	0.027	0.03	0.032	0.035	0.036	0.037
	RPM	10277	9470	8630	7894	7408	6950	6513	6093	5687	5252	4943	4669
6-8	FEED	452	606	621	632	652	695	703	731	728	735	712	691
	Vc	113	119	122	124	128	131	133	134	134	132	132	132
	fz	0.011	0.016	0.018	0.02	0.022	0.025	0.027	0.03	0.032	0.035	0.036	0.037
9	RPM	10277	9470	8630	7894	7408	6950	6513	6093	5687	5252	4943	4669
	FEED	452	606	621	632	652	695	703	731	728	735	712	691
	Vc	70	73	74	74	77	79	80	81	80	79	80	80
10	fz	0.011	0.016	0.018	0.02	0.023	0.026	0.027	0.028	0.03	0.032	0.032	0.031
	RPM	6366	5809	5234	4711	4456	4191	3918	3683	3395	3143	2996	2829
	FEED	280	372	377	377	410	436	423	413	407	402	383	351
11.1	Vc	113	119	122	124	128	131	133	134	134	132	132	132
	fz	0.011	0.016	0.018	0.02	0.022	0.025	0.027	0.03	0.032	0.035	0.036	0.037
	RPM	10277	9470	8630	7894	7408	6950	6513	6093	5687	5252	4943	4669
11.2	FEED	452	606	621	632	652	695	703	731	728	735	712	691
	Vc	70	73	74	74	77	79	80	81	80	79	80	80
	fz	0.011	0.016	0.018	0.02	0.023	0.026	0.027	0.028	0.03	0.032	0.032	0.031
14.1	RPM	6366	5809	5234	4711	4456	4191	3918	3683	3395	3143	2996	2829
	FEED	280	372	377	377	410	436	423	413	407	402	383	351
	Vc	58	61	62	62	65	67	68	68	67	66	66	67
15	fz	0.011	0.015	0.017	0.02	0.022	0.024	0.026	0.029	0.031	0.035	0.036	0.036
	RPM	5275	4854	4386	3947	3762	3554	3330	3092	2844	2626	2472	2370
	FEED	232	291	298	316	331	341	346	359	353	368	356	341
20	Vc	113	119	122	124	128	131	133	134	134	132	132	132
	fz	0.011	0.016	0.018	0.02	0.022	0.025	0.027	0.03	0.032	0.035	0.036	0.037
	RPM	10277	9470	8630	7894	7408	6950	6513	6093	5687	5252	4943	4669
38.1	FEED	452	606	621	632	652	695	703	731	728	735	712	691
	Vc	43	46	47	46	47	47	49	51	52	53	53	54
	fz	0.004	0.004	0.005	0.006	0.007	0.009	0.01	0.011	0.013	0.014	0.014	0.014
38.2	RPM	3911	3661	3325	2928	2720	2493	2400	2319	2207	2109	1985	1910
	FEED	63	59	66	70	76	90	96	102	115	118	111	107
	Vc	70	73	74	74	77	79	80	81	80	79	80	80
40	fz	0.011	0.016	0.018	0.02	0.023	0.026	0.027	0.028	0.03	0.032	0.032	0.031
	RPM	6366	5809	5234	4711	4456	4191	3918	3683	3395	3143	2996	2829
	FEED	280	372	377	377	410	436	423	413	407	402	383	351
41	Vc	43	46	47	46	47	47	49	51	52	53	53	54
	fz	0.004	0.004	0.005	0.006	0.007	0.009	0.01	0.011	0.013	0.014	0.014	0.014
	RPM	3911	3661	3325	2928	2720	2493	2400	2319	2207	2109	1985	1910
41	FEED	63	59	66	70	76	90	96	102	115	118	111	107

▶ NEXT PAGE

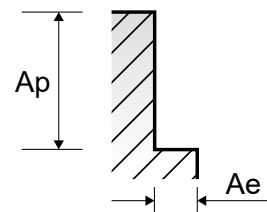

HSS

CBN END MILLS

i-Xmill END MILLS

i-SMART MODULAR END MILLS

X5070 END MILLS

4G MILL END MILLS

X-POWER PRO END MILLS

TitaNox-POWER END MILLS

JET-POWER END MILLS

V7 PLUS END MILLS

ALU-POWER HPC END MILLS

ALU-POWER END MILLS

D-POWER GRAPHITE END MILLS

D-POWER CFRP END MILLS

ROUTERS

CRX S END MILLS

K-2 END MILLS

ONLY ONE COATED PM60 END MILLS

TANK-POWER END MILLS

GENERAL HSS END MILLS

MILLING CUTTERS

TECHNICAL DATA

SEME36, SEME71 SERIES 4 FLUTE - SIDE CUTTING

Vc = m/min.
fz = mm/tooth
RPM = rev./min.
FEED = mm/min.

ISO	VDI 3323	Ae	Ap	Parameter	Diameter (Ø)							
					9.5	10.0	10.5	11.0	11.5	12.0	13.0	14.0
P	1-5	0.05D	1.0D	Vc	130	128	129	130	130	129	133	136
				fz	0.038	0.039	0.04	0.04	0.04	0.04	0.04	
				RPM	4356	4074	3911	3762	3598	3422	3257	3092
	6-8	0.05D	1.0D	Vc	130	128	129	130	130	129	133	136
				fz	0.038	0.039	0.04	0.04	0.04	0.04	0.04	
				RPM	4356	4074	3911	3762	3598	3422	3257	3092
	9	0.05D	1.0D	Vc	79	79	79	79	79	79	82	84
				fz	0.031	0.032	0.032	0.032	0.032	0.032	0.031	0.031
				RPM	2647	2515	2395	2286	2187	2096	2008	1910
	10-11.1	0.05D	1.0D	Vc	130	128	129	130	130	129	133	136
				fz	0.038	0.039	0.04	0.04	0.04	0.04	0.04	
				RPM	4356	4074	3911	3762	3598	3422	3257	3092
11.2	0.05D	1.0D	Vc	79	79	79	79	79	79	82	84	
			fz	0.031	0.032	0.032	0.032	0.032	0.032	0.031	0.031	
			RPM	2647	2515	2395	2286	2187	2096	2008	1910	
M	14.1	0.05D	1.0D	Vc	67	66	66	66	65	64	66	68
				fz	0.037	0.038	0.038	0.038	0.038	0.037	0.037	
				RPM	2245	2101	2001	1910	1799	1698	1616	1546
K	15-20	0.05D	1.0D	Vc	130	128	129	130	130	129	133	136
				fz	0.038	0.039	0.04	0.04	0.04	0.04	0.04	
				RPM	4356	4074	3911	3762	3598	3422	3257	3092
H	38.1 - 38.2	0.05D	1.0D	Vc	54	53	54	55	55	55	56	57
				fz	0.014	0.014	0.014	0.014	0.015	0.015	0.015	
				RPM	1809	1687	1637	1592	1522	1459	1371	1296
H	40	0.05D	1.0D	Vc	79	79	79	79	79	79	82	84
				fz	0.031	0.032	0.032	0.032	0.032	0.032	0.031	0.031
				RPM	2647	2515	2395	2286	2187	2096	2008	1910
H	41	0.05D	1.0D	Vc	54	53	54	55	55	55	56	57
				fz	0.014	0.014	0.014	0.014	0.015	0.015	0.015	
				RPM	1809	1687	1637	1592	1522	1459	1371	1296

▶ NEXT PAGE

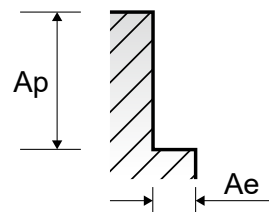

SEME36, SEME71 SERIES 4 FLUTE - SIDE CUTTING

Vc = m/min.
fz = mm/tooth
RPM = rev./min.
FEED = mm/min.

VDI 3323	Parameter	Diameter (Ø)										
		15.0	16.0	17.0	18.0	19.0	20.0	21.0	22.0	23.0	24.0	25.0
1-5	Vc	138	138	138	137	135	132	133	134	134	134	134
	fz	0.039	0.04	0.04	0.04	0.04	0.04	0.04	0.04	0.04	0.039	0.039
	RPM	2928	2745	2584	2423	2262	2101	2016	1939	1855	1777	1706
6-8	FEED	457	439	413	388	362	336	323	310	297	277	266
	Vc	138	138	138	137	135	132	133	134	134	134	134
	fz	0.039	0.04	0.04	0.04	0.04	0.04	0.04	0.04	0.04	0.039	0.039
9	RPM	2928	2745	2584	2423	2262	2101	2016	1939	1855	1777	1706
	FEED	457	439	413	388	362	336	323	310	297	277	266
	Vc	85	85	86	85	85	84	84	84	84	84	82
10	fz	0.031	0.032	0.031	0.031	0.032	0.032	0.032	0.033	0.031	0.032	0.032
	RPM	1804	1691	1610	1503	1424	1337	1273	1215	1163	1114	1044
	FEED	224	216	200	186	182	171	163	160	144	143	134
11.2	Vc	138	138	138	137	135	132	133	134	134	134	134
	fz	0.039	0.04	0.04	0.04	0.04	0.04	0.04	0.04	0.04	0.039	0.039
	RPM	2928	2745	2584	2423	2262	2101	2016	1939	1855	1777	1706
14.1	FEED	457	439	413	388	362	336	323	310	297	277	266
	Vc	85	85	86	85	85	84	84	84	84	84	82
	fz	0.031	0.032	0.031	0.031	0.032	0.032	0.032	0.033	0.031	0.032	0.032
15	RPM	1804	1691	1610	1503	1424	1337	1273	1215	1163	1114	1044
	FEED	224	216	200	186	182	171	163	160	144	143	134
	Vc	69	69	69	68	67	66	67	67	67	67	67
20	fz	0.038	0.038	0.039	0.038	0.039	0.038	0.037	0.037	0.038	0.037	0.037
	RPM	1464	1373	1292	1203	1122	1050	1016	969	927	889	853
	FEED	223	209	202	183	175	160	150	143	141	132	126
38.1	Vc	138	138	138	137	135	132	133	134	134	134	134
	fz	0.039	0.04	0.04	0.04	0.04	0.04	0.04	0.04	0.04	0.039	0.039
	RPM	2928	2745	2584	2423	2262	2101	2016	1939	1855	1777	1706
38.2	FEED	457	439	413	388	362	336	323	310	297	277	266
	Vc	57	57	57	56	55	53	54	54	54	54	53
	fz	0.014	0.014	0.014	0.014	0.014	0.013	0.012	0.013	0.013	0.012	0.012
40	RPM	1210	1134	1067	990	921	844	819	781	747	716	675
	FEED	68	64	60	55	48	40	43	41	36	32	32
	Vc	85	85	86	85	85	84	84	84	84	84	82
41	fz	0.031	0.032	0.031	0.031	0.032	0.032	0.032	0.033	0.031	0.032	0.032
	RPM	1804	1691	1610	1503	1424	1337	1273	1215	1163	1114	1044
	FEED	224	216	200	186	182	171	163	160	144	143	134
	Vc	57	57	57	56	55	53	54	54	54	54	53
	fz	0.014	0.014	0.014	0.014	0.013	0.012	0.013	0.013	0.012	0.011	0.012
	RPM	1210	1134	1067	990	921	844	819	781	747	716	675
	FEED	68	64	60	55	48	40	43	41	36	32	32

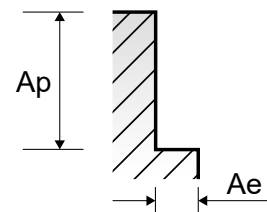

YG 4G MILL END MILLS

RECOMMENDED CUTTING CONDITIONS EMPFOLHENE SCHNEIDPARAMETER

SEME72 SERIES 4 FLUTE - SIDE CUTTING

Vc = m/min. fz = mm/tooth
RPM = rev./min. FEED = mm/min.
LOC = Length of Cut

ISO	VDI 3323	Material Description	Ae	Ap	Parameter	Diameter (Ø)															
						1.0	1.0	1.0	1.0	1.0	1.0	1.0	1.0	1.2	1.2	1.2	1.2				
						LOC 3	4	5	6	7	8	10	12	4	6	8	10				
P	1-5	Non-alloy steel	0.05D	2.5D	Vc	60	60	60	54	54	54	54	48	61	61	55	55				
					fz	0.002	0.002	0.002	0.002	0.002	0.002	0.002	0.002	0.003	0.003	0.003	0.002				
					RPM	19099	19099	19099	17189	17189	17189	17189	15279	16181	16181	14589	14589				
	6-8	Low alloy steel	0.05D	2.5D	Vc	60	60	60	54	54	54	54	48	61	61	55	55				
					fz	0.002	0.002	0.002	0.002	0.002	0.002	0.002	0.002	0.003	0.003	0.003	0.002				
					RPM	19099	19099	19099	17189	17189	17189	17189	15279	16181	16181	14589	14589				
	9	High alloyed steel, and tool steel	0.05D	2.5D	Vc	34	34	34	31	31	31	31	28	35	35	31	31				
					fz	0.002	0.002	0.002	0.002	0.002	0.001	0.001	0.001	0.002	0.002	0.002	0.002				
					RPM	10823	10823	10823	9868	9868	9868	9868	8913	9284	9284	8223	8223				
	10-11.1	High alloyed steel, and tool steel	0.05D	2.5D	Vc	60	60	60	54	54	54	54	48	61	61	55	55				
					fz	0.002	0.002	0.002	0.002	0.002	0.002	0.002	0.002	0.003	0.003	0.003	0.002				
					RPM	19099	19099	19099	17189	17189	17189	17189	15279	16181	16181	14589	14589				
11.2	High alloyed steel, and tool steel	0.05D	2.5D	Vc	34	34	34	31	31	31	31	28	35	35	31	31					
				fz	0.002	0.002	0.002	0.002	0.002	0.001	0.001	0.001	0.002	0.002	0.002	0.002					
				RPM	10823	10823	10823	9868	9868	9868	9868	8913	9284	9284	8223	8223					
K	15-20	Grey cast iron Nodular cast iron Malleable cast iron	0.05D	2.5D	Vc	60	60	60	54	54	54	54	48	61	61	55	55				
					fz	0.002	0.002	0.002	0.002	0.002	0.002	0.002	0.002	0.003	0.003	0.003	0.002				
					RPM	19099	19099	19099	17189	17189	17189	17189	15279	16181	16181	14589	14589				
H	38.1 - 38.2	Hardened steel	0.02D	2.0D	Vc	21	21	21	19	19	19	19	17	21	21	19	19				
					fz	0.001	0.001	0.001	0.001	0.001	0.001	0.001	0.001	0.002	0.002	0.002	0.001				
					RPM	6685	6685	6685	6048	6048	6048	6048	5411	5570	5570	5040	5040				
40	Chilled Cast Iron	0.05D	2.5D	Vc	34	34	34	31	31	31	31	28	35	35	31	31					
				fz	0.002	0.002	0.002	0.002	0.002	0.001	0.001	0.001	0.002	0.002	0.002	0.002					
				RPM	10823	10823	10823	9868	9868	9868	9868	8913	9284	9284	8223	8223					
41	Hardened Cast Iron	0.02D	2.0D	Vc	21	21	21	19	19	19	19	17	21	21	19	19					
				fz	0.001	0.001	0.001	0.001	0.001	0.001	0.001	0.001	0.002	0.002	0.002	0.001					
				RPM	6685	6685	6685	6048	6048	6048	6048	5411	5570	5570	5040	5040					

▶ NEXT PAGE

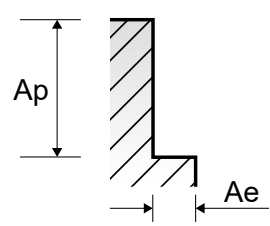

YG 4G MILL END MILLS

RECOMMENDED CUTTING CONDITIONS EMPFOHLENE SCHNEIDPARAMETER

SEME72 SERIES 4 FLUTE - SIDE CUTTING

Vc = m/min. fz = mm/tooth
RPM = rev./min. FEED = mm/min.
LOC = Length of Cut

VDI 3323	Parameter	Diameter (∅)																		
		1.2	1.5	1.5	1.5	1.5	1.5	1.5	1.5	2.0	2.0	2.0	2.0	2.0	2.5	2.5	2.5	2.5	2.5	3.0
	LOC	12	6	8	10	12	14	16	8	10	12	14	16	10	12	16	20	26	10	12
1-5	Vc	55	65	59	59	59	59	52	66	66	60	60	60	71	71	64	64	57	70	70
	fz	0.002	0.004	0.004	0.004	0.003	0.003	0.003	0.006	0.006	0.005	0.005	0.005	0.007	0.007	0.006	0.006	0.005	0.009	0.009
	RPM	14589	13793	12520	12520	12520	12520	11035	10504	10504	9549	9549	9549	9040	9040	8149	8149	7257	7427	7427
6-8	Vc	55	65	59	59	59	59	52	66	66	60	60	60	71	71	64	64	57	70	70
	fz	0.002	0.004	0.004	0.004	0.003	0.003	0.003	0.006	0.006	0.005	0.005	0.005	0.007	0.007	0.006	0.006	0.005	0.009	0.009
	RPM	14589	13793	12520	12520	12520	12520	11035	10504	10504	9549	9549	9549	9040	9040	8149	8149	7257	7427	7427
9	Vc	31	37	33	33	33	33	30	38	38	34	34	34	41	41	37	37	32	40	40
	fz	0.002	0.003	0.003	0.002	0.002	0.002	0.002	0.004	0.004	0.004	0.004	0.003	0.005	0.005	0.005	0.004	0.004	0.007	0.007
	RPM	8223	7852	7003	7003	7003	7003	6366	6048	6048	5411	5411	5411	5220	5220	4711	4711	4074	4244	4244
10 - 11.1	Vc	55	65	59	59	59	59	52	66	66	60	60	60	71	71	64	64	57	70	70
	fz	0.002	0.004	0.004	0.004	0.003	0.003	0.003	0.006	0.006	0.005	0.005	0.005	0.007	0.007	0.006	0.006	0.005	0.009	0.009
	RPM	14589	13793	12520	12520	12520	12520	11035	10504	10504	9549	9549	9549	9040	9040	8149	8149	7257	7427	7427
11.2	Vc	31	37	33	33	33	33	30	38	38	34	34	34	41	41	37	37	32	40	40
	fz	0.002	0.003	0.003	0.002	0.002	0.002	0.002	0.004	0.004	0.004	0.004	0.003	0.005	0.005	0.005	0.004	0.004	0.007	0.007
	RPM	8223	7852	7003	7003	7003	7003	6366	6048	6048	5411	5411	5411	5220	5220	4711	4711	4074	4244	4244
15 - 20	Vc	55	65	59	59	59	59	52	66	66	60	60	60	71	71	64	64	57	70	70
	fz	0.002	0.004	0.004	0.004	0.003	0.003	0.003	0.006	0.006	0.005	0.005	0.005	0.007	0.007	0.006	0.006	0.005	0.009	0.009
	RPM	14589	13793	12520	12520	12520	12520	11035	10504	10504	9549	9549	9549	9040	9040	8149	8149	7257	7427	7427
38.1 - 38.2	Vc	19	23	20	20	20	20	18	24	24	21	21	21	25	25	23	23	20	25	25
	fz	0.001	0.002	0.002	0.002	0.002	0.002	0.002	0.004	0.004	0.003	0.003	0.003	0.005	0.005	0.004	0.004	0.003	0.006	0.006
	RPM	5040	4881	4244	4244	4244	4244	3820	3820	3820	3342	3342	3342	3183	3183	2928	2928	2546	2653	2653
40	Vc	31	37	33	33	33	33	30	38	38	34	34	34	41	41	37	37	32	40	40
	fz	0.002	0.003	0.003	0.002	0.002	0.002	0.002	0.004	0.004	0.004	0.004	0.003	0.005	0.005	0.005	0.004	0.004	0.007	0.007
	RPM	8223	7852	7003	7003	7003	7003	6366	6048	6048	5411	5411	5411	5220	5220	4711	4711	4074	4244	4244
41	Vc	19	23	20	20	20	20	18	24	24	21	21	21	25	25	23	23	20	25	25
	fz	0.001	0.002	0.002	0.002	0.002	0.002	0.002	0.004	0.004	0.003	0.003	0.003	0.005	0.005	0.004	0.004	0.003	0.006	0.006
	RPM	5040	4881	4244	4244	4244	4244	3820	3820	3820	3342	3342	3342	3183	3183	2928	2928	2546	2653	2653
	FEED	117	221	200	200	150	150	132	252	252	191	191	191	253	253	196	196	145	267	267

▶ NEXT PAGE

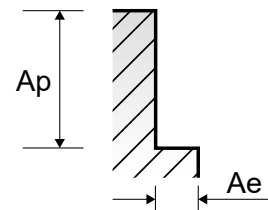

SEME72 SERIES 4 FLUTE - SIDE CUTTING

Vc = m/min. fz = mm/tooth
RPM = rev./min. FEED = mm/min.
LOC = Length of Cut

ISO	VDI 3323	Ae	Ap	Parameter	Diameter (Ø)															
					3.0	3.0	3.0	3.0	3.0	4.0	4.0	4.0	4.0	4.0	5.0	5.0	5.0	5.0	5.0	
P	1-5	0.05D	2.5D	LOC	14	16	20	26	30	12	16	20	26	30	20	25	30	35	40	
				Vc	70	63	63	63	63	75	75	75	68	68	80	80	72	72	72	
				fz	0.009	0.009	0.008	0.008	0.008	0.014	0.014	0.014	0.013	0.013	0.021	0.021	0.019	0.019	0.017	
	6-8	0.05D	2.5D	RPM	7427	6685	6685	6685	6685	5968	5968	5968	5411	5411	5093	5093	4584	4584	4584	
				FEED	267	241	214	214	214	334	334	334	281	281	428	428	348	348	312	
				Vc	70	63	63	63	63	75	75	75	68	68	80	80	72	72	72	
	9	0.05D	2.5D	fz	0.009	0.009	0.008	0.008	0.008	0.014	0.014	0.014	0.013	0.013	0.021	0.021	0.019	0.019	0.017	
				RPM	7427	6685	6685	6685	6685	5968	5968	5968	5411	5411	5093	5093	4584	4584	4584	
				FEED	267	241	214	214	214	334	334	334	281	281	428	428	348	348	312	
	10-11.1	0.05D	2.5D	Vc	40	36	36	36	36	43	43	43	39	39	46	46	41	41	41	
				fz	0.007	0.007	0.006	0.006	0.006	0.01	0.01	0.01	0.009	0.009	0.015	0.015	0.013	0.013	0.011	
				RPM	4244	3820	3820	3820	3820	3422	3422	3422	3104	3104	2928	2928	2610	2610	2610	
11.2	0.05D	2.5D	FEED	119	107	92	92	92	137	137	137	112	112	176	176	136	136	115		
			Vc	70	63	63	63	63	75	75	75	68	68	80	80	72	72	72		
			fz	0.009	0.009	0.008	0.008	0.008	0.014	0.014	0.014	0.013	0.013	0.021	0.021	0.019	0.019	0.017		
K	15-20	0.05D	2.5D	RPM	7427	6685	6685	6685	6685	5968	5968	5968	5411	5411	5093	5093	4584	4584	4584	
				FEED	267	241	214	214	214	334	334	334	281	281	428	428	348	348	312	
				Vc	25	22	22	22	22	27	27	27	24	24	30	30	27	27	27	
H	38.1 - 38.2	0.02D	2.0D	fz	0.006	0.006	0.006	0.005	0.005	0.008	0.008	0.008	0.008	0.008	0.011	0.011	0.01	0.01	0.009	
				RPM	2653	2334	2334	2334	2334	2149	2149	2149	1910	1910	1910	1910	1719	1719	1719	
				FEED	64	56	56	47	47	69	69	69	61	61	84	84	69	69	62	
H	40	0.05D	2.5D	Vc	40	36	36	36	36	43	43	43	39	39	46	46	41	41	41	
				fz	0.007	0.007	0.006	0.006	0.006	0.01	0.01	0.01	0.009	0.009	0.015	0.015	0.013	0.013	0.011	
				RPM	4244	3820	3820	3820	3820	3422	3422	3422	3104	3104	2928	2928	2610	2610	2610	
H	41	0.02D	2.0D	FEED	119	107	92	92	92	137	137	137	112	112	176	176	136	136	115	
				Vc	25	22	22	22	22	27	27	27	24	24	30	30	27	27	27	
				fz	0.006	0.006	0.006	0.005	0.005	0.008	0.008	0.008	0.008	0.008	0.011	0.011	0.01	0.01	0.009	
H	41	0.02D	2.0D	RPM	2653	2334	2334	2334	2334	2149	2149	2149	1910	1910	1910	1910	1719	1719	1719	
				FEED	64	56	56	47	47	69	69	69	61	61	84	84	69	69	62	

▶ NEXT PAGE

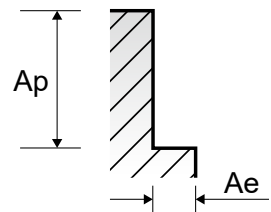

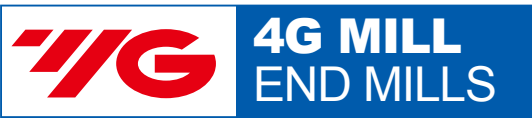

**RECOMMENDED CUTTING CONDITIONS
EMPFOHLENE SCHNEIDPARAMETER**

SEME72 SERIES 4 FLUTE - SIDE CUTTING

Vc = m/min. fz = mm/tooth
RPM = rev./min. FEED = mm/min.
LOC = Length of Cut

VDI 3323	Parameter	Diameter (Ø)																			
		6.0	6.0	6.0	6.0	6.0	6.0	6.0	6.0	8.0	8.0	8.0	8.0	8.0	8.0	10.0	10.0	10.0	10.0	10.0	10.0
	LOC	15	20	25	30	35	40	45	25	30	35	40	45	50	30	35	40	45	50	55	
1-5	Vc	83	83	83	83	75	75	75	84	84	84	84	84	76	76	89	89	89	89	89	80
	fz	0.029	0.029	0.029	0.025	0.025	0.022	0.022	0.041	0.041	0.041	0.041	0.041	0.035	0.035	0.031	0.049	0.049	0.049	0.042	0.041
	RPM	4403	4403	4403	4403	3979	3979	3979	3342	3342	3342	3342	3342	3342	3024	3024	2833	2833	2833	2833	2546
	FEED	511	511	511	440	398	350	350	548	548	548	548	468	423	375	555	555	555	476	476	418
6-8	Vc	83	83	83	83	75	75	75	84	84	84	84	84	76	76	89	89	89	89	89	80
	fz	0.029	0.029	0.029	0.025	0.025	0.022	0.022	0.041	0.041	0.041	0.041	0.041	0.035	0.035	0.031	0.049	0.049	0.049	0.042	0.041
	RPM	4403	4403	4403	4403	3979	3979	3979	3342	3342	3342	3342	3342	3342	3024	3024	2833	2833	2833	2833	2546
	FEED	511	511	511	440	398	350	350	548	548	548	548	468	423	375	555	555	555	476	476	418
9	Vc	48	48	48	48	43	43	43	48	48	48	48	48	43	43	52	52	52	52	52	46
	fz	0.021	0.021	0.021	0.018	0.018	0.016	0.016	0.028	0.028	0.028	0.028	0.028	0.024	0.024	0.021	0.033	0.033	0.033	0.028	0.028
	RPM	2546	2546	2546	2546	2281	2281	2281	1910	1910	1910	1910	1910	1910	1711	1711	1655	1655	1655	1655	1464
	FEED	214	214	214	183	164	146	146	214	214	214	214	183	164	144	218	218	218	185	185	164
10 - 11.1	Vc	83	83	83	83	75	75	75	84	84	84	84	84	76	76	89	89	89	89	89	80
	fz	0.029	0.029	0.029	0.025	0.025	0.022	0.022	0.041	0.041	0.041	0.041	0.041	0.035	0.035	0.031	0.049	0.049	0.049	0.042	0.041
	RPM	4403	4403	4403	4403	3979	3979	3979	3342	3342	3342	3342	3342	3342	3024	3024	2833	2833	2833	2833	2546
	FEED	511	511	511	440	398	350	350	548	548	548	548	468	423	375	555	555	555	476	476	418
11.2	Vc	48	48	48	48	43	43	43	48	48	48	48	48	43	43	52	52	52	52	52	46
	fz	0.021	0.021	0.021	0.018	0.018	0.016	0.016	0.028	0.028	0.028	0.028	0.028	0.024	0.024	0.021	0.033	0.033	0.033	0.028	0.028
	RPM	2546	2546	2546	2546	2281	2281	2281	1910	1910	1910	1910	1910	1910	1711	1711	1655	1655	1655	1655	1464
	FEED	214	214	214	183	164	146	146	214	214	214	214	183	164	144	218	218	218	185	185	164
15 - 20	Vc	83	83	83	83	75	75	75	84	84	84	84	84	76	76	89	89	89	89	89	80
	fz	0.029	0.029	0.029	0.025	0.025	0.022	0.022	0.041	0.041	0.041	0.041	0.041	0.035	0.035	0.031	0.049	0.049	0.049	0.042	0.041
	RPM	4403	4403	4403	4403	3979	3979	3979	3342	3342	3342	3342	3342	3342	3024	3024	2833	2833	2833	2833	2546
	FEED	511	511	511	440	398	350	350	548	548	548	548	468	423	375	555	555	555	476	476	418
38.1 - 38.2	Vc	31	31	31	31	28	28	28	32	32	32	32	32	28	28	32	32	32	32	32	29
	fz	0.017	0.017	0.017	0.014	0.014	0.013	0.013	0.022	0.022	0.022	0.022	0.022	0.018	0.017	0.027	0.027	0.027	0.022	0.022	0.023
	RPM	1645	1645	1645	1645	1485	1485	1485	1273	1273	1273	1273	1273	1114	1114	1019	1019	1019	1019	1019	923
	FEED	112	112	112	92	83	77	77	112	112	112	112	92	85	76	110	110	110	90	90	85
40	Vc	48	48	48	48	43	43	43	48	48	48	48	48	43	43	52	52	52	52	52	46
	fz	0.021	0.021	0.021	0.018	0.018	0.016	0.016	0.028	0.028	0.028	0.028	0.028	0.024	0.024	0.021	0.033	0.033	0.033	0.028	0.028
	RPM	2546	2546	2546	2546	2281	2281	2281	1910	1910	1910	1910	1910	1910	1711	1711	1655	1655	1655	1655	1464
	FEED	214	214	214	183	164	146	146	214	214	214	214	183	164	144	218	218	218	185	185	164
41	Vc	31	31	31	31	28	28	28	32	32	32	32	32	28	28	32	32	32	32	32	29
	fz	0.017	0.017	0.017	0.014	0.014	0.013	0.013	0.022	0.022	0.022	0.022	0.022	0.018	0.019	0.017	0.027	0.027	0.027	0.022	0.023
	RPM	1645	1645	1645	1645	1485	1485	1485	1273	1273	1273	1273	1273	1114	1114	1019	1019	1019	1019	1019	923
	FEED	112	112	112	92	83	77	77	112	112	112	112	92	85	76	110	110	110	90	90	85

▶ NEXT PAGE

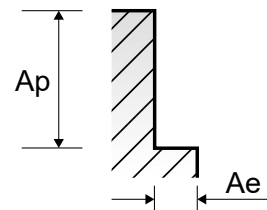

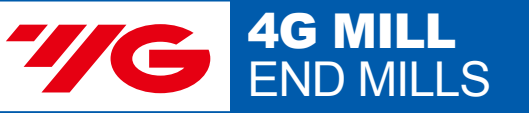

RECOMMENDED CUTTING CONDITIONS
EMPFOHLENE SCHNEIDPARAMETER

SEME72 SERIES 4 FLUTE - SIDE CUTTING

Vc = m/min. fz = mm/tooth
RPM = rev./min. FEED = mm/min.
LOC = Length of Cut

ISO	VDI 3323	Ae	Ap	Parameter	Diameter (Ø)																
					10.0	12.0	12.0	12.0	12.0	12.0	12.0	12.0	12.0	14.0	14.0	16.0	16.0	16.0	16.0		
					LOC	60	35	40	45	50	55	60	65	70	50	60	40	50	60	70	
P	1-5	0.05D	2.5D	Vc	80	87	87	87	87	87	87	87	87	78	78	93	93	98	98	98	98
				fz	0.037	0.047	0.047	0.04	0.04	0.04	0.04	0.04	0.035	0.035	0.035	0.041	0.041	0.05	0.05	0.042	0.042
				RPM	2546	2308	2308	2308	2308	2308	2308	2308	2308	2069	2069	2114	2114	1950	1950	1950	1950
	6-8	0.05D	2.5D	Vc	80	87	87	87	87	87	87	87	87	78	78	93	93	98	98	98	98
				fz	0.037	0.047	0.047	0.04	0.04	0.04	0.04	0.04	0.035	0.035	0.035	0.041	0.041	0.05	0.05	0.042	0.042
				RPM	2546	2308	2308	2308	2308	2308	2308	2308	2308	2069	2069	2114	2114	1950	1950	1950	1950
	9	0.05D	2.5D	Vc	46	52	52	52	52	52	52	52	47	47	54	54	54	54	54	54	54
				fz	0.024	0.034	0.034	0.03	0.03	0.03	0.03	0.03	0.026	0.026	0.026	0.029	0.029	0.035	0.035	0.03	0.03
				RPM	1464	1379	1379	1379	1379	1379	1379	1379	1379	1247	1247	1228	1228	1074	1074	1074	1074
	10-11.1	0.05D	2.5D	Vc	80	87	87	87	87	87	87	87	87	78	78	93	93	98	98	98	98
				fz	0.037	0.047	0.047	0.04	0.04	0.04	0.04	0.04	0.035	0.035	0.035	0.041	0.041	0.05	0.05	0.042	0.042
				RPM	2546	2308	2308	2308	2308	2308	2308	2308	2308	2069	2069	2114	2114	1950	1950	1950	1950
11.2	0.05D	2.5D	Vc	46	52	52	52	52	52	52	52	47	47	54	54	54	54	54	54	54	
			fz	0.024	0.034	0.034	0.03	0.03	0.03	0.03	0.03	0.026	0.026	0.026	0.029	0.029	0.035	0.035	0.03	0.03	
			RPM	1464	1379	1379	1379	1379	1379	1379	1379	1379	1247	1247	1228	1228	1074	1074	1074	1074	
K	15-20	0.05D	2.5D	Vc	80	87	87	87	87	87	87	87	87	78	78	93	93	98	98	98	98
				fz	0.037	0.047	0.047	0.04	0.04	0.04	0.04	0.04	0.035	0.035	0.035	0.041	0.041	0.05	0.05	0.042	0.042
				RPM	2546	2308	2308	2308	2308	2308	2308	2308	2308	2069	2069	2114	2114	1950	1950	1950	1950
H	38.1 - 38.2	0.02D	2.0D	Vc	29	32	32	32	32	32	32	32	29	29	33	33	34	34	34	34	34
				fz	0.021	0.025	0.025	0.021	0.021	0.021	0.021	0.021	0.019	0.018	0.018	0.021	0.021	0.026	0.026	0.022	0.022
				RPM	923	849	849	849	849	849	849	849	849	769	769	750	750	676	676	676	676
H	40	0.05D	2.5D	Vc	46	52	52	52	52	52	52	47	47	54	54	54	54	54	54	54	54
				fz	0.024	0.034	0.034	0.03	0.03	0.03	0.03	0.03	0.026	0.026	0.026	0.029	0.029	0.035	0.035	0.03	0.03
				RPM	1464	1379	1379	1379	1379	1379	1379	1379	1379	1247	1247	1228	1228	1074	1074	1074	1074
H	41	0.02D	2.0D	Vc	29	32	32	32	32	32	32	29	29	33	33	34	34	34	34	34	34
				fz	0.021	0.025	0.025	0.021	0.021	0.021	0.021	0.021	0.019	0.018	0.018	0.021	0.021	0.026	0.026	0.022	0.022
				RPM	923	849	849	849	849	849	849	849	849	769	769	750	750	676	676	676	676

▶ NEXT PAGE

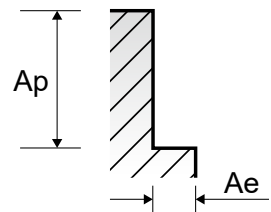

SEME72 SERIES 4 FLUTE - SIDE CUTTING

Vc = m/min. fz = mm/tooth
RPM = rev./min. FEED = mm/min.
LOC = Length of Cut

VDI 3323	Parameter	Diameter (Ø)																			
		16.0	16.0	16.0	16.0	18.0	18.0	18.0	20.0	20.0	20.0	20.0	20.0	20.0	20.0	22.0	22.0	25.0	25.0	25.0	25.0
	LOC	80	90	110	120	50	70	100	50	60	70	80	90	110	120	75	110	70	90	110	120
1-5	Vc	98	88	88	88	95	95	85	89	89	89	89	89	80	80	87	87	86	86	86	86
	fz	0.037	0.037	0.037	0.037	0.049	0.042	0.037	0.048	0.048	0.041	0.041	0.036	0.036	0.036	0.041	0.036	0.049	0.042	0.042	0.036
	RPM	1950	1751	1751	1751	1680	1680	1503	1416	1416	1416	1416	1416	1273	1273	1259	1259	1095	1095	1095	1095
6-8	FEED	289	259	259	259	329	282	222	272	272	232	232	204	183	183	206	181	215	184	184	158
	Vc	98	88	88	88	95	95	85	89	89	89	89	89	80	80	87	87	86	86	86	86
	fz	0.037	0.037	0.037	0.037	0.049	0.042	0.037	0.048	0.048	0.041	0.041	0.036	0.036	0.036	0.041	0.036	0.049	0.042	0.042	0.036
9	RPM	1950	1751	1751	1751	1680	1680	1503	1416	1416	1416	1416	1416	1273	1273	1259	1259	1095	1095	1095	1095
	FEED	289	259	259	259	329	282	222	272	272	232	232	204	183	183	206	181	215	184	184	158
	Vc	54	48	48	48	53	53	48	52	52	52	52	52	46	46	57	57	64	64	64	64
10 - 11.1	fz	0.027	0.026	0.026	0.026	0.035	0.029	0.025	0.034	0.034	0.027	0.027	0.024	0.026	0.026	0.027	0.024	0.034	0.027	0.027	0.024
	RPM	1074	955	955	955	937	937	849	828	828	828	828	828	732	732	825	825	815	815	815	815
	FEED	116	99	99	99	131	109	85	113	113	89	89	79	76	76	89	79	111	88	88	78
15 - 20	Vc	98	88	88	88	95	95	85	89	89	89	89	89	80	80	87	87	86	86	86	86
	fz	0.037	0.037	0.037	0.037	0.049	0.042	0.037	0.048	0.048	0.041	0.041	0.036	0.036	0.036	0.041	0.036	0.049	0.042	0.042	0.036
	RPM	1950	1751	1751	1751	1680	1680	1503	1416	1416	1416	1416	1416	1273	1273	1259	1259	1095	1095	1095	1095
38.1 - 38.2	FEED	289	259	259	259	329	282	222	272	272	232	232	204	183	183	206	181	215	184	184	158
	Vc	34	30	30	30	33	33	30	31	31	31	31	31	28	28	35	35	39	39	39	39
	fz	0.021	0.021	0.021	0.021	0.028	0.023	0.021	0.028	0.028	0.023	0.023	0.02	0.019	0.019	0.023	0.02	0.028	0.023	0.023	0.02
40	RPM	676	597	597	597	584	584	531	493	493	493	493	493	446	446	506	506	497	497	497	497
	FEED	57	50	50	50	65	54	45	55	55	45	45	39	34	34	47	41	56	46	46	40
	Vc	54	48	48	48	53	53	48	52	52	52	52	52	46	46	57	57	64	64	64	64
41	fz	0.027	0.026	0.026	0.026	0.035	0.029	0.025	0.034	0.034	0.027	0.027	0.024	0.026	0.026	0.027	0.024	0.034	0.027	0.027	0.024
	RPM	1074	955	955	955	937	937	849	828	828	828	828	828	732	732	825	825	815	815	815	815
	FEED	116	99	99	99	131	109	85	113	113	89	89	79	76	76	89	79	111	88	88	78
41	Vc	34	30	30	30	33	33	30	31	31	31	31	31	28	28	35	35	39	39	39	39
	fz	0.021	0.021	0.021	0.021	0.028	0.023	0.021	0.028	0.028	0.023	0.023	0.02	0.019	0.019	0.023	0.02	0.028	0.023	0.023	0.02
	RPM	676	597	597	597	584	584	531	493	493	493	493	493	446	446	506	506	497	497	497	497
41	FEED	57	50	50	50	65	54	45	55	55	45	45	39	34	34	47	41	56	46	46	40

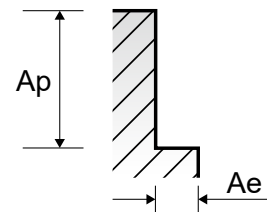

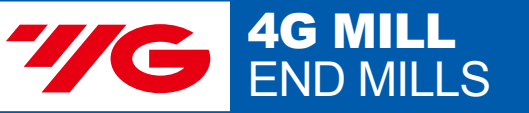

RECOMMENDED CUTTING CONDITIONS
EMPFOHLENE SCHNEIDPARAMETER

SEME73 SERIES

4 FLUTE - SIDE CUTTING

Vc = m/min. fz = mm/tooth
RPM = rev./min. FEED = mm/min.
Ae = mm LBS = Length Below Shank

ISO	VDI 3323	Material Description	Parameter	Diameter (Ø)																	
				1.0	1.0	1.0	1.0	1.0	1.0	1.0	1.0	1.0	1.0	1.0	1.0	1.0	1.0	1.0	1.0		
				LBS	2	3	4	5	6	7	8	10	12	14	16	18	20	22	26	30	40
P	1-5	Non-alloy steel	Vc	69	69	69	69	62	62	62	62	55	55	41	41	41	21	21	21	7	
			fz	0.004	0.004	0.004	0.004	0.003	0.003	0.003	0.003	0.003	0.003	0.002	0.002	0.002	0.002	0.002	0.002	0.002	
			RPM	21963	21963	21963	21963	19735	19735	19735	19735	17507	17507	13051	13051	13051	6685	6685	6685	2228	
			FEED	351	351	351	351	237	237	237	237	210	210	104	104	104	53	53	53	18	
	6-8	Low alloy steel	Vc	69	69	69	69	62	62	62	62	55	55	41	41	41	21	21	21	7	
			fz	0.004	0.004	0.004	0.004	0.003	0.003	0.003	0.003	0.003	0.003	0.002	0.002	0.002	0.002	0.002	0.002	0.002	
			RPM	21963	21963	21963	21963	19735	19735	19735	19735	17507	17507	13051	13051	13051	6685	6685	6685	2228	
			FEED	351	351	351	351	237	237	237	237	210	210	104	104	104	53	53	53	18	
	9	High alloyed steel, and tool steel	Vc	42	42	42	42	38	38	38	38	34	34	25	25	25	13	13	13	4	
			fz	0.003	0.003	0.003	0.003	0.003	0.003	0.003	0.003	0.003	0.003	0.002	0.002	0.002	0.002	0.002	0.002	0.002	
			RPM	13369	13369	13369	13369	12096	12096	12096	12096	10823	10823	7958	7958	7958	4138	4138	4138	1273	
			FEED	160	160	160	160	145	145	145	145	130	130	64	64	64	33	33	33	10	
	10-11.1	High alloyed steel, and tool steel	Vc	69	69	69	69	62	62	62	62	55	55	41	41	41	21	21	21	7	
			fz	0.004	0.004	0.004	0.004	0.003	0.003	0.003	0.003	0.003	0.003	0.002	0.002	0.002	0.002	0.002	0.002	0.002	
			RPM	21963	21963	21963	21963	19735	19735	19735	19735	17507	17507	13051	13051	13051	6685	6685	6685	2228	
			FEED	351	351	351	351	237	237	237	237	210	210	104	104	104	53	53	53	18	
	11.2	High alloyed steel, and tool steel	Vc	42	42	42	42	38	38	38	38	34	34	25	25	25	13	13	13	4	
			fz	0.003	0.003	0.003	0.003	0.003	0.003	0.003	0.003	0.003	0.003	0.002	0.002	0.002	0.002	0.002	0.002	0.002	
			RPM	13369	13369	13369	13369	12096	12096	12096	12096	10823	10823	7958	7958	7958	4138	4138	4138	1273	
			FEED	160	160	160	160	145	145	145	145	130	130	64	64	64	33	33	33	10	
	K	15-20	Grey cast iron Nodular cast iron Malleable cast iron	Vc	69	69	69	69	62	62	62	62	55	55	41	41	41	21	21	21	7
				fz	0.004	0.004	0.004	0.004	0.003	0.003	0.003	0.003	0.003	0.003	0.002	0.002	0.002	0.002	0.002	0.002	0.002
				RPM	21963	21963	21963	21963	19735	19735	19735	19735	17507	17507	13051	13051	13051	6685	6685	6685	2228
				FEED	351	351	351	351	237	237	237	237	210	210	104	104	104	53	53	53	18
H	38.1 - 38.2	Hardened steel	Vc	27	27	27	27	24	24	24	24	21	21	16	16	16	8	8	8	3	
			fz	0.001	0.001	0.001	0.001	0.001	0.001	0.001	0.001	0.001	0.001	0.001	0.001	0.001	0.001	0.001	0.001	0.001	
			RPM	8594	8594	8594	8594	7639	7639	7639	7639	6685	6685	5093	5093	5093	2546	2546	2546	955	
			FEED	34	34	34	34	31	31	31	31	27	27	20	20	20	10	10	10	4	
	40	Chilled Cast Iron	Vc	42	42	42	42	38	38	38	38	34	34	25	25	25	13	13	13	4	
			fz	0.003	0.003	0.003	0.003	0.003	0.003	0.003	0.003	0.003	0.003	0.002	0.002	0.002	0.002	0.002	0.002	0.002	
			RPM	13369	13369	13369	13369	12096	12096	12096	12096	10823	10823	7958	7958	7958	4138	4138	4138	1273	
			FEED	160	160	160	160	145	145	145	145	130	130	64	64	64	33	33	33	10	
	41	Hardened Cast Iron	Vc	27	27	27	27	24	24	24	24	21	21	16	16	16	8	8	8	3	
			fz	0.001	0.001	0.001	0.001	0.001	0.001	0.001	0.001	0.001	0.001	0.001	0.001	0.001	0.001	0.001	0.001	0.001	
			RPM	8594	8594	8594	8594	7639	7639	7639	7639	6685	6685	5093	5093	5093	2546	2546	2546	955	
			FEED	34	34	34	34	31	31	31	31	27	27	20	20	20	10	10	10	4	

▶ NEXT PAGE

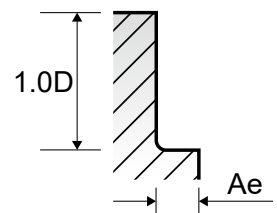

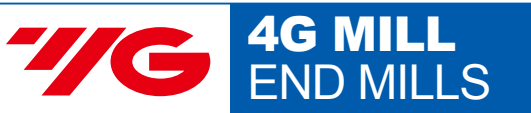

RECOMMENDED CUTTING CONDITIONS
EMPFOHLENE SCHNEIDPARAMETER

SEME73 SERIES

4 FLUTE - SIDE CUTTING

Vc = m/min. fz = mm/tooth
RPM = rev./min. FEED = mm/min.
Ae = mm LBS = Length Below Shank

ISO	VDI 3323	Parameter	Diameter (Ø)																				
			1.5		1.5		2.0		2.0		2.0		2.0		2.0		2.0		2.0		2.5		
			LBS	22	26	30	6	8	10	12	16	18	20	22	26	30	35	40	45	50	60	8	10
P	1-5	Vc	64	48	48	87	87	87	79	79	79	79	70	70	70	52	52	26	26	26	94	94	
		fz	0.004	0.003	0.003	0.006	0.006	0.006	0.005	0.005	0.005	0.005	0.005	0.005	0.005	0.004	0.004	0.004	0.004	0.004	0.004	0.007	0.007
		RPM	13581	10186	10186	13846	13846	13846	12573	12573	12573	12573	11141	11141	11141	8276	8276	4138	4138	4138	11968	11968	
		FEED	217	122	122	332	332	332	251	251	251	251	223	223	223	132	132	66	66	66	335	335	
	6-8	Vc	64	48	48	87	87	87	79	79	79	79	70	70	70	52	52	26	26	26	94	94	
		fz	0.004	0.003	0.003	0.006	0.006	0.006	0.005	0.005	0.005	0.005	0.005	0.005	0.005	0.004	0.004	0.004	0.004	0.004	0.004	0.007	0.007
		RPM	13581	10186	10186	13846	13846	13846	12573	12573	12573	12573	11141	11141	11141	8276	8276	4138	4138	4138	11968	11968	
		FEED	217	122	122	332	332	332	251	251	251	251	223	223	223	132	132	66	66	66	335	335	
	9	Vc	40	30	30	57	57	57	51	51	51	51	46	46	46	34	34	17	17	17	60	60	
		fz	0.004	0.003	0.003	0.006	0.006	0.006	0.005	0.005	0.005	0.005	0.004	0.004	0.004	0.004	0.004	0.003	0.003	0.003	0.007	0.007	
		RPM	8488	6366	6366	9072	9072	9072	8117	8117	8117	8117	7321	7321	7321	5411	5411	2706	2706	2706	7639	7639	
		FEED	136	76	76	218	218	218	162	162	162	162	117	117	117	87	87	32	32	32	214	214	
10-11.1	Vc	64	48	48	87	87	87	79	79	79	79	70	70	70	52	52	26	26	26	94	94		
	fz	0.004	0.003	0.003	0.006	0.006	0.006	0.005	0.005	0.005	0.005	0.005	0.005	0.005	0.004	0.004	0.004	0.004	0.004	0.007	0.007		
	RPM	13581	10186	10186	13846	13846	13846	12573	12573	12573	12573	11141	11141	11141	8276	8276	4138	4138	4138	11968	11968		
	FEED	217	122	122	332	332	332	251	251	251	251	223	223	223	132	132	66	66	66	335	335		
11.2	Vc	40	30	30	57	57	57	51	51	51	51	46	46	46	34	34	17	17	17	60	60		
	fz	0.004	0.003	0.003	0.006	0.006	0.006	0.005	0.005	0.005	0.005	0.004	0.004	0.004	0.004	0.004	0.003	0.003	0.003	0.007	0.007		
	RPM	8488	6366	6366	9072	9072	9072	8117	8117	8117	8117	7321	7321	7321	5411	5411	2706	2706	2706	7639	7639		
	FEED	136	76	76	218	218	218	162	162	162	162	117	117	117	87	87	32	32	32	214	214		
K	15-20	Vc	64	48	48	87	87	87	79	79	79	79	70	70	70	52	52	26	26	26	94	94	
		fz	0.004	0.003	0.003	0.006	0.006	0.006	0.005	0.005	0.005	0.005	0.005	0.005	0.005	0.004	0.004	0.004	0.004	0.004	0.007	0.007	
		RPM	13581	10186	10186	13846	13846	13846	12573	12573	12573	12573	11141	11141	11141	8276	8276	4138	4138	4138	11968	11968	
		FEED	217	122	122	332	332	332	251	251	251	251	223	223	223	132	132	66	66	66	335	335	
H	38.1 - 38.2	Vc	25	18	18	38	38	38	34	34	34	34	30	30	30	23	23	11	11	11	35	35	
		fz	0.001	0.001	0.001	0.003	0.003	0.003	0.002	0.002	0.002	0.002	0.002	0.002	0.002	0.002	0.002	0.001	0.001	0.001	0.003	0.003	
		RPM	5305	3820	3820	6048	6048	6048	5411	5411	5411	5411	4775	4775	4775	3661	3661	1751	1751	1751	4456	4456	
		FEED	21	15	15	73	73	73	43	43	43	43	38	38	38	29	29	7	7	7	53	53	
	40	Vc	40	30	30	57	57	57	51	51	51	51	46	46	46	34	34	17	17	17	60	60	
		fz	0.004	0.003	0.003	0.006	0.006	0.006	0.005	0.005	0.005	0.005	0.004	0.004	0.004	0.004	0.004	0.003	0.003	0.003	0.007	0.007	
		RPM	8488	6366	6366	9072	9072	9072	8117	8117	8117	8117	7321	7321	7321	5411	5411	2706	2706	2706	7639	7639	
		FEED	136	76	76	218	218	218	162	162	162	162	117	117	117	87	87	32	32	32	214	214	
	41	Vc	25	18	18	38	38	38	34	34	34	34	30	30	30	23	23	11	11	11	35	35	
		fz	0.001	0.001	0.001	0.003	0.003	0.003	0.002	0.002	0.002	0.002	0.002	0.002	0.002	0.002	0.002	0.001	0.001	0.001	0.003	0.003	
		RPM	5305	3820	3820	6048	6048	6048	5411	5411	5411	5411	4775	4775	4775	3661	3661	1751	1751	1751	4456	4456	
		FEED	21	15	15	73	73	73	43	43	43	43	38	38	38	29	29	7	7	7	53	53	

▶ NEXT PAGE

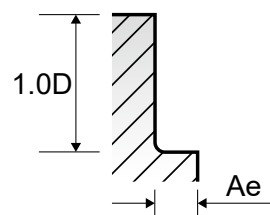

YG 4G MILL END MILLS

RECOMMENDED CUTTING CONDITIONS EMPFOLHENE SCHNEIDPARAMETER

SEME73 SERIES 4 FLUTE - SIDE CUTTING

Vc = m/min. fz = mm/tooth
RPM = rev./min. FEED = mm/min.
Ae = mm LBS = Length Below Shank

ISO	VDI 3323	Parameter	Diameter (Ø)																				
			3.0		3.0		3.0		3.0		3.0		4.0		4.0		4.0		4.0		4.0		
			LBS	30	35	40	45	50	60	8	10	12	14	16	18	20	22	26	30	35	40	45	50
P	1-5	Vc	91	81	81	81	61	61	114	114	114	114	114	114	114	103	103	103	103	103	91	91	
		fz	0.008	0.007	0.007	0.007	0.006	0.006	0.019	0.019	0.019	0.019	0.019	0.019	0.019	0.017	0.017	0.017	0.017	0.017	0.015	0.015	
		RPM	9655	8594	8594	8594	6472	6472	9072	9072	9072	9072	9072	9072	9072	8196	8196	8196	8196	8196	7242	7242	
		FEED	309	241	241	241	155	155	689	689	689	689	689	689	689	557	557	557	557	557	434	434	
	6-8	Vc	91	81	81	81	61	61	114	114	114	114	114	114	114	103	103	103	103	103	91	91	
		fz	0.008	0.007	0.007	0.007	0.006	0.006	0.019	0.019	0.019	0.019	0.019	0.019	0.019	0.017	0.017	0.017	0.017	0.017	0.015	0.015	
		RPM	9655	8594	8594	8594	6472	6472	9072	9072	9072	9072	9072	9072	9072	8196	8196	8196	8196	8196	7242	7242	
		FEED	309	241	241	241	155	155	689	689	689	689	689	689	689	557	557	557	557	557	434	434	
	9	Vc	57	50	50	50	38	38	70	70	70	70	70	70	70	63	63	63	63	63	56	56	
		fz	0.008	0.007	0.007	0.007	0.006	0.006	0.019	0.019	0.019	0.019	0.019	0.019	0.019	0.017	0.017	0.017	0.017	0.017	0.015	0.015	
		RPM	6048	5305	5305	5305	4032	4032	5570	5570	5570	5570	5570	5570	5570	5013	5013	5013	5013	5013	4456	4456	
		FEED	194	149	149	149	97	97	423	423	423	423	423	423	423	341	341	341	341	341	267	267	
	10-11.1	Vc	91	81	81	81	61	61	114	114	114	114	114	114	114	103	103	103	103	103	91	91	
		fz	0.008	0.007	0.007	0.007	0.006	0.006	0.019	0.019	0.019	0.019	0.019	0.019	0.019	0.017	0.017	0.017	0.017	0.017	0.015	0.015	
		RPM	9655	8594	8594	8594	6472	6472	9072	9072	9072	9072	9072	9072	9072	8196	8196	8196	8196	8196	7242	7242	
		FEED	309	241	241	241	155	155	689	689	689	689	689	689	689	557	557	557	557	557	434	434	
	11.2	Vc	57	50	50	50	38	38	70	70	70	70	70	70	70	63	63	63	63	63	56	56	
		fz	0.008	0.007	0.007	0.007	0.006	0.006	0.019	0.019	0.019	0.019	0.019	0.019	0.019	0.017	0.017	0.017	0.017	0.017	0.015	0.015	
		RPM	6048	5305	5305	5305	4032	4032	5570	5570	5570	5570	5570	5570	5570	5013	5013	5013	5013	5013	4456	4456	
		FEED	194	149	149	149	97	97	423	423	423	423	423	423	423	341	341	341	341	341	267	267	
	K	15-20	Vc	91	81	81	81	61	61	114	114	114	114	114	114	103	103	103	103	103	91	91	
			fz	0.008	0.007	0.007	0.007	0.006	0.006	0.019	0.019	0.019	0.019	0.019	0.019	0.019	0.017	0.017	0.017	0.017	0.017	0.015	0.015
			RPM	9655	8594	8594	8594	6472	6472	9072	9072	9072	9072	9072	9072	9072	8196	8196	8196	8196	8196	7242	7242
			FEED	309	241	241	241	155	155	689	689	689	689	689	689	689	557	557	557	557	557	434	434
H	38.1 - 38.2	Vc	34	30	30	30	23	23	44	44	44	44	44	44	44	40	40	40	40	40	35	35	
		fz	0.004	0.003	0.003	0.003	0.003	0.003	0.005	0.005	0.005	0.005	0.005	0.005	0.005	0.004	0.004	0.004	0.004	0.004	0.004	0.004	
		RPM	3608	3183	3183	3183	2440	2440	3501	3501	3501	3501	3501	3501	3501	3501	3183	3183	3183	3183	3183	2785	2785
		FEED	58	38	38	38	29	29	70	70	70	70	70	70	70	51	51	51	51	51	45	45	
	40	Vc	57	50	50	50	38	38	70	70	70	70	70	70	70	63	63	63	63	63	56	56	
		fz	0.008	0.007	0.007	0.007	0.006	0.006	0.019	0.019	0.019	0.019	0.019	0.019	0.019	0.017	0.017	0.017	0.017	0.017	0.015	0.015	
		RPM	6048	5305	5305	5305	4032	4032	5570	5570	5570	5570	5570	5570	5570	5013	5013	5013	5013	5013	4456	4456	
		FEED	194	149	149	149	97	97	423	423	423	423	423	423	423	341	341	341	341	341	267	267	
	41	Vc	34	30	30	30	23	23	44	44	44	44	44	44	44	40	40	40	40	40	35	35	
		fz	0.004	0.003	0.003	0.003	0.003	0.003	0.005	0.005	0.005	0.005	0.005	0.005	0.005	0.004	0.004	0.004	0.004	0.004	0.004	0.004	
		RPM	3608	3183	3183	3183	2440	2440	3501	3501	3501	3501	3501	3501	3501	3501	3183	3183	3183	3183	3183	2785	2785
		FEED	58	38	38	38	29	29	70	70	70	70	70	70	70	51	51	51	51	51	45	45	

▶ NEXT PAGE

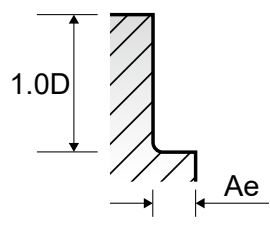

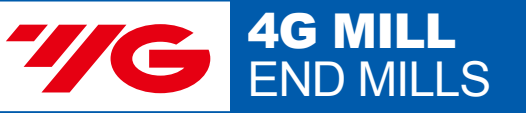

RECOMMENDED CUTTING CONDITIONS
EMPFOHLENE SCHNEIDPARAMETER

SEME75 SERIES 6 FLUTE - SIDE CUTTING

Vc = m/min. fz = mm/tooth
RPM = rev./min. FEED = mm/min.
LOC = Length of Cut

NORMAL SPEED

ISO	VDI 3323	Material Description	Ae	Ap	Parameter	Diameter (Ø)											
						6.0			8.0			10.0					
						LOC	15	20	30	20	30	35	40	25	30	40	
P	1-5	Non-alloy steel	0.1D	1.5D	Vc	110	110	110	111	111	111	111	111	111	111	111	
					fz	0.06	0.06	0.051	0.079	0.079	0.079	0.067	0.099	0.099	0.099		
					RPM	5836	5836	5836	4417	4417	4417	4417	3533	3533	3533		
					FEED	2101	2101	1786	2093	2093	2093	1775	2099	2099	2099		
	6-8	Low alloy steel	0.1D	1.5D	Vc	110	110	110	111	111	111	111	111	111	111	111	
					fz	0.06	0.06	0.051	0.079	0.079	0.079	0.067	0.099	0.099	0.099		
					RPM	5836	5836	5836	4417	4417	4417	4417	3533	3533	3533		
					FEED	2101	2101	1786	2093	2093	2093	1775	2099	2099	2099		
	9	Low alloy steel	0.05D	1.5D	Vc	77	77	77	78	78	78	78	78	76	76	76	
					fz	0.059	0.059	0.05	0.078	0.078	0.078	0.066	0.099	0.099	0.099		
					RPM	4085	4085	4085	3104	3104	3104	3104	2419	2419	2419		
					FEED	1446	1446	1225	1452	1452	1452	1229	1437	1437	1437		
10-11.1	High alloyed steel, and tool steel	0.1D	1.5D	Vc	110	110	110	111	111	111	111	111	111	111	111		
				fz	0.06	0.06	0.051	0.079	0.079	0.079	0.067	0.099	0.099	0.099			
				RPM	5836	5836	5836	4417	4417	4417	4417	3533	3533	3533			
				FEED	2101	2101	1786	2093	2093	2093	1775	2099	2099	2099			
11.2	High alloyed steel, and tool steel	0.05D	1.5D	Vc	77	77	77	78	78	78	78	78	76	76	76		
				fz	0.059	0.059	0.05	0.078	0.078	0.078	0.066	0.099	0.099	0.099			
				RPM	4085	4085	4085	3104	3104	3104	3104	2419	2419	2419			
				FEED	1446	1446	1225	1452	1452	1452	1229	1437	1437	1437			
K	15-20	Grey cast iron Nodular cast iron Malleable cast iron	0.1D	1.5D	Vc	110	110	110	111	111	111	111	111	111	111	111	
					fz	0.06	0.06	0.051	0.079	0.079	0.079	0.067	0.099	0.099	0.099		
					RPM	5836	5836	5836	4417	4417	4417	4417	3533	3533	3533		
					FEED	2101	2101	1786	2093	2093	2093	1775	2099	2099	2099		
H	38.1 - 38.2	Hardened steel	0.05D	1.0D	Vc	31	31	31	31	31	31	31	31	33	33	33	
					fz	0.022	0.022	0.019	0.03	0.03	0.03	0.026	0.035	0.035	0.035		
					RPM	1645	1645	1645	1233	1233	1233	1233	1050	1050	1050		
					FEED	217	217	187	222	222	222	192	221	221	221		
H	40	Chilled Cast Iron	0.05D	1.5D	Vc	77	77	77	78	78	78	78	78	76	76	76	
					fz	0.059	0.059	0.05	0.078	0.078	0.078	0.066	0.099	0.099	0.099		
					RPM	4085	4085	4085	3104	3104	3104	3104	2419	2419	2419		
					FEED	1446	1446	1225	1452	1452	1452	1229	1437	1437	1437		
H	41	Hardened Cast Iron	0.05D	1.0D	Vc	31	31	31	31	31	31	31	31	33	33	33	
					fz	0.022	0.022	0.019	0.03	0.03	0.03	0.026	0.035	0.035	0.035		
					RPM	1645	1645	1645	1233	1233	1233	1233	1050	1050	1050		
					FEED	217	217	187	222	222	222	192	221	221	221		

HIGH SPEED

ISO	VDI 3323	Material Description	Ae	Ap	Parameter	Diameter (Ø)											
						6.0			8.0			10.0					
						LOC	15	20	30	20	30	35	40	25	30	40	
P	11.2	High alloyed steel, and tool steel	0.05D	1.5D	Vc	333	333	333	333	333	333	333	333	329	329	329	
					fz	0.06	0.06	0.051	0.081	0.081	0.081	0.068	0.1	0.1	0.1		
					RPM	17666	17666	17666	13250	13250	13250	13250	10472	10472	10472		
					FEED	6360	6360	5406	6439	6439	6439	5406	6283	6283	6283		
H	38.1 - 38.2	Hardened steel	0.05D	1.0D	Vc	166	166	166	166	166	166	166	166	166	166	166	
					fz	0.061	0.061	0.051	0.081	0.081	0.081	0.069	0.101	0.101	0.101		
					RPM	8807	8807	8807	6605	6605	6605	6605	5284	5284	5284		
					FEED	3223	3223	2695	3210	3210	3210	2734	3202	3202	3202		
H	40	Chilled Cast Iron	0.05D	1.5D	Vc	333	333	333	333	333	333	333	333	329	329	329	
					fz	0.06	0.06	0.051	0.081	0.081	0.081	0.068	0.1	0.1	0.1		
					RPM	17666	17666	17666	13250	13250	13250	13250	10472	10472	10472		
					FEED	6360	6360	5406	6439	6439	6439	5406	6283	6283	6283		
H	41	Hardened Cast Iron	0.05D	1.0D	Vc	166	166	166	166	166	166	166	166	166	166	166	
					fz	0.061	0.061	0.051	0.081	0.081	0.081	0.069	0.101	0.101	0.101		
					RPM	8807	8807	8807	6605	6605	6605	6605	5284	5284	5284		
					FEED	3223	3223	2695	3210	3210	3210	2734	3202	3202	3202		

▶ NEXT PAGE

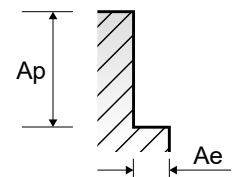

G9D75 G9D67 G9D76 G9D68 G9D77 G9D69

4&5 FLUTE CORNER RADIUS ROUGHING

Vc = m/min.
fz = mm/tooth
RPM = rev./min.
FEED = mm/min.

SLOTTING

ISO	VDI 3323	Material Description	Ae	Ap	Parameter	Diameter (Ø)					
						6.0	8.0	10.0	12.0	16.0	20.0
P	1-3	Non-alloy steel	1.0D	1.0D	Vc	225	225	225	225	225	225
					fz	0.032	0.046	0.057	0.064	0.067	0.074
					RPM	11937	8952	7162	5968	4476	3581
					FEED	1528	1647	1633	1528	1500	1325
	4-5	Non-alloy steel	1.0D	0.8D	Vc	200	205	200	205	205	200
					fz	0.026	0.036	0.046	0.053	0.051	0.056
					RPM	10610	8157	6366	5438	4078	3183
	6	Low alloy steel	1.0D	1.0D	Vc	225	225	225	225	225	225
					fz	0.032	0.046	0.057	0.064	0.067	0.074
					RPM	11937	8952	7162	5968	4476	3581
	7-9	Low alloy steel	1.0D	0.8D	Vc	200	205	200	205	205	200
					fz	0.026	0.036	0.046	0.053	0.051	0.056
RPM					10610	8157	6366	5438	4078	3183	
10	High alloyed steel, and tool steel	1.0D	1.0D	Vc	225	225	225	225	225	225	
				fz	0.032	0.046	0.057	0.064	0.067	0.074	
				RPM	11937	8952	7162	5968	4476	3581	
11.1	High alloyed steel, and tool steel	1.0D	0.8D	Vc	200	205	200	205	205	200	
				fz	0.026	0.036	0.046	0.053	0.051	0.056	
				RPM	10610	8157	6366	5438	4078	3183	
K	15-20	Grey cast iron Nodular cast iron Malleable cast iron	1.0D	1.0D	Vc	225	225	225	225	225	225
					fz	0.032	0.046	0.057	0.064	0.067	0.074
					RPM	11937	8952	7162	5968	4476	3581
					FEED	1528	1647	1633	1528	1500	1325

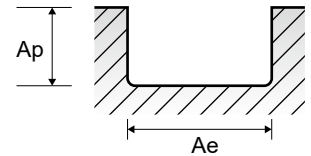

SIDE CUTTING

ISO	VDI 3323	Material Description	Ae	Ap	Parameter	Diameter (Ø)					
						6.0	8.0	10.0	12.0	16.0	20.0
P	1-3	Non-alloy steel	0.5D	1.0D	Vc	300	300	300	300	300	300
					fz	0.041	0.057	0.071	0.08	0.082	0.089
					RPM	15915	11937	9549	7958	5968	4775
					FEED	2610	2722	2712	2546	2447	2125
	4-5	Non-alloy steel	0.35D	1.0D	Vc	270	270	265	270	270	270
					fz	0.032	0.046	0.057	0.065	0.065	0.07
					RPM	14324	10743	8435	7162	5371	4297
	6	Low alloy steel	0.5D	1.0D	Vc	300	300	300	300	300	300
					fz	0.041	0.057	0.071	0.08	0.082	0.089
					RPM	15915	11937	9549	7958	5968	4775
	7-9	Low alloy steel	0.35D	1.0D	Vc	270	270	265	270	270	270
					fz	0.032	0.046	0.057	0.065	0.065	0.07
RPM					14324	10743	8435	7162	5371	4297	
10	High alloyed steel, and tool steel	0.5D	1.0D	Vc	300	300	300	300	300	300	
				fz	0.041	0.057	0.071	0.08	0.082	0.089	
				RPM	15915	11937	9549	7958	5968	4775	
11.1	High alloyed steel, and tool steel	0.35D	1.0D	Vc	270	270	265	270	270	270	
				fz	0.032	0.046	0.057	0.065	0.065	0.07	
				RPM	14324	10743	8435	7162	5371	4297	
K	15-20	Grey cast iron Nodular cast iron Malleable cast iron	0.5D	1.0D	Vc	300	300	300	300	300	300
					fz	0.041	0.057	0.071	0.08	0.082	0.089
					RPM	15915	11937	9549	7958	5968	4775
					FEED	2610	2722	2712	2546	2447	2125

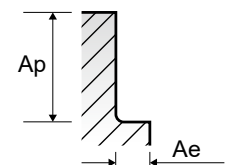

GAE53 SERIES

4&5 FLUTE CORNER RADIUS ROUGHING(HSS-PM) - SIDE CUTTING

Vc = m/min.
fz = mm/tooth
RPM = rev./min.
FEED = mm/min.

ISO	VDI 3323	Material Description	Ae	Ap	Parameter	Diameter (Ø)							
						6.0	8.0	10.0	12.0	14.0	16.0	18.0	20.0
P	1	Non-alloy steel	0.5D	1.5D	Vc	60	70	70	70	70	70	70	70
					fz	0.019	0.027	0.05	0.06	0.055	0.063	0.072	0.08
					RPM	3183	2785	2228	1857	1592	1393	1238	1114
	2		0.5D	1.5D	Vc	48	54	54	54	54	54	54	54
					fz	0.018	0.028	0.049	0.063	0.073	0.081	0.085	0.101
					RPM	2546	2149	1719	1432	1228	1074	955	859
	3-4		0.5D	1.5D	Vc	34	38	38	38	38	38	38	38
					fz	0.017	0.027	0.043	0.059	0.069	0.08	0.086	0.1
					RPM	1804	1512	1210	1008	864	756	672	605
	5		0.5D	1.5D	Vc	28	32	32	32	32	32	32	32
					fz	0.018	0.028	0.041	0.055	0.065	0.075	0.082	0.092
RPM		1485			1273	1019	849	728	637	566	509		
6	0.5D	1.5D	Vc	48	54	54	54	54	54	54	54		
			fz	0.018	0.028	0.049	0.063	0.073	0.081	0.085	0.101		
			RPM	2546	2149	1719	1432	1228	1074	955	859		
7	0.5D	1.5D	Vc	34	38	38	38	38	38	38	38		
			fz	0.017	0.027	0.043	0.059	0.069	0.08	0.086	0.1		
			RPM	1804	1512	1210	1008	864	756	672	605		
8-9	0.5D	1.5D	Vc	28	32	32	32	32	32	32	32		
			fz	0.018	0.028	0.041	0.055	0.065	0.075	0.082	0.092		
			RPM	1485	1273	1019	849	728	637	566	509		
10	0.5D	1.5D	Vc	48	54	54	54	54	54	54	54		
			fz	0.018	0.028	0.049	0.063	0.073	0.081	0.085	0.101		
			RPM	2546	2149	1719	1432	1228	1074	955	859		
11.1	0.5D	1.5D	Vc	28	32	32	32	32	32	32	32		
			fz	0.018	0.028	0.041	0.055	0.065	0.075	0.082	0.092		
			RPM	1485	1273	1019	849	728	637	566	509		
M	14.1	Stainless steel	0.5D	1.5D	Vc	33	36	36	36	36	36	36	36
					fz	0.019	0.029	0.045	0.064	0.074	0.085	0.093	0.107
					RPM	1751	1432	1146	955	819	716	637	573
K	15-20	Grey cast iron Nodular cast iron Malleable cast iron	0.5D	1.5D	Vc	48	54	54	54	54	54	54	54
					fz	0.018	0.028	0.049	0.063	0.073	0.081	0.085	0.101
					RPM	2546	2149	1719	1432	1228	1074	955	859
FEED						183	241	337	361	448	435	406	434

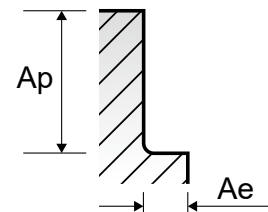



Global Cutting Tool Leader **YG-1**



MILLING



Leading Through Innovation



SOLID CARBIDE

**X-POWER PRO
END MILLS**

X-POWER PRO VHM - FRÄSER

- For Pre-Hardened Steels up to HRc55

- Für vorgehärtete Stähle bis HRc55

SELECTION GUIDE



SERIES	GM876	GM813	GM886	GM902
FLUTE	2	2	2	2
HELIX ANGLE	30°	30°	30°	30°
CUTTING EDGE SHAPE	BALL NOSE	BALL NOSE	BALL NOSE	BALL NOSE
SIZE MIN	R0.5	R0.5	R0.25	R0.5
SIZE MAX	R8.0	R10.0	R3.0	R4.0
PAGE	350	351	352	354

SOLID CARBIDE
X-POWER PRO
END MILLS

for Pre-Hardened Steels up to HRC55,
 Mold & Die, Dry & Wet Cutting

SHORT LENGTH	LONG LENGTH	RIB PROCESSING	TAPER NECK
Y-Coating	Y-Coating	Y-Coating	Y-Coating



Please visit
globalyg1.com/mat
 for material search

◎ : Excellent ○ : Good

Recommended cutting conditions : P 372

ISO	VDI 3323	Material Description	Composition / Structure / Heat Treatment	HB	HRC	GM876	GM813	GM886	GM902	
P	1	Non-alloy steel	About 0.15% C Annealed	125		○	○	○	○	
	2		About 0.45% C Annealed	190	13	○	○	○	○	
	3		About 0.45% C Quenched & Tempered	250	25	○	○	○	○	
	4		About 0.75% C Annealed	270	28	◎	◎	◎	○	
	5		About 0.75% C Quenched & Tempered	300	32	◎	◎	◎	○	
	6	Low alloy steel	Annealed	180	10	○	○	○	○	
	7		Quenched & Tempered	275	29	◎	◎	◎	○	
	8		Quenched & Tempered	300	32	◎	◎	◎	◎	
	9		Quenched & Tempered	350	38	◎	◎	◎	◎	
	10		High alloyed steel, and tool steel	Annealed	200	15	○	○	○	○
	11			Quenched & Tempered	325	35	◎	◎	◎	◎
M	12	Stainless steel	Ferritic / Martensitic Annealed	200	15					
	13		Martensitic Quenched & Tempered	240	23					
	14		Austenitic	180	10					
K	15	Grey cast iron	Pearlitic / ferritic	180	10	○	○	○		
	16		Pearlitic (Martensitic)	260	26	○	○	○		
	17	Nodular cast iron	Ferritic	160	3	○	○	○		
	18		Pearlitic	250	25	○	○	○		
	19		Ferritic	130		○	○	○		
20	Malleable cast iron	Pearlitic	230	21	○	○	○			
N	21	Aluminum-wrought alloy	Not Curable	60						
	22		Curable Hardened	100						
	23	Aluminum-cast, alloyed	≤ 12% Si, Not Curable	75						
	24		≤ 12% Si, Curable Hardened	90						
	25		> 12% Si, Not Curable	130						
	26	Copper and Copper Alloys (Bronze / Brass)	Cutting Alloys, PB>1%	110						
	27		CuZn, CuSnZn (Brass)	90						
	28		CuSn, lead-free copper and electrolytic copper	100						
	29	Non Metallic Materials	Duroplastic, Fiber Reinforced Plastic							
	30		Rubber, Wood, etc.							
S	31	Heat Resistant Super Alloys	Fe Based Annealed	200	15					
	32		Cured	280	30					
	33		Annealed	250	25					
	34		Cured	350	38					
	35	Cast	320	34						
	36	Titanium Alloys	Pure Titanium	400 Rm						
	37		Alpha + Beta Alloys Hardened	1050 Rm						
H	38	Hardened steel	Hardened	550	55	○	○	○	○	
	39		Hardened	630	60	○	○	○	○	
	40	Chilled Cast Iron	Cast	400	42	◎	◎	◎	◎	
	41	Hardened Cast Iron	Hardened	550	55	○	○	○	○	

GM815	GM818	GM8A1	GM839	GM819	GM810	GM883	GM895	GM811	GM817	GM812	GM834	GM814
4	2	2	4	4	2	2	3	4	4	6&8	6	3&4
30°	30°	30°	30°	30°	30°	30°	38°	30°	30°	45°	45°	20°
BALL NOSE	CORNER RADIUS	CORNER RADIUS	CORNER RADIUS	CORNER RADIUS	SQUARE	SQUARE	SQUARE	SQUARE	SQUARE	SQUARE	SQUARE	ROUGHING
R1.0	D4.0	D1.0	D2.0	D3.0	D0.4	D0.4	D1.0	D2.0	D2.0	D6.0	D6.0	D6.0
R8.0	D12.0	D6.0	D12.0	D20.0	D20.0	D6.0	D16.0	D25.0	D20.0	D20.0	D25.0	D20.0
355	356	357	359	360	361	363	366	367	368	369	370	371
LONG LENGTH	LONG LENGTH	RIB PROCESSING	STUB LENGTH	LONG LENGTH	SHORT LENGTH	RIB PROCESSING	SHORT LENGTH	SHORT LENGTH	LONG LENGTH	LONG LENGTH	EXTRA LONG LENGTH	LONG LENGTH
Y-Coating	Y-Coating	Y-Coating	Y-Coating	Y-Coating	Y-Coating	Y-Coating	Y-Coating	Y-Coating	Y-Coating	Y-Coating	Y-Coating	Y-Coating

○	○	○	○	○	○	○	○	○	○	○	○	○
○	○	○	○	○	○	○	○	○	○	○	○	○
○	○	○	○	○	○	○	○	○	○	○	○	○
◎	◎	◎	◎	◎	◎	◎	◎	◎	◎	◎	◎	◎
◎	◎	◎	◎	◎	◎	◎	◎	◎	◎	◎	◎	◎
○	○	○	○	○	○	○	○	○	○	○	○	○
◎	◎	◎	◎	◎	◎	◎	◎	◎	◎	◎	◎	◎
◎	◎	◎	◎	◎	◎	◎	◎	◎	◎	◎	◎	◎
○	○	○	○	○	○	○	○	○	○	○	○	○
◎	◎	◎	◎	◎	◎	◎	◎	◎	◎	◎	◎	◎
				○	○	○	○	○	○	○	○	○
				○	○	○	○	○	○	○	○	○
				○	○	○	○	○	○	○	○	○
○	○	○	○	○	○	○	○	○	○	○	○	○
○	○	○	○	○	○	○	○	○	○	○	○	○
○	○	○	○	○	○	○	○	○	○	○	○	○
○	○	○	○	○	○	○	○	○	○	○	○	○
○	○	○	○	○	○	○	○	○	○	○	○	○
○	○	○	○	○	○	○	○	○	○	○	○	○
○	○	○	○	○	○	○	○	○	○	○	○	○
◎	◎	◎	◎	◎	◎	◎	◎	◎	◎	◎	◎	◎
○	○	○	○	○	○	○	○	○	○	○	○	○

HSS

CBN END MILLS

i-Xmill END MILLS

i-SMART MODULAR END MILLS

X5070 END MILLS

4G MILL END MILLS

X-POWER PRO END MILLS

TitaNox-POWER END MILLS

JET-POWER END MILLS

V7 PLUS END MILLS

ALU-POWER HPC END MILLS

ALU-POWER END MILLS

D-POWER GRAPHITE END MILLS

D-POWER CFRP END MILLS

ROUTERS

CRX S END MILLS

K-2 END MILLS

ONLY ONE COATED PM60 END MILLS

TANK-POWER END MILLS

GENERAL HSS END MILLS

MILLING CUTTERS

TECHNICAL DATA

CARBIDE, 2 FLUTE SHORT LENGTH BALL NOSE

- **VOLLHARTMETALL, 2 SCHNEIDEN KURZ KUGELSTIRN**
- **Fraise carbure, 2 dents, hémisphérique, courte**
- **2 TAGLIENTI, SEMISFERICA, SERIE CORTA**

- ▶ Economic type with short overall length.
- ▶ Radius tolerance $\pm 0.02\text{mm}$ & short length of cut.

- ▶ **Günstige Variante, kurze Gesamlänge.**
- ▶ **Radius Toleranz $\pm 0.02\text{mm}$ und kurze Schneidenlänge.**

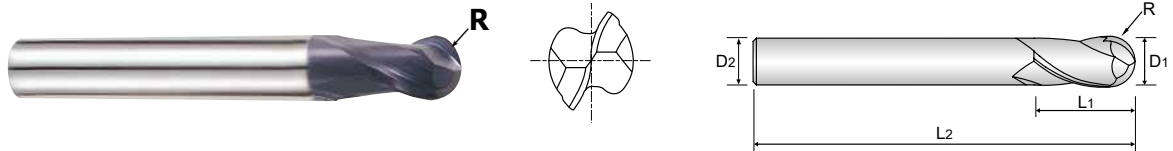

CARBIDE
2
30°
R ± 0.02
PLAIN
P.372-373

Unit : mm

EDP No.	Radius of Ball Nose	Mill Diameter	Shank Diameter	Length of Cut	Overall Length
	R(± 0.02)	D1	D2	L1	L2
GM876010	R0.5	1.0	3	3	38
GM876020	R1.0	2.0	6	3	50
GM876030	R1.5	3.0	6	4	50
GM876040	R2.0	4.0	6	5	54
GM876060	R3.0	6.0	6	7	54
GM876080	R4.0	8.0	8	9	58
GM876100	R5.0	10.0	10	11	66
GM876120	R6.0	12.0	12	12	73
GM876160	R8.0	16.0	16	16	82

Mill Dia. Tolerance (mm)	Shank Dia. Tolerance
0 ~ - 0.03	h5

◎ : Excellent ○ : Good

ISO Material Description	P											M			K						
	Non-alloy steel					Low alloy steel				High alloyed steel, and tool steel		Stainless steel			Grey cast iron		Nodular cast iron		Malleable cast iron		
VDI 3323	1	2	3	4	5	6	7	8	9	10	11	12	13	14	15	16	17	18	19	20	
HRc	13	19	25	28	32	10	29	32	38	15	35	15	23	10	10	26	3	25		21	
HB	125	190	250	270	300	180	275	300	350	200	325	200	240	180	180	260	160	250	130	230	
Recommend	○	○	○	◎	◎	○	◎	◎	◎	○	◎				○	○	○	○	○	○	
ISO Material Description	N										S							H			
	Aluminum-wrought alloy		Aluminum-cast, alloyed			Copper and Copper Alloys (Bronze / Brass)			Non Metallic Materials		Heat Resistant Super Alloys					Titanium Alloys		Hardened steel	Chilled Cast Iron	Hardened Cast Iron	
VDI 3323	21	22	23	24	25	26	27	28	29	30	31	32	33	34	35	36	37	38	39	40	41
HRc											15	30	25	38	34			55	60	42	55
HB	60	100	75	90	130	110	90	100			200	280	250	350	320	400 Rm	1050 Rm	550	630	400	550
Recommend																		○	○	◎	○

CARBIDE, 2 FLUTE LONG LENGTH BALL NOSE

- VOLLHARTMETALL, 2 SCHNEIDEN LANG KUGELSTIRN
- Fraise carbure, 2 dents, hémisphérique, longue
- 2 TAGLIANTI, SEMISFERICA, SERIE LUNGA

- ▶ Designed to machine tool steel, alloy steel, mold steel and other high hardened materials.
- ▶ For copy - milling machines.

- ▶ Zur Bearbeitung von Werkzeugstählen, Legierten Stählen, Stahlguß und gehärteten Stählen.
- ▶ Für Kopierfräsmaschinen.

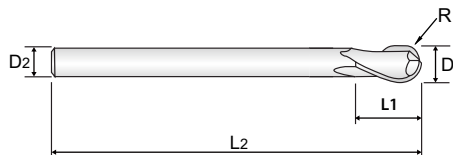
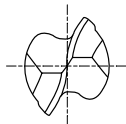

CARBIDE
2
30°
R ±0.02
PLAIN
P.372-373

Unit : mm

EDP No.	Radius of Ball Nose	Mill Diameter	Shank Diameter	Length of Cut	Overall Length
	R(±0.02)	D1	D2	L1	L2
GM813010	R0.5	1.0	4	2.5	50
GM813020	R1.0	2.0	6	5	50
GM813030	R1.5	3.0	6	8	60
GM813040	R2.0	4.0	6	8	70
GM813050	R2.5	5.0	6	10	80
GM813060	R3.0	6.0	6	12	90
GM813080	R4.0	8.0	8	14	100
GM813100	R5.0	10.0	10	18	100
GM813120	R6.0	12.0	12	22	110
GM813160	R8.0	16.0	16	30	140
GM813200	R10.0	20.0	20	38	160

Mill Dia. Tolerance (mm)	Shank Dia. Tolerance
0 ~ -0.03	h5

◎ : Excellent ○ : Good

ISO Material Description	P											M			K							
	Non-alloy steel					Low alloy steel						High alloyed steel, and tool steel			Stainless steel			Grey cast iron		Nodular cast iron		Malleable cast iron
VDI 3323	1	2	3	4	5	6	7	8	9	10	11	12	13	14	15	16	17	18	19	20		
HRc	125	130	135	140	145	150	155	160	165	170	175	180	185	190	200	210	220	230	240	250		
HB	125	190	250	270	300	180	275	300	350	200	325	200	240	180	180	260	160	250	130	230		
Recommend	○	○	○	◎	◎	○	◎	◎	◎	○	◎	○	○	○	○	○	○	○	○	○		

ISO Material Description	N										S						H				
	Aluminum-wrought alloy		Aluminum-cast, alloyed			Copper and Copper Alloys (Bronze / Brass)			Non Metallic Materials		Heat Resistant Super Alloys						Titanium Alloys		Hardened steel	Chilled Cast Iron	Hardened Cast Iron
VDI 3323	21	22	23	24	25	26	27	28	29	30	31	32	33	34	35	36	37	38	39	40	41
HRc	60	100	75	90	130	110	90	100			15	30	25	38	34	400 Rm	1050 Rm	550	630	400	550
HB	60	100	75	90	130	110	90	100			200	280	250	350	320	400 Rm	1050 Rm	550	630	400	550
Recommend																		○	◎	○	○

CARBIDE, 2 FLUTE BALL NOSE for RIB PROCESSING

- **VOLLHARTMETALL, 2 SCHNEIDEN KUGELSTIRN für SCHMALE RIPPEN**
- **Fraise carbure, 2 dents, hémisphérique pour usinage de rainure**
- **2 TAGLIENTI, SEMISFERICA PER NERVATURE**

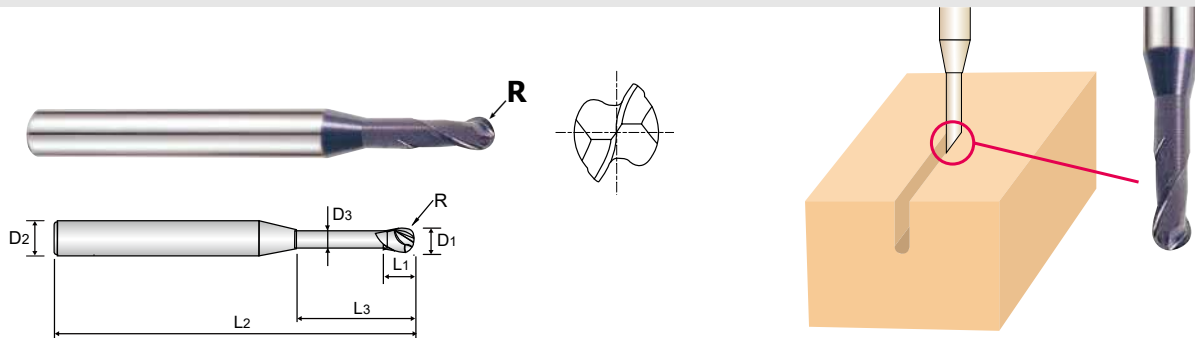

CARBIDE
2
30°
R ±0.01
PLAIN
P.374-375

Unit : mm

EDP No.	Radius of Ball Nose	Mill Diameter	Shank Diameter	Length of Cut	Length Below Shank	Overall Length	Neck Diameter
	R(±0.01)	D1	D2	L1	L3	L2	D3
GM886005	R0.25	0.5	4	0.7	2	45	0.45
GM886962	R0.25	0.5	4	0.7	4	45	0.45
GM886957	R0.3	0.6	4	0.9	2	45	0.55
GM886915	R0.3	0.6	4	0.9	4	45	0.55
GM886916	R0.3	0.6	4	0.9	6	45	0.55
GM886919	R0.4	0.8	4	1.2	4	45	0.75
GM886008	R0.4	0.8	4	1.2	6	45	0.75
GM886921	R0.5	1.0	4	1.5	4	45	0.95
GM886923	R0.5	1.0	4	1.5	5	45	0.95
GM886010	R0.5	1.0	4	1.5	6	45	0.95
GM886902	R0.5	1.0	4	1.5	8	45	0.95
GM886903	R0.5	1.0	4	1.5	10	45	0.95
GM886904	R0.5	1.0	4	1.5	12	45	0.95
GM886927	R0.5	1.0	4	1.5	16	50	0.95
GM886012	R0.6	1.2	4	1.8	8	45	1.15
GM886930	R0.75	1.5	4	2.3	6	45	1.45
GM886015	R0.75	1.5	4	2.3	8	45	1.45
GM886931	R0.75	1.5	4	2.3	10	45	1.45
GM886906	R0.75	1.5	4	2.3	12	45	1.45
GM886940	R1.0	2.0	4	3	6	45	1.95
GM886020	R1.0	2.0	4	3	8	45	1.95
GM886941	R1.0	2.0	4	3	10	45	1.95
GM886942	R1.0	2.0	4	3	12	50	1.95
GM886909	R1.0	2.0	4	3	16	50	1.95

▶ NEXT PAGE

Mill Dia. Tolerance (mm)	Shank Dia. Tolerance
0 ~ - 0.02	h5

◎ : Excellent ○ : Good

ISO Material Description	P											M				K				
	Non-alloy steel					Low alloy steel				High alloyed steel, and tool steel		Stainless steel				Grey cast iron		Nodular cast iron		Malleable cast iron
VDI 3323	1	2	3	4	5	6	7	8	9	10	11	12	13	14	15	16	17	18	19	20
HRc		13	25	28	32	10	29	32	38	15	35	15	23	10	10	26	3	25		21
HB	125	190	250	270	300	180	275	300	350	200	325	200	240	180	180	260	160	250	130	230
Recommend	○	○	○	◎	◎	○	◎	◎	◎	○	◎				○	○	○	○	○	○

ISO Material Description	N										S							H			
	Aluminum-wrought alloy		Aluminum-cast, alloyed			Copper and Copper Alloys (Bronze / Brass)			Non Metallic Materials		Heat Resistant Super Alloys					Titanium Alloys		Hardened steel	Chilled Cast Iron	Hardened Cast Iron	
VDI 3323	21	22	23	24	25	26	27	28	29	30	31	32	33	34	35	36	37	38	39	40	41
HRc											15	30	25	38	34			55	60	42	55
HB	60	100	75	90	130	110	90	100			200	280	250	350	320	400 Rm	1050 Rm	550	630	400	550
Recommend																		○	◎	◎	○

CARBIDE, 2 FLUTE BALL NOSE for RIB PROCESSING

- VOLLHARTMETALL, 2 SCHNEIDEN KUGELSTIRN für SCHMALE RIPPEN
- Fraise carbure, 2 dents, hémisphérique pour usinage de rainure
- 2 TAGLIANTI, SEMISFERICA PER NERVATURE

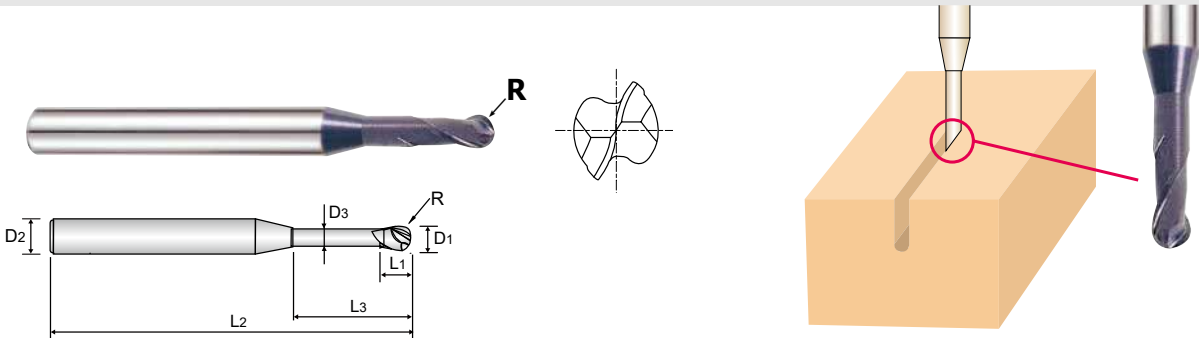

CARBIDE 2 30° ±0.01 PLAIN P.374-375

Unit : mm

EDP No.	Radius of Ball Nose	Mill Diameter	Shank Diameter	Length of Cut	Length Below Shank	Overall Length	Neck Diameter
	R(±0.01)	D1	D2	L1	L3	L2	D3
GM886910	R1.0	2.0	4	3	20	55	1.95
GM886945	R1.0	2.0	4	3	25	60	1.95
GM886967	R1.0	2.0	4	3	30	70	1.95
GM886947	R1.5	3.0	6	4.5	10	50	2.85
GM886948	R1.5	3.0	6	4.5	12	50	2.85
GM886030	R1.5	3.0	6	4.5	16	55	2.85
GM886911	R1.5	3.0	6	4.5	20	60	2.85
GM886968	R1.5	3.0	6	4.5	25	65	2.85
GM886040	R2.0	4.0	6	6	16	60	3.85
GM886912	R2.0	4.0	6	6	20	65	3.85
GM886913	R2.0	4.0	6	6	25	70	3.85
GM886971	R2.0	4.0	6	6	30	70	3.85
GM886972	R2.0	4.0	6	6	35	80	3.85
GM886050	R2.5	5.0	6	7.5	16	60	4.85
GM886060	R3.0	6.0	6	9	20	80	5.85
GM886954	R3.0	6.0	6	9	30	90	5.85

Mill Dia. Tolerance (mm)	Shank Dia. Tolerance
0 ~ -0.02	h5

◎ : Excellent ○ : Good

ISO Material Description	P											M				K								
	Non-alloy steel					Low alloy steel						High alloyed steel, and tool steel				Stainless steel				Grey cast iron		Nodular cast iron		Malleable cast iron
VDI 3323	1	2	3	4	5	6	7	8	9	10	11	12	13	14	15	16	17	18	19	20				
HRC	125	130	190	250	270	180	275	300	350	200	325	200	240	180	180	260	160	250	130	230				
Recommend	○	○	○	○	◎	○	◎	◎	◎	○	◎	○	○	○	○	○	○	○	○	○				
ISO Material Description	N										S						H							
	Aluminum-wrought alloy		Aluminum-cast, alloyed			Copper and Copper Alloys (Bronze / Brass)			Non Metallic Materials		Heat Resistant Super Alloys						Titanium Alloys		Hardened steel	Chilled Cast Iron	Hardened Cast Iron			
VDI 3323	21	22	23	24	25	26	27	28	29	30	31	32	33	34	35	36	37	38	39	40	41			
HRC	60	100	75	90	130	110	90	100			200	280	250	350	320	400 Rm	1050 Rm	550	630	400	550			
Recommend																		○	◎	○	○			

CARBIDE
HSS
CBN END MILLS
i-Xmill END MILLS
i-SMART MODULAR END MILLS
X5070 END MILLS
4G MILL END MILLS
X-POWER PRO END MILLS
TitaNox-POWER END MILLS
JET-POWER END MILLS
V7 PLUS END MILLS
ALU-POWER HPC END MILLS
ALU-POWER END MILLS
D-POWER GRAPHITE END MILLS
D-POWER CFRP END MILLS
ROUTERS
CRX S END MILLS
K-2 END MILLS
ONLY ONE COATED PM60 END MILLS
TANK-POWER END MILLS
GENERAL HSS END MILLS
MILLING CUTTERS
TECHNICAL DATA

CARBIDE, 2 FLUTE BALL NOSE with TAPER NECK

- **VOLLHARTMETALL, 2 SCHNEIDEN KUGELSTIRN mit KONISCH ABGESETZTEM SCHAFTTEIL**
- **Fraise carbure, 2 dents, hémisphérique avec entrée conique**
- **2 TAGLIENTI, SEMISFERICA, SCARICO CONICO**

▶ High efficiency milling in deep slotting due to long projection of the end mills.

▶ Effizientes Tiefnutenfräsen von tiefliegenden Bereichen möglich.

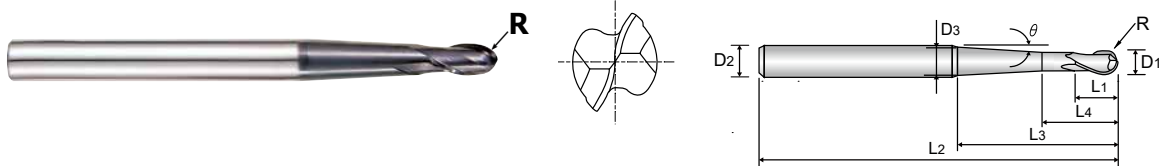

CARBIDE 2 30° ±0.01 PLAIN P.376-377

Unit : mm

EDP No.	Radius of Ball Nose	Mill Diameter	Shank Diameter	Length of Cut	Under Neck Parallel Length	Length Below Shank	Overall Length	Neck Diameter	Taper Neck Angle
	R(±0.01)	D1	D2	L1	L4	L3	L2	D3	θ
GM902010	R0.5	1.0	6	2	4	23	60	2	1° 30'
GM902901	R0.5	1.0	6	2	4	23	60	4.3	5°
GM902902	R0.5	1.0	6	2	4	42	80	5	3°
GM902020	R1.0	2.0	6	4	6	23	60	2.9	1° 30'
GM902903	R1.0	2.0	6	4	6	23	60	5	5°
GM902904	R1.0	2.0	6	4	6	41	80	5.7	3°
GM902030	R1.5	3.0	6	6	8	32	70	5.6	3°
GM902905	R1.5	3.0	6	6	8	52	90	5.3	1° 30'
GM902040	R2.0	4.0	6	8	10	28	70	5.9	3°
GM902906	R2.0	4.0	6	8	10	49	90	6	1° 30'
GM902060	R3.0	6.0	8	12	15	34	90	8	3°
GM902908	R3.0	6.0	8	12	15	53	110	8	1° 30'
GM902080	R4.0	8.0	10	14	17	36	100	10	3°
GM902909	R4.0	8.0	10	14	17	55	120	10	1° 30'

Mill Dia. Tolerance (mm)	Shank Dia. Tolerance
0 ~ - 0.03	h5

◎ : Excellent ○ : Good

ISO Material Description	P											M			K						
	Non-alloy steel					Low alloy steel				High alloyed steel, and tool steel		Stainless steel			Grey cast iron		Nodular cast iron	Malleable cast iron			
VDI 3323	1	2	3	4	5	6	7	8	9	10	11	12	13	14	15	16	17	18	19	20	
HRc		13	25	28	32	10	29	32	38	15	35	15	23	10	10	26	3	25		21	
HB	125	190	250	270	300	180	275	300	350	200	325	200	240	180	180	260	160	250	130	230	
Recommend	○	○	○	○	○	○	○	○	◎	○	◎										
ISO Material Description	N										S							H			
	Aluminum-wrought alloy		Aluminum-cast, alloyed			Copper and Copper Alloys (Bronze / Brass)			Non Metallic Materials		Heat Resistant Super Alloys					Titanium Alloys		Hardened steel	Chilled Cast Iron	Hardened Cast Iron	
VDI 3323	21	22	23	24	25	26	27	28	29	30	31	32	33	34	35	36	37	38	39	40	41
HRc											15	30	25	38	34			55	60	42	55
HB	60	100	75	90	130	110	90	100			200	280	250	350	320	400 Rm	1050 Rm	550	630	400	550
Recommend																		○		◎	○

CARBIDE, 4 FLUTE LONG LENGTH BALL NOSE

- VOLLHARTMETALL, 4 SCHNEIDEN LANG KUGELSTIRN
- Fraise carbure, 4 dents, hémisphérique, longue
- 4 TAGLIANTI, SEMISFERICA, SERIE LUNGA

- ▶ Designed to machine tool steels, alloy steels, mold steels and other high hardened materials.
- ▶ For copy - milling machines.
- ▶ 4 Flute design - higher feed than GM813 series

- ▶ Zur Bearbeitung von Werkzeugstählen, Legierten Stählen, Stahlguß und gehärteten Stählen.
- ▶ Für Kopierfräsmaschinen.
- ▶ 4 Schneiden - Höherer Vorschub als bei GM813 serien.

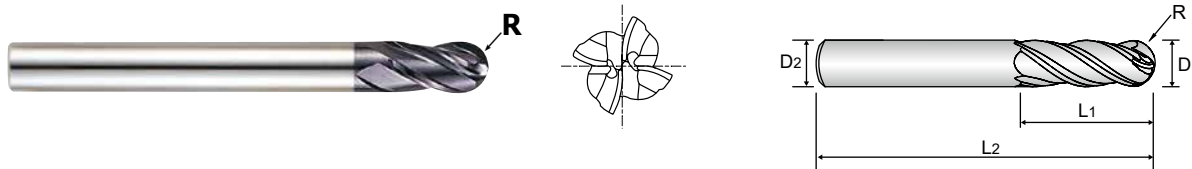

Unit : mm

EDP No.	Radius of Ball Nose	Mill Diameter	Shank Diameter	Length of Cut	Overall Length
	R(±0.02)	D1	D2	L1	L2
GM815020	R1.0	2.0	6	5	50
GM815030	R1.5	3.0	6	8	60
GM815040	R2.0	4.0	6	8	70
GM815050	R2.5	5.0	6	10	80
GM815060	R3.0	6.0	6	12	90
GM815080	R4.0	8.0	8	14	100
GM815100	R5.0	10.0	10	18	100
GM815120	R6.0	12.0	12	22	110
GM815160	R8.0	16.0	16	30	140

Mill Dia. Tolerance (mm)	Shank Dia. Tolerance
0 ~ - 0.03	h5

◎ : Excellent ○ : Good

ISO Material Description	P										M					K						
	Non-alloy steel					Low alloy steel					High alloyed steel, and tool steel					Stainless steel			Grey cast iron		Nodular cast iron	
VDI 3323	1	2	3	4	5	6	7	8	9	10	11	12	13	14	15	16	17	18	19	20		
HRC	13	25	28	32	10	29	32	38	15	35	15	23	10	15	26	3	25	130	230			
HB	125	190	250	270	300	180	275	300	350	200	325	200	240	180	180	260	160	250	130	230		
Recommend	○	○	○	◎	◎	○	◎	◎	◎	○	◎	○	○	○	○	○	○	○	○	○		
ISO Material Description	N										S						H					
VDI 3323	Aluminum-wrought alloy		Aluminum-cast, alloyed			Copper and Copper Alloys (Bronze / Brass)			Non Metallic Materials		Heat Resistant Super Alloys						Titanium Alloys		Hardened steel	Chilled Cast Iron	Hardened Cast Iron	
	21	22	23	24	25	26	27	28	29	30	31	32	33	34	35	36	37	38	39	40	41	
HRC	60	100	75	90	130	110	90	100			15	30	25	38	34	400 Rm	1050 Rm	55	60	42	55	
HB	60	100	75	90	130	110	90	100			200	280	250	350	320	400 Rm	1050 Rm	550	630	400	550	
Recommend											○	○	○	○	○	○	○	○	○	◎	○	

CARBIDE, 2 FLUTE LONG LENGTH CORNER RADIUS

- **VOLLHARTMETALL, 2 SCHNEIDEN LANG ECKENRADIUS**
- **Fraise carbure, 2 dents, torique, longue**
- **2 TAGLIENTI, TORICA, SERIE LUNGA**

- ▶ Designed to machine tool steels, alloy steels, mold steels and other hardened materials.
- ▶ Superior workpiece finishes.
- ▶ Increased feed rates.

- ▶ Zur Bearbeitung von Werkzeugstählen, Legierten Stählen, Stahlguß und gehärteten Stählen.
- ▶ Bessere Werkstückoberflächen.
- ▶ Höhere Vorschubwerte.

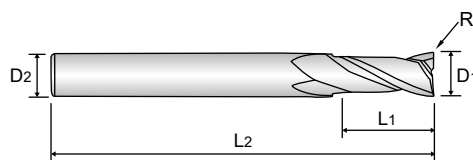
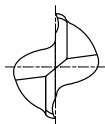

Unit : mm

EDP No.	Corner Radius	Mill Diameter	Shank Diameter	Length of Cut	Overall Length
	R	D1	D2	L1	L2
GM818911	R0.5	4.0	6	15	50
GM818060	R0.5	6.0	6	20	60
GM818901	R1.0	6.0	6	20	60
GM818080	R0.5	8.0	8	25	70
GM818902	R1.0	8.0	8	25	70
GM818100	R0.5	10.0	10	30	90
GM818905	R1.0	10.0	10	30	90
GM818908	R1.0	12.0	12	30	90

Mill Dia. Tolerance (mm)	Shank Dia. Tolerance
0 ~ - 0.03	h5

◎ : Excellent ○ : Good

ISO Material Description	P											M			K						
	Non-alloy steel					Low alloy steel				High alloyed steel, and tool steel		Stainless steel			Grey cast iron		Nodular cast iron		Malleable cast iron		
VDI 3323	1	2	3	4	5	6	7	8	9	10	11	12	13	14	15	16	17	18	19	20	
HRc		13	25	28	32	10	29	32	38	15	35	15	23	10	10	26	3	25		21	
HB	125	190	250	270	300	180	275	300	350	200	325	200	240	180	180	260	160	250	130	230	
Recommend	○	○	○	◎	◎	○	◎	◎	◎	○	◎				○	○	○	○	○	○	
ISO Material Description	N										S							H			
	Aluminum-wrought alloy		Aluminum-cast, alloyed			Copper and Copper Alloys (Bronze / Brass)			Non Metallic Materials		Heat Resistant Super Alloys					Titanium Alloys		Hardened steel	Chilled Cast Iron	Hardened Cast Iron	
VDI 3323	21	22	23	24	25	26	27	28	29	30	31	32	33	34	35	36	37	38	39	40	41
HRc											15	30	25	38	34			55	60	42	55
HB	60	100	75	90	130	110	90	100			200	280	250	350	320	400 Rm	1050 Rm	550	630	400	550
Recommend																		○		◎	○



X-POWER PRO END MILLS

PLAIN SHANK

GM8A1 SERIES

CARBIDE, 2 FLUTE CORNER RADIUS for RIB PROCESSING

- VOLLHARTMETALL, 2 SCHNEIDEN ECKENRADIUS für SCHMALE RIPPEN
- Fraise carbure, 2 dents, torique pour usinage de rainure
- 2 TAGLIANTI, TORICA PER NERVATURE

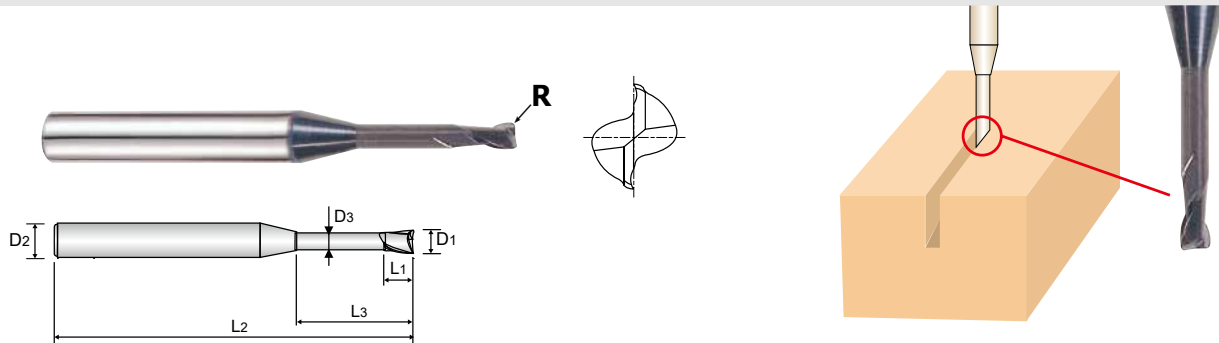

Unit : mm

EDP No.	Corner Radius	Mill Diameter	Shank Diameter	Length of Cut	Length Below Shank	Overall Length	Neck Diameter
	R	D1	D2	L1	L3	L2	D3
GM8A1010	R0.1	1.0	4	1.5	6	45	0.95
GM8A1920	R0.1	1.0	4	1.5	8	45	0.95
GM8A1921	R0.1	1.0	4	1.5	10	45	0.95
GM8A1012	R0.2	1.2	4	1.8	6	45	1.15
GM8A1015	R0.2	1.5	4	2.3	6	45	1.45
GM8A1937	R0.2	1.5	4	2.3	8	45	1.45
GM8A1938	R0.2	1.5	4	2.3	10	45	1.45
GM8A1939	R0.2	1.5	4	2.3	12	45	1.45
GM8A1941	R0.2	1.5	4	2.3	16	50	1.45
GM8A1018	R0.2	1.8	4	2.7	6	45	1.75
GM8A1960	R0.2	2.0	4	3	6	45	1.95
GM8A1020	R0.2	2.0	4	3	8	45	1.95
GM8A1962	R0.2	2.0	4	3	12	45	1.95
GM8A1961	R0.2	2.0	4	3	10	45	1.95
GM8A1964	R0.2	2.0	4	3	16	50	1.95
GM8A1966	R0.2	2.0	4	3	20	55	1.95
GM8A1967	R0.2	2.0	4	3	25	60	1.95
GM8A1969	R0.2	2.5	4	3.7	12	45	2.40

Mill Dia. Tolerance (mm)	Shank Dia. Tolerance
0 ~ - 0.03	h5

▶ NEXT PAGE

◎ : Excellent ○ : Good

ISO Material Description	P										M				K						
	Non-alloy steel					Low alloy steel					High alloyed steel, and tool steel				Stainless steel		Grey cast iron		Nodular cast iron		Malleable cast iron
VDI 3323	1	2	3	4	5	6	7	8	9	10	11	12	13	14	15	16	17	18	19	20	
HRc	13	25	28	32	10	29	32	38	15	35	15	23	10	10	26	3	25	130	21		
HB	125	190	250	270	300	180	275	300	350	200	325	200	240	180	260	160	250	130	230		
Recommend	○	○	○	○	◎	○	◎	◎	◎	○	◎	○	○	○	○	○	○	○	○	○	
ISO Material Description	N								S								H				
	Aluminum- wrought alloy		Aluminum-cast, alloyed			Copper and Copper Alloys (Bronze / Brass)			Non Metallic Materials	Heat Resistant Super Alloys				Titanium Alloys		Hardened steel	Chilled Cast Iron	Hardened Cast Iron			
VDI 3323	21	22	23	24	25	26	27	28	29	30	31	32	33	34	35	36	37	38	39	40	41
HRc											15	30	25	38	34			55	60	42	55
HB	60	100	75	90	130	110	90	100			200	280	250	350	320	400 Rm	1050 Rm	550	630	400	550
Recommend																		○	○	◎	○

CARBIDE, 2 FLUTE CORNER RADIUS for RIB PROCESSING

- **VOLLHARTMETALL, 2 SCHNEIDEN ECKENRADIUS für SCHMALE RIPPEN**
- **Fraise carbure, 2 dents, torique pour usinage de rainure**
- **2 TAGLIENTI, TORICA PER NERVATURE**

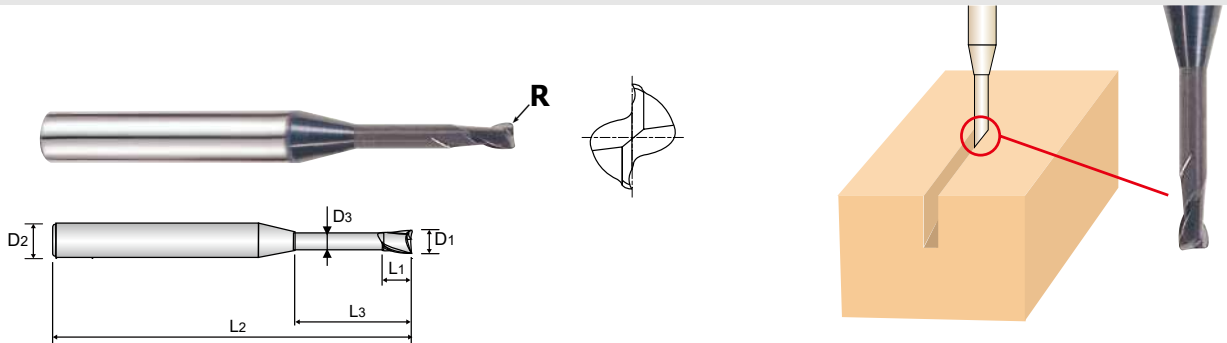

CARBIDE
2
30°
PLAIN
P.381-382

Unit : mm

EDP No.	Corner Radius	Mill Diameter	Shank Diameter	Length of Cut	Length Below Shank	Overall Length	Neck Diameter
	R	D1	D2	L1	L3	L2	D3
GM8A1981	R0.3	3.0	6	4.5	16	55	2.85
GM8A1983	R0.3	3.0	6	4.5	20	60	2.85
GM8A1984	R0.3	3.0	6	4.5	25	65	2.85
GM8A1976	R0.3	3.0	6	4.5	30	70	2.85
GM8A1985	R0.3	3.0	6	4.5	40	90	2.85
GM8A1040	R0.3	4.0	6	6	12	50	3.85
GM8A1986	R0.3	4.0	6	6	16	60	3.85
GM8A1987	R0.3	4.0	6	6	20	60	3.85
GM8A1060	R0.5	6.0	6	9	20	80	5.85
GM8A1802	R0.5	6.0	6	9	40	100	5.85

Mill Dia. Tolerance (mm)	Shank Dia. Tolerance
0 ~ -0.03	h5

◎ : Excellent ○ : Good

ISO Material Description	P											M				K					
	Non-alloy steel					Low alloy steel				High alloyed steel, and tool steel		Stainless steel				Grey cast iron		Nodular cast iron		Malleable cast iron	
VDI 3323	1	2	3	4	5	6	7	8	9	10	11	12	13	14	15	16	17	18	19	20	
HRc		13	25	28	32	10	29	32	38	15	35	15	23	10	10	26	3	25		21	
HB	125	190	250	270	300	180	275	300	350	200	325	200	240	180	180	260	160	250	130	230	
Recommend	○	○	○	◎	◎	○	◎	◎	◎	○	◎				○	○	○	○	○	○	
ISO Material Description	N										S							H			
	Aluminum-wrought alloy		Aluminum-cast, alloyed			Copper and Copper Alloys (Bronze / Brass)			Non Metallic Materials		Heat Resistant Super Alloys					Titanium Alloys		Hardened steel	Chilled Cast Iron	Hardened Cast Iron	
VDI 3323	21	22	23	24	25	26	27	28	29	30	31	32	33	34	35	36	37	38	39	40	41
HRc											15	30	25	38	34			55	60	42	55
HB	60	100	75	90	130	110	90	100			200	280	250	350	320	400 Rm	1050 Rm	550	630	400	550
Recommend																		○	◎	◎	○



CARBIDE, 4 FLUTE STUB LENGTH CORNER RADIUS

- VOLLHARTMETALL, 4 SCHNEIDEN EXTRA KURZ ECKENRADIUS
- Fraise carbure, 4 dents, torique, extra-courte
- 4 TAGLIANTI, TORICA, TAGLIENTE CORTO, SCARICATA

- ▶ Designed to machine tool steels, alloy steels, mold steels and other hardened materials.
- ▶ Superior workpiece finishes.
- ▶ Increased feed rates.

- ▶ Zur Bearbeitung von Werkzeugstählen, Legierten Stählen, Stahlguß und gehärteten Stählen.
- ▶ Bessere Werkstückoberflächen.
- ▶ Höhere Vorschubwerte.

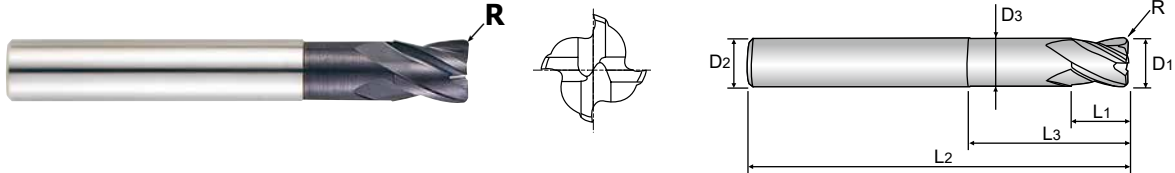

Unit : mm

EDP No.	Corner Radius	Mill Diameter	Shank Diameter	Length of Cut	Length Below Shank	Overall Length	Neck Diameter
	R	D1	D2	L1	L3	L2	D3
GM839020	R0.2	2.0	6	2.5	5	50	1.9
GM839030	R0.3	3.0	6	4	7	50	2.8
GM839040	R0.4	4.0	6	5	9	50	3.7
GM839060	R0.6	6.0	6	7	14	55	5.6
GM839080	R0.8	8.0	8	10	18	60	7.4
GM839100	R1.0	10.0	10	12	25	70	9.4
GM839120	R1.2	12.0	12	15	30	80	11.4

Mill Dia. Tolerance (mm)	Shank Dia. Tolerance
0 ~ -0.03	h5

◎ : Excellent ○ : Good

ISO Material Description	P										M				K						
	Non-alloy steel					Low alloy steel					High alloyed steel, and tool steel		Stainless steel		Grey cast iron		Nodular cast iron		Malleable cast iron		
VDI 3323	1	2	3	4	5	6	7	8	9	10	11	12	13	14	15	16	17	18	19	20	
HRc																					
HB	125	190	250	270	300	180	275	300	350	200	325	200	240	180	180	260	160	250	130	230	
Recommend	○	○	○	◎	◎	○	◎	◎	◎	○	◎	○	○	○	○	○	○	○	○	○	
ISO Material Description	N										S						H				
	Aluminum-wrought alloy		Aluminum-cast, alloyed			Copper and Copper Alloys (Bronze / Brass)			Non Metallic Materials		Heat Resistant Super Alloys				Titanium Alloys		Hardened steel	Chilled Cast Iron	Hardened Cast Iron		
VDI 3323	21	22	23	24	25	26	27	28	29	30	31	32	33	34	35	36	37	38	39	40	41
HRc																					
HB	60	100	75	90	130	110	90	100			200	280	250	350	320	400 Rm	1050 Rm	550	630	400	550
Recommend																		○	◎	○	○

CARBIDE, 4 FLUTE LONG LENGTH CORNER RADIUS

- **VOLLHARTMETALL, 4 SCHNEIDEN LANG ECKENRADIUS**
- **Fraise carbure, 4 dents, torique, longue**
- **4 TAGLIENTI, TORICA, SERIE LUNGA**

- ▶ Designed to machine tool steels, alloy steels, mold steels and other hardened materials.
- ▶ 4 flute allows for better workpiece finishes.
- ▶ Increased production.

- ▶ Zur Bearbeitung von Werkzeugstählen, Legierten Stählen, Stahlguß und gehärteten Stählen.
- ▶ 4 Schneiden für bessere Oberflächengüte des Werkstücks.
- ▶ Gesteigerte Productivität.

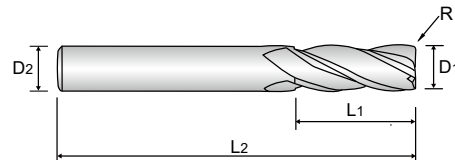
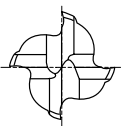

CARBIDE 4 30° PLAIN P.384

Unit : mm

EDP No.	Corner Radius	Mill Diameter	Shank Diameter	Length of Cut	Overall Length
	R	D1	D2	L1	L2
GM819030	R0.3	3.0	6	12	50
GM819040	R0.3	4.0	6	15	50
GM819911	R0.5	4.0	6	15	50
GM819912	R0.5	5.0	6	20	60
GM819060	R0.5	6.0	6	20	60
GM819901	R1.0	6.0	6	20	60
GM819080	R0.5	8.0	8	25	70
GM819902	R1.0	8.0	8	25	70
GM819904	R2.0	8.0	8	25	70
GM819100	R0.5	10.0	10	30	90
GM819905	R1.0	10.0	10	30	90
GM819906	R1.5	10.0	10	30	90
GM819907	R2.0	10.0	10	30	90
GM819120	R0.5	12.0	12	30	90
GM819908	R1.0	12.0	12	30	90
GM819909	R1.5	12.0	12	30	90
GM819910	R2.0	12.0	12	30	90
GM819160	R0.5	16.0	16	50	110
GM819916	R1.0	16.0	16	50	110
GM819918	R2.0	16.0	16	50	110
GM819921	R2.0	20.0	20	55	110

Mill Dia. Tolerance (mm)	Shank Dia. Tolerance
0 ~ - 0.03	h5

◎ : Excellent ○ : Good

ISO Material Description	P										M					K									
	Non-alloy steel					Low alloy steel					High alloyed steel, and tool steel					Stainless steel					Grey cast iron		Nodular cast iron		Malleable cast iron
VDI 3323	1	2	3	4	5	6	7	8	9	10	11	12	13	14	15	16	17	18	19	20	21	22			
HRc	13	25	28	32	10	29	32	38	15	35	10	23	10	10	26	3	3	25	21						
HB	125	190	250	270	300	180	275	300	350	200	325	200	240	180	180	260	160	250	130	230					
Recommend	○	○	○	◎	◎	○	◎	◎	◎	○	◎	○	○	○	○	○	○	○	○	○	○	○			

ISO Material Description	N										S							H			
	Aluminum-wrought alloy		Aluminum-cast, alloyed			Copper and Copper Alloys (Bronze / Brass)		Non Metallic Materials			Heat Resistant Super Alloys					Titanium Alloys		Hardened steel	Chilled Cast Iron	Hardened Cast Iron	
VDI 3323	21	22	23	24	25	26	27	28	29	30	31	32	33	34	35	36	37	38	39	40	41
HRc											15	30	25	38	34			55	60	42	55
HB	60	100	75	90	130	110	90	100			200	280	250	350	320	400 Rm	1050 Rm	550	630	400	550
Recommend																		○	◎	◎	○

CARBIDE, 2 FLUTE MINIATURE

- VOLLHARTMETALL, 2 SCHNEIDEN MINI
- Fraise carbure, 2 dents, micro-fraise
- 2 TAGLIANTI, MINI

- ▶ High precision milling in medical, optical, electronics and aerospace industries.
- ▶ Excellent performance on hardened steel

- ▶ Hochpräzises Fräsen für Medizintechnik, Optik, Elektronik und Raumfahrt.
- ▶ Ausgezeichnete Leistung bei der Bearbeitung von gehärtetem Stahl.

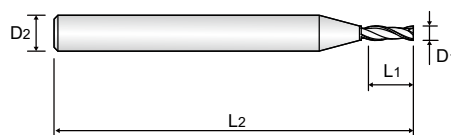
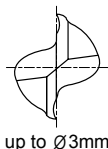

CARBIDE 2 30° PLAIN P.385

Unit : mm

EDP No.	Mill Diameter	Shank Diameter	Length of Cut	Overall Length
	D1	D2	L1	L2
GM810004	0.4	3	0.8	40
GM810005	0.5	3	1	40
GM810006	0.6	3	1.2	40
GM810007	0.7	3	1.4	40
GM810008	0.8	3	1.6	40
GM810009	0.9	3	2	40
GM810010	1.0	4	2.5	40
GM810901	1.0	6	2.5	40
GM810012	1.2	4	4	40
GM810014	1.4	4	4	40
GM810015	1.5	4	4	40

▶ NEXT PAGE

Mill Dia. Tolerance (mm)	Shank Dia. Tolerance
0 ~ - 0.03	h5

◎ : Excellent ○ : Good

ISO Material Description	P										M				K						
	Non-alloy steel					Low alloy steel					High alloyed steel, and tool steel				Stainless steel		Grey cast iron		Nodular cast iron		Malleable cast iron
VDI 3323	1	2	3	4	5	6	7	8	9	10	11	12	13	14	15	16	17	18	19	20	
HRC	13	25	28	32	10	29	32	38	15	35	15	23	10	10	26	3	25	130	21		
HB	125	190	250	270	300	180	275	300	350	200	325	200	240	180	180	260	160	250	130	230	
Recommend	○	○	○	◎	◎	○	◎	◎	◎	◎	◎	○	○	○	○	○	○	○	○	○	
ISO Material Description	N					S										H					
	Aluminum-wrought alloy		Aluminum-cast, alloyed			Copper and Copper Alloys (Bronze / Brass)			Non Metallic Materials		Heat Resistant Super Alloys					Titanium Alloys		Hardened steel	Chilled Cast Iron	Hardened Cast Iron	
VDI 3323	21	22	23	24	25	26	27	28	29	30	31	32	33	34	35	36	37	38	39	40	41
HRC	60	100	75	90	130	110	90	100			15	30	25	38	34	400 Rm	1050 Rm	55	60	42	55
HB	60	100	75	90	130	110	90	100			200	280	250	350	320	400 Rm	1050 Rm	550	630	400	550
Recommend																		○	◎	◎	○

CARBIDE, 2 FLUTE SHORT LENGTH

● **VOLLHARTMETALL, 2 SCHNEIDEN KURZ**

● **Fraise carbure, 2 dents, courte**

● **2 TAGLIENTI, SERIE CORTA**

- ▶ Designed to machine tool steels, alloy steels, mold steels and other hardened materials.
- ▶ Superior workpiece finishes.
- ▶ Increased feed rates.

- ▶ Zur Bearbeitung: Werkzeugstählen, Legierten Stählen, Stahlguß und gehärteten Stählen.
- ▶ Bessere Werkstückoberflächen.
- ▶ Höhere Vorschübe.

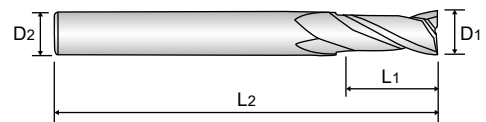
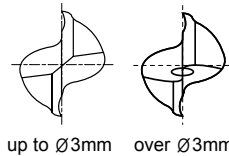

Unit : mm

EDP No.	Mill Diameter	Shank Diameter	Length of Cut	Overall Length
	D1	D2	L1	L2
GM810901	1.0	6	2.5	40
GM810902	1.5	6	4	40
GM810020	2.0	4	6	40
GM810903	2.0	6	6	40
GM810025	2.5	4	8	40
GM810030	3.0	6	8	45
GM810035	3.5	6	10	45
GM810040	4.0	6	11	45
GM810050	5.0	6	13	50
GM810060	6.0	6	13	50
GM810070	7.0	8	16	60
GM810080	8.0	8	19	60
GM810090	9.0	10	19	70
GM810100	10.0	10	22	70
GM810110	11.0	12	22	75
GM810120	12.0	12	26	75
GM810140	14.0	14	26	85
GM810160	16.0	16	32	100
GM810180	18.0	18	32	100
GM810200	20.0	20	38	105

Mill Dia. Tolerance (mm)	Shank Dia. Tolerance
0 ~ - 0.03	h5

◎ : Excellent ○ : Good

ISO Material Description	P											M				K					
	Non-alloy steel					Low alloy steel				High alloyed steel, and tool steel		Stainless steel				Grey cast iron		Nodular cast iron		Malleable cast iron	
VDI 3323	1	2	3	4	5	6	7	8	9	10	11	12	13	14	15	16	17	18	19	20	
HRc		13	25	28	32	10	29	32	38	15	35	15	23	10	10	26	3	25		21	
HB	125	190	250	270	300	180	275	300	350	200	325	200	240	180	180	260	160	250	130	230	
Recommend	○	○	○	◎	◎	○	◎	◎	◎	○	◎	○	○	○	○	○	○	○	○	○	
ISO Material Description	N										S							H			
	Aluminum-wrought alloy		Aluminum-cast, alloyed			Copper and Copper Alloys (Bronze / Brass)			Non Metallic Materials		Heat Resistant Super Alloys					Titanium Alloys		Hardened steel	Chilled Cast Iron	Hardened Cast Iron	
VDI 3323	21	22	23	24	25	26	27	28	29	30	31	32	33	34	35	36	37	38	39	40	41
HRc											15	30	25	38	34			55	60	42	55
HB	60	100	75	90	130	110	90	100			200	280	250	350	320	400 Rm	1050 Rm	550	630	400	550
Recommend																		○	◎	◎	○



X-POWER PRO END MILLS

PLAIN SHANK

GM883 SERIES

CARBIDE, 2 FLUTE for RIB PROCESSING

- VOLLHARTMETALL, 2 SCHNEIDEN für SCHMALE RIPPEN
- Fraise carbure, 2 dents pour usinage de rainure
- 2 TAGLIANTI, SCARICATA PER NERVATURE

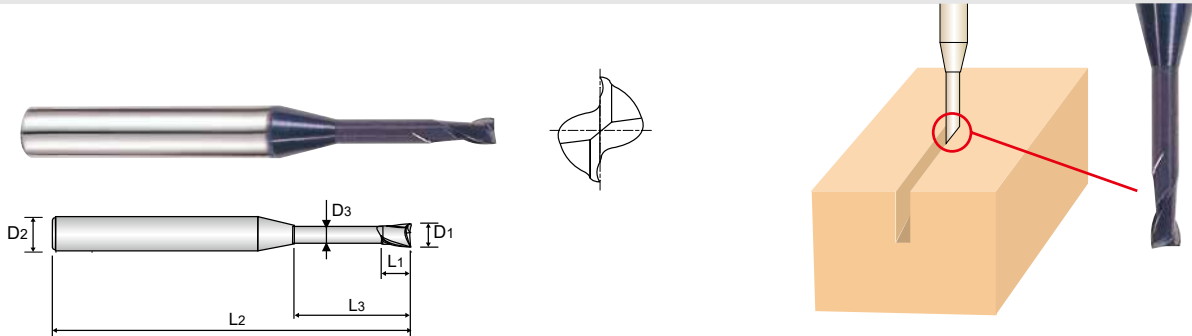

CARBIDE
2
30°
PLAIN
P.386-387

Unit : mm

EDP No.	Mill Diameter	Shank Diameter	Length of Cut	Length Below Shank	Overall Length	Neck Diameter
	D1	D2	L1	L3	L2	D3
GM883004	0.4	4	0.6	2	45	0.37
GM883005	0.5	4	0.7	2	45	0.45
GM883988	0.5	4	0.7	4	45	0.45
GM883820	0.7	4	1	3	45	0.65
GM883008	0.8	4	1.2	4	45	0.75
GM883908	0.8	4	1.2	6	45	0.75
GM883996	1.0	4	1.5	4	45	0.95
GM883010	1.0	4	1.5	6	45	0.95
GM883912	1.0	4	1.5	8	45	0.95
GM883913	1.0	4	1.5	10	45	0.95
GM883914	1.0	4	1.5	12	45	0.95
GM883997	1.0	4	1.5	16	50	0.95
GM883998	1.0	4	1.5	20	55	0.95
GM883012	1.2	4	1.8	6	45	1.15
GM883015	1.5	4	2.3	6	45	1.45
GM883923	1.5	4	2.3	8	45	1.45
GM883924	1.5	4	2.3	10	45	1.45
GM883925	1.5	4	2.3	12	45	1.45
GM883927	1.5	4	2.3	16	50	1.45
GM883810	1.5	4	2.3	20	55	1.45

▶ NEXT PAGE

Mill Dia. Tolerance (mm)	Shank Dia. Tolerance
0 ~ - 0.015	h5

◎ : Excellent ○ : Good

ISO Material Description	P										M				K							
	Non-alloy steel					Low alloy steel					High alloyed steel, and tool steel				Stainless steel			Grey cast iron		Nodular cast iron		Malleable cast iron
VDI 3323	1	2	3	4	5	6	7	8	9	10	11	12	13	14	15	16	17	18	19	20		
HRc	13	25	28	32	10	29	32	38	15	35	15	23	10	15	26	3	25	130	230			
HB	125	190	250	270	300	180	275	300	350	200	325	200	240	180	180	260	160	250	130	230		
Recommend	○	○	○	◎	◎	○	◎	◎	◎	○	◎	○	○	○	○	○	○	○	○	○		
ISO Material Description	N									S						H						
	Aluminum-wrought alloy		Aluminum-cast, alloyed			Copper and Copper Alloys (Bronze / Brass)				Non Metallic Materials		Heat Resistant Super Alloys				Titanium Alloys		Hardened steel	Chilled Cast Iron	Hardened Cast Iron		
VDI 3323	21	22	23	24	25	26	27	28	29	30	31	32	33	34	35	36	37	38	39	40	41	
HRc	60	100	75	90	130	110	90	100			15	30	25	38	34	55	60	42	55	400	550	
HB	60	100	75	90	130	110	90	100			200	280	250	350	320	400 Rm	1050 Rm	550	630	400	550	
Recommend	○	○	○	○	○	○	○	○	○	○	○	○	○	○	○	○	○	○	○	○	○	

YG X-POWER PRO END MILLS

PLAIN SHANK

GM883 SERIES

CARBIDE, 2 FLUTE for RIB PROCESSING

- **VOLLHARTMETALL, 2 SCHNEIDEN für SCHMALE RIPPEN**
- **Fraise carbure, 2 dents pour usinage de rainure**
- **2 TAGLIENTI, SCARICATA PER NERVATURE**

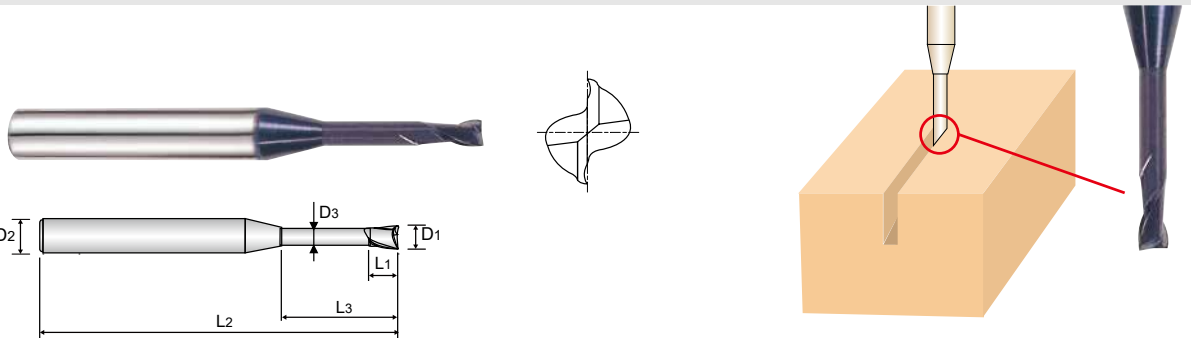

CARBIDE 2 30° PLAIN P.386-387

Unit : mm

EDP No.	Mill Diameter	Shank Diameter	Length of Cut	Length Below Shank	Overall Length	Neck Diameter
	D1	D2	L1	L3	L2	D3
GM883946	1.8	4	2.7	12	45	1.75
GM883958	2.0	4	3	6	45	1.95
GM883020	2.0	4	3	8	45	1.95
GM883959	2.0	4	3	10	45	1.95
GM883960	2.0	4	3	12	45	1.95
GM883961	2.0	4	3	14	50	1.95
GM883962	2.0	4	3	16	50	1.95
GM883964	2.0	4	3	20	55	1.95
GM883966	2.0	4	3	25	60	1.95
GM883814	2.0	4	3	30	70	1.95
GM883970	2.5	4	3.7	16	55	2.40
GM883975	3.0	6	4.5	10	45	2.85
GM883976	3.0	6	4.5	12	45	2.85
GM883978	3.0	6	4.5	16	55	2.85
GM883979	3.0	6	4.5	18	55	2.85
GM883980	3.0	6	4.5	20	60	2.85
GM883981	3.0	6	4.5	25	65	2.85
GM883832	3.0	6	4.5	30	70	2.85
GM883983	3.0	6	4.5	40	90	2.85

▶ NEXT PAGE

Mill Dia. Tolerance (mm)	Shank Dia. Tolerance
0 ~ -0.015	h5

◎ : Excellent ○ : Good

ISO Material Description	P					M					K																																	
	Non-alloy steel					Low alloy steel					High alloyed steel, and tool steel					Stainless steel					Grey cast iron		Nodular cast iron		Malleable cast iron																			
VDI 3323	1	2	3	4	5	6	7	8	9	10	11	12	13	14	15	16	17	18	19	20	21	22	23	24	25	26	27	28	29	30	31	32	33	34	35	36	37	38	39	40	41			
HRc	125	190	250	270	300	180	275	300	350	200	325	200	240	180	180	260	160	250	130	230																								
Recommend	○	○	○	○	◎	○	◎	◎	◎	○	◎	○	◎	◎	○	◎	○	◎	○	◎	○	◎	○	◎	○	◎	○	◎	○	◎	○	◎	○	◎	○	◎	○	◎	○	◎	○	◎		
ISO Material Description	N					S					H																																	
	Aluminum-wrought alloy		Aluminum-cast, alloyed			Copper and Copper Alloys (Bronze / Brass)			Non Metallic Materials		Heat Resistant Super Alloys					Titanium Alloys		Hardened steel		Chilled Cast Iron		Hardened Cast Iron																						
VDI 3323	21	22	23	24	25	26	27	28	29	30	31	32	33	34	35	36	37	38	39	40	41	42	43	44	45	46	47	48	49	50	51	52	53	54	55	56	57	58	59	60				
HRc	60	100	75	90	130	110	90	100			200	280	250	350	320	400 Rm	1050 Rm	550	630	400	550	42	55	55	60	60	630	400	550	550	630	400	550	550	630	400	550	550	630	400	550			
Recommend	○	◎	○	◎	◎	○	◎	◎	◎	◎	○	◎	◎	◎	◎	○	◎	○	◎	○	◎	○	◎	○	◎	○	◎	○	◎	○	◎	○	◎	○	◎	○	◎	○	◎	○	◎	○	◎	

CARBIDE, 2 FLUTE for RIB PROCESSING

- VOLLHARTMETALL, 2 SCHNEIDEN für SCHMALE RIPPEN
- Fraise carbure, 2 dents pour usinage de rainure
- 2 TAGLIENTI, SCARICATA PER NERVATURE



CARBIDE
2
30°
PLAIN
P.386-387

Unit : mm

EDP No.	Mill Diameter	Shank Diameter	Length of Cut	Length Below Shank	Overall Length	Neck Diameter
	D1	D2	L1	L3	L2	D3
GM883801	4.0	6	6	16	60	3.85
GM883802	4.0	6	6	20	60	3.85
GM883803	4.0	6	6	25	70	3.85
GM883834	4.0	6	6	30	70	3.85
GM883836	4.0	6	6	40	90	3.85
GM883838	4.0	6	6	50	100	3.85
GM883807	6.0	6	9	30	90	5.85
GM883809	6.0	6	9	50	110	5.85

Mill Dia. Tolerance (mm)	Shank Dia. Tolerance
0 ~ -0.015	h5

◎ : Excellent ○ : Good

ISO Material Description	P											M			K					
	Non-alloy steel					Low alloy steel				High alloyed steel, and tool steel		Stainless steel			Grey cast iron		Nodular cast iron		Malleable cast iron	
VDI 3323	1	2	3	4	5	6	7	8	9	10	11	12	13	14	15	16	17	18	19	20
HRC	125	13	25	28	32	10	29	32	38	15	35	15	23	10	10	26	3	25	130	230
HB	125	190	250	270	300	180	275	300	350	200	325	200	240	180	180	260	160	250	130	230
Recommend	○	○	○	◎	◎	○	◎	◎	◎	○	◎				○	○	○	○	○	○

ISO Material Description	N					S										H					
	Aluminum-wrought alloy		Aluminum-cast, alloyed		Copper and Copper Alloys (Bronze / Brass)	Non Metallic Materials	Heat Resistant Super Alloys					Titanium Alloys		Hardened steel	Chilled Cast Iron	Hardened Cast Iron					
VDI 3323	21	22	23	24	25	26	27	28	29	30	31	32	33	34	35	36	37	38	39	40	41
HRC	60	100	75	90	130	110	90	100			15	30	25	38	34	400 Rm	1050 Rm	550	630	400	550
HB	60	100	75	90	130	110	90	100			200	280	250	350	320	400 Rm	1050 Rm	550	630	400	550
Recommend																		○	◎	◎	○

CARBIDE, 3 FLUTE 38° HELIX SHORT LENGTH

● **VOLLHARTMETALL, 3 SCHNEIDEN 38° RECHTSSPIRALE KURZ**
● **Fraise carbure, 3 dents, hélice 38°, courte**
● **3 TAGLIENTI, ELICA 38°, SERIE CORTA**

- ▶ Designed to machine tool steels, alloy steels, mold steels and other hardened materials.
- ▶ Possesses the advantage of 2 flute and 4 flute end mill.
- ▶ Superior workpiece finishes.

- ▶ Zur Bearbeitung: Werkzeugstählen, Legierten Stählen, Stahlguß und gehärteten Stählen.
- ▶ Besitzt die Vorteile von 2 und 4 Schneiden Fräsern
- ▶ Bessere Werkstückoberflächen

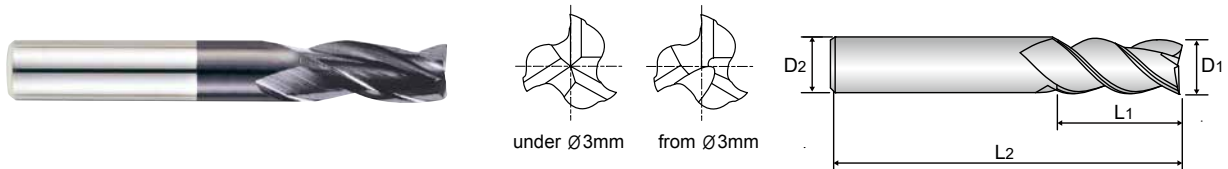

CARBIDE
3
38°
PLAIN
P.388-389

Unit : mm

EDP No.	Mill Diameter	Shank Diameter	Length of Cut	Overall Length
	D1	D2	L1	L2
GM895010	1.0	3	2.5	38
GM895015	1.5	4	5	50
GM895025	2.5	3	7	38
GM895030	3.0	3	10	38
GM895901	3.0	6	10	50
GM895040	4.0	4	12	50
GM895903	4.0	6	12	50
GM895050	5.0	5	14	50
GM895904	5.0	6	14	57
GM895060	6.0	6	16	57
GM895080	8.0	8	20	63
GM895100	10.0	10	22	72
GM895120	12.0	12	25	73
GM895160	16.0	16	32	82

Mill Dia. Tolerance (mm)	Shank Dia. Tolerance
0 ~ - 0.03	h5

◎ : Excellent ○ : Good

ISO Material Description	P											M				K					
	Non-alloy steel					Low alloy steel				High alloyed steel, and tool steel		Stainless steel		Grey cast iron		Nodular cast iron		Malleable cast iron			
VDI 3323	1	2	3	4	5	6	7	8	9	10	11	12	13	14	15	16	17	18	19	20	
HRc		13	25	28	32	10	29	32	38	15	35	15	23	10	10	26	3	25		21	
HB	125	190	250	270	300	180	275	300	350	200	325	200	240	180	180	260	160	250	130	230	
Recommend	○	○	○	◎	◎	○	◎	◎	◎	○	◎	○	○	○	○	○	○	○	○	○	
ISO Material Description	N										S							H			
	Aluminum-wrought alloy		Aluminum-cast, alloyed			Copper and Copper Alloys (Bronze / Brass)			Non Metallic Materials		Heat Resistant Super Alloys					Titanium Alloys		Hardened steel	Chilled Cast Iron	Hardened Cast Iron	
VDI 3323	21	22	23	24	25	26	27	28	29	30	31	32	33	34	35	36	37	38	39	40	41
HRc											15	30	25	38	34			55	60	42	55
HB	60	100	75	90	130	110	90	100			200	280	250	350	320	400 Rm	1050 Rm	550	630	400	550
Recommend																		○		◎	○

CARBIDE, 4 FLUTE SHORT LENGTH

- **VOLLHARTMETALL, 4 SCHNEIDEN KURZ**
- (●) **Fraise carbure, 4 dents, courte**
- (●) **4 TAGLIENTI, SERIE CORTA**

- ▶ Designed to machine tool steels, alloy steels, mold steels and other hardened materials.
- ▶ 4 flute allows for better workpiece finishes.
- ▶ Increased Productivity.

- ▶ Zur Bearbeitung: Werkzeugstählen, Legierten Stählen, Stahlguß und gehärteten Stählen.
- ▶ 4 Schneiden erzeugen eine bessere Oberfläche des Werkstücks.
- ▶ Höhere Produktivität.

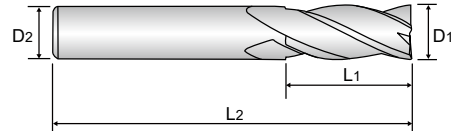
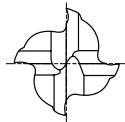

Unit : mm

EDP No.	Mill Diameter	Shank Diameter	Length of Cut	Overall Length
	D1	D2	L1	L2
GM811020	2.0	4	6	40
GM811901	2.0	6	6	40
GM811025	2.5	4	8	40
GM811902	2.5	6	8	40
GM811030	3.0	6	8	45
GM811035	3.5	6	10	45
GM811040	4.0	6	11	45
GM811045	4.5	6	11	45
GM811050	5.0	6	13	50
GM811060	6.0	6	13	50
GM811080	8.0	8	19	60
GM811100	10.0	10	22	70
GM811120	12.0	12	26	75
GM811140	14.0	14	26	85
GM811160	16.0	16	32	100
GM811200	20.0	20	38	105
GM811250	25.0	25	45	120

Mill Dia. Tolerance (mm)	Shank Dia. Tolerance
0 ~ - 0.03	h5

◎ : Excellent ○ : Good

ISO Material Description	P										M				K						
	Non-alloy steel					Low alloy steel					High alloyed steel, and tool steel				Stainless steel		Grey cast iron		Nodular cast iron		Malleable cast iron
VDI 3323	1	2	3	4	5	6	7	8	9	10	11	12	13	14	15	16	17	18	19	20	
HRc																					
HB	125	190	250	270	300	180	275	300	350	200	325	200	240	180	180	260	160	250	130	230	
Recommend	○	○	○	◎	◎	○	◎	◎	◎	○	◎	○	○	○	○	○	○	○	○	○	
ISO Material Description	N										S						H				
	Aluminum-wrought alloy		Aluminum-cast, alloyed			Copper and Copper Alloys (Bronze / Brass)			Non Metallic Materials		Heat Resistant Super Alloys						Titanium Alloys		Hardened steel	Chilled Cast Iron	Hardened Cast Iron
VDI 3323	21	22	23	24	25	26	27	28	29	30	31	32	33	34	35	36	37	38	39	40	41
HRc																					
HB	60	100	75	90	130	110	90	100			200	280	250	350	320	400 Rm	1050 Rm	550	630	400	550
Recommend																		○	◎	○	○

CARBIDE, 4 FLUTE LONG LENGTH

- **VOLLHARTMETALL, 4 SCHNEIDEN LANG**
- **Fraise carbure, 4 dents, longue**
- **4 TAGLIENTI, SERIE LUNGA**

- ▶ Designed to machine tool steels, alloy steels, mold steels and other hardened materials.
- ▶ 4 flute allows for better workpiece finishes.
- ▶ Increased Productivity.

- ▶ **Zur Bearbeitung: Werkzeugstählen, Legierten Stählen, Stahlguß und gehärteten Stählen.**
- ▶ **4 Schneiden erzeugen eine bessere Oberfläche des Werkstücks.**
- ▶ **Höhere Produktivität.**

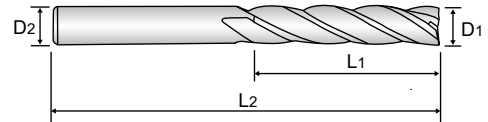
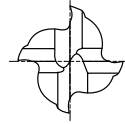

CARBIDE 4 30° PLAIN P.391

Unit : mm

EDP No.	Mill Diameter	Shank Diameter	Length of Cut	Overall Length
	D1	D2	L1	L2
GM817020	2.0	4	8	40
GM817030	3.0	6	12	50
GM817040	4.0	6	15	50
GM817050	5.0	6	20	60
GM817060	6.0	6	20	60
GM817080	8.0	8	25	70
GM817100	10.0	10	30	90
GM817120	12.0	12	30	90
GM817140	14.0	16	40	110
GM817160	16.0	16	50	110
GM817200	20.0	20	55	110

Mill Dia. Tolerance (mm)	Shank Dia. Tolerance
0 ~ - 0.03	h5

◎ : Excellent ○ : Good

ISO Material Description	P											M			K						
	Non-alloy steel					Low alloy steel				High alloyed steel, and tool steel		Stainless steel			Grey cast iron		Nodular cast iron		Malleable cast iron		
VDI 3323	1	2	3	4	5	6	7	8	9	10	11	12	13	14	15	16	17	18	19	20	
HRc		13	25	28	32	10	29	32	38	15	35	15	23	10	10	26	3	25		21	
HB	125	190	250	270	300	180	275	300	350	200	325	200	240	180	180	260	160	250	130	230	
Recommend	○	○	○	◎	◎	○	◎	◎	◎	○	◎				○	○	○	○	○	○	
ISO Material Description	N										S							H			
	Aluminum-wrought alloy		Aluminum-cast, alloyed			Copper and Copper Alloys (Bronze / Brass)			Non Metallic Materials		Heat Resistant Super Alloys					Titanium Alloys		Hardened steel	Chilled Cast Iron	Hardened Cast Iron	
VDI 3323	21	22	23	24	25	26	27	28	29	30	31	32	33	34	35	36	37	38	39	40	41
HRc											15	30	25	38	34			55	60	42	55
HB	60	100	75	90	130	110	90	100			200	280	250	350	320	400 Rm	1050 Rm	550	630	400	550
Recommend																		○		◎	○

CARBIDE, 6&8 FLUTE 45° HELIX LONG LENGTH

- VOLLHARTMETALL, 6&8 SCHNEIDEN 45° RECHTSSPIRALE LANG
- Fraise carbure, 6&8 dents, hélice 45°, longue
- 6&8 TAGLIANTI, ELICA 45°, SERIE

- ▶ Designed to machine hardened materials.
- ▶ High speed cutting and finish milling with high feed rates.
- ▶ Superior workpiece finishes.
- ▶ Superior wear resistance.
- ▶ Suitable for dry milling.

- ▶ Geeignet zum Fräsen von gehärteten Stählen.
- ▶ Hochgeschwindigkeitsfräsen und Finishing mit erhöhtem Vorschub.
- ▶ Bessere Werkstückoberflächen
- ▶ Höhere Verschleißfestigkeit.
- ▶ Geeignet zum Trocken-Fräsen.

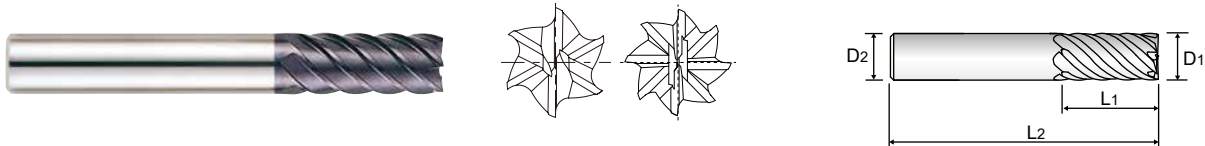

Unit : mm

EDP No.	Mill Diameter	Shank Diameter	Length of Cut	Overall Length	No. of Flute
	D1	D2	L1	L2	
GM812060	6.0	6	13	57	6
GM812080	8.0	8	19	63	6
GM812100	10.0	10	22	72	6
GM812120	12.0	12	26	83	6
GM812160	16.0	16	32	92	6
GM812200	20.0	20	38	104	8

Mill Dia. Tolerance (mm)	Shank Dia. Tolerance
0 ~ - 0.03	h5

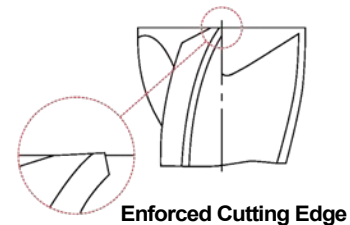

◎ : Excellent ○ : Good

ISO	P										M			K							
	Non-alloy steel					Low alloy steel					High alloyed steel, and tool steel			Stainless steel			Grey cast iron		Nodular cast iron		Malleable cast iron
Material Description	1	2	3	4	5	6	7	8	9	10	11	12	13	14	15	16	17	18	19	20	
VDI 3323	1	2	3	4	5	6	7	8	9	10	11	12	13	14	15	16	17	18	19	20	
HRC	13	13	25	28	32	10	29	32	38	15	35	15	23	10	10	26	3	25	42	21	
HB	125	190	250	270	300	180	275	300	350	200	325	200	240	180	180	260	160	250	130	230	
Recommend	○	○	○	◎	◎	○	◎	◎	◎	○	◎				○	○	○	○	○	○	

ISO	N					S										H					
	Aluminum-wrought alloy		Aluminum-cast, alloyed			Copper and Copper Alloys (Bronze / Brass)			Non Metallic Materials		Heat Resistant Super Alloys					Titanium Alloys		Hardened steel	Chilled Cast Iron	Hardened Cast Iron	
Material Description	21	22	23	24	25	26	27	28	29	30	31	32	33	34	35	36	37	38	39	40	41
VDI 3323	21	22	23	24	25	26	27	28	29	30	31	32	33	34	35	36	37	38	39	40	41
HRC	60	100	75	90	130	110	90	100			15	30	25	38	34	400 Rm	1050 Rm	550	630	400	550
HB	60	100	75	90	130	110	90	100			200	280	250	350	320	400 Rm	1050 Rm	550	630	400	550
Recommend																		○	◎	◎	○

CARBIDE, 6 FLUTE 45° HELIX EXTRA LONG LENGTH

- **VOLLHARTMETALL, 6 SCHNEIDEN 45° RECHTSSPIRALE EXTRA LANG**
- **Fraise carbure, 6 dents, hélice 45°, extra-longue**
- **6 TAGLIENTI, ELICA 45°, SERIE EXTRA LUNGA**

- ▶ Designed to machine hardened materials.
- ▶ High speed cutting and finish milling with high feed rates.
- ▶ Superior workpiece finishes.
- ▶ Superior wear resistance.
- ▶ Suitable for dry milling.

- ▶ Geeignet zum Fräsen von gehärteten Stählen.
- ▶ Hochgeschwindigkeitsfräsen und Finishing mit erhöhtem Vorschub.
- ▶ Bessere Werkstückoberflächen
- ▶ Höhere Verschleißfestigkeit.
- ▶ Geeignet zum Trocken-Fräsen.

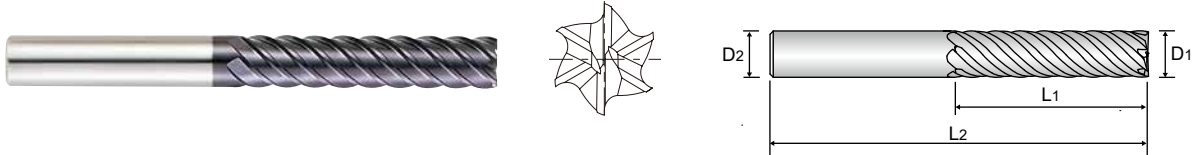

Unit : mm

EDP No.	Mill Diameter	Shank Diameter	Length of Cut	Overall Length
	D1	D2	L1	L2
GM834060	6.0	6	26	70
GM834080	8.0	8	36	90
GM834100	10.0	10	46	100
GM834120	12.0	12	56	110
GM834160	16.0	16	66	130
GM834200	20.0	20	76	140
GM834250	25.0	25	92	180

Mill Dia. Tolerance (mm)	Shank Dia. Tolerance
0 ~ - 0.03	h5

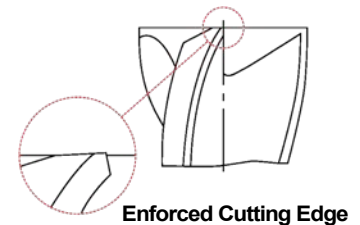

◎ : Excellent ○ : Good

ISO Material Description	P											M			K					
	Non-alloy steel					Low alloy steel				High alloyed steel, and tool steel		Stainless steel			Grey cast iron		Nodular cast iron		Malleable cast iron	
VDI 3323	1	2	3	4	5	6	7	8	9	10	11	12	13	14	15	16	17	18	19	20
HRc		13	25	28	32	10	29	32	38	15	35	15	23	10	10	26	3	25		21
HB	125	190	250	270	300	180	275	300	350	200	325	200	240	180	180	260	160	250	130	230
Recommend	○	○	○	◎	◎	○	◎	◎	◎	○	◎				○	○	○	○	○	○

ISO Material Description	N										S							H			
	Aluminum-wrought alloy		Aluminum-cast, alloyed			Copper and Copper Alloys (Bronze / Brass)		Non Metallic Materials			Heat Resistant Super Alloys					Titanium Alloys		Hardened steel	Chilled Cast Iron	Hardened Cast Iron	
VDI 3323	21	22	23	24	25	26	27	28	29	30	31	32	33	34	35	36	37	38	39	40	41
HRc											15	30	25	38	34			55	60	42	55
HB	60	100	75	90	130	110	90	100			200	280	250	350	320	400 Rm	1050 Rm	550	630	400	550
Recommend																		○		◎	○

CARBIDE, 3&4 FLUTE 20° HELIX LONG LENGTH ROUGHING - FINE
 ● VOLLHARTMETALL, 3&4 SCHNEIDEN 20° RECHTSSPIRALE LANG SCHRUPPFRÄSER - FEIN
 () Fraise carbure, 3&4-dents ébauche, hélice 20°, pas fin, longue
 () 3 - 4 TAGLIANTI, BOMBATO FINE PER SGROSSATURA, ELICA 20° SERIE LUNGA

- ▶ Designed to machine tool steels, alloy steels, mold steels and other hardened materials.
- ▶ High velocity milling of hardened steels.
- ▶ For dry and wet milling.
- ▶ Fast chip ejection.

- ▶ Zur Bearbeitung von Werkzeugstählen, Legierten Stählen, Stahlguß und gehärteten Stählen.
- ▶ Hochgeschwindigkeitsfräsen von gehärteten Stählen.
- ▶ Für Trocken- und Nassfräsen.
- ▶ Schnelle Spanabfuhr.

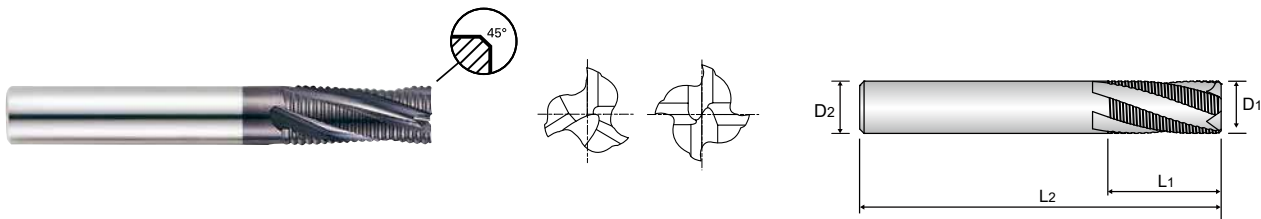

CARBIDE HR 3&4 20° PLAIN C x 45° P.394

Unit : mm

EDP No.	Mill Diameter	Shank Diameter	Length of Cut	Overall Length	No. of Flute	Chamfer
	D1	D2	L1	L2		
GM814060	6.0	6	16	57	3	0.38
GM814080	8.0	8	16	63	3	0.38
GM814100	10.0	10	22	72	4	0.60
GM814120	12.0	12	26	83	4	0.60
GM814160	16.0	16	32	92	4	0.60
GM814200	20.0	20	38	104	4	0.60

Tolerances according to DIN 7160 & 7161

	Tolerance range in µm				
	Nominal-Diameter in mm				
	from 1 to 3	over 3 to 6	over 6 to 10	over 10 to 18	over 18 to 30
h10	0 - 40	0 - 48	0 - 58	0 - 70	0 - 84
h5	0 - 4	0 - 5	0 - 6	0 - 8	0 - 9

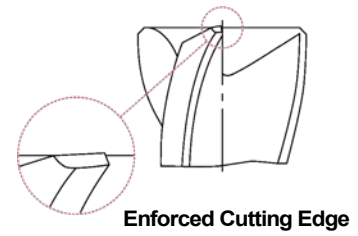

◎ : Excellent ○ : Good

ISO Material Description	P										M				K						
	Non-alloy steel					Low alloy steel					High alloyed steel, and tool steel				Stainless steel		Grey cast iron		Nodular cast iron		Malleable cast iron
VDI 3323	1	2	3	4	5	6	7	8	9	10	11	12	13	14	15	16	17	18	19	20	
HRc	13	25	28	32	30	29	32	38	35	35	35	15	23	10	10	26	3	25	42	55	
HB	125	190	250	270	300	180	275	300	350	200	325	200	240	180	180	260	160	250	130	230	
Recommend	○	○	○	◎	◎	○	◎	◎	◎	◎	◎	○	○	○	○	○	○	○	○	○	
ISO Material Description	N					S										H					
	Aluminum-wrought alloy		Aluminum-cast, alloyed			Copper and Copper Alloys (Bronze / Brass)			Non Metallic Materials		Heat Resistant Super Alloys					Titanium Alloys		Hardened steel	Chilled Cast Iron	Hardened Cast Iron	
VDI 3323	21	22	23	24	25	26	27	28	29	30	31	32	33	34	35	36	37	38	39	40	41
HRc	60	100	75	90	130	110	90	100			15	30	25	38	34	400 Rm	1050 Rm	55	60	42	55
HB	60	100	75	90	130	110	90	100			200	280	250	350	320	400 Rm	1050 Rm	550	630	400	550
Recommend																		○	◎	◎	○

GM876, GM813 SERIES 2 FLUTE BALL NOSE

Vc = m/min.
fz = mm/tooth
RPM = rev./min.
FEED = mm/min.
Ap = mm

NORMAL SPEED

ISO	VDI 3323	Material Description	Ae	Parameter	Diameter (Ø)															
					1.0	1.5	2.0	2.5	3.0	4.0	5.0	6.0	8.0	10.0	12.0	16.0	20.0			
P	1-4	Non-alloy steel	0.2D	Vc	55	85	100	125	140	150	160	180	200	225	245	270	290			
				fz	0.008	0.011	0.026	0.026	0.026	0.035	0.045	0.06	0.09	0.12	0.15	0.18	0.2			
				RPM	17507	18038	15915	15915	14854	11937	10186	9549	7958	7162	6499	5371	4615			
				FEED	280	397	828	828	772	836	917	1146	1432	1719	1950	1934	1846			
	5	Non-alloy steel	0.2D	Vc	45	65	75	95	105	120	130	145	160	180	195	215	230			
				fz	0.008	0.011	0.023	0.023	0.023	0.032	0.040	0.060	0.080	0.100	0.120	0.140	0.160			
				RPM	14324	13793	11937	12096	11141	9549	8276	7692	6366	5730	5173	4277	3661			
				FEED	229	303	549	556	512	611	662	923	1019	1146	1241	1198	1171			
	6-7	Low alloy steel	0.2D	Vc	55	85	100	125	140	150	160	180	200	225	245	270	290			
				fz	0.008	0.011	0.026	0.026	0.026	0.035	0.045	0.06	0.09	0.12	0.15	0.18	0.2			
				RPM	17507	18038	15915	15915	14854	11937	10186	9549	7958	7162	6499	5371	4615			
				FEED	280	397	828	828	772	836	917	1146	1432	1719	1950	1934	1846			
8-9	Low alloy steel	0.2D	Vc	45	65	75	95	105	120	130	145	160	180	195	215	230				
			fz	0.008	0.011	0.023	0.023	0.023	0.032	0.040	0.060	0.080	0.100	0.120	0.140	0.160				
			RPM	14324	13793	11937	12096	11141	9549	8276	7692	6366	5730	5173	4277	3661				
			FEED	229	303	549	556	512	611	662	923	1019	1146	1241	1198	1171				
10	High alloyed steel, and tool steel	0.2D	Vc	55	85	100	125	140	150	160	180	200	225	245	270	290				
			fz	0.008	0.011	0.026	0.026	0.026	0.035	0.045	0.06	0.09	0.12	0.15	0.18	0.2				
			RPM	17507	18038	15915	15915	14854	11937	10186	9549	7958	7162	6499	5371	4615				
			FEED	280	397	828	828	772	836	917	1146	1432	1719	1950	1934	1846				
11.1 - 11.2	High alloyed steel, and tool steel	0.2D	Vc	45	65	75	95	105	120	130	145	160	180	195	215	230				
			fz	0.008	0.011	0.023	0.023	0.023	0.032	0.040	0.060	0.080	0.100	0.120	0.140	0.160				
			RPM	14324	13793	11937	12096	11141	9549	8276	7692	6366	5730	5173	4277	3661				
			FEED	229	303	549	556	512	611	662	923	1019	1146	1241	1198	1171				
K	15-20	Grey cast iron Nodular cast iron Malleable cast iron	0.2D	Vc	55	80	100	125	135	145	160	180	200	220	245	265	290			
				fz	0.008	0.011	0.026	0.026	0.026	0.035	0.045	0.06	0.09	0.12	0.15	0.181	0.201			
				RPM	17507	16977	15915	15915	14324	11539	10186	9549	7958	7003	6499	5272	4615			
				FEED	280	373	828	828	745	808	917	1146	1432	1681	1950	1908	1855			
H	38.1 - 38.2	Hardened steel	0.1D	Vc	20	30	35	40	50	60	65	70	75	75	75	80				
				fz	0.008	0.011	0.016	0.016	0.017	0.021	0.024	0.030	0.044	0.055	0.070	0.091	0.113			
				RPM	6366	6366	5570	5093	5305	4775	4138	3448	2785	2228	1989	1492	1273			
				FEED	102	140	178	163	180	201	199	207	245	245	279	272	288			
	40	Chilled Cast Iron	0.2D	Vc	45	65	75	95	105	120	130	145	160	180	195	215	230			
				fz	0.008	0.011	0.023	0.023	0.023	0.032	0.040	0.060	0.080	0.100	0.120	0.140	0.160			
				RPM	14324	13793	11937	12096	11141	9549	8276	7692	6366	5730	5173	4277	3661			
				FEED	229	303	549	556	512	611	662	923	1019	1146	1241	1198	1171			
	41	Hardened Cast Iron	0.1D	Vc	20	30	35	40	50	60	65	70	75	75	75	80				
				fz	0.008	0.011	0.016	0.016	0.017	0.021	0.024	0.030	0.044	0.055	0.070	0.091	0.113			
				RPM	6366	6366	5570	5093	5305	4775	4138	3448	2785	2228	1989	1492	1273			
				FEED	102	140	178	163	180	201	199	207	245	245	279	272	288			

▶ NEXT PAGE

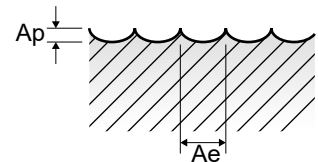

Vc = m/min.
fz = mm/tooth
RPM = rev./min.
FEED = mm/min.
Ap = mm

GM876, GM813 SERIES 2 FLUTE BALL NOSE

HIGH SPEED

ISO	VDI 3323	Material Description	Ae	Parameter	Diameter (Ø)															
					1.0	1.5	2.0	2.5	3.0	4.0	5.0	6.0	8.0	10.0	12.0	16.0	20.0			
P	1-5	Non-alloy steel	0.05D	Vc	90	120	150	185	220	295	370	445	470	495	515	540	560			
				fz	0.026	0.03	0.035	0.042	0.048	0.07	0.086	0.095	0.12	0.139	0.16	0.181	0.2			
				RPM	28648	25465	23873	23555	23343	23475	23555	23608	18701	15756	13661	10743	8913			
				FEED	1490	1528	1671	1979	2241	3287	4051	4486	4488	4380	4371	3889	3565			
	6-9	Low alloy steel	0.05D	Vc	90	120	150	185	220	295	370	445	470	495	515	540	560			
				fz	0.026	0.030	0.035	0.042	0.048	0.070	0.086	0.095	0.120	0.139	0.160	0.181	0.200			
				RPM	28648	25465	23873	23555	23343	23475	23555	23608	18701	15756	13661	10743	8913			
				FEED	1490	1528	1671	1979	2241	3287	4051	4486	4488	4380	4371	3889	3565			
	10 - 11.2	High alloyed steel, and tool steel	0.05D	Vc	90	120	150	185	220	295	370	445	470	495	515	540	560			
				fz	0.026	0.03	0.035	0.042	0.048	0.07	0.086	0.095	0.12	0.139	0.16	0.181	0.2			
				RPM	28648	25465	23873	23555	23343	23475	23555	23608	18701	15756	13661	10743	8913			
				FEED	1490	1528	1671	1979	2241	3287	4051	4486	4488	4380	4371	3889	3565			
K	15-20	Grey cast iron Nodular cast iron Malleable cast iron	0.05D	Vc	90	120	150	185	220	295	370	445	470	495	515	540	560			
				fz	0.026	0.03	0.035	0.042	0.048	0.07	0.086	0.095	0.12	0.139	0.16	0.181	0.2			
				RPM	28648	25465	23873	23555	23343	23475	23555	23608	18701	15756	13661	10743	8913			
				FEED	1490	1528	1671	1979	2241	3287	4051	4486	4488	4380	4371	3889	3565			
H	38.1 - 38.2	Hardened steel	0.05D	Vc	90	120	150	165	180	190	210	220	235	245	255	270	280			
				fz	0.016	0.019	0.022	0.026	0.031	0.042	0.050	0.060	0.075	0.086	0.095	0.105	0.115			
				RPM	28648	25465	23873	21008	19099	15120	13369	11671	9350	7799	6764	5371	4456			
				FEED	917	968	1050	1092	1184	1270	1337	1401	1403	1341	1285	1128	1025			
	40	Chilled Cast Iron	0.05D	Vc	90	120	150	185	220	295	370	445	470	495	515	540	560			
				fz	0.026	0.030	0.035	0.042	0.048	0.070	0.086	0.095	0.120	0.139	0.160	0.181	0.200			
				RPM	28648	25465	23873	23555	23343	23475	23555	23608	18701	15756	13661	10743	8913			
				FEED	1490	1528	1671	1979	2241	3287	4051	4486	4488	4380	4371	3889	3565			
	41	Hardened Cast Iron	0.05D	Vc	90	120	150	165	180	190	210	220	235	245	255	270	280			
				fz	0.016	0.019	0.022	0.026	0.031	0.042	0.050	0.060	0.075	0.086	0.095	0.105	0.115			
				RPM	28648	25465	23873	21008	19099	15120	13369	11671	9350	7799	6764	5371	4456			
				FEED	917	968	1050	1092	1184	1270	1337	1401	1403	1341	1285	1128	1025			
			0.05D	Ap	0.2	0.2	0.2	0.2	0.2	0.2	0.2	0.2	0.3	0.3	0.3	0.3				

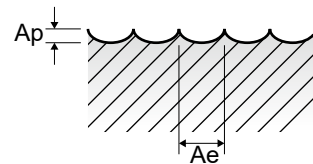

GM886 SERIES **2 FLUTE BALL NOSE RIB PROCESSING**

Vc = m/min.
fz = mm/tooth
RPM = rev./min.
FEED = mm/min.
Ap = mm

ISO	VDI 3323	Material Description	Parameter	Diameter (Ø)					
				0.5	0.6	0.8	1.0	1.2	1.4
P	1-4	Non-alloy steel	Vc	49~63	58~75	78~101	91~115	90~115	92~114
			fz	0.003~0.006	0.004~0.008	0.004~0.008	0.004~0.010	0.005~0.013	0.006~0.015
			RPM	32550~42000	32550~42000	32550~42000	30450~38330	25200~32030	22050~27300
			FEED	185~515	235~660	235~660	265~735	265~820	265~820
			Ap	0.023~0.045	0.027~0.054	0.036~0.072	0.045~0.090	0.055~0.100	0.062~0.125
			Vc	35~45	42~54	57~72	64~82	64~81	66~79
	5	Non-alloy steel	fz	0.002~0.005	0.002~0.006	0.002~0.006	0.003~0.008	0.004~0.009	0.004~0.011
			RPM	23630~29930	23630~29930	23630~29930	21530~27300	17850~22580	15750~18900
			FEED	90~285	115~370	115~370	130~410	130~410	130~410
			Ap	0.023~0.045	0.027~0.054	0.036~0.072	0.045~0.090	0.055~0.100	0.062~0.125
			Vc	49~63	58~75	78~101	91~115	90~115	92~114
			fz	0.003~0.006	0.004~0.008	0.004~0.008	0.004~0.010	0.005~0.013	0.006~0.015
	6-7	Low alloy steel	RPM	32550~42000	32550~42000	32550~42000	30450~38330	25200~32030	22050~27300
			FEED	185~515	235~660	235~660	265~735	265~820	265~820
			Ap	0.023~0.045	0.027~0.054	0.036~0.072	0.045~0.090	0.055~0.100	0.062~0.125
			Vc	35~45	42~54	57~72	64~82	64~81	66~79
			fz	0.002~0.005	0.002~0.006	0.002~0.006	0.003~0.008	0.004~0.009	0.004~0.011
			RPM	23630~29930	23630~29930	23630~29930	21530~27300	17850~22580	15750~18900
8-9	Low alloy steel	FEED	90~285	115~370	115~370	130~410	130~410	130~410	
		Ap	0.023~0.045	0.027~0.054	0.036~0.072	0.045~0.090	0.055~0.100	0.062~0.125	
		Vc	49~63	58~75	78~101	91~115	90~115	92~114	
		fz	0.003~0.006	0.004~0.008	0.004~0.008	0.004~0.010	0.005~0.013	0.006~0.015	
		RPM	32550~42000	32550~42000	32550~42000	30450~38330	25200~32030	22050~27300	
		FEED	185~515	235~660	235~660	265~735	265~820	265~820	
10	High alloyed steel, and tool steel	Ap	0.023~0.045	0.027~0.054	0.036~0.072	0.045~0.090	0.055~0.100	0.062~0.125	
		Vc	35~45	42~54	57~72	64~82	64~81	66~79	
		fz	0.002~0.005	0.002~0.006	0.002~0.006	0.003~0.008	0.004~0.009	0.004~0.011	
		RPM	23630~29930	23630~29930	23630~29930	21530~27300	17850~22580	15750~18900	
		FEED	90~285	115~370	115~370	130~410	130~410	130~410	
		Ap	0.023~0.045	0.027~0.054	0.036~0.072	0.045~0.090	0.055~0.100	0.062~0.125	
11.1 11.2	High alloyed steel, and tool steel	Vc	49~63	58~75	78~101	91~115	90~115	92~114	
		fz	0.003~0.006	0.004~0.008	0.004~0.008	0.004~0.010	0.005~0.013	0.006~0.015	
		RPM	32550~42000	32550~42000	32550~42000	30450~38330	25200~32030	22050~27300	
		FEED	185~515	235~660	235~660	265~735	265~820	265~820	
		Ap	0.023~0.045	0.027~0.054	0.036~0.072	0.045~0.090	0.055~0.100	0.062~0.125	
		Vc	35~45	42~54	57~72	64~82	64~81	66~79	
K	15-20	Grey cast iron Nodular cast iron Malleable cast iron	fz	0.002~0.005	0.002~0.006	0.002~0.006	0.003~0.008	0.004~0.009	0.004~0.011
			RPM	23630~29930	23630~29930	23630~29930	21530~27300	17850~22580	15750~18900
			FEED	90~285	115~370	115~370	130~410	130~410	130~410
			Ap	0.023~0.045	0.027~0.054	0.036~0.072	0.045~0.090	0.055~0.100	0.062~0.125
			Vc	49~63	58~75	78~101	91~115	90~115	92~114
			fz	0.003~0.006	0.004~0.008	0.004~0.008	0.004~0.010	0.005~0.013	0.006~0.015
H	38.1 38.2	Hardened steel	RPM	15020~18900	15020~18900	15020~18900	13650~17120	11340~14390	9870~12290
			FEED	90~185	115~235	115~235	130~265	130~265	130~265
			Ap	0.005~0.009	0.005~0.011	0.007~0.014	0.009~0.018	0.010~0.022	0.012~0.025
			Vc	22~28	27~34	36~45	41~51	41~52	41~51
			fz	0.003~0.005	0.004~0.006	0.004~0.006	0.005~0.008	0.006~0.009	0.007~0.011
			RPM	15020~18900	15020~18900	15020~18900	13650~17120	11340~14390	9870~12290
	40	Chilled Cast Iron	FEED	90~185	115~235	115~235	130~265	130~265	130~265
			Ap	0.005~0.009	0.005~0.011	0.007~0.014	0.009~0.018	0.010~0.022	0.012~0.025
			Vc	35~45	42~54	57~72	64~82	64~81	66~79
			fz	0.002~0.005	0.002~0.006	0.002~0.006	0.003~0.008	0.004~0.009	0.004~0.011
			RPM	23630~29930	23630~29930	23630~29930	21530~27300	17850~22580	15750~18900
			FEED	90~285	115~370	115~370	130~410	130~410	130~410
41	Hardened Cast Iron	Ap	0.023~0.045	0.027~0.054	0.036~0.072	0.045~0.090	0.055~0.100	0.062~0.125	
		Vc	22~28	27~34	36~45	41~51	41~52	41~51	
		fz	0.003~0.005	0.004~0.006	0.004~0.006	0.005~0.008	0.006~0.009	0.007~0.011	
		RPM	15020~18900	15020~18900	15020~18900	13650~17120	11340~14390	9870~12290	
		FEED	90~185	115~235	115~235	130~265	130~265	130~265	
		Ap	0.005~0.009	0.005~0.011	0.007~0.014	0.009~0.018	0.010~0.022	0.012~0.025	

▶ NEXT PAGE

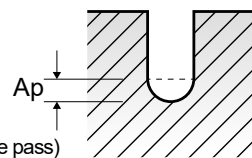

GM886 SERIES
2 FLUTE BALL NOSE RIB PROCESSING

Vc = m/min.
fz = mm/tooth
RPM = rev./min.
FEED = mm/min.
Ap = mm

VDI 3323		Diameter (Ø)							
		1.5	1.6	1.8	2.0	3.0	4.0	5.0	6.0
1-4	Vc	90~113	90~118	96~122	97~119	99~123	107~138	107~138	107~138
	fz	0.007~0.016	0.007~0.017	0.007~0.018	0.008~0.021	0.012~0.030	0.015~0.035	0.018~0.044	0.022~0.053
	RPM	19950~25200	18900~24680	17850~22580	16280~19950	11030~13650	8930~11550	7140~9240	5990~7670
	FEED	265~820	265~820	265~820	265~820	265~820	265~820	265~820	265~820
5	Ap	0.070~0.135	0.075~0.145	0.080~0.160	0.090~0.180	0.135~0.270	0.180~0.360	0.225~0.450	0.270~0.540
	Vc	64~82	66~83	68~85	69~85	66~85	73~98	72~97	74~98
	fz	0.005~0.011	0.005~0.012	0.005~0.013	0.006~0.014	0.009~0.022	0.011~0.025	0.014~0.031	0.016~0.038
	RPM	14180~18380	13860~17330	12600~15750	11550~14180	7350~9450	6090~8190	4830~6510	4100~5460
6-7	FEED	130~410	130~410	130~410	130~410	130~410	130~410	130~410	130~410
	Ap	0.070~0.135	0.075~0.145	0.080~0.160	0.090~0.180	0.135~0.270	0.180~0.360	0.225~0.450	0.270~0.540
	Vc	90~113	90~118	96~122	97~119	99~123	107~138	107~138	107~138
	fz	0.007~0.016	0.007~0.017	0.007~0.018	0.008~0.021	0.012~0.030	0.015~0.035	0.018~0.044	0.022~0.053
8-9	RPM	19950~25200	18900~24680	17850~22580	16280~19950	11030~13650	8930~11550	7140~9240	5990~7670
	FEED	265~820	265~820	265~820	265~820	265~820	265~820	265~820	265~820
	Ap	0.070~0.135	0.075~0.145	0.080~0.160	0.090~0.180	0.135~0.270	0.180~0.360	0.225~0.450	0.270~0.540
	Vc	64~82	66~83	68~85	69~85	66~85	73~98	72~97	74~98
10	fz	0.005~0.011	0.005~0.012	0.005~0.013	0.006~0.014	0.009~0.022	0.011~0.025	0.014~0.031	0.016~0.038
	RPM	14180~18380	13860~17330	12600~15750	11550~14180	7350~9450	6090~8190	4830~6510	4100~5460
	FEED	130~410	130~410	130~410	130~410	130~410	130~410	130~410	130~410
	Ap	0.070~0.135	0.075~0.145	0.080~0.160	0.090~0.180	0.135~0.270	0.180~0.360	0.225~0.450	0.270~0.540
11.1 - 11.2	Vc	90~113	90~118	96~122	97~119	99~123	107~138	107~138	107~138
	fz	0.007~0.016	0.007~0.017	0.007~0.018	0.008~0.021	0.012~0.030	0.015~0.035	0.018~0.044	0.022~0.053
	RPM	19950~25200	18900~24680	17850~22580	16280~19950	11030~13650	8930~11550	7140~9240	5990~7670
	FEED	265~820	265~820	265~820	265~820	265~820	265~820	265~820	265~820
15 - 20	Ap	0.070~0.135	0.075~0.145	0.080~0.160	0.090~0.180	0.135~0.270	0.180~0.360	0.225~0.450	0.270~0.540
	Vc	41~50	42~52	42~53	43~54	43~54	49~62	49~61	49~62
	fz	0.007~0.016	0.007~0.017	0.007~0.018	0.008~0.021	0.012~0.030	0.015~0.035	0.018~0.044	0.022~0.053
	RPM	19950~25200	18900~24680	17850~22580	16280~19950	11030~13650	8930~11550	7140~9240	5990~7670
38.1 - 38.2	FEED	265~820	265~820	265~820	265~820	265~820	265~820	265~820	265~820
	Ap	0.070~0.135	0.075~0.145	0.080~0.160	0.090~0.180	0.135~0.270	0.180~0.360	0.225~0.450	0.270~0.540
	Vc	41~50	42~52	42~53	43~54	43~54	49~62	49~61	49~62
	fz	0.007~0.012	0.008~0.012	0.008~0.013	0.009~0.015	0.014~0.022	0.016~0.026	0.020~0.032	0.024~0.038
40	RPM	9140~11240	8720~10920	7770~9870	7250~9030	4830~5990	4100~5150	3260~4100	2730~3470
	FEED	130~265	130~265	130~265	130~265	130~265	130~265	130~265	130~265
	Ap	0.014~0.028	0.015~0.030	0.016~0.032	0.018~0.035	0.028~0.055	0.035~0.070	0.044~0.088	0.053~0.105
	Vc	64~82	66~83	68~85	69~85	66~85	73~98	72~97	74~98
41	fz	0.005~0.011	0.005~0.012	0.005~0.013	0.006~0.014	0.009~0.022	0.011~0.025	0.014~0.031	0.016~0.038
	RPM	14180~18380	13860~17330	12600~15750	11550~14180	7350~9450	6090~8190	4830~6510	4100~5460
	FEED	130~410	130~410	130~410	130~410	130~410	130~410	130~410	130~410
	Ap	0.070~0.135	0.075~0.145	0.080~0.160	0.090~0.180	0.135~0.270	0.180~0.360	0.225~0.450	0.270~0.540
	Vc	41~50	42~52	42~53	43~54	43~54	49~62	49~61	49~62
	fz	0.007~0.012	0.008~0.012	0.008~0.013	0.009~0.015	0.014~0.022	0.016~0.026	0.020~0.032	0.024~0.038
	RPM	9140~11240	8720~10920	7770~9870	7250~9030	4830~5990	4100~5150	3260~4100	2730~3470
	FEED	130~265	130~265	130~265	130~265	130~265	130~265	130~265	130~265
	Ap	0.014~0.028	0.015~0.030	0.016~0.032	0.018~0.035	0.028~0.055	0.035~0.070	0.044~0.088	0.053~0.105

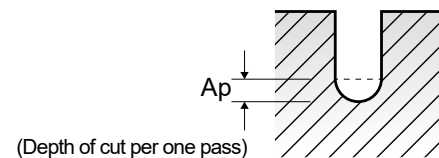

GM902 SERIES

2 FLUTE BALL NOSE with TAPER NECK

Vc = m/min.
fz = mm/tooth
RPM = rev./min.
FEED = mm/min.
Ap = mm

NORMAL SPEED

ISO	VDI 3323	Material Description	Ae	Parameter	Diameter (Ø)						
					1.0	2.0	3.0	4.0	5.0	6.0	8.0
H	5	Non-alloy steel	0.2D	Vc	35	60	80	90	95	110	120
				fz	0.008	0.014	0.023	0.031	0.040	0.060	0.080
				RPM	11141	9549	8488	7162	6048	5836	4775
				FEED	178	267	390	444	484	700	764
				Ap	0.2	0.2	0.2	0.2	0.2	0.2	0.3
	8-9	Low alloy steel	0.2D	Vc	35	60	80	90	95	110	120
				fz	0.008	0.014	0.023	0.031	0.040	0.060	0.080
				RPM	11141	9549	8488	7162	6048	5836	4775
				FEED	178	267	390	444	484	700	764
				Ap	0.2	0.2	0.2	0.2	0.2	0.2	0.3
11.1	High alloyed steel, and tool steel	0.2D	Vc	35	60	80	90	95	110	120	
			fz	0.008	0.014	0.023	0.031	0.040	0.060	0.080	
			RPM	11141	9549	8488	7162	6048	5836	4775	
			FEED	178	267	390	444	484	700	764	
			Ap	0.2	0.2	0.2	0.2	0.2	0.2	0.3	
11.2	High alloyed steel, and tool steel	0.1D	Vc	55	75	100	110	125	135	150	
			fz	0.012	0.028	0.043	0.052	0.059	0.067	0.075	
			RPM	17507	11937	10610	8754	7958	7162	5968	
			FEED	420	668	912	910	939	960	895	
			Ap	0.05	0.1	0.15	0.2	0.25	0.25	0.25	
H	38.1	Hardened steel	0.1D	Vc	55	75	100	110	125	135	150
				fz	0.012	0.028	0.043	0.052	0.059	0.067	0.075
				RPM	17507	11937	10610	8754	7958	7162	5968
				FEED	420	668	912	910	939	960	895
				Ap	0.05	0.1	0.15	0.2	0.25	0.25	0.25
	38.2	Hardened steel	0.1D	Vc	55	75	95	110	125	130	140
				fz	0.012	0.026	0.043	0.052	0.059	0.068	0.075
				RPM	17507	11937	10080	8754	7958	6897	5570
				FEED	420	621	867	910	939	938	836
				Ap	0.05	0.1	0.15	0.2	0.25	0.25	0.25
	40	Chilled Cast Iron	0.1D	Vc	55	75	100	110	125	135	150
				fz	0.012	0.028	0.043	0.052	0.059	0.067	0.075
				RPM	17507	11937	10610	8754	7958	7162	5968
				FEED	420	668	912	910	939	960	895
				Ap	0.05	0.1	0.15	0.2	0.25	0.25	0.25
	41	Hardened Cast Iron	0.1D	Vc	55	75	95	110	125	130	140
				fz	0.012	0.026	0.043	0.052	0.059	0.068	0.075
				RPM	17507	11937	10080	8754	7958	6897	5570
				FEED	420	621	867	910	939	938	836
				Ap	0.05	0.1	0.15	0.2	0.25	0.25	0.25

► NEXT PAGE

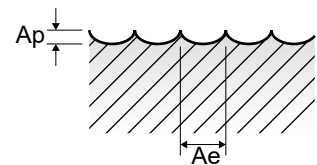

GM902 SERIES

2 FLUTE BALL NOSE with TAPER NECK

Vc = m/min.
fz = mm/tooth
RPM = rev./min.
FEED = mm/min.
Ap = mm

HIGH SPEED

ISO	VDI 3323	Material Description	Ae	Parameter	Diameter (Ø)						
					1.0	2.0	3.0	4.0	5.0	6.0	8.0
P	1-5	Non-alloy steel	0.05D	Vc	65	110	165	220	275	335	355
				fz	0.026	0.036	0.048	0.07	0.086	0.095	0.119
				RPM	20690	17507	17507	17507	17507	17772	14125
				FEED	1076	1261	1681	2451	3011	3377	3362
	6-9	Low alloy steel	0.05D	Vc	65	110	165	220	275	335	355
				fz	0.026	0.036	0.048	0.070	0.086	0.095	0.119
				RPM	20690	17507	17507	17507	17507	17772	14125
				FEED	1076	1261	1681	2451	3011	3377	3362
	10-11.2	High alloyed steel, and tool steel	0.05D	Vc	65	110	165	220	275	335	355
fz	0.026	0.036	0.048	0.07	0.086	0.095	0.119				
RPM	20690	17507	17507	17507	17507	17772	14125				
FEED	1076	1261	1681	2451	3011	3377	3362				
K	15-20	Grey cast iron Nodular cast iron Malleable cast iron	0.05D	Vc	65	110	165	220	275	335	355
				fz	0.026	0.036	0.048	0.07	0.086	0.095	0.119
				RPM	20690	17507	17507	17507	17507	17772	14125
				FEED	1076	1261	1681	2451	3011	3377	3362
H	38	Hardened steel	0.05D	Vc	55	75	100	110	125	135	150
				fz	0.019	0.037	0.069	0.080	0.088	0.101	0.112
				RPM	17507	11937	10610	8754	7958	7162	5968
				FEED	665	883	1464	1401	1401	1447	1337
	38.2	Hardened steel	0.05D	Vc	55	75	95	110	120	130	140
				fz	0.017	0.043	0.066	0.079	0.087	0.102	0.109
				RPM	17507	11937	10080	8754	7639	6897	5570
				FEED	595	1027	1331	1383	1329	1407	1214
	40	Chilled Cast Iron	0.05D	Vc	65	110	165	220	275	335	355
				fz	0.026	0.036	0.048	0.07	0.086	0.095	0.119
				RPM	20690	17507	17507	17507	17507	17772	14125
				FEED	1076	1261	1681	2451	3011	3377	3362
	41	Hardened Cast Iron	0.05D	Vc	55	75	95	110	120	130	140
				fz	0.017	0.043	0.066	0.079	0.087	0.102	0.109
				RPM	17507	11937	10080	8754	7639	6897	5570
				FEED	595	1027	1331	1383	1329	1407	1214
			0.05D	Vc	55	75	95	110	120	130	140
				fz	0.017	0.043	0.066	0.079	0.087	0.102	0.109
				RPM	17507	11937	10080	8754	7639	6897	5570
				FEED	595	1027	1331	1383	1329	1407	1214
			0.05D	Vc	55	75	95	110	120	130	140
				fz	0.017	0.043	0.066	0.079	0.087	0.102	0.109
				RPM	17507	11937	10080	8754	7639	6897	5570
				FEED	595	1027	1331	1383	1329	1407	1214
			0.05D	Vc	55	75	95	110	120	130	140
				fz	0.017	0.043	0.066	0.079	0.087	0.102	0.109
				RPM	17507	11937	10080	8754	7639	6897	5570
				FEED	595	1027	1331	1383	1329	1407	1214
			0.05D	Vc	55	75	95	110	120	130	140
				fz	0.017	0.043	0.066	0.079	0.087	0.102	0.109
				RPM	17507	11937	10080	8754	7639	6897	5570
				FEED	595	1027	1331	1383	1329	1407	1214

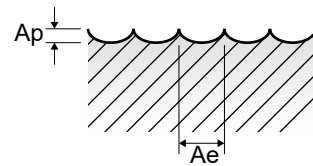

GM815 SERIES 4 FLUTE BALL NOSE

Vc = m/min.
fz = mm/tooth
RPM = rev./min.
FEED = mm/min.
Ap = mm

NORMAL SPEED

ISO	VDI 3323	Material Description	Ae	Parameter	Diameter (Ø)									
					2.0	3.0	4.0	5.0	6.0	8.0	10.0	12.0	16.0	
P	1-4	Non-alloy steel	0.2D	Vc	105	130	140	150	170	190	210	230	250	
				fz	0.013	0.019	0.026	0.034	0.045	0.068	0.09	0.111	0.136	
				RPM	16711	13793	11141	9549	9019	7560	6685	6101	4974	
				FEED	869	1048	1159	1299	1623	2056	2406	2709	2706	
				Ap	0.2	0.2	0.2	0.2	0.2	0.3	0.3	0.3	0.3	
	5	Non-alloy steel	0.2D	Vc	75	100	110	120	135	150	170	185	200	
				fz	0.010	0.017	0.024	0.030	0.045	0.060	0.075	0.089	0.106	
				RPM	11937	10610	8754	7639	7162	5968	5411	4907	3979	
				FEED	477	722	840	917	1289	1432	1623	1747	1687	
				Ap	0.2	0.2	0.2	0.2	0.2	0.3	0.3	0.3	0.3	
P	6-7	Low alloy steel	0.2D	Vc	105	130	140	150	170	190	210	230	250	
				fz	0.013	0.019	0.026	0.034	0.045	0.068	0.09	0.111	0.136	
				RPM	16711	13793	11141	9549	9019	7560	6685	6101	4974	
				FEED	869	1048	1159	1299	1623	2056	2406	2709	2706	
				Ap	0.2	0.2	0.2	0.2	0.2	0.3	0.3	0.3	0.3	
	8-9	Low alloy steel	0.2D	Vc	75	100	110	120	135	150	170	185	200	
				fz	0.010	0.017	0.024	0.030	0.045	0.060	0.075	0.089	0.106	
				RPM	11937	10610	8754	7639	7162	5968	5411	4907	3979	
				FEED	477	722	840	917	1289	1432	1623	1747	1687	
				Ap	0.2	0.2	0.2	0.2	0.2	0.3	0.3	0.3	0.3	
P	10	High alloyed steel, and tool steel	0.2D	Vc	105	130	140	150	170	190	210	230	250	
				fz	0.013	0.019	0.026	0.034	0.045	0.068	0.09	0.111	0.136	
				RPM	16711	13793	11141	9549	9019	7560	6685	6101	4974	
				FEED	869	1048	1159	1299	1623	2056	2406	2709	2706	
				Ap	0.2	0.2	0.2	0.2	0.2	0.3	0.3	0.3	0.3	
	11.1 - 11.2	High alloyed steel, and tool steel	0.2D	Vc	75	100	110	120	135	150	170	185	200	
				fz	0.010	0.017	0.024	0.030	0.045	0.060	0.075	0.089	0.106	
				RPM	11937	10610	8754	7639	7162	5968	5411	4907	3979	
				FEED	477	722	840	917	1289	1432	1623	1747	1687	
				Ap	0.2	0.2	0.2	0.2	0.2	0.3	0.3	0.3	0.3	
K	15-20	Grey cast iron Nodular cast iron Malleable cast iron	0.2D	Vc	105	130	140	150	170	190	210	230	250	
				fz	0.013	0.019	0.026	0.034	0.045	0.068	0.09	0.111	0.136	
				RPM	16711	13793	11141	9549	9019	7560	6685	6101	4974	
				FEED	869	1048	1159	1299	1623	2056	2406	2709	2706	
				Ap	0.2	0.2	0.2	0.2	0.2	0.3	0.3	0.3	0.3	
	H	38.1 - 39.2	Hardened steel	0.1D	Vc	30	45	55	60	65	65	65	70	70
					fz	0.008	0.012	0.016	0.018	0.022	0.033	0.041	0.053	0.069
					RPM	4775	4775	4377	3820	3448	2586	2069	1857	1393
					FEED	153	229	280	275	303	341	339	394	384
					Ap	0.2	0.2	0.2	0.2	0.2	0.3	0.3	0.3	0.3
40		Chilled Cast Iron	0.2D	Vc	75	100	110	120	135	150	170	185	200	
				fz	0.01	0.017	0.024	0.03	0.045	0.06	0.075	0.089	0.106	
				RPM	11937	10610	8754	7639	7162	5968	5411	4907	3979	
				FEED	477	722	840	917	1289	1432	1623	1747	1687	
				Ap	0.2	0.2	0.2	0.2	0.2	0.3	0.3	0.3	0.3	
41	Hardened Cast Iron	0.1D	Vc	30	45	55	60	65	65	65	70	70		
			fz	0.008	0.012	0.016	0.018	0.022	0.033	0.041	0.053	0.069		
			RPM	4775	4775	4377	3820	3448	2586	2069	1857	1393		
			FEED	153	229	280	275	303	341	339	394	384		
			Ap	0.2	0.2	0.2	0.2	0.2	0.3	0.3	0.3	0.3		

▶ NEXT PAGE

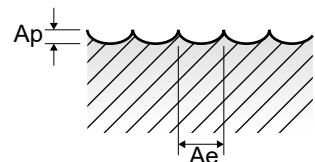

GM815 SERIES 4 FLUTE BALL NOSE

Vc = m/min.
fz = mm/tooth
RPM = rev./min.
FEED = mm/min.
Ap = mm

HIGH SPEED

ISO	VDI 3323	Material Description	Ae	Parameter	Diameter (Ø)								
					2.0	3.0	4.0	5.0	6.0	8.0	10.0	12.0	16.0
P	1-5	Non-alloy steel	0.05D	Vc	140	210	275	345	415	440	460	485	505
				fz	0.026	0.036	0.052	0.064	0.071	0.09	0.105	0.12	0.136
				RPM	22282	22282	21884	21963	22016	17507	14642	12865	10047
				FEED	2317	3209	4552	5623	6253	6303	6150	6175	5465
				Ap	0.2	0.2	0.2	0.2	0.2	0.3	0.3	0.3	0.3
	6-9	Low alloy steel	0.05D	Vc	140	210	275	345	415	440	460	485	505
				fz	0.026	0.036	0.052	0.064	0.071	0.090	0.105	0.120	0.136
				RPM	22282	22282	21884	21963	22016	17507	14642	12865	10047
				FEED	2317	3209	4552	5623	6253	6303	6150	6175	5465
				Ap	0.2	0.2	0.2	0.2	0.2	0.3	0.3	0.3	0.3
	10-11.2	High alloyed steel, and tool steel	0.05D	Vc	140	210	275	345	415	440	460	485	505
				fz	0.026	0.036	0.052	0.064	0.071	0.09	0.105	0.12	0.136
RPM				22282	22282	21884	21963	22016	17507	14642	12865	10047	
FEED				2317	3209	4552	5623	6253	6303	6150	6175	5465	
Ap				0.2	0.2	0.2	0.2	0.2	0.3	0.3	0.3	0.3	
K	15-20	Grey cast iron Nodular cast iron Malleable cast iron	0.05D	Vc	140	210	275	345	415	440	460	485	505
				fz	0.026	0.036	0.052	0.064	0.071	0.09	0.105	0.12	0.136
				RPM	22282	22282	21884	21963	22016	17507	14642	12865	10047
				FEED	2317	3209	4552	5623	6253	6303	6150	6175	5465
				Ap	0.2	0.2	0.2	0.2	0.2	0.3	0.3	0.3	0.3
H	38.1-39.2	Hardened steel	0.05D	Vc	140	170	180	200	210	220	230	240	250
				fz	0.017	0.023	0.032	0.038	0.045	0.056	0.064	0.071	0.079
				RPM	22282	18038	14324	12732	11141	8754	7321	6366	4974
				FEED	1515	1659	1833	1935	2005	1961	1874	1808	1572
				Ap	0.2	0.2	0.2	0.2	0.2	0.3	0.3	0.3	0.3
	40	Chilled Cast Iron	0.05D	Vc	140	210	275	345	415	440	460	485	505
				fz	0.026	0.036	0.052	0.064	0.071	0.09	0.105	0.12	0.136
				RPM	22282	22282	21884	21963	22016	17507	14642	12865	10047
				FEED	2317	3209	4552	5623	6253	6303	6150	6175	5465
				Ap	0.2	0.2	0.2	0.2	0.2	0.3	0.3	0.3	0.3
	41	Hardened Cast Iron	0.05D	Vc	140	170	180	200	210	220	230	240	250
				fz	0.017	0.023	0.032	0.038	0.045	0.056	0.064	0.071	0.079
				RPM	22282	18038	14324	12732	11141	8754	7321	6366	4974
				FEED	1515	1659	1833	1935	2005	1961	1874	1808	1572
				Ap	0.2	0.2	0.2	0.2	0.2	0.3	0.3	0.3	0.3

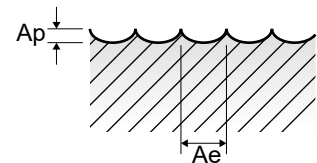

GM818 SERIES 2 FLUTE CORNER RADIUS - SLOTTING

Vc = m/min.
fz = mm/tooth
RPM = rev./min.
FEED = mm/min.

ISO	VDI 3323	Material Description	Ae	Ap	Parameter	Diameter (Ø)					
						4.0	5.0	6.0	8.0	10.0	12.0
P	1-4	Non-alloy steel	1.0D	0.3D	Vc	75	80	80	85	85	85
					fz	0.016	0.023	0.032	0.045	0.053	0.051
	5	Non-alloy steel	1.0D	0.3D	RPM	5968	5093	4244	3382	2706	2255
					FEED	191	234	272	304	287	230
	6-7	Low alloy steel	1.0D	0.3D	Vc	45	50	50	55	55	60
					fz	0.013	0.017	0.025	0.033	0.039	0.041
	8-9	Low alloy steel	1.0D	0.3D	RPM	3581	3183	2653	2188	1751	1592
					FEED	93	108	133	144	137	131
	10	High alloyed steel, and tool steel	1.0D	0.3D	Vc	75	80	80	85	85	85
					fz	0.016	0.023	0.032	0.045	0.053	0.051
11.1 - 11.2	High alloyed steel, and tool steel	1.0D	0.3D	RPM	5968	5093	4244	3382	2706	2255	
				FEED	191	234	272	304	287	230	
K	15-20	Grey cast iron Nodular cast iron Malleable cast iron	1.0D	0.3D	Vc	45	50	50	55	55	60
					fz	0.013	0.017	0.025	0.033	0.039	0.041
	38.1 - 38.2	Hardened steel	1.0D	0.3D	RPM	3581	3183	2653	2188	1751	1592
					FEED	93	108	133	144	137	131
	40	Chilled Cast Iron	1.0D	0.3D	Vc	75	80	80	85	85	85
					fz	0.016	0.023	0.032	0.045	0.053	0.051
	41	Hardened Cast Iron	1.0D	0.3D	RPM	5968	5093	4244	3382	2706	2255
					FEED	191	234	272	304	287	230
	38.1 - 38.2	Hardened steel	1.0D	0.3D	Vc	30	35	35	35	35	35
					fz	0.006	0.008	0.010	0.013	0.016	0.019
40	Chilled Cast Iron	1.0D	0.3D	RPM	2387	2228	1857	1393	1114	928	
				FEED	29	36	37	36	36	35	
41	Hardened Cast Iron	1.0D	0.3D	Vc	45	50	50	55	55	60	
				fz	0.013	0.017	0.025	0.033	0.039	0.041	
41	Hardened Cast Iron	1.0D	0.3D	RPM	3581	3183	2653	2188	1751	1592	
				FEED	93	108	133	144	137	131	
41	Hardened Cast Iron	1.0D	0.3D	Vc	30	35	35	35	35	35	
				fz	0.006	0.008	0.01	0.013	0.016	0.019	
41	Hardened Cast Iron	1.0D	0.3D	RPM	2387	2228	1857	1393	1114	928	
				FEED	29	36	37	36	36	35	

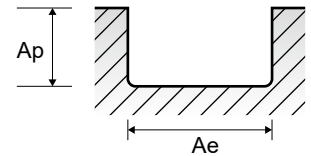

**GM8A1** SERIES**2 FLUTE CORNER RADIUS RIB PROCESSING**

Vc = m/min.
fz = mm/tooth
RPM = rev./min.
FEED = mm/min.
Ap = mm

ISO	VDI 3323	Material Description	Parameter	Diameter (Ø)					
				1.0	1.2	1.4	1.5	1.6	1.8
P	1-4	Non-alloy steel	Vc	71~88	70~85	70~88	68~87	70~90	74~93
			fz	0.006~0.014	0.008~0.020	0.009~0.023	0.010~0.024	0.010~0.025	0.011~0.027
			RPM	23630~29400	19430~23630	16800~21000	15230~19430	14700~18900	13650~17330
			FEED	295~850	295~945	295~945	295~945	295~945	295~945
	Ap		0.045~0.090	0.055~0.100	0.062~0.125	0.070~0.135	0.075~0.145	0.080~0.160	
	5		Vc	49~63	49~62	51~62	49~64	51~64	52~65
			fz	0.006~0.015	0.007~0.018	0.008~0.021	0.009~0.022	0.009~0.023	0.010~0.026
			RPM	16490~21000	13650~17330	12080~14700	11030~14180	10710~13440	9660~12080
		FEED	200~630	200~630	200~630	200~630	200~630	200~630	
	6-7	Vc	71~88	70~85	70~88	68~87	70~90	74~93	
		fz	0.006~0.014	0.008~0.020	0.009~0.023	0.010~0.024	0.010~0.025	0.011~0.027	
		RPM	23630~29400	19430~23630	16800~21000	15230~19430	14700~18900	13650~17330	
		FEED	295~850	295~945	295~945	295~945	295~945	295~945	
	8-9	Vc	49~63	49~62	51~62	49~64	51~64	52~65	
		fz	0.006~0.015	0.007~0.018	0.008~0.021	0.009~0.022	0.009~0.023	0.010~0.026	
		RPM	16490~21000	13650~17330	12080~14700	11030~14180	10710~13440	9660~12080	
		FEED	200~630	200~630	200~630	200~630	200~630	200~630	
	10	Vc	71~88	70~85	70~88	68~87	70~90	74~93	
		fz	0.006~0.014	0.008~0.020	0.009~0.023	0.010~0.024	0.010~0.025	0.011~0.027	
		RPM	23630~29400	19430~23630	16800~21000	15230~19430	14700~18900	13650~17330	
FEED		295~850	295~945	295~945	295~945	295~945	295~945		
11.1 11.2	Vc	49~63	49~62	51~62	49~64	51~64	52~65		
	fz	0.006~0.015	0.007~0.018	0.008~0.021	0.009~0.022	0.009~0.023	0.010~0.026		
	RPM	16490~21000	13650~17330	12080~14700	11030~14180	10710~13440	9660~12080		
	FEED	200~630	200~630	200~630	200~630	200~630	200~630		
K	15-20	Grey cast iron Nodular cast iron Malleable cast iron	Vc	71~88	70~85	70~88	68~87	70~90	74~93
			fz	0.006~0.014	0.008~0.020	0.009~0.023	0.010~0.024	0.010~0.025	0.011~0.027
			RPM	23630~29400	19430~23630	16800~21000	15230~19430	14700~18900	13650~17330
			FEED	295~850	295~945	295~945	295~945	295~945	295~945
H	38.1 - 38.2	Hardened steel	Vc	31~39	31~40	32~40	32~39	32~40	32~41
			fz	0.003~0.005	0.004~0.006	0.005~0.007	0.005~0.008	0.005~0.008	0.006~0.009
			RPM	10500~13130	8720~11030	7560~9450	7040~8610	6720~8400	5990~7560
			FEED	70~135	70~135	70~135	70~135	70~135	70~135
	40	Chilled Cast Iron	Vc	49~63	49~62	51~62	49~64	51~64	52~65
			fz	0.006~0.015	0.007~0.018	0.008~0.021	0.009~0.022	0.009~0.023	0.010~0.026
			RPM	16490~21000	13650~17330	12080~14700	11030~14180	10710~13440	9660~12080
			FEED	200~630	200~630	200~630	200~630	200~630	200~630
	41	Hardened Cast Iron	Vc	31~39	31~40	32~40	32~39	32~40	32~41
			fz	0.003~0.005	0.004~0.006	0.005~0.007	0.005~0.008	0.005~0.008	0.006~0.009
			RPM	10500~13130	8720~11030	7560~9450	7040~8610	6720~8400	5990~7560
			FEED	70~135	70~135	70~135	70~135	70~135	70~135
			Ap	0.009~0.018	0.010~0.022	0.012~0.025	0.014~0.028	0.015~0.030	0.016~0.032

▶ NEXT PAGE

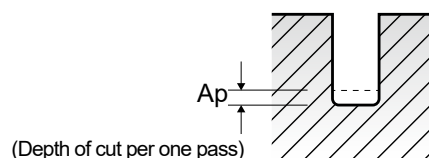

GM8A1 SERIES

2 FLUTE CORNER RADIUS RIB PROCESSING

Vc = m/min.
fz = mm/tooth
RPM = rev./min.
FEED = mm/min.
Ap = mm

ISO	VDI 3323	Material Description	Parameter	Diameter (Ø)					
				2.0	2.5	3.0	4.0	5.0	6.0
P	1-4	Non-alloy steel	Vc	75~91	75~94	75~94	75~94	75~94	75~94
			fz	0.012~0.031	0.015~0.038	0.018~0.045	0.023~0.060	0.029~0.075	0.035~0.090
			RPM	12600~15230	9980~12600	8400~10500	6300~7880	5040~6300	4200~5250
			FEED	295~945	295~945	295~945	295~945	295~945	295~945
	5	Non-alloy steel	Vc	52~66	53~67	52~66	52~67	52~66	53~66
			fz	0.011~0.029	0.014~0.035	0.017~0.043	0.023~0.057	0.029~0.071	0.034~0.086
			RPM	8720~11030	7040~8930	5780~7350	4310~5570	3470~4410	2940~3680
			FEED	200~630	200~630	200~630	200~630	200~630	200~630
	6-7	Low alloy steel	Vc	0.090~0.180	0.112~0.235	0.135~0.270	0.180~0.360	0.225~0.450	0.270~0.540
			fz	75~91	75~94	75~94	75~94	75~94	75~94
			RPM	12600~15230	9980~12600	8400~10500	6300~7880	5040~6300	4200~5250
			FEED	295~945	295~945	295~945	295~945	295~945	295~945
8-9	Low alloy steel	Vc	0.090~0.180	0.112~0.235	0.135~0.270	0.180~0.360	0.225~0.450	0.270~0.540	
		fz	52~66	53~67	52~66	52~67	52~66	53~66	
		RPM	8720~11030	7040~8930	5780~7350	4310~5570	3470~4410	2940~3680	
		FEED	200~630	200~630	200~630	200~630	200~630	200~630	
10	High alloyed steel, and tool steel	Vc	0.090~0.180	0.112~0.235	0.135~0.270	0.180~0.360	0.225~0.450	0.270~0.540	
		fz	75~91	75~94	75~94	75~94	75~94	75~94	
		RPM	12600~15230	9980~12600	8400~10500	6300~7880	5040~6300	4200~5250	
		FEED	295~945	295~945	295~945	295~945	295~945	295~945	
11.1 11.2	High alloyed steel, and tool steel	Vc	0.090~0.180	0.112~0.235	0.135~0.270	0.180~0.360	0.225~0.450	0.270~0.540	
		fz	52~66	53~67	52~66	52~67	52~66	53~66	
		RPM	8720~11030	7040~8930	5780~7350	4310~5570	3470~4410	2940~3680	
		FEED	200~630	200~630	200~630	200~630	200~630	200~630	
K	15-20	Grey cast iron Nodular cast iron Malleable cast iron	Vc	0.090~0.180	0.112~0.235	0.135~0.270	0.180~0.360	0.225~0.450	0.270~0.540
			fz	75~91	75~94	75~94	75~94	75~94	75~94
			RPM	12600~15230	9980~12600	8400~10500	6300~7880	5040~6300	4200~5250
			FEED	295~945	295~945	295~945	295~945	295~945	295~945
H	38.1 38.2	Hardened steel	Vc	0.090~0.180	0.112~0.235	0.135~0.270	0.180~0.360	0.225~0.450	0.270~0.540
			fz	33~41	34~42	33~41	33~41	33~41	33~49
			RPM	5570~6930	4520~5570	3680~4620	2730~3470	2210~2730	1840~2730
			FEED	70~135	70~135	70~135	70~135	70~135	70~135
H	40	Chilled Cast Iron	Vc	0.018~0.035	0.022~0.045	0.028~0.055	0.036~0.072	0.045~0.090	0.054~0.108
			fz	52~66	53~67	52~66	52~67	52~66	53~66
			RPM	8720~11030	7040~8930	5780~7350	4310~5570	3470~4410	2940~3680
			FEED	200~630	200~630	200~630	200~630	200~630	200~630
H	41	Hardened Cast Iron	Vc	0.090~0.180	0.112~0.235	0.135~0.270	0.180~0.360	0.225~0.450	0.270~0.540
			fz	33~41	34~42	33~41	33~41	33~41	33~49
			RPM	5570~6930	4520~5570	3680~4620	2730~3470	2210~2730	1840~2730
			FEED	70~135	70~135	70~135	70~135	70~135	70~135

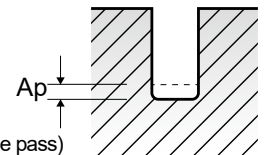

GM839 SERIES

4 FLUTE CORNER RADIUS - SIDE CUTTING

Vc = m/min.
 fz = mm/tooth
 RPM = rev./min.
 FEED = mm/min.

ISO	VDI 3323	Material Description	Ae	Ap	Parameter	Diameter (Ø)						
						2.0	3.0	4.0	6.0	8.0	10.0	12.0
P	1-4	Non-alloy steel	0.05D	1.0D	Vc	95	110	125	140	140	135	135
					fz	0.006	0.009	0.019	0.03	0.042	0.047	0.048
	RPM		15120	11671	9947	7427	5570	4297	3581			
	FEED		363	420	756	891	936	808	688			
	5	Low alloy steel	0.05D	1.0D	Vc	65	70	75	85	85	85	85
					fz	0.006	0.009	0.019	0.030	0.038	0.037	0.037
	RPM		10345	7427	5968	4509	3382	2706	2255			
	FEED		248	267	454	541	514	400	334			
	6-7	Low alloy steel	0.05D	1.0D	Vc	95	110	125	140	140	135	135
					fz	0.006	0.009	0.019	0.03	0.042	0.047	0.048
	RPM		15120	11671	9947	7427	5570	4297	3581			
	FEED		363	420	756	891	936	808	688			
8-9	Low alloy steel	0.05D	1.0D	Vc	65	70	75	85	85	85	85	
				fz	0.006	0.009	0.019	0.030	0.038	0.037	0.037	
RPM		10345	7427	5968	4509	3382	2706	2255				
FEED		248	267	454	541	514	400	334				
10	High alloyed steel, and tool steel	0.05D	1.0D	Vc	95	110	125	140	140	135	135	
				fz	0.006	0.009	0.019	0.03	0.042	0.047	0.048	
RPM		15120	11671	9947	7427	5570	4297	3581				
FEED		363	420	756	891	936	808	688				
11.1 - 11.2	High alloyed steel, and tool steel	0.05D	1.0D	Vc	65	70	75	85	85	85	85	
				fz	0.006	0.009	0.019	0.030	0.038	0.037	0.037	
RPM		10345	7427	5968	4509	3382	2706	2255				
FEED		248	267	454	541	514	400	334				
K	15-20	Grey cast iron Nodular cast iron Malleable cast iron	0.05D	1.0D	Vc	95	110	125	140	140	135	135
					fz	0.006	0.009	0.019	0.03	0.042	0.047	0.048
					RPM	15120	11671	9947	7427	5570	4297	3581
					FEED	363	420	756	891	936	808	688
H	38.1 - 38.2	Hardened steel	0.05D	1.0D	Vc	40	40	50	50	55	55	60
					fz	0.002	0.004	0.005	0.010	0.016	0.017	0.017
	RPM		6366	4244	3979	2653	2188	1751	1592			
	FEED		51	68	80	106	140	119	108			
	40	Chilled Cast Iron	0.05D	1.0D	Vc	65	70	75	85	85	85	85
					fz	0.006	0.009	0.019	0.030	0.038	0.037	0.037
	RPM		10345	7427	5968	4509	3382	2706	2255			
	FEED		248	267	454	541	514	400	334			
	41	Hardened Cast Iron	0.05D	1.0D	Vc	40	40	50	50	55	55	60
					fz	0.002	0.004	0.005	0.010	0.016	0.017	0.017
	RPM		6366	4244	3979	2653	2188	1751	1592			
	FEED		51	68	80	106	140	119	108			

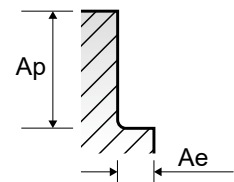

GM819 SERIES 4 FLUTE CORNER RADIUS - **SIDE CUTTING**

Vc = m/min.
fz = mm/tooth
RPM = rev./min.
FEED = mm/min.

ISO	VDI 3323	Material Description	Ae	Ap	Parameter	Diameter (Ø)									
						3.0	4.0	5.0	6.0	8.0	10.0	12.0	16.0	20.0	
P	1-4	Non-alloy steel	0.05D	2.5D	Vc	70	75	80	80	85	85	85	95	85	
					fz	0.006	0.01	0.012	0.014	0.019	0.023	0.022	0.023	0.022	
	RPM	7427	5968	5093	4244	3382	2706	2255	1890	1353					
	FEED	178	239	244	238	257	249	198	174	119					
	5	Non-alloy steel	0.05D	2.5D	Vc	45	45	50	50	55	55	60	60	55	
					fz	0.008	0.011	0.016	0.018	0.024	0.028	0.029	0.030	0.028	
	RPM	4775	3581	3183	2653	2188	1751	1592	1194	875					
	FEED	153	158	204	191	210	196	185	143	98					
	6-7	Low alloy steel	0.05D	2.5D	Vc	70	75	80	80	85	85	85	95	85	
					fz	0.006	0.01	0.012	0.014	0.019	0.023	0.022	0.023	0.022	
RPM	7427	5968	5093	4244	3382	2706	2255	1890	1353						
FEED	178	239	244	238	257	249	198	174	119						
8-9	Low alloy steel	0.05D	2.5D	Vc	45	45	50	50	55	55	60	60	55		
				fz	0.008	0.011	0.016	0.018	0.024	0.028	0.029	0.030	0.028		
RPM	4775	3581	3183	2653	2188	1751	1592	1194	875						
FEED	153	158	204	191	210	196	185	143	98						
10	High alloyed steel, and tool steel	0.05D	2.5D	Vc	70	75	80	80	85	85	85	95	85		
				fz	0.006	0.01	0.012	0.014	0.019	0.023	0.022	0.023	0.022		
RPM	7427	5968	5093	4244	3382	2706	2255	1890	1353						
FEED	178	239	244	238	257	249	198	174	119						
11.1 - 11.2	High alloyed steel, and tool steel	0.05D	2.5D	Vc	45	45	50	50	55	55	60	60	55		
				fz	0.008	0.011	0.016	0.018	0.024	0.028	0.029	0.030	0.028		
RPM	4775	3581	3183	2653	2188	1751	1592	1194	875						
FEED	153	158	204	191	210	196	185	143	98						
K	15-20	Grey cast iron Nodular cast iron Malleable cast iron	0.05D	2.5D	Vc	70	75	80	80	85	85	85	95	85	
fz	0.006	0.01	0.012	0.014	0.019	0.023	0.022	0.023	0.022						
RPM	7427	5968	5093	4244	3382	2706	2255	1890	1353						
FEED	178	239	244	238	257	249	198	174	119						
H	38.1 - 38.2	Hardened steel	0.02D	2.0D	Vc	25	30	35	35	35	35	35	35	35	
					fz	0.006	0.008	0.011	0.013	0.017	0.021	0.020	0.022	0.023	
	RPM	2653	2387	2228	1857	1393	1114	928	696	557					
	FEED	64	76	98	97	95	94	74	61	51					
	40	Chilled Cast Iron	0.05D	2.5D	Vc	45	45	50	50	55	55	60	60	55	
					fz	0.008	0.011	0.016	0.018	0.024	0.028	0.029	0.030	0.028	
RPM	4775	3581	3183	2653	2188	1751	1592	1194	875						
FEED	153	158	204	191	210	196	185	143	98						
41	Hardened Cast Iron	0.02D	2.0D	Vc	25	30	35	35	35	35	35	35	35		
				fz	0.006	0.008	0.011	0.013	0.017	0.021	0.020	0.022	0.023		
RPM	2653	2387	2228	1857	1393	1114	928	696	557						
FEED	64	76	98	97	95	94	74	61	51						

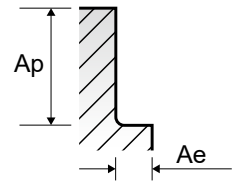

GM810 SERIES 2 FLUTE - SLOTTING

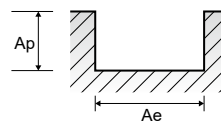

Vc = m/min.
fz = mm/tooth
RPM = rev./min.
FEED = mm/min.

ISO	VDI 3323	Material Description	Ae	Ap	Parameter	Diameter (∅)				
						0.4	0.8	1.0	1.2	1.5
P	5	Non-alloy steel	1.0D	D<1:0.15D D≥1:0.25D	Vc	40	65	70	65	60
					fz	0.002	0.003	0.004	0.005	0.006
					RPM	31831	25863	22282	17242	12732
	8-9	Low alloy steel	1.0D	D<1:0.15D D≥1:0.25D	Vc	40	65	70	65	60
					fz	0.002	0.003	0.004	0.005	0.006
					RPM	31831	25863	22282	17242	12732
	11.1 11.2	High alloyed steel, and tool steel	1.0D	D<1:0.15D D≥1:0.25D	Vc	40	65	70	65	60
					fz	0.002	0.003	0.004	0.005	0.006
					RPM	31831	25863	22282	17242	12732
H	38.1 38.2	Hardened steel	1.0D	D<1:0.02D D≥1:0.05D	Vc	30	50	50	50	45
					fz	0.001	0.002	0.003	0.003	0.004
					RPM	23873	19894	15915	13263	9549
	40	Chilled Cast Iron	1.0D	D<1:0.15D D≥1:0.25D	Vc	40	65	70	65	60
					fz	0.002	0.003	0.004	0.005	0.006
					RPM	31831	25863	22282	17242	12732
	41	Hardened Cast Iron	1.0D	D<1:0.02D D≥1:0.05D	Vc	30	50	50	50	45
					fz	0.001	0.002	0.003	0.003	0.004
					RPM	23873	19894	15915	13263	9549

ISO	VDI 3323	Material Description	Ae	Ap	Parameter	Diameter (∅)									
						2.0	3.0	4.0	5.0	6.0	8.0	10.0	12.0	16.0	20.0
P	1-4	Non-alloy steel	1.0D	D≤3:0.2D D>3:0.5D	Vc	65	75	85	90	95	95	90	95	100	95
					fz	0.01	0.015	0.025	0.032	0.039	0.057	0.064	0.064	0.062	0.063
					RPM	10345	7958	6764	5730	5040	3780	2865	2520	1989	1512
					FEED	207	239	338	367	393	431	367	323	247	191
					Vc	45	45	50	55	55	55	55	55	60	60
					fz	0.010	0.016	0.024	0.032	0.041	0.050	0.050	0.048	0.051	0.047
	5	Low alloy steel	1.0D	D≤3:0.2D D>3:0.5D	Vc	65	75	85	90	95	95	90	95	100	95
					fz	0.01	0.015	0.025	0.032	0.039	0.057	0.064	0.064	0.062	0.063
					RPM	10345	7958	6764	5730	5040	3780	2865	2520	1989	1512
					FEED	207	239	338	367	393	431	367	323	247	191
					Vc	45	45	50	55	55	55	55	55	60	60
					fz	0.010	0.016	0.024	0.032	0.041	0.050	0.050	0.048	0.051	0.047
	6-7	High alloyed steel, and tool steel	1.0D	D≤3:0.2D D>3:0.5D	Vc	65	75	85	90	95	95	90	95	100	95
					fz	0.01	0.015	0.025	0.032	0.039	0.057	0.064	0.064	0.062	0.063
					RPM	10345	7958	6764	5730	5040	3780	2865	2520	1989	1512
					FEED	207	239	338	367	393	431	367	323	247	191
					Vc	45	45	50	55	55	55	55	55	60	60
					fz	0.010	0.016	0.024	0.032	0.041	0.050	0.050	0.048	0.051	0.047
8-9	Stainless steel	1.0D	D≤3:0.2D D>3:0.5D	Vc	65	75	85	90	95	95	90	95	100	95	
				fz	0.01	0.015	0.025	0.032	0.039	0.057	0.064	0.064	0.062	0.063	
				RPM	10345	7958	6764	5730	5040	3780	2865	2520	1989	1512	
				FEED	207	239	338	367	393	431	367	323	247	191	
				Vc	45	45	50	55	55	55	55	55	60	60	
				fz	0.010	0.016	0.024	0.032	0.041	0.050	0.050	0.048	0.051	0.047	
10	Grey cast iron Nodular cast iron Malleable cast iron	1.0D	D≤3:0.2D D>3:0.5D	Vc	65	75	85	90	95	95	90	95	100	95	
				fz	0.01	0.015	0.025	0.032	0.039	0.057	0.064	0.064	0.062	0.063	
				RPM	10345	7958	6764	5730	5040	3780	2865	2520	1989	1512	
				FEED	207	239	338	367	393	431	367	323	247	191	
				Vc	45	45	50	55	55	55	55	55	60	60	
				fz	0.010	0.016	0.024	0.032	0.041	0.050	0.050	0.048	0.051	0.047	
11.1 11.2	Hardened steel	1.0D	D≤3:0.2D D>3:0.5D	Vc	35	40	45	45	50	45	45	45	50	45	
				fz	0.009	0.016	0.024	0.032	0.039	0.053	0.06	0.059	0.066	0.06	
				RPM	5570	4244	3581	2865	2653	1790	1432	1194	995	716	
				FEED	100	136	172	183	207	190	172	141	131	86	
				Vc	65	75	85	90	95	95	90	95	100	95	
				fz	0.01	0.015	0.025	0.032	0.039	0.057	0.064	0.064	0.062	0.063	
H	38.1 38.2	Chilled Cast Iron	1.0D	D≤3:0.2D D>3:0.5D	Vc	65	75	85	90	95	95	90	95	100	95
					fz	0.01	0.015	0.025	0.032	0.039	0.057	0.064	0.064	0.062	0.063
					RPM	10345	7958	6764	5730	5040	3780	2865	2520	1989	1512
					FEED	207	239	338	367	393	431	367	323	247	191
					Vc	30	30	35	35	35	40	40	40	40	40
					fz	0.004	0.007	0.009	0.013	0.017	0.028	0.027	0.029	0.028	0.028
	40	Hardened Cast Iron	1.0D	D≤3:0.2D D>3:0.5D	Vc	30	30	35	35	35	40	40	40	40	40
					fz	0.004	0.007	0.009	0.013	0.017	0.028	0.027	0.029	0.028	0.028
					RPM	4775	3183	2785	2228	1857	1592	1273	1061	796	637
					FEED	38	45	50	58	63	89	69	62	45	36
					Vc	45	45	50	55	55	55	55	55	60	60
					fz	0.01	0.016	0.024	0.032	0.041	0.05	0.05	0.048	0.051	0.047
	41	General HSS End Mills	1.0D	D≤3:0.2D D>3:0.5D	Vc	30	30	35	35	35	40	40	40	40	40
					fz	0.004	0.007	0.009	0.013	0.017	0.028	0.027	0.029	0.028	0.028
					RPM	4775	3183	2785	2228	1857	1592	1273	1061	796	637
					FEED	38	45	50	58	63	89	69	62	45	36
					Vc	45	45	50	55	55	55	55	55	60	60
					fz	0.01	0.016	0.024	0.032	0.041	0.05	0.05	0.048	0.051	0.047

GM883 SERIES

2 FLUTE RIB PROCESSING

Vc = m/min.
fz = mm/tooth
RPM = rev./min.
FEED = mm/min.
Ap = mm

ISO	VDI 3323	Material Description	Parameter	Diameter (Ø)							
				0.4	0.5	0.6	0.7	0.8	0.9	1.0	1.2
P	1-4	Non-alloy steel	Vc	39~50	49~63	58~75	68~88	68~88	71~89	71~88	70~85
			fz	0.003~0.006	0.003~0.006	0.004~0.007	0.004~0.007	0.005~0.009	0.006~0.011	0.006~0.014	0.008~0.020
			RPM	32550~42000	32550~42000	32550~42000	32550~42000	28350~36750	26250~33080	23630~29400	19430~23630
			FEED	210~460	210~460	265~600	265~600	295~660	295~755	295~850	295~945
			Ap	0.007~0.018	0.009~0.022	0.011~0.026	0.012~0.031	0.014~0.035	0.030~0.060	0.045~0.090	0.055~0.100
			Vc	28~35	35~44	42~53	49~62	49~62	49~64	49~63	49~62
	5	Non-alloy steel	fz	0.002~0.006	0.002~0.006	0.002~0.008	0.002~0.008	0.003~0.010	0.005~0.012	0.006~0.015	0.007~0.018
			RPM	23630~29400	23630~29400	23630~29400	23630~29400	20480~25730	18380~23630	16490~21000	13650~17330
			FEED	90~355	90~355	115~450	115~450	125~505	170~565	200~630	200~630
			Ap	0.007~0.018	0.009~0.022	0.011~0.026	0.012~0.031	0.014~0.035	0.030~0.060	0.045~0.090	0.055~0.100
			Vc	39~50	49~63	58~75	68~88	68~88	71~89	71~88	70~85
			fz	0.003~0.006	0.003~0.006	0.004~0.007	0.004~0.007	0.005~0.009	0.006~0.011	0.006~0.014	0.008~0.020
6-7	Low alloy steel	RPM	32550~42000	32550~42000	32550~42000	32550~42000	28350~36750	26250~33080	23630~29400	19430~23630	
		FEED	210~460	210~460	265~600	265~600	295~660	295~755	295~850	295~945	
		Ap	0.007~0.018	0.009~0.022	0.011~0.026	0.012~0.031	0.014~0.035	0.030~0.060	0.045~0.090	0.055~0.100	
		Vc	28~35	35~44	42~53	49~62	49~62	49~64	49~63	49~62	
		fz	0.002~0.006	0.002~0.006	0.002~0.008	0.002~0.008	0.003~0.010	0.005~0.012	0.006~0.015	0.007~0.018	
		RPM	23630~29400	23630~29400	23630~29400	23630~29400	20480~25730	18380~23630	16490~21000	13650~17330	
8-9	Low alloy steel	FEED	90~355	90~355	115~450	115~450	125~505	170~565	200~630	200~630	
		Ap	0.007~0.018	0.009~0.022	0.011~0.026	0.012~0.031	0.014~0.035	0.030~0.060	0.045~0.090	0.055~0.100	
		Vc	39~50	49~63	58~75	68~88	68~88	71~89	71~88	70~85	
		fz	0.003~0.006	0.003~0.006	0.004~0.007	0.004~0.007	0.005~0.009	0.006~0.011	0.006~0.014	0.008~0.020	
		RPM	32550~42000	32550~42000	32550~42000	32550~42000	28350~36750	26250~33080	23630~29400	19430~23630	
		FEED	210~460	210~460	265~600	265~600	295~660	295~755	295~850	295~945	
10	High alloyed steel, and tool steel	Ap	0.007~0.018	0.009~0.022	0.011~0.026	0.012~0.031	0.014~0.035	0.030~0.060	0.045~0.090	0.055~0.100	
		Vc	28~35	35~44	42~53	49~62	49~62	49~64	49~63	49~62	
		fz	0.002~0.006	0.002~0.006	0.002~0.008	0.002~0.008	0.003~0.010	0.005~0.012	0.006~0.015	0.007~0.018	
		RPM	23630~29400	23630~29400	23630~29400	23630~29400	20480~25730	18380~23630	16490~21000	13650~17330	
		FEED	90~355	90~355	115~450	115~450	125~505	170~565	200~630	200~630	
		Ap	0.007~0.018	0.009~0.022	0.011~0.026	0.012~0.031	0.014~0.035	0.030~0.060	0.045~0.090	0.055~0.100	
11.1 11.2	High alloyed steel, and tool steel	Vc	39~50	49~63	58~75	68~88	68~88	71~89	71~88	70~85	
		fz	0.003~0.006	0.003~0.006	0.004~0.007	0.004~0.007	0.005~0.009	0.006~0.011	0.006~0.014	0.008~0.020	
		RPM	32550~42000	32550~42000	32550~42000	32550~42000	28350~36750	26250~33080	23630~29400	19430~23630	
		FEED	210~460	210~460	265~600	265~600	295~660	295~755	295~850	295~945	
		Ap	0.007~0.018	0.009~0.022	0.011~0.026	0.012~0.031	0.014~0.035	0.030~0.060	0.045~0.090	0.055~0.100	
		Vc	28~35	35~44	42~53	49~62	49~62	49~64	49~63	49~62	
K	15-20	Grey cast iron Nodular cast iron Malleable cast iron	fz	0.003~0.006	0.003~0.006	0.004~0.007	0.004~0.007	0.005~0.009	0.006~0.011	0.006~0.014	0.008~0.020
			RPM	32550~42000	32550~42000	32550~42000	32550~42000	28350~36750	26250~33080	23630~29400	19430~23630
			FEED	210~460	210~460	265~600	265~600	295~660	295~755	295~850	295~945
			Ap	0.007~0.018	0.009~0.022	0.011~0.026	0.012~0.031	0.014~0.035	0.030~0.060	0.045~0.090	0.055~0.100
			Vc	18~21	22~27	27~32	31~37	31~37	31~35	31~39	31~40
			fz	0.001~0.003	0.001~0.003	0.001~0.003	0.001~0.003	0.002~0.004	0.003~0.005	0.003~0.005	0.004~0.006
H	38.1 38.2	Hardened steel	RPM	15020~17850	15020~17850	15020~17850	15020~17850	13130~15540	11550~13130	10500~13130	8720~11030
			FEED	30~95	30~95	40~115	40~115	45~130	60~135	70~135	70~135
			Ap	0.004~0.008	0.004~0.009	0.005~0.011	0.006~0.013	0.007~0.015	0.008~0.016	0.009~0.018	0.010~0.022
			Vc	28~35	35~44	42~53	49~62	49~62	49~64	49~63	49~62
			fz	0.002~0.006	0.002~0.006	0.002~0.008	0.002~0.008	0.003~0.010	0.005~0.012	0.006~0.015	0.007~0.018
			RPM	23630~29400	23630~29400	23630~29400	23630~29400	20480~25730	18380~23630	16490~21000	13650~17330
ROUTERS	40	Chilled Cast Iron	FEED	90~355	90~355	115~450	115~450	125~505	170~565	200~630	200~630
			Ap	0.007~0.018	0.009~0.022	0.011~0.026	0.012~0.031	0.014~0.035	0.030~0.060	0.045~0.090	0.055~0.100
			Vc	18~21	22~27	27~32	31~37	31~37	31~35	31~39	31~40
			fz	0.001~0.003	0.001~0.003	0.001~0.003	0.001~0.003	0.002~0.004	0.003~0.005	0.003~0.005	0.004~0.006
			RPM	15020~17850	15020~17850	15020~17850	15020~17850	13130~15540	11550~13130	10500~13130	8720~11030
			FEED	30~95	30~95	40~115	40~115	45~130	60~135	70~135	70~135
CRX S END MILLS	41	Hardened Cast Iron	Ap	0.004~0.008	0.004~0.009	0.005~0.011	0.006~0.013	0.007~0.015	0.008~0.016	0.009~0.018	0.010~0.022

▶ NEXT PAGE

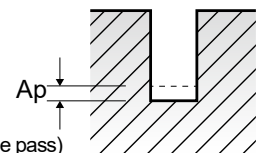

GM883 SERIES 2 FLUTE RIB PROCESSING

Vc = m/min.
fz = mm/tooth
RPM = rev./min.
FEED = mm/min.
Ap = mm

VDI 3323	Parameter	1.4	1.5	1.6	1.8	2.0	2.5	3.0	4.0	5.0	6.0
1-4	Vc	70~88	68~87	70~90	74~93	75~91	75~94	75~94	75~94	75~94	75~94
	fz	0.009~0.023	0.010~0.024	0.010~0.025	0.011~0.027	0.012~0.031	0.015~0.038	0.018~0.045	0.023~0.060	0.029~0.075	0.035~0.090
	RPM	16800~21000	15230~19430	14700~18900	13650~17330	12600~15230	9980~12600	8400~10500	6300~7880	5040~6300	4200~5250
	FEED	295~945	295~945	295~945	295~945	295~945	295~945	295~945	295~945	295~945	295~945
5	Ap	0.062~0.125	0.070~0.135	0.075~0.145	0.080~0.160	0.090~0.180	0.112~0.235	0.135~0.270	0.180~0.360	0.225~0.450	0.270~0.540
	Vc	51~62	49~64	51~64	52~65	52~66	53~67	52~66	52~67	52~66	53~66
	fz	0.008~0.021	0.009~0.022	0.009~0.023	0.010~0.026	0.011~0.029	0.014~0.035	0.017~0.043	0.023~0.057	0.029~0.071	0.034~0.086
	RPM	12080~14700	11030~14180	10710~13440	9660~12080	8720~11030	7040~8930	5780~7350	4310~5570	3470~4410	2940~3680
6-7	FEED	200~630	200~630	200~630	200~630	200~630	200~630	200~630	200~630	200~630	200~630
	Ap	0.062~0.125	0.070~0.135	0.075~0.145	0.080~0.160	0.090~0.180	0.112~0.235	0.135~0.270	0.180~0.360	0.225~0.450	0.270~0.540
	Vc	70~88	68~87	70~90	74~93	75~91	75~94	75~94	75~94	75~94	75~94
	fz	0.009~0.023	0.010~0.024	0.010~0.025	0.011~0.027	0.012~0.031	0.015~0.038	0.018~0.045	0.023~0.060	0.029~0.075	0.035~0.090
8-9	RPM	16800~21000	15230~19430	14700~18900	13650~17330	12600~15230	9980~12600	8400~10500	6300~7880	5040~6300	4200~5250
	FEED	295~945	295~945	295~945	295~945	295~945	295~945	295~945	295~945	295~945	295~945
	Ap	0.062~0.125	0.070~0.135	0.075~0.145	0.080~0.160	0.090~0.180	0.112~0.235	0.135~0.270	0.180~0.360	0.225~0.450	0.270~0.540
	Vc	51~62	49~64	51~64	52~65	52~66	53~67	52~66	52~67	52~66	53~66
10	fz	0.008~0.021	0.009~0.022	0.009~0.023	0.010~0.026	0.011~0.029	0.014~0.035	0.017~0.043	0.023~0.057	0.029~0.071	0.034~0.086
	RPM	12080~14700	11030~14180	10710~13440	9660~12080	8720~11030	7040~8930	5780~7350	4310~5570	3470~4410	2940~3680
	FEED	200~630	200~630	200~630	200~630	200~630	200~630	200~630	200~630	200~630	200~630
	Ap	0.062~0.125	0.070~0.135	0.075~0.145	0.080~0.160	0.090~0.180	0.112~0.235	0.135~0.270	0.180~0.360	0.225~0.450	0.270~0.540
11.1 - 11.2	Vc	70~88	68~87	70~90	74~93	75~91	75~94	75~94	75~94	75~94	75~94
	fz	0.009~0.023	0.010~0.024	0.010~0.025	0.011~0.027	0.012~0.031	0.015~0.038	0.018~0.045	0.023~0.060	0.029~0.075	0.035~0.090
	RPM	16800~21000	15230~19430	14700~18900	13650~17330	12600~15230	9980~12600	8400~10500	6300~7880	5040~6300	4200~5250
	FEED	295~945	295~945	295~945	295~945	295~945	295~945	295~945	295~945	295~945	295~945
15 - 20	Ap	0.062~0.125	0.070~0.135	0.075~0.145	0.080~0.160	0.090~0.180	0.112~0.235	0.135~0.270	0.180~0.360	0.225~0.450	0.270~0.540
	Vc	32~40	32~39	32~40	32~41	33~41	34~42	33~41	33~41	33~41	33~49
	fz	0.005~0.007	0.005~0.008	0.005~0.008	0.006~0.009	0.006~0.010	0.008~0.012	0.009~0.015	0.013~0.020	0.015~0.025	0.019~0.025
	RPM	7560~9450	7040~8610	6720~8400	5990~7560	5570~6930	4520~5570	3680~4620	2730~3470	2210~2730	1840~2730
38.1 - 38.2	FEED	70~135	70~135	70~135	70~135	70~135	70~135	70~135	70~135	70~135	70~135
	Ap	0.012~0.025	0.014~0.028	0.015~0.030	0.016~0.032	0.018~0.035	0.022~0.045	0.028~0.055	0.036~0.072	0.045~0.090	0.054~0.108
	Vc	51~62	49~64	51~64	52~65	52~66	53~67	52~66	52~67	52~66	53~66
	fz	0.008~0.021	0.009~0.022	0.009~0.023	0.010~0.026	0.011~0.029	0.014~0.035	0.017~0.043	0.023~0.057	0.029~0.071	0.034~0.086
40	RPM	12080~14700	11030~14180	10710~13440	9660~12080	8720~11030	7040~8930	5780~7350	4310~5570	3470~4410	2940~3680
	FEED	200~630	200~630	200~630	200~630	200~630	200~630	200~630	200~630	200~630	200~630
	Ap	0.062~0.125	0.070~0.135	0.075~0.145	0.080~0.160	0.090~0.180	0.112~0.235	0.135~0.270	0.180~0.360	0.225~0.450	0.270~0.540
	Vc	32~40	32~39	32~40	32~41	33~41	34~42	33~41	33~41	33~41	33~49
41	fz	0.005~0.007	0.005~0.008	0.005~0.008	0.006~0.009	0.006~0.010	0.008~0.012	0.009~0.015	0.013~0.020	0.015~0.025	0.019~0.025
	RPM	7560~9450	7040~8610	6720~8400	5990~7560	5570~6930	4520~5570	3680~4620	2730~3470	2210~2730	1840~2730
	FEED	70~135	70~135	70~135	70~135	70~135	70~135	70~135	70~135	70~135	70~135
	Ap	0.012~0.025	0.014~0.028	0.015~0.030	0.016~0.032	0.018~0.035	0.022~0.045	0.028~0.055	0.036~0.072	0.045~0.090	0.054~0.108

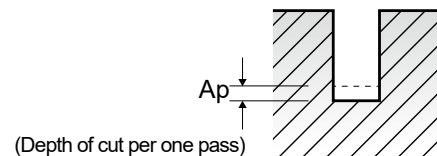



GM895 SERIES

3 FLUTE - SLOTTING

Vc = m/min.
fz = mm/tooth
RPM = rev./min.
FEED = mm/min.

ISO	VDI 3323	Material Description	Ae	Ap	Parameter	Diameter (Ø)									
						2.0	3.0	4.0	5.0	6.0	8.0	10.0	12.0	16.0	
P	1-4	Non-alloy steel	1.0D	D≤3:0.2D D>3:0.5D	Vc	80	90	105	110	115	115	115	115	120	
					fz	0.005	0.007	0.012	0.015	0.019	0.027	0.031	0.03	0.03	
	RPM		12732	9549	8356	7003	6101	4576	3661	3050	2387				
	FEED		191	201	301	315	348	371	340	275	215				
	5	Non-alloy steel	1.0D	D≤3:0.2D D>3:0.5D	Vc	50	60	65	65	70	70	70	70	75	
					fz	0.005	0.008	0.011	0.015	0.020	0.024	0.023	0.023	0.024	
	RPM		7958	6366	5173	4138	3714	2785	2228	1857	1492				
	FEED		119	153	171	186	223	201	154	128	107				
	6-7	Low alloy steel	1.0D	D≤3:0.2D D>3:0.5D	Vc	80	90	105	110	115	115	115	115	120	
					fz	0.005	0.007	0.012	0.015	0.019	0.027	0.031	0.03	0.03	
RPM	12732		9549	8356	7003	6101	4576	3661	3050	2387					
FEED	191		201	301	315	348	371	340	275	215					
8-9	Low alloy steel	1.0D	D≤3:0.2D D>3:0.5D	Vc	50	60	65	65	70	70	70	70	75		
				fz	0.005	0.008	0.011	0.015	0.020	0.024	0.023	0.023	0.024		
RPM		7958	6366	5173	4138	3714	2785	2228	1857	1492					
FEED		119	153	171	186	223	201	154	128	107					
10	High alloyed steel, and tool steel	1.0D	D≤3:0.2D D>3:0.5D	Vc	80	90	105	110	115	115	115	115	120		
				fz	0.005	0.007	0.012	0.015	0.019	0.027	0.031	0.03	0.03		
RPM		12732	9549	8356	7003	6101	4576	3661	3050	2387					
FEED		191	201	301	315	348	371	340	275	215					
11.1 - 11.2	High alloyed steel, and tool steel	1.0D	D≤3:0.2D D>3:0.5D	Vc	50	60	65	65	70	70	70	70	75		
				fz	0.005	0.008	0.011	0.015	0.020	0.024	0.023	0.023	0.024		
RPM		7958	6366	5173	4138	3714	2785	2228	1857	1492					
FEED		119	153	171	186	223	201	154	128	107					
M	14.1	Stainless steel	1.0D	D≤3:0.2D D>3:0.5D	Vc	45	50	55	55	60	60	60	55	60	
K	15-20	Grey cast iron Nodular cast iron Malleable cast iron	1.0D	D≤3:0.2D D>3:0.5D	fz	0.005	0.007	0.012	0.015	0.019	0.027	0.031	0.03	0.03	
					RPM	12732	9549	8356	7003	6101	4576	3661	3050	2387	
					FEED	191	201	301	315	348	371	340	275	215	
					Vc	80	90	105	110	115	115	115	115	120	
H	38.1 - 38.2	Hardened steel	1.0D	0.05D	Vc	35	35	40	40	40	45	45	50	50	
					fz	0.002	0.004	0.004	0.007	0.008	0.013	0.013	0.014	0.013	
					RPM	5570	3714	3183	2546	2122	1790	1432	1326	995	
					FEED	33	45	38	53	51	70	56	56	39	
H	40	Chilled Cast Iron	1.0D	D≤3:0.2D D>3:0.5D	Vc	50	60	65	65	70	70	70	70	75	
					fz	0.005	0.008	0.011	0.015	0.020	0.024	0.023	0.023	0.024	
					RPM	7958	6366	5173	4138	3714	2785	2228	1857	1492	
					FEED	119	153	171	186	223	201	154	128	107	
H	41	Hardened Cast Iron	1.0D	0.05D	Vc	35	35	40	40	40	45	45	50	50	
					fz	0.002	0.004	0.004	0.007	0.008	0.013	0.013	0.014	0.013	
					RPM	5570	3714	3183	2546	2122	1790	1432	1326	995	
					FEED	33	45	38	53	51	70	56	56	39	

▶ NEXT PAGE

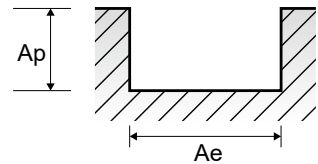

GM895 SERIES

3 FLUTE - SIDE CUTTING

Vc = m/min.
fz = mm/tooth
RPM = rev./min.
FEED = mm/min.

ISO	VDI 3323	Material Description	Ae	Ap	Parameter	Diameter (Ø)									
						2.0	3.0	4.0	5.0	6.0	8.0	10.0	12.0	16.0	
P	1-4	Non-alloy steel	0.05D	1.0D	Vc	80	90	105	110	115	115	115	115	120	
					fz	0.006	0.009	0.019	0.024	0.03	0.042	0.047	0.048	0.047	
					RPM	12732	9549	8356	7003	6101	4576	3661	3050	2387	
					FEED	229	258	476	504	549	577	516	439	337	
	5	Non-alloy steel	0.05D	1.0D	Vc	50	60	65	65	70	70	70	70	75	
					fz	0.006	0.009	0.019	0.024	0.031	0.039	0.039	0.038	0.037	
					RPM	7958	6366	5173	4138	3714	2785	2228	1857	1492	
					FEED	143	172	295	298	345	326	261	212	166	
	6-7	Low alloy steel	0.05D	1.0D	Vc	80	90	105	110	115	115	115	115	120	
					fz	0.006	0.009	0.019	0.024	0.03	0.042	0.047	0.048	0.047	
					RPM	12732	9549	8356	7003	6101	4576	3661	3050	2387	
					FEED	229	258	476	504	549	577	516	439	337	
8-9	Low alloy steel	0.05D	1.0D	Vc	50	60	65	65	70	70	70	70	75		
				fz	0.006	0.009	0.019	0.024	0.031	0.039	0.039	0.038	0.037		
				RPM	7958	6366	5173	4138	3714	2785	2228	1857	1492		
				FEED	143	172	295	298	345	326	261	212	166		
10	High alloyed steel, and tool steel	0.05D	1.0D	Vc	80	90	105	110	115	115	115	115	120		
				fz	0.006	0.009	0.019	0.024	0.03	0.042	0.047	0.048	0.047		
				RPM	12732	9549	8356	7003	6101	4576	3661	3050	2387		
				FEED	229	258	476	504	549	577	516	439	337		
11.1 11.2	High alloyed steel, and tool steel	0.05D	1.0D	Vc	50	60	65	65	70	70	70	70	75		
				fz	0.006	0.009	0.019	0.024	0.031	0.039	0.039	0.038	0.037		
				RPM	7958	6366	5173	4138	3714	2785	2228	1857	1492		
				FEED	143	172	295	298	345	326	261	212	166		
M	14.1	Stainless steel	0.05D	1.0D	Vc	45	50	55	55	60	60	60	55	60	
					fz	0.006	0.009	0.018	0.024	0.029	0.042	0.046	0.044	0.047	
					RPM	7162	5305	4377	3501	3183	2387	1910	1459	1194	
					FEED	129	143	236	252	277	301	264	193	168	
K	15-20	Grey cast iron Nodular cast iron Malleable cast iron	0.05D	1.0D	Vc	80	90	105	110	115	115	115	115	120	
					fz	0.006	0.009	0.019	0.024	0.03	0.042	0.047	0.048	0.047	
					RPM	12732	9549	8356	7003	6101	4576	3661	3050	2387	
					FEED	229	258	476	504	549	577	516	439	337	
H	38.1 - 38.2	Hardened steel	0.05D	1.0D	Vc	35	35	40	40	40	45	45	50	50	
					fz	0.002	0.004	0.005	0.008	0.010	0.016	0.017	0.017	0.017	
					RPM	5570	3714	3183	2546	2122	1790	1432	1326	995	
					FEED	33	45	48	61	64	86	73	68	51	
	40	Chilled Cast Iron	0.05D	1.0D	Vc	50	60	65	65	70	70	70	70	75	
					fz	0.006	0.009	0.019	0.024	0.031	0.039	0.039	0.038	0.037	
					RPM	7958	6366	5173	4138	3714	2785	2228	1857	1492	
					FEED	143	172	295	298	345	326	261	212	166	
	41	Hardened Cast Iron	0.05D	1.0D	Vc	35	35	40	40	40	45	45	50	50	
					fz	0.002	0.004	0.005	0.008	0.010	0.016	0.017	0.017	0.017	
					RPM	5570	3714	3183	2546	2122	1790	1432	1326	995	
					FEED	33	45	48	61	64	86	73	68	51	

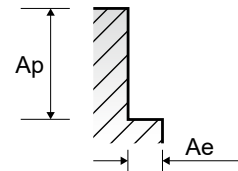

GM811 SERIES **4 FLUTE - SIDE CUTTING**

Vc = m/min.
fz = mm/tooth
RPM = rev./min.
FEED = mm/min.

ISO	VDI 3323	Material Description	Ae	Ap	Parameter	Diameter (Ø)										
						2.0	3.0	4.0	5.0	6.0	8.0	10.0	12.0	16.0	20.0	25.0
P	1-4	Non-alloy steel	0.05D	1.0D	Vc	80	95	105	110	115	120	115	115	125	120	120
					fz	0.006	0.009	0.019	0.024	0.03	0.042	0.047	0.047	0.047	0.048	0.046
	5	Non-alloy steel	0.05D	1.0D	RPM	12732	10080	8356	7003	6101	4775	3661	3050	2487	1910	1528
					FEED	306	363	635	672	732	802	688	573	468	367	281
	6-7	Low alloy steel	0.05D	1.0D	Vc	55	60	65	65	70	70	70	70	75	75	75
					fz	0.006	0.009	0.019	0.024	0.031	0.038	0.037	0.037	0.037	0.038	0.039
	8-9	Low alloy steel	0.05D	1.0D	RPM	8754	6366	5173	4138	3714	2785	2228	1857	1492	1194	955
					FEED	210	229	393	397	460	423	330	275	221	181	149
	10	High alloyed steel, and tool steel	0.05D	1.0D	Vc	80	95	105	110	115	120	115	115	125	120	120
					fz	0.006	0.009	0.019	0.024	0.03	0.042	0.047	0.047	0.047	0.048	0.046
11.1-11.2	High alloyed steel, and tool steel	0.05D	1.0D	RPM	12732	10080	8356	7003	6101	4775	3661	3050	2487	1910	1528	
				FEED	306	363	635	672	732	802	688	573	468	367	281	
M	14.1	Stainless steel	0.05D	1.0D	Vc	55	60	65	65	70	70	70	70	75	75	75
					fz	0.006	0.009	0.019	0.024	0.031	0.038	0.037	0.037	0.037	0.038	0.039
K	15-20	Grey cast iron, Nodular cast iron, Malleable cast iron	0.05D	1.0D	RPM	8754	6366	5173	4138	3714	2785	2228	1857	1492	1194	955
					FEED	210	229	393	397	460	423	330	275	221	181	149
H	38.1-38.2	Hardened steel	0.05D	1.0D	Vc	45	50	55	55	60	60	60	55	60	60	60
					fz	0.005	0.009	0.018	0.024	0.029	0.041	0.045	0.044	0.046	0.045	0.044
H	40	Chilled Cast Iron	0.05D	1.0D	RPM	7162	5305	4377	3501	3183	2387	1910	1459	1194	955	764
					FEED	143	191	315	336	369	392	344	257	220	172	134
H	41	Hardened Cast Iron	0.05D	1.0D	Vc	80	95	105	110	115	120	115	115	125	120	120
					fz	0.006	0.009	0.019	0.024	0.03	0.042	0.047	0.047	0.047	0.048	0.046
R	41	Hardened Cast Iron	0.05D	1.0D	RPM	12732	10080	8356	7003	6101	4775	3661	3050	2487	1910	1528
					FEED	306	363	635	672	732	802	688	573	468	367	281
R	41	Hardened Cast Iron	0.05D	1.0D	Vc	35	35	40	40	40	45	50	50	50	50	45
					fz	0.002	0.004	0.005	0.008	0.010	0.017	0.016	0.017	0.016	0.015	0.015
R	41	Hardened Cast Iron	0.05D	1.0D	RPM	5570	3714	3183	2546	2122	1790	1592	1326	995	796	573
					FEED	45	59	64	81	85	122	102	90	64	48	34

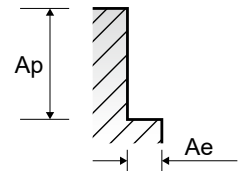

GM817 SERIES
4 FLUTE - SIDE CUTTING

Vc = m/min.
fz = mm/tooth
RPM = rev./min.
FEED = mm/min.

ISO	VDI 3323	Material Description	Ae	Ap	Parameter	Diameter (Ø)									
						2.0	3.0	4.0	5.0	6.0	8.0	10.0	12.0	16.0	20.0
P	1-4	Non-alloy steel	0.05D	2.5D	Vc	60	65	70	75	80	80	85	80	90	85
					fz	0.006	0.009	0.014	0.021	0.029	0.041	0.049	0.047	0.05	0.049
	RPM				9549	6897	5570	4775	4244	3183	2706	2122	1790	1353	
	FEED				229	248	312	401	492	522	530	399	358	265	
	Vc				35	40	40	45	45	45	50	50	50	50	
	fz				0.004	0.007	0.010	0.014	0.021	0.028	0.033	0.035	0.035	0.033	
	RPM	5570	4244	3183	2865	2387	1790	1592	1326	995	796				
	FEED	89	119	127	160	201	201	210	186	139	105				
	5	Low alloy steel	0.05D	2.5D	Vc	60	65	70	75	80	80	85	80	90	85
					fz	0.006	0.009	0.014	0.021	0.029	0.041	0.049	0.047	0.05	0.049
	RPM				9549	6897	5570	4775	4244	3183	2706	2122	1790	1353	
	FEED				229	248	312	401	492	522	530	399	358	265	
Vc	35				40	40	45	45	45	50	50	50	50		
fz	0.004				0.007	0.010	0.014	0.021	0.028	0.033	0.035	0.035	0.033		
RPM	5570	4244	3183	2865	2387	1790	1592	1326	995	796					
FEED	89	119	127	160	201	201	210	186	139	105					
6-7	High alloyed steel, and tool steel	0.05D	2.5D	Vc	60	65	70	75	80	80	85	80	90	85	
				fz	0.006	0.009	0.014	0.021	0.029	0.041	0.049	0.047	0.05	0.049	
RPM				9549	6897	5570	4775	4244	3183	2706	2122	1790	1353		
FEED				229	248	312	401	492	522	530	399	358	265		
Vc				35	40	40	45	45	45	50	50	50	50		
fz				0.004	0.007	0.010	0.014	0.021	0.028	0.033	0.035	0.035	0.033		
RPM	5570	4244	3183	2865	2387	1790	1592	1326	995	796					
FEED	89	119	127	160	201	201	210	186	139	105					
8-9	Grey cast iron Nodular cast iron Malleable cast iron	0.05D	2.5D	Vc	60	65	70	75	80	80	85	80	90	85	
				fz	0.006	0.009	0.014	0.021	0.029	0.041	0.049	0.047	0.05	0.049	
RPM				9549	6897	5570	4775	4244	3183	2706	2122	1790	1353		
FEED				229	248	312	401	492	522	530	399	358	265		
Vc				35	40	40	45	45	45	50	50	50	50		
fz				0.004	0.007	0.010	0.014	0.021	0.028	0.033	0.035	0.035	0.033		
RPM	5570	4244	3183	2865	2387	1790	1592	1326	995	796					
FEED	89	119	127	160	201	201	210	186	139	105					
10	Hardened steel	0.05D	2.5D	Vc	20	25	25	30	30	30	30	30	30	30	
				fz	0.004	0.006	0.008	0.011	0.016	0.021	0.027	0.026	0.026	0.027	
RPM				3183	2653	1989	1910	1592	1194	955	796	597	477		
FEED				51	64	64	84	102	100	103	83	62	52		
Vc				35	40	40	45	45	45	50	50	50	50		
fz				0.004	0.007	0.010	0.014	0.021	0.028	0.033	0.035	0.035	0.033		
RPM	5570	4244	3183	2865	2387	1790	1592	1326	995	796					
FEED	89	119	127	160	201	201	210	186	139	105					
11.1 11.2	Chilled Cast Iron	0.05D	2.5D	Vc	20	25	25	30	30	30	30	30	30	30	
				fz	0.004	0.006	0.008	0.011	0.016	0.021	0.027	0.026	0.026	0.027	
RPM				3183	2653	1989	1910	1592	1194	955	796	597	477		
FEED				51	64	64	84	102	100	103	83	62	52		
Vc				35	40	40	45	45	45	50	50	50	50		
fz				0.004	0.007	0.010	0.014	0.021	0.028	0.033	0.035	0.035	0.033		
RPM	5570	4244	3183	2865	2387	1790	1592	1326	995	796					
FEED	89	119	127	160	201	201	210	186	139	105					
K	Hardened Cast Iron	0.05D	2.5D	Vc	20	25	25	30	30	30	30	30	30	30	
				fz	0.004	0.006	0.008	0.011	0.016	0.021	0.027	0.026	0.026	0.027	
RPM				3183	2653	1989	1910	1592	1194	955	796	597	477		
FEED				51	64	64	84	102	100	103	83	62	52		
Vc				35	40	40	45	45	45	50	50	50	50		
fz				0.004	0.007	0.010	0.014	0.021	0.028	0.033	0.035	0.035	0.033		
RPM	5570	4244	3183	2865	2387	1790	1592	1326	995	796					
FEED	89	119	127	160	201	201	210	186	139	105					

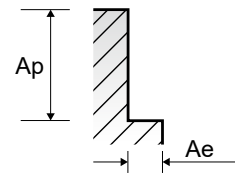

YG X-POWER PRO END MILLS

**RECOMMENDED CUTTING CONDITIONS
EMPFOHLENE SCHNEIDPARAMETER**

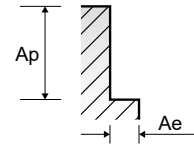

Vc = m/min.
fz = mm/tooth
RPM = rev./min.
FEED = mm/min.

GM812 SERIES

6&8 FLUTE - SIDE CUTTING

NORMAL SPEED

ISO	VDI 3323	Material Description	Ae	Ap	Parameter	Diameter (Ø)						
						6.0	8.0	10.0	12.0	16.0	20.0	
P	1-4	Non-alloy steel	0.1D	1.5D	Vc	105	110	110	110	110	105	
					fz	0.06	0.079	0.099	0.099	0.1	0.075	
						RPM	5570	4377	3501	2918	2188	1671
						FEED	2005	2075	2080	1733	1313	1003
		5	Non-alloy steel	0.05D	1.5D	Vc	75	75	75	75	75	75
	fz					0.059	0.078	0.098	0.097	0.099	0.075	
	RPM					3979	2984	2387	1989	1492	1194	
						FEED	1409	1397	1404	1158	886	716
		6-7	Low alloy steel	0.1D	1.5D	Vc	105	110	110	110	110	105
	fz					0.06	0.079	0.099	0.099	0.1	0.075	
RPM	5570					4377	3501	2918	2188	1671		
					FEED	2005	2075	2080	1733	1313	1003	
	8-9	Low alloy steel	0.05D	1.5D	Vc	75	75	75	75	75	75	
fz					0.059	0.078	0.098	0.097	0.099	0.075		
RPM					3979	2984	2387	1989	1492	1194		
					FEED	1409	1397	1404	1158	886	716	
	10	High alloyed steel, and tool steel	0.1D	1.5D	Vc	105	110	110	110	110	105	
fz					0.06	0.079	0.099	0.099	0.1	0.075		
RPM					5570	4377	3501	2918	2188	1671		
					FEED	2005	2075	2080	1733	1313	1003	
	11.1 - 11.2	High alloyed steel, and tool steel	0.05D	1.5D	Vc	75	75	75	75	75	75	
fz					0.059	0.078	0.098	0.097	0.099	0.075		
RPM					3979	2984	2387	1989	1492	1194		
					FEED	1409	1397	1404	1158	886	716	
H	38.1	Hardened steel	0.05D	1.5D	Vc	75	75	75	75	75	75	
					fz	0.059	0.078	0.098	0.097	0.099	0.075	
					RPM	3979	2984	2387	1989	1492	1194	
						FEED	1409	1397	1404	1158	886	716
		38.2	Hardened steel	0.05D	1.0D	Vc	30	30	30	30	35	30
	fz					0.022	0.030	0.035	0.036	0.035	0.027	
	RPM					1592	1194	955	796	696	477	
						FEED	210	215	201	172	146	103
		40	Chilled Cast Iron	0.05D	1.5D	Vc	75	75	75	75	75	75
	fz					0.059	0.078	0.098	0.097	0.099	0.075	
	RPM					3979	2984	2387	1989	1492	1194	
						FEED	1409	1397	1404	1158	886	716
		41	Hardened Cast Iron	0.05D	1.0D	Vc	30	30	30	30	35	30
	fz					0.022	0.030	0.035	0.036	0.035	0.027	
	RPM					1592	1194	955	796	696	477	
						FEED	210	215	201	172	146	103

HIGH SPEED

ISO	VDI 3323	Material Description	Ae	Ap	Parameter	Diameter (Ø)						
						6.0	8.0	10.0	12.0	16.0	20.0	
P	1-5	Non-alloy steel	0.05D	1.5D	Vc	325	325	320	325	325	325	
					fz	0.06	0.081	0.1	0.1	0.1	0.076	
					RPM	17242	12931	10186	8621	6466	5173	
						FEED	6207	6285	6112	5173	3879	3145
		6-9	Low alloy steel	0.05D	1.5D	Vc	325	325	320	325	325	325
	fz					0.06	0.081	0.1	0.1	0.1	0.076	
	RPM					17242	12931	10186	8621	6466	5173	
						FEED	6207	6285	6112	5173	3879	3145
		10 - 11.2	High alloyed steel, and tool steel	0.05D	1.5D	Vc	325	325	320	325	325	325
	fz					0.06	0.081	0.1	0.1	0.1	0.076	
	RPM					17242	12931	10186	8621	6466	5173	
						FEED	6207	6285	6112	5173	3879	3145
H	38.1	Hardened steel	0.05D	1.5D	Vc	325	325	320	325	325	325	
					fz	0.060	0.081	0.100	0.100	0.100	0.076	
					RPM	17242	12931	10186	8621	6466	5173	
						FEED	6207	6285	6112	5173	3879	3145
		38.2	Hardened steel	0.05D	1.0D	Vc	160	160	160	160	160	160
	fz					0.060	0.081	0.101	0.100	0.100	0.073	
	RPM					8488	6366	5093	4244	3183	2546	
						FEED	3056	3094	3086	2546	1910	1487
		40	Chilled Cast Iron	0.05D	1.5D	Vc	325	325	320	325	325	325
	fz					0.060	0.081	0.100	0.100	0.100	0.076	
	RPM					17242	12931	10186	8621	6466	5173	
						FEED	6207	6285	6112	5173	3879	3145
	41	Hardened Cast Iron	0.05D	1.0D	Vc	160	160	160	160	160	160	
fz					0.060	0.081	0.101	0.100	0.100	0.073		
RPM					8488	6366	5093	4244	3183	2546		
					FEED	3056	3094	3086	2546	1910	1487	

GM834 SERIES

6 FLUTE - SIDE CUTTING

Vc = m/min.
fz = mm/tooth
RPM = rev./min.
FEED = mm/min.

ISO	VDI 3323	Material Description	Ae	Ap	Parameter	Diameter (Ø)							
						6.0	8.0	10.0	12.0	16.0	20.0	25.0	
P	1-4	Non-alloy steel	0.01D	3.0D	Vc	45	45	45	45	45	45	45	
					fz	0.035	0.045	0.055	0.06	0.065	0.07	0.074	
	RPM		2387	1790	1432	1194	895	716	573				
	FEED		501	483	473	430	349	301	254				
	5		Non-alloy steel	0.01D	3.0D	Vc	30	30	30	30	30	30	30
						fz	0.035	0.044	0.050	0.053	0.061	0.067	0.071
	RPM	1592		1194	955	796	597	477	382				
	FEED	334		315	286	253	218	192	163				
	6-7	Low alloy steel		0.01D	3.0D	Vc	45	45	45	45	45	45	45
						fz	0.035	0.045	0.055	0.06	0.065	0.07	0.074
	RPM		2387	1790	1432	1194	895	716	573				
	FEED		501	483	473	430	349	301	254				
8-9	Low alloy steel		0.01D	3.0D	Vc	30	30	30	30	30	30	30	
					fz	0.035	0.044	0.050	0.053	0.061	0.067	0.071	
RPM		1592	1194	955	796	597	477	382					
FEED		334	315	286	253	218	192	163					
10		High alloyed steel, and tool steel	0.01D	3.0D	Vc	45	45	45	45	45	45	45	
					fz	0.035	0.045	0.055	0.06	0.065	0.07	0.074	
RPM	2387		1790	1432	1194	895	716	573					
FEED	501		483	473	430	349	301	254					
11.1 - 11.2	High alloyed steel, and tool steel		0.01D	3.0D	Vc	30	30	30	30	30	30	30	
					fz	0.035	0.044	0.050	0.053	0.061	0.067	0.071	
RPM		1592	1194	955	796	597	477	382					
FEED		334	315	286	253	218	192	163					
K		15-20	Grey cast iron Nodular cast iron Malleable cast iron	0.01D	3.0D	Vc	45	45	45	45	45	45	45
						fz	0.035	0.045	0.055	0.06	0.065	0.07	0.074
	RPM					2387	1790	1432	1194	895	716	573	
	FEED					501	483	473	430	349	301	254	
H	38.1 - 38.2	Hardened steel	0.005D	3.0D	Vc	25	25	25	25	25	25	25	
					fz	0.030	0.038	0.046	0.051	0.054	0.060	0.064	
					RPM	1326	995	796	663	497	398	318	
					FEED	239	227	220	203	161	143	122	
	40	Chilled Cast Iron	0.01D	3.0D	Vc	30	30	30	30	30	30	30	
					fz	0.035	0.044	0.050	0.053	0.061	0.067	0.071	
					RPM	1592	1194	955	796	597	477	382	
					FEED	334	315	286	253	218	192	163	
	41	Hardened Cast Iron	0.005D	3.0D	Vc	25	25	25	25	25	25	25	
					fz	0.030	0.038	0.046	0.051	0.054	0.060	0.064	
					RPM	1326	995	796	663	497	398	318	
					FEED	239	227	220	203	161	143	122	

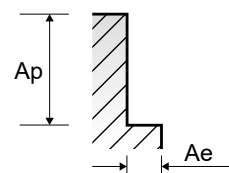

GM814 SERIES 3&4 FLUTE ROUGHING - SIDE CUTTING

Vc = m/min.
fz = mm/tooth
RPM = rev./min.
FEED = mm/min.

ISO	VDI 3323	Material Description	Ae	Ap	Parameter	Diameter (Ø)					
						6.0	8.0	10.0	12.0	16.0	20.0
P	1-4	Non-alloy steel	0.3D	1.5D	Vc	310	305	305	315	315	315
					fz	0.05	0.067	0.063	0.075	0.1	0.113
					RPM	16446	12136	9708	8356	6267	5013
					FEED	2467	2439	2447	2507	2507	2266
	5	Non-alloy steel	0.3D	1.5D	Vc	245	245	250	240	255	240
					fz	0.023	0.030	0.028	0.033	0.040	0.039
					RPM	12998	9748	7958	6366	5073	3820
					FEED	897	877	891	840	812	596
	6-7	Low alloy steel	0.3D	1.5D	Vc	310	305	305	315	315	315
					fz	0.05	0.067	0.063	0.075	0.1	0.113
					RPM	16446	12136	9708	8356	6267	5013
					FEED	2467	2439	2447	2507	2507	2266
8-9	Low alloy steel	0.3D	1.5D	Vc	245	245	250	240	255	240	
				fz	0.023	0.030	0.028	0.033	0.040	0.039	
				RPM	12998	9748	7958	6366	5073	3820	
				FEED	897	877	891	840	812	596	
10	High alloyed steel, and tool steel	0.3D	1.5D	Vc	310	305	305	315	315	315	
				fz	0.05	0.067	0.063	0.075	0.1	0.113	
				RPM	16446	12136	9708	8356	6267	5013	
				FEED	2467	2439	2447	2507	2507	2266	
11.1 - 11.2	High alloyed steel, and tool steel	0.3D	1.5D	Vc	245	245	250	240	255	240	
				fz	0.023	0.030	0.028	0.033	0.040	0.039	
				RPM	12998	9748	7958	6366	5073	3820	
				FEED	897	877	891	840	812	596	
M	14.1	Stainless steel	0.3D	1.5D	Vc	165	165	170	165	175	160
K	15-20	Grey cast iron Nodular cast iron Malleable cast iron	0.3D	1.5D	fz	0.023	0.03	0.028	0.034	0.039	0.038
					RPM	8754	6565	5411	4377	3482	2546
					FEED	604	591	606	595	543	387
					Vc	310	305	305	315	315	315
H	38.1 - 38.2	Hardened steel	0.05D	1.0D	fz	0.05	0.067	0.063	0.075	0.1	0.113
					RPM	16446	12136	9708	8356	6267	5013
					FEED	2467	2439	2447	2507	2507	2266
					Vc	65	65	65	65	65	65
H	40	Chilled Cast Iron	0.3D	1.5D	fz	0.026	0.033	0.036	0.039	0.034	0.038
					RPM	3448	2586	2069	1724	1293	1035
					FEED	269	256	298	269	176	157
					Vc	245	245	250	240	255	240
H	41	Hardened Cast Iron	0.05D	1.0D	fz	0.023	0.030	0.028	0.033	0.040	0.039
					RPM	12998	9748	7958	6366	5073	3820
					FEED	897	877	891	840	812	596
					Vc	65	65	65	65	65	65
H	41	Hardened Cast Iron	0.05D	1.0D	fz	0.026	0.033	0.036	0.039	0.034	0.038
					RPM	3448	2586	2069	1724	1293	1035
					FEED	269	256	298	269	176	157
					Vc	65	65	65	65	65	65

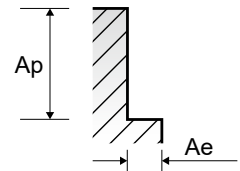



Leading Through Innovation

SOLID CARBIDE

TitaNox-POWER END MILLS

TitaNox-Power VHM - Schaftfräser

- High Speed Machining for Exotic Materials: Titanium, Inconel and Stainless Steels
- Hochgeschwindigkeitsbearbeitung von Sonderwerkstoffen: Titan, Inconel und rostfreie Stähle

SELECTION GUIDE



SERIES	GMG40 GMG41	GMG28 GMG29	GMG30 GMG31	GMG24 GMG25
FLUTE	4	5	5	5
HELIX ANGLE	43°/45°	43°/44°/45°	43°/44°/45°	43°/44°/45°
CUTTING EDGE SHAPE	CORNER RADIUS	CORNER RADIUS	CORNER RADIUS	SQUARE
SIZE MIN	D6.0	D6.0	D6.0	D6.0
SIZE MAX	D25.0	D25.0	D25.0	D25.0
PAGE	398	400	401	403

SOLID CARBIDE
TitaNox-POWER
END MILLS

High Speed Machining for Exotic Materials:
Titanium, Inconel and Stainless Steels

LONG LENGTH DOUBLE CORE	SHORT LENGTH	LONG LENGTH	SHORT LENGTH
Y-Coating	Y-Coating	Y-Coating	Y-Coating



Please visit globalyg1.com/mat for material search

◎ : Excellent ○ : Good

Recommended cutting conditions : P 406

ISO	VDI 3323	Material Description	Composition / Structure / Heat Treatment	HB	HRc					
P	1	Non-alloy steel	About 0.15% C Annealed	125		○	○	○	○	
	2		About 0.45% C Annealed	190	13	○	○	○	○	
	3		About 0.45% C Quenched & Tempered	250	25	○	○	○	○	
	4		About 0.75% C Annealed	270	28	○	○	○	○	
	5		About 0.75% C Quenched & Tempered	300	32	○	○	○	○	
	6	Low alloy steel	Annealed	180	10	○	○	○	○	
	7		Quenched & Tempered	275	29	○	○	○	○	
	8		Quenched & Tempered	300	32	○	○	○	○	
	9		Quenched & Tempered	350	38	○	○	○	○	
	10		High alloyed steel, and tool steel	Annealed	200	15	○	○	○	○
	11			Quenched & Tempered	325	35	○	○	○	○
M	12	Stainless steel	Ferritic / Martensitic Annealed	200	15	◎	◎	◎	◎	
	13		Martensitic Quenched & Tempered	240	23	◎	◎	◎	◎	
	14		Austenitic	180	10	◎	◎	◎	◎	
K	15	Grey cast iron	Pearlitic / ferritic	180	10	○	○	○	○	
	16		Pearlitic (Martensitic)	260	26	○	○	○	○	
	17	Nodular cast iron	Ferritic	160	3	○	○	○	○	
	18		Pearlitic	250	25	○	○	○	○	
	19		Ferritic	130		○	○	○	○	
20	Malleable cast iron	Pearlitic	230	21	○	○	○	○		
N	21	Aluminum-wrought alloy	Not Curable	60						
	22		Curable Hardened	100						
	23	Aluminum-cast, alloyed	≤ 12% Si, Not Curable	75						
	24		≤ 12% Si, Curable Hardened	90						
	25		> 12% Si, Not Curable	130						
	26		Cutting Alloys, PB>1%	110						
	27	Copper and Copper Alloys	CuZn, CuSnZn (Brass)	90						
	28		CuSn, lead-free copper and electrolytic copper	100						
	29	Non Metallic Materials	Duroplastic, Fiber Reinforced Plastic							
	30		Rubber, Wood, etc.							
S	31	Heat Resistant Super Alloys	Fe Based Annealed	200	15	○	○	○	○	
	32		Cured	280	30	○	○	○	○	
	33		Annealed	250	25	○	○	○	○	
	34		Ni or Co Based Cured	350	38	○	○	○	○	
	35		Cast	320	34	○	○	○	○	
	36	Titanium Alloys	Pure Titanium	400 Rm		◎	◎	◎	◎	
	37		Alpha + Beta Alloys Hardened	1050 Rm		◎	◎	◎	◎	
H	38	Hardened steel	Hardened	550	55					
	39		Hardened	630	60					
	40	Chilled Cast Iron	Cast	400	42					
	41	Hardened Cast Iron	Hardened	550	55					

GMG26	EHE54
GMG27	EHE55
5	5
43°/44°/45°	40°
SQUARE	ROUGHING CORNER RADIUS
D6.0	D6.0
D25.0	D25.0
404	405
LONG LENGTH	-
Y-Coating	TiAlN



○		1
○		2
○		3
○		4
○		5
○		6
○		7
○		8
○		9
○		10
○		11
◎	○	12
◎	○	13
◎	○	14
○		15
○		16
○		17
○		18
○		19
○		20
		21
		22
		23
		24
		25
		26
		27
		28
		29
		30
○	○	31
○	○	32
○	○	33
○	○	34
○	○	35
◎	◎	36
◎	◎	37
		38
		39
		40
		41

HSS

CBN
END MILLS

i-Xmill
END MILLS

i-SMART
MODULAR
END MILLS

X5070
END MILLS

4G MILL
END MILLS

X-POWER
PRO
END MILLS

**TitaNox-
POWER
END MILLS**

JET-POWER
END MILLS

V7 PLUS
END MILLS

ALU-POWER
HPC
END MILLS

ALU-
POWER
END MILLS

D-POWER
GRAPHITE
END MILLS

D-POWER
CFRP
END MILLS

ROUTERS

CRX S
END MILLS

K-2
END MILLS

ONLY ONE
COATED PM60
END MILLS

TANK-
POWER
END MILLS

GENERAL
HSS
END MILLS

MILLING
CUTTERS

TECHNICAL
DATA

CARBIDE
HSS
CBN
i-Xmill
i-SMART
X5070
4G MILL
X-POWER
TitaNox-POWER
JET-POWER
V7 PLUS
ALU-POWER
ALU-POWER
D-POWER
D-POWER
ROUTERS
CRX S
K-2
ONLY ONE
TANK-POWER
GENERAL
MILLING
TECHNICAL DATA

TitaNox-POWER END MILLS

PLAIN SHANK **GMG40** SERIES
FLAT SHANK **GMG41** SERIES

CARBIDE, 4 FLUTE CORNER RADIUS with DOUBLE CORE

- VOLLHARTMETALL, 4 SCHNEIDEN ECKRADIUS mit DOPPELKERN**
- CARBURE, 4 DENTS, TORIQUE AVEC ÂME DOUBLE**
- FRESA IN MD, 4 TAGLIENTI, TORICA, DOUBLE CORE**

► Double core end mill has a unique flute design for excellent chip evacuation and higher rigidity.
► The double core adds stability and aids chip flow, reducing tool deflection, improving dimensional stability and workpiece accuracy.

► Der Doppelkern hat ein einzigartiges Schneiden Design für eine exzellente Spanabfuhr und bessere Zähigkeit.
► Der Doppelkern erhöht die Stabilität und unterstützt den Spänefluss, reduziert die Werkzeugabdrängung, verbessert die Formstabilität und die Werkstückgenauigkeit.

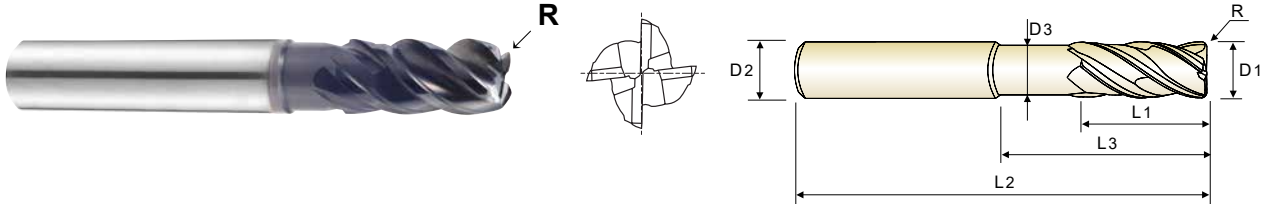

CARBIDE 4 43°/45° PLAIN FLAT P.406-407

Unit : mm

EDP No.		Corner Radius	Mill Diameter	Shank Diameter	Length of Cut	Length Below Shank	Overall Length	Neck Diameter
PLAIN	FLAT	R	D1	D2	L1	L3	L2	D3
GMG40060	GMG41060	R0.5	6.0	6	13	20	57	5.5
GMG40901	GMG41901	R1.0	6.0	6	13	20	57	5.5
GMG40080	GMG41080	R0.5	8.0	8	19	25	63	7.5
GMG40902	GMG41902	R1.0	8.0	8	19	25	63	7.5
GMG40903	GMG41903	R1.5	8.0	8	19	25	63	7.5
GMG40904	GMG41904	R2.0	8.0	8	19	25	63	7.5
GMG40100	GMG41100	R0.5	10.0	10	22	30	72	9.2
GMG40905	GMG41905	R1.0	10.0	10	22	30	72	9.2
GMG40906	GMG41906	R1.5	10.0	10	22	30	72	9.2
GMG40907	GMG41907	R2.0	10.0	10	22	30	72	9.2
GMG40120	GMG41120	R0.5	12.0	12	26	35	83	11.0
GMG40908	GMG41908	R1.0	12.0	12	26	35	83	11.0
GMG40909	GMG41909	R1.5	12.0	12	26	35	83	11.0
GMG40910	GMG41910	R2.0	12.0	12	26	35	83	11.0
GMG40911	GMG41911	R3.0	12.0	12	26	35	83	11.0
GMG40140	GMG41140	R1.0	14.0	14	26	35	83	13.0
GMG40912	GMG41912	R2.0	14.0	14	26	35	83	13.0
GMG40160	GMG41160	R1.0	16.0	16	35	43	92	15.0

Mill Dia. Tolerance (mm): 0 ~ -0.03
Shank Dia. Tolerance: h5
* Shank Dia. ≥ Ø12 : h6

◆ 2 STEP CORE

▶ NEXT PAGE

<SECTION X-X'>
EXCELLENT CHIP EVACUATION

<SECTION Y-Y'>
HIGHER RIGIDITY

◎ : Excellent ○ : Good

ISO Material Description	P											M					K				
	Non-alloy steel					Low alloy steel				High alloyed steel, and tool steel		Stainless steel					Grey cast iron		Nodular cast iron		Malleable cast iron
VDI 3323	1	2	3	4	5	6	7	8	9	10	11	12	13	14	15	16	17	18	19	20	
HRc		13	25	28	32	10	29	32	38	15	35	15	23	10	10	26	3	25		21	
HB	125	190	250	270	300	180	275	300	350	200	325	200	240	180	180	260	160	250	130	230	
Recommend	○	○	○	○	○	○	○	○	○	○	○	◎	◎	◎	○	○	○	○	○	○	
ISO Material Description	N										S							H			
	Aluminum-wrought alloy		Aluminum-cast, alloyed			Copper and Copper Alloys (Bronze / Brass)			Non Metallic Materials		Heat Resistant Super Alloys					Titanium Alloys		Hardened steel	Chilled Cast Iron	Hardened Cast Iron	
VDI 3323	21	22	23	24	25	26	27	28	29	30	31	32	33	34	35	36	37	38	39	40	41
HRc											15	30	25	38	34			55	60	42	55
HB	60	100	75	90	130	110	90	100			200	280	250	350	320	400 Rm	1050 Rm	550	630	400	550
Recommend											○	○	○	○	○	◎	◎				

CARBIDE, 4 FLUTE CORNER RADIUS with DOUBLE CORE

- **VOLLHARTMETALL, 4 SCHNEIDEN ECKRADIUS mit DOPPELKERN**
- **CARBURE, 4 DENTS, TORIQUE AVEC ÂME DOUBLE**
- **FRESA IN MD, 4 TAGLIENTI, TORICA, DOUBLE CORE**

▶ Double core end mill has a unique flute design for excellent chip evacuation and higher rigidity.
▶ The double core adds stability and aids chip flow, reducing tool deflection, improving dimensional stability and workpiece accuracy.

▶ Der Doppelkern hat ein einzigartiges Schneiden Design für eine exzellente Spanabfuhr und bessere Zähigkeit.
▶ Der Doppelkern erhöht die Stabilität und unterstützt den Spänefluss, reduziert die Werkzeugabdrängung, verbessert die Formstabilität und die Werkstückgenauigkeit.

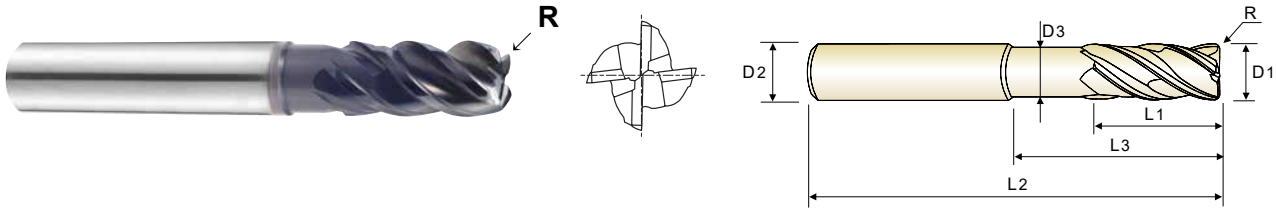

Unit : mm

EDP No.		Corner Radius	Mill Diameter	Shank Diameter	Length of Cut	Length Below Shank	Overall Length	Neck Diameter
PLAIN	FLAT	R	D1	D2	L1	L3	L2	D3
GMG40913	GMG41913	R1.5	16.0	16	35	43	92	15.0
GMG40914	GMG41914	R2.0	16.0	16	35	43	92	15.0
GMG40915	GMG41915	R3.0	16.0	16	35	43	92	15.0
GMG40916	GMG41916	R4.0	16.0	16	35	43	92	15.0
GMG40200	GMG41200	R1.0	20.0	20	44	56	110	19.0
GMG40917	GMG41917	R1.5	20.0	20	44	56	110	19.0
GMG40918	GMG41918	R2.0	20.0	20	44	56	110	19.0
GMG40919	GMG41919	R3.0	20.0	20	44	56	110	19.0
GMG40920	GMG41920	R3.5	20.0	20	44	56	110	19.0
GMG40921	GMG41921	R4.0	20.0	20	44	56	110	19.0
GMG40250	GMG41250	R1.0	25.0	25	55	70	130	24.0
GMG40922	GMG41922	R1.5	25.0	25	55	70	130	24.0
GMG40923	GMG41923	R2.0	25.0	25	55	70	130	24.0
GMG40924	GMG41924	R3.0	25.0	25	55	70	130	24.0
GMG40925	GMG41925	R4.0	25.0	25	55	70	130	24.0

Mill Dia. Tolerance (mm)	Shank Dia. Tolerance
0 ~ - 0.03	h5
	* Shank Dia. ≥ Ø12 : h6

◆ **2 STEP CORE**

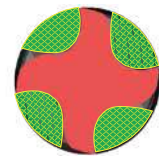
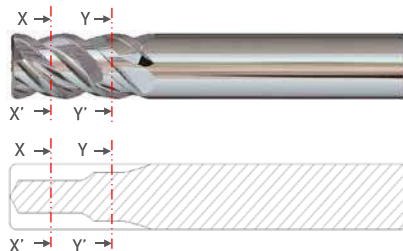

<SECTION X-X'>
EXCELLENT CHIP EVACUATION

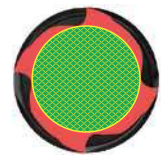

<SECTION Y-Y'>
HIGHER RIGIDITY

◎ : Excellent ○ : Good

ISO Material Description	P											M				K					
	Non-alloy steel					Low alloy steel						High alloyed steel, and tool steel				Stainless steel		Grey cast iron		Nodular cast iron	
VDI 3323	1	2	3	4	5	6	7	8	9	10	11	12	13	14	15	16	17	18	19	20	
HRc		13	25	28	32	10	29	32	38	15	35	15	23	10	10	26	3	25	42	21	
HB	125	190	250	270	300	180	275	300	350	200	325	200	240	180	180	260	160	250	130	230	
Recommend	○	○	○	○	○	○	○	○	○	○	○	◎	◎	◎	○	○	○	○	○	○	

ISO Material Description	N					S										H					
	Aluminum-wrought alloy		Aluminum-cast, alloyed			Copper and Copper Alloys (Bronze / Brass)			Non Metallic Materials		Heat Resistant Super Alloys					Titanium Alloys		Hardened steel	Chilled Cast Iron	Hardened Cast Iron	
VDI 3323	21	22	23	24	25	26	27	28	29	30	31	32	33	34	35	36	37	38	39	40	41
HRc											15	30	25	38	34	55	60	55	60	42	55
HB	60	100	75	90	130	110	90	100			200	280	250	350	320	400 Rm	1050 Rm	550	630	400	550
Recommend											○	○	○	○	○	◎	◎				

CARBIDE, 5 FLUTE CORNER RADIUS SHORT LENGTH

- **VOLLHARTMETALL, 5 SCHNEIDEN KURZ mit ECKRADIUS**
- **CARBURE, 5 DENTS, TORIQUE, SÉRIE COURTE**
- **FRESA IN MD, 5 TAGLIENTI, SERIE CORTA, TORICA**

- ▶ Excellent performance results and long tool life when machining Titanium and other tough materials.
- ▶ This tool has high rigidity of flute so that is possible to use for heavy profile and high speed milling.
- ▶ For protecting Corner chipping of end teeth, Corner Radius & Chamfer are adopted.
- ▶ Exzellente Leistungsergebnisse und hohe Standzeiten beim Bearbeiten von Titan oder anderen robusten Materialien.
- ▶ Die Schneiden des Werkzeugs haben eine besondere Festigkeit, so dass es für schwere Profile und zum High-Speed-Fräsen geeignet ist.
- ▶ Durch die Fäse und den Eckradius werden Ausbrüche verhindert.

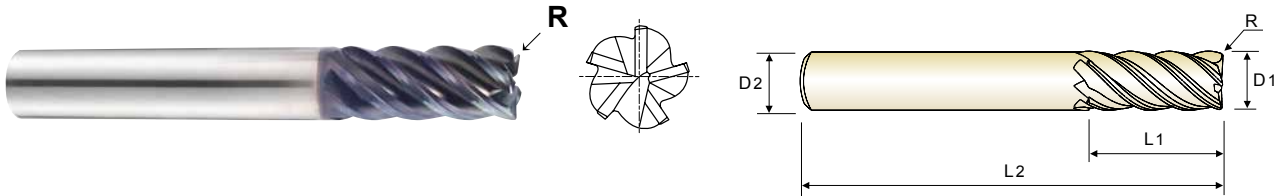

CARBIDE 5 43°/44°/45° PLAIN FLAT P.408

Unit : mm

EDP No.		Corner Radius	Mill Diameter	Shank Diameter	Length of Cut	Overall Length
PLAIN	FLAT	R	D1	D2	L1	L2
GMG28060	GMG29060	R0.5	6.0	6	10	54
GMG28080	GMG29080	R0.5	8.0	8	12	58
GMG28100	GMG29100	R0.5	10.0	10	14	66
GMG28120	GMG29120	R0.5	12.0	12	16	73
GMG28160	GMG29160	R1.0	16.0	16	22	82
GMG28200	GMG29200	R1.0	20.0	20	26	92
GMG28250	GMG29250	R1.0	25.0	25	29	100

Mill Dia. Tolerance (mm)	Shank Dia. Tolerance
0 ~ - 0.03	h5 * Shank Dia. ≥ Ø12 : h6

◎ : Excellent ○ : Good

ISO Material Description	P											M			K						
	Non-alloy steel					Low alloy steel						High alloyed steel, and tool steel			Stainless steel			Grey cast iron		Nodular cast iron	
VDI 3323	1	2	3	4	5	6	7	8	9	10	11	12	13	14	15	16	17	18	19	20	
HRc		13	25	28	32	10	29	32	38	15	35	15	23	10	10	26	3	25		21	
HB	125	190	250	270	300	180	275	300	350	200	325	200	240	180	180	260	160	250	130	230	
Recommend	○	○	○	○	○	○	○	○	○	○	○	◎	◎	◎	○	○	○	○	○	○	
ISO Material Description	N										S						H				
	Aluminum-wrought alloy		Aluminum-cast, alloyed			Copper and Copper Alloys (Bronze / Brass)			Non Metallic Materials		Heat Resistant Super Alloys						Titanium Alloys		Hardened steel	Chilled Cast Iron	Hardened Cast Iron
VDI 3323	21	22	23	24	25	26	27	28	29	30	31	32	33	34	35	36	37	38	39	40	41
HRc											15	30	25	38	34			55	60	42	55
HB	60	100	75	90	130	110	90	100			200	280	250	350	320	400 Rm	1050 Rm	550	630	400	550
Recommend											○	○	○	○	○	◎	◎				

CARBIDE, 5 FLUTE CORNER RADIUS LONG LENGTH

- VOLLHARTMETALL, 5 SCHNEIDEN LANG mit ECKRADIUS
- CARBURE, 5 DENTS, TORIQUE, SÉRIE LONGUE
- FRESA IN MD, 5 TAGLIENTI, SERIE LUNGA, TORICA

- ▶ Excellent performance results and long tool life when machining Titanium and other tough materials.
- ▶ This tool has high rigidity of flute so that is possible to use for heavy profile and high speed milling.
- ▶ For protecting Corner chipping of end teeth, Corner Radius & Chamfer are adopted.

- ▶ Exzellente Leistungsergebnisse und hohe Standzeiten beim Bearbeiten von Titan oder anderen robusten Materialien.
- ▶ Die Schneiden des Werkzeugs haben eine besondere Festigkeit, so dass es für schwere Profile und zum High-Speed-Fräsen geeignet ist.
- ▶ Durch die Fase und den Eckradius werden Ausbrüche verhindert.

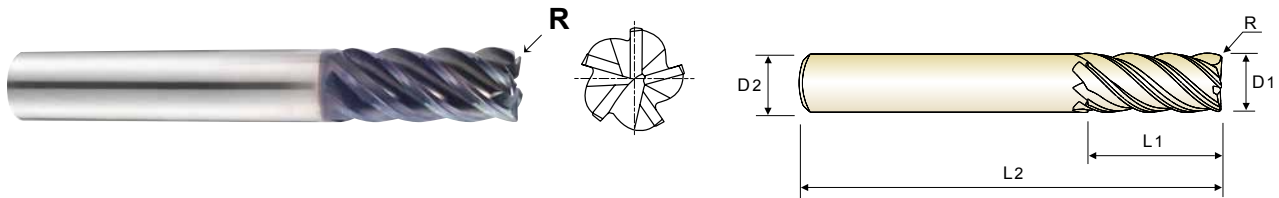

EDP No.		Corner Radius	Mill Diameter	Shank Diameter	Length of Cut	Overall Length
PLAIN	FLAT	R	D1	D2	L1	L2
GMG30060	GMG31060	R0.3	6.0	6	13	57
GMG30901	GMG31901	R0.5	6.0	6	13	57
GMG30902	GMG31902	R1.0	6.0	6	13	57
GMG30080	GMG31080	R0.5	8.0	8	19	63
GMG30903	GMG31903	R1.0	8.0	8	19	63
GMG30904	GMG31904	R1.5	8.0	8	19	63
GMG30905	GMG31905	R2.0	8.0	8	19	63
GMG30100	GMG31100	R0.5	10.0	10	22	72
GMG30906	GMG31906	R1.0	10.0	10	22	72
GMG30907	GMG31907	R1.5	10.0	10	22	72
GMG30908	GMG31908	R2.0	10.0	10	22	72
GMG30120	GMG31120	R0.5	12.0	12	26	83
GMG30909	GMG31909	R1.0	12.0	12	26	83
GMG30910	GMG31910	R1.5	12.0	12	26	83
GMG30911	GMG31911	R2.0	12.0	12	26	83
GMG30912	GMG31912	R2.5	12.0	12	26	83
GMG30913	GMG31913	R3.0	12.0	12	26	83
GMG30160	GMG31160	R1.0	16.0	16	36	92
GMG30914	GMG31914	R1.5	16.0	16	36	92
GMG30915	GMG31915	R2.0	16.0	16	36	92
GMG30916	GMG31916	R2.5	16.0	16	36	92
GMG30917	GMG31917	R3.0	16.0	16	36	92

Unit : mm

▶ NEXT PAGE

Mill Dia. Tolerance (mm)	Shank Dia. Tolerance
0 ~ - 0.03	h5 * Shank Dia. ≥ Ø12 : h6

ISO Material Description	P										M					K									
	Non-alloy steel					Low alloy steel					High alloyed steel, and tool steel					Stainless steel			Grey cast iron		Nodular cast iron		Malleable cast iron		
VDI 3323	1	2	3	4	5	6	7	8	9	10	11	12	13	14	15	16	17	18	19	20	21	22	23	24	25
HRC	125	190	250	270	300	180	275	300	350	200	325	200	240	180	180	260	160	250	130	230					
Recommend	○	○	○	○	○	○	○	○	○	○	○	○	○	○	○	○	○	○	○	○	○	○	○	○	○

ISO Material Description	N					S										H														
	Aluminum-wrought alloy		Aluminum-cast, alloyed		Copper and Copper Alloys (Bronze / Brass)	Non Metallic Materials	Heat Resistant Super Alloys					Titanium Alloys		Hardened steel	Chilled Cast Iron	Hardened Cast Iron														
VDI 3323	21	22	23	24	25	26	27	28	29	30	31	32	33	34	35	36	37	38	39	40	41	42	43	44	45	46	47	48	49	50
HRC	60	100	75	90	130	110	90	100			200	280	250	350	320	400 Rm	1050 Rm	550	630	400	550									
Recommend	○	○	○	○	○	○	○	○	○	○	○	○	○	○	○	○	○	○	○	○	○	○	○	○	○	○	○	○	○	○

◎ : Excellent ○ : Good

CARBIDE, 5 FLUTE CORNER RADIUS LONG LENGTH

- **VOLLHARTMETALL, 5 SCHNEIDEN LANG mit ECKRADIUS**
- **CARBURE, 5 DENTS, TORIQUE, SÉRIE LONGUE**
- **FRESA IN MD, 5 TAGLIENTI, SERIE LUNGA, TORICA**

- ▶ Excellent performance results and long tool life when machining Titanium and other tough materials.
- ▶ This tool has high rigidity of flute so that is possible to use for heavy profile and high speed milling.
- ▶ For protecting Corner chipping of end teeth, Corner Radius & Chamfer are adopted.
- ▶ Exzellente Leistungsergebnisse und hohe Standzeiten beim Bearbeiten von Titan oder anderen robusten Materialien.
- ▶ Die Schneiden des Werkzeugs haben eine besondere Festigkeit, so dass es für schwere Profile und zum High-Speed-Fräsen geeignet ist.
- ▶ Durch die Fäse und den Eckradius werden Ausbrüche verhindert.

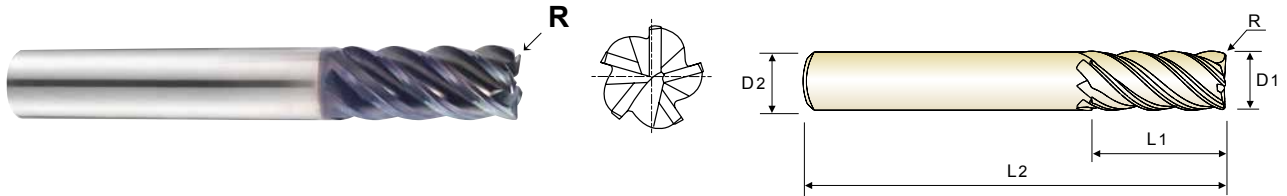

CARBIDE 5 43°/44°/45° PLAIN FLAT P.408

Unit : mm

EDP No.		Corner Radius	Mill Diameter	Shank Diameter	Length of Cut	Overall Length
PLAIN	FLAT	R	D1	D2	L1	L2
GMG30918	GMG31918	R4.0	16.0	16	36	92
GMG30200	GMG31200	R1.0	20.0	20	44	104
GMG30919	GMG31919	R1.5	20.0	20	44	104
GMG30920	GMG31920	R2.0	20.0	20	44	104
GMG30921	GMG31921	R2.5	20.0	20	44	104
GMG30922	GMG31922	R3.0	20.0	20	44	104
GMG30923	GMG31923	R4.0	20.0	20	44	104
GMG30924	GMG31924	R5.0	20.0	20	44	104
GMG30250	GMG31250	R1.0	25.0	25	54	121
GMG30925	GMG31925	R1.5	25.0	25	54	121
GMG30926	GMG31926	R2.0	25.0	25	54	121
GMG30927	GMG31927	R2.5	25.0	25	54	121
GMG30928	GMG31928	R3.0	25.0	25	54	121
GMG30929	GMG31929	R4.0	25.0	25	54	121
GMG30930	GMG31930	R5.0	25.0	25	54	121

Mill Dia. Tolerance (mm)	Shank Dia. Tolerance
0 ~ -0.03	h5 * Shank Dia. ≥ Ø12 : h6

◎ : Excellent ○ : Good

ISO Material Description	P										M					K						
	Non-alloy steel					Low alloy steel					High alloyed steel, and tool steel					Stainless steel			Grey cast iron		Nodular cast iron	
VDI 3323	1	2	3	4	5	6	7	8	9	10	11	12	13	14	15	16	17	18	19	20		
HRc		13	25	28	32	10	29	32	38	15	35	15	23	10	10	26	3	25		21		
HB	125	190	250	270	300	180	275	300	350	200	325	200	240	180	180	260	160	250	130	230		
Recommend	○	○	○	○	○	○	○	○	○	○	○	◎	◎	◎	○	○	○	○	○	○		
ISO Material Description	N										S							H				
	Aluminum-wrought alloy		Aluminum-cast, alloyed			Copper and Copper Alloys (Bronze / Brass)			Non Metallic Materials		Heat Resistant Super Alloys					Titanium Alloys		Hardened steel	Chilled Cast Iron	Hardened Cast Iron		
VDI 3323	21	22	23	24	25	26	27	28	29	30	31	32	33	34	35	36	37	38	39	40	41	
HRc											15	30	25	38	34			55	60	42	55	
HB	60	100	75	90	130	110	90	100			200	280	250	350	320	400 Rm	1050 Rm	550	630	400	550	
Recommend											○	○	○	○	○	◎	◎					

CARBIDE, 5 FLUTE SHORT LENGTH

- VOLLHARTMETALL, 5 SCHNEIDEN KURZ
- CARBURE, 5 DENTS, SÉRIE COURTE
- FRESA IN MD, 5 TAGLIENTI, SERIE CORTA

- ▶ Excellent performance results and long tool life when machining Titanium and other tough materials.
- ▶ This tool has high rigidity of flute so that is possible to use for heavy profile and high speed milling.
- ▶ For protecting Corner chipping of end teeth, Corner Radius & Chamfer are adopted.

- ▶ Exzellente Leistungsergebnisse und hohe Standzeiten beim Bearbeiten von Titan oder anderen robusten Materialien.
- ▶ Die Schneiden des Werkzeugs haben eine besondere Festigkeit, so dass es für schwere Profile und zum High-Speed-Fräsen geeignet ist.
- ▶ Durch die Fase und den Eckradius werden Ausbrüche verhindert.

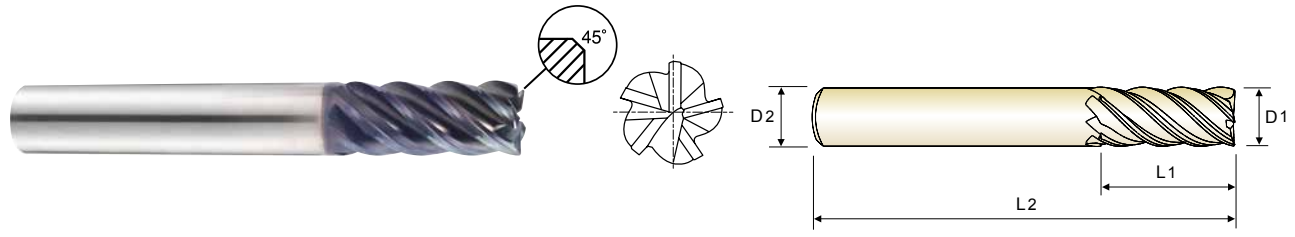

CARBIDE 5 43°/44°/45° PLAIN FLAT C x 45° P.409

Unit : mm

EDP No.		Mill Diameter	Shank Diameter	Length of Cut	Overall Length	Chamfer
PLAIN	FLAT	D1	D2	L1	L2	
GMG24060	GMG25060	6.0	6	10	54	0.20
GMG24080	GMG25080	8.0	8	12	58	0.20
GMG24100	GMG25100	10.0	10	14	66	0.30
GMG24120	GMG25120	12.0	12	16	73	0.35
GMG24160	GMG25160	16.0	16	22	82	0.40
GMG24200	GMG25200	20.0	20	26	92	0.50
GMG24250	GMG25250	25.0	25	29	100	0.50

Mill Dia. Tolerance (mm)	Shank Dia. Tolerance
0 ~ - 0.03	h5 * Shank Dia. ≥ Ø12 : h6

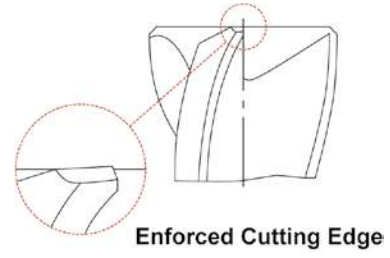

◎ : Excellent ○ : Good

ISO Material Description	P										M				K						
	Non-alloy steel					Low alloy steel					High alloyed steel, and tool steel				Stainless steel		Grey cast iron		Nodular cast iron		Malleable cast iron
VDI 3323	1	2	3	4	5	6	7	8	9	10	11	12	13	14	15	16	17	18	19	20	
HRC																					
HB	125	190	250	270	300	180	275	300	350	200	325	200	240	180	180	260	160	250	130	230	
Recommend	○	○	○	○	○	○	○	○	○	○	○	◎	◎	◎	○	○	○	○	○	○	
ISO Material Description	N					S										H					
	Aluminum-wrought alloy		Aluminum-cast, alloyed			Copper and Copper Alloys (Bronze / Brass)			Non Metallic Materials		Heat Resistant Super Alloys					Titanium Alloys		Hardened steel	Chilled Cast Iron	Hardened Cast Iron	
VDI 3323	21	22	23	24	25	26	27	28	29	30	31	32	33	34	35	36	37	38	39	40	41
HRC																					
HB	60	100	75	90	130	110	90	100			200	280	250	350	320	400 Rm	1050 Rm	550	630	400	550
Recommend											○	○	○	○	○	◎	◎				

CARBIDE, 5 FLUTE LONG LENGTH

- **VOLLHARTMETALL, 5 SCHNEIDEN LANG**
- **CARBURE, 5 DENTS, SÉRIE LONGUE**
- **FRESA IN MD, 5 TAGLIENTI, SERIE LUNGA**

- ▶ Suitable for Titanium, Titanium Alloys, Inconel and Stainless Steels.
- ▶ Optimized flute design for chip evacuation and rigidity when machining difficult-to-cut materials.
- ▶ Special roughing profile for machining Titanium and Titanium Alloys.
- ▶ Longer tool life with special coating.

- ▶ Einsetzbar für Titan, Titanlegierungen, Nickellegierungen und rostfreie Stähle.
- ▶ Verbessertes Schneidendesign für eine optimale Spanabfuhr und Stabilität beim Bearbeiten von schwer zerspanbaren Materialien.
- ▶ Spezielles Schruppprofil zum Bearbeiten von Titan und Titanlegierungen.
- ▶ Erhöhte Standzeit durch Spezialbeschichtung.

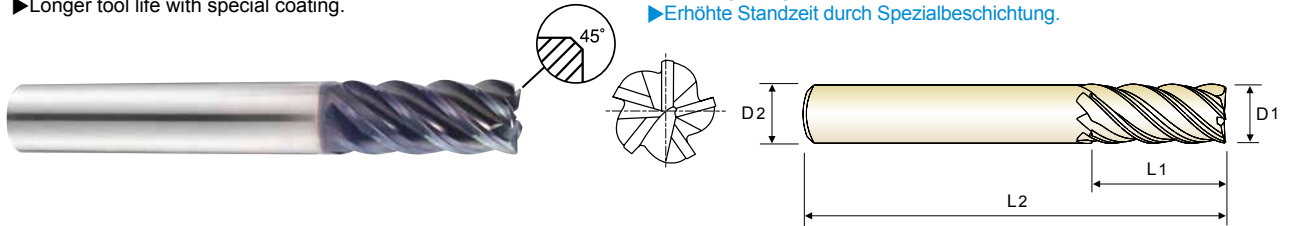

CARBIDE 5 43°/44°/45° PLAIN FLAT C x 45° P.409

Unit : mm

EDP No.		Mill Diameter	Shank Diameter	Length of Cut	Overall Length	Chamfer
PLAIN	FLAT	D1	D2	L1	L2	
GMG26060	GMG27060	6.0	6	13	57	0.20
GMG26080	GMG27080	8.0	8	19	63	0.20
GMG26100	GMG27100	10.0	10	22	72	0.30
GMG26120	GMG27120	12.0	12	26	83	0.35
GMG26160	GMG27160	16.0	16	36	92	0.40
GMG26200	GMG27200	20.0	20	44	104	0.50
GMG26250	GMG27250	25.0	25	54	121	0.50

Mill Dia. Tolerance (mm)	Shank Dia. Tolerance
0 ~ - 0.03	h5 * Shank Dia. ≥ Ø12 : h6

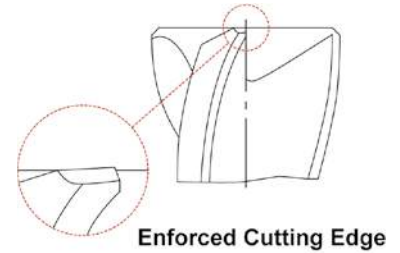

◎ : Excellent ○ : Good

ISO Material Description	P										M					K						
	Non-alloy steel					Low alloy steel					High alloyed steel, and tool steel					Stainless steel			Grey cast iron		Nodular cast iron	
VDI 3323	1	2	3	4	5	6	7	8	9	10	11	12	13	14	15	16	17	18	19	20		
HRc		13	25	28	32	10	29	32	38	15	35	15	23	10	10	26	3	25		21		
HB	125	190	250	270	300	180	275	300	350	200	325	200	240	180	180	260	160	250	130	230		
Recommend	○	○	○	○	○	○	○	○	○	○	○	◎	◎	◎	◎	◎	○	○	○	○		
ISO Material Description	N										S							H				
	Aluminum-wrought alloy		Aluminum-cast, alloyed			Copper and Copper Alloys (Bronze / Brass)			Non Metallic Materials		Heat Resistant Super Alloys					Titanium Alloys		Hardened steel	Chilled Cast Iron	Hardened Cast Iron		
VDI 3323	21	22	23	24	25	26	27	28	29	30	31	32	33	34	35	36	37	38	39	40	41	
HRc											15	30	25	38	34			55	60	42	55	
HB	60	100	75	90	130	110	90	100			200	280	250	350	320	400 Rm	1050 Rm	550	630	400	550	
Recommend											○	○	○	○	○	◎	◎					

CARBIDE, 5 FLUTE 40° HELIX CORNER RADIUS ROUGHING - FINE

- VOLLHARTMETALL, 5 SCHNEIDEN 40° HELIX mit ECKRADIUS FÜR FEINSCHRUPPEN
- CARBURE, 5 DENTS, HÉLICE 40°, TORIQUE, ÉBAUCHE PAS FINS
- FRESA IN MD, 5 TAGLIENTI, ELICA 40°, TORICA, BOMBATO FINE

- ▶ Excellent performance results and long tool life when machining Titanium and other tough materials.
- ▶ This tool has high rigidity of flute so that is possible to use for heavy profile and high speed milling.
- ▶ For protecting Corner chipping of end teeth, Corner Radius & Chamfer are adopted.
- ▶ Exzellente Leistungsergebnisse und hohe Standzeiten beim Bearbeiten von Titan oder anderen robusten Materialien.
- ▶ Die Schneiden des Werkzeugs haben eine besondere Festigkeit, so dass es für schwere Profile und zum High-Speed-Fräsen geeignet ist.
- ▶ Durch die Fase und den Eckradius werden Ausbrüche verhindert.

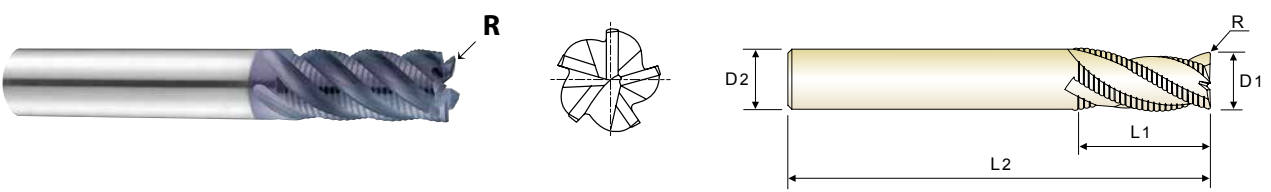

CARBIDE 5 40° HR PLAIN FLAT P.409

Unit : mm

EDP No.		Corner Radius	Mill Diameter	Shank Diameter	Length of Cut	Overall Length
PLAIN	FLAT	R	D1 (h10)	D2 (h6)	L1	L2
EHE54060	EHE55060	R0.2	6.0	6	16	57
EHE54080	EHE55080	R0.2	8.0	8	16	63
EHE54100	EHE55100	R0.3	10.0	10	22	72
EHE54120	EHE55120	R0.3	12.0	12	26	83
EHE54140	EHE55140	R0.3	14.0	14	26	83
EHE54160	EHE55160	R0.3	16.0	16	32	92
EHE54200	EHE55200	R0.3	20.0	20	38	104
EHE54250	EHE55250	R0.3	25.0	25	45	121

Tolerances according to DIN 7160 & 7161

Tolerance range in μm					
Nominal-Diameter in mm					
	from 1 to 3	over 3 to 6	over 6 to 10	over 10 to 18	over 18 to 30
h10	0 - 40	0 - 48	0 - 58	0 - 70	0 - 84
h5	0 - 4	0 - 5	0 - 6	0 - 8	0 - 9

* Shank Dia. $\geq \phi 12$: h6

◎ : Excellent ○ : Good

ISO Material Description	P										M				K						
	Non-alloy steel					Low alloy steel					High alloyed steel, and tool steel				Stainless steel		Grey cast iron		Nodular cast iron		Malleable cast iron
VDI 3323	1	2	3	4	5	6	7	8	9	10	11	12	13	14	15	16	17	18	19	20	
HRC	13	25	28	32	10	29	32	38	15	35	15	23	10	10	26	3	25	42	21		
HB	125	190	250	270	300	180	275	300	350	200	325	200	240	180	180	260	160	250	130	230	
Recommend												○	○	○							
ISO Material Description	N					S					H										
	Aluminum-wrought alloy		Aluminum-cast, alloyed			Copper and Copper Alloys (Bronze / Brass)		Non Metallic Materials			Heat Resistant Super Alloys					Titanium Alloys		Hardened steel	Chilled Cast Iron	Hardened Cast Iron	
VDI 3323	21	22	23	24	25	26	27	28	29	30	31	32	33	34	35	36	37	38	39	40	41
HRC	60	100	75	90	130	110	90	100			200	280	250	350	320	400 Rm	1050 Rm	550	630	400	550
Recommend											○	○	○	○	○	◎	◎				

GMG40, GMG41 SERIES 4 FLUTES CORNER RADIUS - SIDE CUTTING

Vc = m/min.
fz = mm/tooth
RPM = rev./min.
FEED = mm/min.

ISO	VDI 3323	Material Description	Ae	Ap	Parameter	Diameter (Ø)																																			
						6.0	8.0	10.0	12.0	14.0	16.0	20.0	25.0																												
P	1-4	Non-alloy steel	0.4D	1.0D	Vc	160	160	160	160	160	160	160	160	fz	0.027	0.035	0.042	0.053	0.058	0.063	0.077	0.084	RPM	8488	6366	5093	4244	3638	3183	2546	2037	FEED	917	891	856	900	844	802	784	684	
					Vc	150	150	150	150	150	150	150	150	150	fz	0.025	0.035	0.042	0.049	0.056	0.063	0.070	0.084	RPM	7958	5968	4775	3979	3410	2984	2387	1910	FEED	796	836	802	780	764	752	668	642
	5	Low alloy steel	0.4D	1.0D	Vc	160	160	160	160	160	160	160	160	fz	0.027	0.035	0.042	0.053	0.058	0.063	0.077	0.084	RPM	8488	6366	5093	4244	3638	3183	2546	2037	FEED	917	891	856	900	844	802	784	684	
					Vc	150	150	150	150	150	150	150	150	150	fz	0.025	0.035	0.042	0.049	0.056	0.063	0.070	0.084	RPM	7958	5968	4775	3979	3410	2984	2387	1910	FEED	796	836	802	780	764	752	668	642
	6-7	Low alloy steel	0.4D	1.0D	Vc	160	160	160	160	160	160	160	160	fz	0.027	0.035	0.042	0.053	0.058	0.063	0.077	0.084	RPM	8488	6366	5093	4244	3638	3183	2546	2037	FEED	917	891	856	900	844	802	784	684	
					Vc	150	150	150	150	150	150	150	150	150	fz	0.025	0.035	0.042	0.049	0.056	0.063	0.070	0.084	RPM	7958	5968	4775	3979	3410	2984	2387	1910	FEED	796	836	802	780	764	752	668	642
	8	Low alloy steel	0.4D	1.0D	Vc	150	150	150	150	150	150	150	150	fz	0.025	0.035	0.042	0.049	0.056	0.063	0.070	0.084	RPM	7958	5968	4775	3979	3410	2984	2387	1910	FEED	796	836	802	780	764	752	668	642	
					Vc	150	150	150	150	150	150	150	150	150	fz	0.027	0.035	0.046	0.053	0.060	0.067	0.077	0.084	RPM	7958	5968	4775	3979	3410	2984	2387	1910	FEED	859	836	879	844	819	800	735	642
	10-11.1	High alloyed steel, and tool steel	0.4D	1.0D	Vc	150	150	150	150	150	150	150	150	fz	0.027	0.035	0.046	0.053	0.060	0.067	0.077	0.084	RPM	7958	5968	4775	3979	3410	2984	2387	1910	FEED	859	836	879	844	819	800	735	642	
					Vc	155	155	155	155	155	155	155	155	155	fz	0.034	0.046	0.057	0.067	0.076	0.086	0.095	0.114	RPM	8223	6167	4934	4112	3524	3084	2467	1974	FEED	1118	1135	1125	1102	1071	1061	937	900
M	14.1	Stainless steel	0.4D	1.0D	Vc	105	105	105	105	105	105	105	105	fz	0.025	0.034	0.042	0.048	0.055	0.062	0.071	0.081	RPM	5570	4178	3342	2785	2387	2089	1671	1337	FEED	557	568	561	535	525	518	475	433	
					Vc	44	44	44	44	44	44	44	44	44	fz	0.016	0.021	0.027	0.032	0.036	0.040	0.046	0.052	RPM	2334	1751	1401	1167	1000	875	700	560	FEED	149	147	151	149	144	140	129	117
					Vc	175	175	175	175	175	175	175	175	175	fz	0.021	0.028	0.035	0.042	0.048	0.053	0.060	0.070	RPM	9284	6963	5570	4642	3979	3482	2785	2228	FEED	780	780	780	780	764	738	668	624
K	15-20	Grey cast iron	0.4D	1.0D	Vc	32	32	32	32	32	32	32	32	fz	0.020	0.026	0.032	0.038	0.044	0.048	0.055	0.065	RPM	1698	1273	1019	849	728	637	509	407	FEED	136	132	130	129	128	122	112	106	
					Vc	70	70	70	70	70	70	70	70	70	fz	0.034	0.048	0.057	0.067	0.076	0.086	0.095	0.114	RPM	3714	2785	2228	1857	1592	1393	1114	891	FEED	505	535	508	498	484	479	423	406
S	31-35	Heat Resistant Super Alloys	0.3D	0.6D	Vc	32	32	32	32	32	32	32	32	fz	0.020	0.026	0.032	0.038	0.044	0.048	0.055	0.065	RPM	1698	1273	1019	849	728	637	509	407	FEED	136	132	130	129	128	122	112	106	
					Vc	70	70	70	70	70	70	70	70	70	fz	0.034	0.048	0.057	0.067	0.076	0.086	0.095	0.114	RPM	3714	2785	2228	1857	1592	1393	1114	891	FEED	505	535	508	498	484	479	423	406
36-37	Titanium Alloys	0.4D	1.0D	Vc	70	70	70	70	70	70	70	70	fz	0.034	0.048	0.057	0.067	0.076	0.086	0.095	0.114	RPM	3714	2785	2228	1857	1592	1393	1114	891	FEED	505	535	508	498	484	479	423	406		

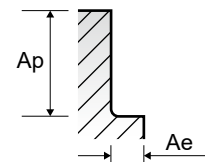

GMG40, GMG41 SERIES

4 FLUTES CORNER RADIUS - SLOTTING

Vc = m/min.
fz = mm/tooth
RPM = rev./min.
FEED = mm/min.

ISO	VDI 3323	Material Description	Ae	Ap	Parameter	Diameter (Ø)							
						6.0	8.0	10.0	12.0	14.0	16.0	20.0	25.0
P	1-4	Non-alloy steel	1.0D	1.0D	Vc	125	125	125	125	125	125	125	125
					fz	0.025	0.034	0.042	0.049	0.056	0.063	0.070	0.084
					RPM	6631	4974	3979	3316	2842	2487	1989	1592
					FEED	663	676	668	650	637	627	557	535
	5	Low alloy steel	1.0D	1.0D	Vc	120	120	120	120	120	120	120	120
					fz	0.025	0.034	0.042	0.049	0.056	0.063	0.070	0.077
					RPM	6366	4775	3820	3183	2728	2387	1910	1528
					FEED	637	649	642	624	611	602	535	471
	6-7	Low alloy steel	1.0D	1.0D	Vc	125	125	125	125	125	125	125	125
					fz	0.025	0.034	0.042	0.049	0.056	0.063	0.070	0.084
					RPM	6631	4974	3979	3316	2842	2487	1989	1592
					FEED	663	676	668	650	637	627	557	535
	8-9	Low alloy steel	1.0D	1.0D	Vc	120	120	120	120	120	120	120	120
					fz	0.025	0.034	0.042	0.049	0.056	0.063	0.070	0.077
					RPM	6366	4775	3820	3183	2728	2387	1910	1528
					FEED	637	649	642	624	611	602	535	471
	10-11.1	High alloyed steel, and tool steel	1.0D	1.0D	Vc	120	120	120	120	120	120	120	120
					fz	0.027	0.035	0.042	0.053	0.058	0.063	0.077	0.084
					RPM	6366	4775	3820	3183	2728	2387	1910	1528
					FEED	688	668	642	675	633	602	588	513
M	12-13	Stainless steel	1.0D	1.0D	Vc	125	125	125	125	125	125	125	
					fz	0.034	0.046	0.057	0.067	0.074	0.081	0.095	0.105
	14.1	Stainless steel	1.0D	1.0D	RPM	6631	4974	3979	3316	2842	2487	1989	1592
					FEED	902	915	907	889	841	806	756	668
					Vc	85	85	85	85	85	85	85	85
	14.2	Stainless steel	1.0D	0.5D	fz	0.025	0.034	0.042	0.048	0.055	0.062	0.071	0.081
RPM					4509	3382	2706	2255	1933	1691	1353	1082	
FEED	451	460	455	433	425	419	384	351					
K	15-20	Grey cast iron	1.0D	1.0D	Vc	140	140	140	140	140	140	140	140
					fz	0.021	0.028	0.035	0.042	0.048	0.053	0.060	0.067
					RPM	7427	5570	4456	3714	3183	2785	2228	1783
					FEED	624	624	624	624	611	590	535	478
S	31-35	Heat Resistant Super Alloys	1.0D	0.4D	Vc	25	25	25	25	25	25	25	25
					fz	0.018	0.024	0.030	0.036	0.040	0.044	0.050	0.055
					RPM	1326	995	796	663	568	497	398	318
	36-37	Titanium Alloys	1.0D	1.0D	FEED	95	95	95	95	91	88	80	70
					Vc	55	55	55	55	55	55	55	55
					fz	0.034	0.046	0.057	0.067	0.076	0.086	0.095	0.105
RPM	2918	2188	1751	1459	1251	1094	875	700					
FEED	397	403	399	391	380	376	333	294					

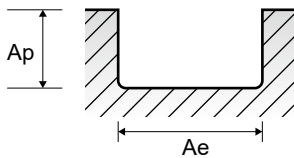

GMG28 GMG29 GMG30 GMG31 5 FLUTE CORNER RADIUS - **SIDE CUTTING**

Vc = m/min.
fz = mm/tooth
RPM = rev./min.
FEED = mm/min.

ISO	VDI 3323	Material Description	Ae	Ap	Parameter	Diameter (Ø)									
						6.0	8.0	10.0	12.0	14.0	16.0	18.0	20.0	25.0	
P	1-4	Non-alloy steel	0.3D	1.5D(*)	Vc	144	144	144	144	144	144	144	144	144	144
					fz	0.034	0.038	0.050	0.063	0.069	0.076	0.083	0.089	0.101	
					RPM	7639	5730	4584	3820	3274	2865	2546	2292	1833	
	5	Low alloy steel	0.3D	1.5D(*)	Vc	101	101	101	101	101	101	101	101	101	101
					fz	0.034	0.038	0.050	0.063	0.069	0.076	0.083	0.089	0.101	
					RPM	5358	4019	3215	2679	2296	2009	1786	1607	1286	
	6-7	High alloyed steel, and tool steel	0.3D	1.5D(*)	Vc	144	144	144	144	144	144	144	144	144	144
					fz	0.034	0.038	0.050	0.063	0.069	0.076	0.083	0.089	0.101	
					RPM	7639	5730	4584	3820	3274	2865	2546	2292	1833	
	8-9	Stainless steel	0.3D	1.5D(*)	Vc	101	101	101	101	101	101	101	101	101	101
					fz	0.034	0.038	0.050	0.063	0.069	0.076	0.083	0.089	0.101	
					RPM	5358	4019	3215	2679	2296	2009	1786	1607	1286	
	10-11.1	Grey cast iron	0.3D	1.5D(*)	Vc	60	60	60	60	60	60	60	60	60	60
					fz	0.024	0.027	0.035	0.044	0.049	0.054	0.058	0.062	0.071	
					RPM	3183	2387	1910	1592	1364	1194	1061	955	764	
	M	12-13	Heat Resistant Super Alloys	0.3D	1.5D(*)	Vc	117	117	117	117	117	117	117	117	117
fz						0.024	0.025	0.030	0.046	0.051	0.054	0.057	0.061	0.071	
RPM						6207	4655	3724	3104	2660	2328	2069	1862	1490	
14.1		Titanium Alloys	0.3D	1.5D(*)	Vc	82	82	82	82	82	82	82	82	82	
					fz	0.030	0.032	0.038	0.063	0.065	0.069	0.070	0.076	0.088	
					RPM	4350	3263	2610	2175	1864	1631	1450	1305	1044	
14.2		Aluminum	0.3D	1.5D(*)	Vc	59	59	59	59	59	59	59	59	59	
					fz	0.030	0.032	0.038	0.063	0.065	0.069	0.070	0.076	0.088	
					RPM	3130	2348	1878	1565	1341	1174	1043	939	751	
15-20		Copper	0.3D	1.5D(*)	Vc	106	106	106	106	106	106	106	106	106	
					fz	0.043	0.048	0.063	0.079	0.087	0.096	0.103	0.111	0.126	
					RPM	5623	4218	3374	2812	2410	2109	1874	1687	1350	
S	31-35	Inconel	0.1D	1.5D	Vc	31	31	31	31	31	31	31	31	31	
					fz	0.021	0.022	0.027	0.044	0.046	0.048	0.049	0.053	0.062	
					RPM	1645	1233	987	822	705	617	548	493	395	
	36-37	Aluminum	0.3D	1.5D(*)	Vc	69	69	69	69	69	69	69	69	69	
					fz	0.027	0.029	0.034	0.057	0.059	0.062	0.063	0.069	0.079	
					RPM	3661	2745	2196	1830	1569	1373	1220	1098	879	

- * Maximum recommended depth shown.
- * Finish cuts typically require reduced feed rates and/or higher spindle speed, with radial width of 2% x D1 or less.
- * Reduce speed and feed recommendations for materials harder than listed.
- * Above recommendations are based on ideal conditions.
- Adjust parameters accordingly for smaller taper machining centers or less rigid conditions.

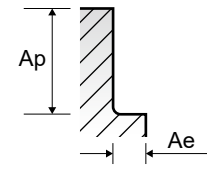

GMG24 GMG25 **GMG26 GMG27** **5 FLUTE - SIDE CUTTING**

Vc = m/min.
fz = mm/tooth
RPM = rev./min.
FEED = mm/min.

ISO	VDI 3323	Material Description	Ae	Ap	Parameter	Diameter (Ø)																																											
						6.0	8.0	10.0	12.0	14.0	16.0	18.0	20.0	25.0																																			
P	1-4	Non-alloy steel	0.3D	1.5D(*)	Vc	144	144	144	144	144	144	144	144	144	144	fz	0.034	0.038	0.050	0.063	0.069	0.076	0.083	0.089	0.101	RPM	7639	5730	4584	3274	2865	2546	2292	2009	1786	1607	1286	FEED	1299	1089	1146	1203	1130	1089	1057	1020	926		
					Vc	101	101	101	101	101	101	101	101	101	101	101	101	fz	0.034	0.038	0.050	0.063	0.069	0.076	0.083	0.089	0.101	RPM	5358	4019	3215	2679	2296	2009	1786	1607	1286	FEED	911	764	804	844	792	764	741	715	649		
					Vc	144	144	144	144	144	144	144	144	144	144	144	144	fz	0.034	0.038	0.050	0.063	0.069	0.076	0.083	0.089	0.101	RPM	7639	5730	4584	3820	3274	2865	2546	2292	1833	FEED	1299	1089	1146	1203	1130	1089	1057	1020	926		
					Vc	101	101	101	101	101	101	101	101	101	101	101	101	fz	0.034	0.038	0.050	0.063	0.069	0.076	0.083	0.089	0.101	RPM	5358	4019	3215	2679	2296	2009	1786	1607	1286	FEED	911	764	804	844	792	764	741	715	649		
	5	Low alloy steel	0.3D	1.5D(*)	Vc	101	101	101	101	101	101	101	101	101	101	fz	0.034	0.038	0.050	0.063	0.069	0.076	0.083	0.089	0.101	RPM	5358	4019	3215	2679	2296	2009	1786	1607	1286	FEED	911	764	804	844	792	764	741	715	649				
					Vc	144	144	144	144	144	144	144	144	144	144	144	fz	0.034	0.038	0.050	0.063	0.069	0.076	0.083	0.089	0.101	RPM	7639	5730	4584	3820	3274	2865	2546	2292	1833	FEED	1299	1089	1146	1203	1130	1089	1057	1020	926			
					Vc	101	101	101	101	101	101	101	101	101	101	101	101	fz	0.034	0.038	0.050	0.063	0.069	0.076	0.083	0.089	0.101	RPM	5358	4019	3215	2679	2296	2009	1786	1607	1286	FEED	911	764	804	844	792	764	741	715	649		
					Vc	60	60	60	60	60	60	60	60	60	60	60	60	fz	0.024	0.027	0.035	0.044	0.049	0.054	0.058	0.062	0.071	RPM	3183	2387	1910	1592	1364	1194	1061	955	764	FEED	382	322	334	350	334	322	308	296	271		
	10-11.1	High alloyed steel, and tool steel	0.3D	1.5D(*)	Vc	117	117	117	117	117	117	117	117	117	117	fz	0.024	0.025	0.030	0.046	0.051	0.054	0.057	0.061	0.071	RPM	6207	4655	3724	3104	2660	2328	2069	1862	1490	FEED	745	582	559	714	678	628	590	568	529				
					Vc	82	82	82	82	82	82	82	82	82	82	82	82	fz	0.030	0.032	0.038	0.063	0.065	0.069	0.070	0.076	0.088	RPM	4350	3263	2610	2175	1864	1631	1450	1305	1044	FEED	653	522	496	685	606	563	508	496	459		
					Vc	59	59	59	59	59	59	59	59	59	59	59	59	fz	0.030	0.032	0.038	0.063	0.065	0.069	0.070	0.076	0.088	RPM	3130	2348	1878	1565	1341	1174	1043	939	751	FEED	470	376	357	493	436	405	365	357	331		
					Vc	106	106	106	106	106	106	106	106	106	106	106	106	fz	0.043	0.048	0.063	0.079	0.087	0.096	0.103	0.111	0.126	RPM	5623	4218	3374	2812	2410	2109	1874	1687	1350	FEED	1209	1012	1063	1111	1048	1012	965	936	850		
					Vc	31	31	31	31	31	31	31	31	31	31	31	31	fz	0.021	0.022	0.027	0.044	0.046	0.048	0.049	0.053	0.062	RPM	1645	1233	987	822	705	617	548	493	395	FEED	173	136	133	181	162	148	134	131	122		
					36-37	Titanium Alloys	0.3D	1.5D(*)	Vc	69	69	69	69	69	69	69	69	69	69	fz	0.027	0.029	0.034	0.057	0.059	0.062	0.063	0.069	0.079	RPM	3661	2745	2196	1830	1569	1373	1220	1098	879	FEED	494	398	373	522	463	426	384	379	347

- * Maximum recommended depth shown.
 - * Finish cuts typically require reduced feed rates and/or higher spindle speed, with radial width of 2% x D1 or less.
 - * Reduce speed and feed recommendations for materials harder than listed.
 - * Above recommendations are based on ideal conditions.
- Adjust parameters accordingly for smaller taper machining centers or less rigid conditions.

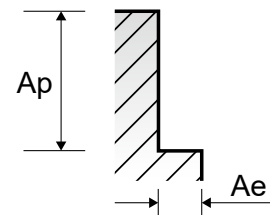

EHE54, EHE55 SERIES **5 FLUTES ROUGHING - SIDE CUTTING**

ISO	VDI 3323	Material Description	Ae	Ap	Parameter	Diameter (Ø)																																								
						6.0	8.0	10.0	12.0	14.0	16.0	20.0	25.0																																	
M	12-13	Stainless steel	~Ø10/0.15D ~Ø16/0.10D ~Ø25/0.05D	1.5D	Vc	80	80	80	80	80	80	80	80	80	fz	0.025	0.034	0.041	0.051	0.057	0.063	0.081	0.091	RPM	4244	3183	2546	2122	1819	1592	1273	1019	FEED	531	541	522	541	518	501	516	463					
					Vc	40	40	40	40	40	40	40	40	40	40	40	fz	0.020	0.025	0.037	0.040	0.046	0.052	0.061	0.068	RPM	2122	1592	1273	1061	909	796	637	509	FEED	212	199	236	212	209	207	194	173			
					Vc	65	65	65	65	65	65	65	65	65	65	65	65	fz	0.022	0.031	0.038	0.046	0.052	0.058	0.074	0.084	RPM	3448	2586	2069	1724	1478	1293	1035	828	FEED	379	401	393	397	384	375	383	348		



Global Cutting Tool Leader **YG-1**



MILLING



Leading Through Innovation



SOLID CARBIDE

JET-POWER END MILLS

JET - POWER VHM/HSS-PM - FRÄSERFRÄSER

- For Exotic materials like Stainless Steels, Nickel Alloys and Titanium
- Für Sonderwerkstoffe wie rostfreie Stähle, Nickellegierungen und Titan.

SELECTION GUIDE



SERIES	EH911 EH912	EH913 EH914	EH830 EH840
FLUTE	2	4	3&4
HELIX ANGLE	35°	35°	50°
CUTTING EDGE SHAPE	SQUARE	SQUARE	SQUARE
SIZE MIN	D1.0	D2.0	D6.0
SIZE MAX	D25.0	D25.0	D25.0
PAGE	414	416	418

SOLID CARBIDE
JET-POWER
END MILLS

Exotic materials like Stainless Steels
Nickel alloys and Titanium



Please visit
globalyg1.com/mat
for material search

◎ : Excellent ○ : Good

Recommended cutting conditions : P 426

ISO	VDI 3323	Material Description	Composition / Structure / Heat Treatment	HB	HRc	SHORT LENGTH TiAIN	SHORT LENGTH TiAIN	LONG LENGTH TiAIN
P	1	Non-alloy steel	About 0.15% C Annealed	125		○	○	○
	2		About 0.45% C Annealed	190	13	○	○	○
	3		About 0.45% C Quenched & Tempered	250	25	◎	◎	◎
	4		About 0.75% C Annealed	270	28	◎	◎	◎
	5		About 0.75% C Quenched & Tempered	300	32	◎	◎	◎
	6	Low alloy steel	Annealed	180	10	○	○	○
	7		Quenched & Tempered	275	29	◎	◎	◎
	8		Quenched & Tempered	300	32	◎	◎	◎
	9		Quenched & Tempered	350	38	◎	◎	◎
	10		High alloyed steel, and tool steel	Annealed	200	15	○	○
	11	Quenched & Tempered		325	35	◎	◎	◎
M	12	Stainless steel	Ferritic / Martensitic Annealed	200	15	○	○	○
	13		Martensitic Quenched & Tempered	240	23	○	○	○
	14		Austenitic	180	10	◎	◎	◎
K	15	Grey cast iron	Pearlitic / ferritic	180	10			
	16		Pearlitic (Martensitic)	260	26			
	17	Nodular cast iron	Ferritic	160	3			
	18		Pearlitic	250	25			
	19		Ferritic	130				
20	Malleable cast iron	Pearlitic	230	21				
N	21	Aluminum- wrought alloy	Not Curable	60				
	22		Curable Hardened	100				
	23	Aluminum-cast, alloyed	≤ 12% Si, Not Curable	75				
	24		≤ 12% Si, Curable Hardened	90				
	25		> 12% Si, Not Curable	130				
	26	Copper and Copper Alloys (Bronze / Brass)	Cutting Alloys, PB>1%	110				
	27		CuZn, CuSnZn (Brass)	90				
	28		CuSn, lead-free copper and electrolytic copper	100				
	29	Non Metallic Materials	Duroplastic, Fiber Reinforced Plastic					
	30		Rubber, Wood, etc.					
S	31	Heat Resistant Super Alloys	Fe Based Annealed	200	15			○
	32		Cured	280	30			○
	33		Annealed	250	25			○
	34		Ni or Co Based Cured	350	38			○
	35		Cast	320	34			○
	36	Titanium Alloys	Pure Titanium	400 Rm		◎	◎	◎
	37		Alpha + Beta Alloys Hardened	1050 Rm		◎	◎	◎
H	38	Hardened steel	Hardened	550	55			
	39		Hardened	630	60			
	40	Chilled Cast Iron	Cast	400	42	○	○	○
	41	Hardened Cast Iron	Hardened	550	55			

EH915 EH916	EE515	EH852 EH862	EH831 EH841	EH917 EH918	EH919 EH920	EH921 EH942
6&8	4&6	Multi Flute	Multi Flute	Multi Flute	Multi Flute	Multi Flute
45°	30°	30°	30°	45°	45°	45°
SQUARE	SQUARE	ROUGHING	ROUGHING	ROUGHING	ROUGHING	ROUGHING
D6.0	D3.0	D6.0	D6.0	D6.0	D4.0	D6.0
D25.0	D25.0	D25.0	D25.0	D20.0	D25.0	D20.0
419	420	421	422	423	424	425
LONG LENGTH	HSS-PM SHORT LENGTH	SHORT LENGTH	LONG LENGTH	SHORT LENGTH	LONG LENGTH	LONG LENGTH
TiAIN	TiAIN	TiAIN	TiAIN	TiAIN	TiAIN	TiAIN

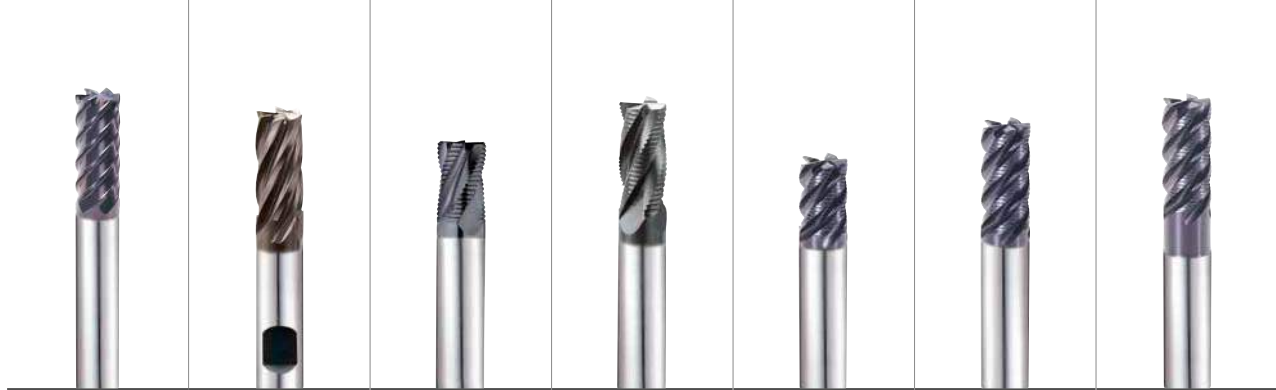

○	○	○	○	○	○	○	1
○	○	○	○	○	○	○	2
◎	◎	◎	◎	◎	◎	◎	3
◎	◎	◎	◎	◎	◎	◎	4
◎	◎	◎	◎	◎	◎	◎	5
○	○	○	○	○	○	○	6 P
◎	◎	◎	◎	◎	◎	◎	7
◎	◎	◎	◎	◎	◎	◎	8
◎	◎	◎	◎	◎	◎	◎	9
○	○	○	○	○	○	○	10
◎	◎	◎	◎	◎	◎	◎	11
○	○	○	○	○	○	○	12
○	○	○	○	○	○	○	13 M
◎	◎	◎	◎	◎	◎	◎	14
							15
							16
							17 K
							18
							19
							20
							21
							22
							23
							24
							25 N
							26
							27
							28
							29
							30
○	○	○	○	○	○	○	31
○	○	○	○	○	○	○	32
○	○	○	○	○	○	○	33
○	○	○	○	○	○	○	34 S
○	○	○	○	○	○	○	35
◎	◎	◎	◎	◎	◎	◎	36
◎	◎	◎	◎	◎	◎	◎	37
							38
○	○	○	○	○	○	○	39 H
							40
							41

HSS

CBN
END MILLS

i-Xmill
END MILLS

i-SMART
MODULAR
END MILLS

X5070
END MILLS

4G MILL
END MILLS

X-POWER
PRO
END MILLS

TitaNox-
POWER
END MILLS

JET-POWER
END MILLS

V7 PLUS
END MILLS

ALU-POWER
HPC
END MILLS

ALU-
POWER
END MILLS

D-POWER
GRAPHITE
END MILLS

D-POWER
CFRP
END MILLS

ROUTERS

CRX S
END MILLS

K-2
END MILLS

ONLY ONE
COATED PM60
END MILLS

TANK-
POWER
END MILLS

GENERAL
HSS
END MILLS

MILLING
CUTTERS

TECHNICAL
DATA

CARBIDE, 2 FLUTE 35° HELIX SHORT LENGTH

● **VOLLHARTMETALL, 2 SCHNEIDEN 35° RECHTSSPIRALE KURZ**
 ● **Fraise carbure, 2 dents, hélice 35°, courte**
 ● **2 TAGLIENTI, ELICA 35°, CORTA**

- ▶ Ultra micro grain carbide
- ▶ Reduces chipping of corner edges
- ▶ Suitable for low hardness materials (under HRc45), alloy steels, tool steels, carbon steels, prehardened steels, stainless steels, etc
- ▶ Ultra Feinstkorn - Vollhartmetall.
- ▶ Verstärkte Schneidkante.
- ▶ zur Bearbeitung von: Werkstoffen bis 45 HRc, rostfreien Stählen, Titan und Nickellegierungen.

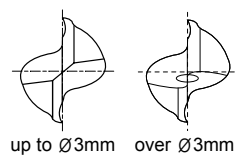

CARBIDE 2 35° PLAIN FLAT P.426

Unit : mm

EDP No.		Mill Diameter	Shank Diameter	Length of Cut	Overall Length
PLAIN	FLAT	D1	D2	L1	L2
EH911010	-	1.0	4	2.5	40
EH911901	EH912901	1.0	6	2.5	40
EH911015	-	1.5	4	4	40
EH911902	EH912902	1.5	6	4	40
EH911020	-	2.0	4	6	40
EH911903	EH912903	2.0	6	6	40
EH911025	-	2.5	4	8	40
EH911904	EH912904	2.5	6	8	40
EH911030	EH912030	3.0	6	8	45
EH911035	EH912035	3.5	6	10	45
EH911040	EH912040	4.0	6	11	45
EH911045	EH912045	4.5	6	11	45
EH911050	EH912050	5.0	6	13	50
EH911055	EH912055	5.5	6	13	50
EH911060	EH912060	6.0	6	13	50
EH911065	EH912065	6.5	8	16	60
EH911070	EH912070	7.0	8	16	60
EH911075	EH912075	7.5	8	16	60
EH911080	EH912080	8.0	8	19	60
EH911085	EH912085	8.5	10	19	70

Mill Dia. Tolerance (mm)	Shank Dia. Tolerance
0 ~ - 0.03	h5

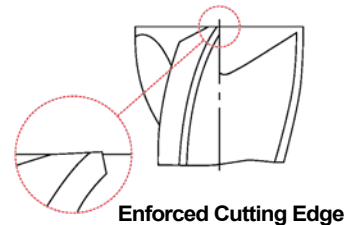

▶ NEXT PAGE

◎ : Excellent ○ : Good

ISO Material Description	P											M			K					
	Non-alloy steel					Low alloy steel				High alloyed steel, and tool steel		Stainless steel			Grey cast iron		Nodular cast iron		Malleable cast iron	
VDI 3323	1	2	3	4	5	6	7	8	9	10	11	12	13	14	15	16	17	18	19	20
HRc		13	25	28	32	10	29	32	38	15	35	15	23	10	10	26	3	25		21
HB	125	190	250	270	300	180	275	300	350	200	325	200	240	180	180	260	160	250	130	230
Recommend	○	○	◎	◎	◎	○	◎	◎	◎	○	◎	○	○	◎						

ISO Material Description	N										S					H					
	Aluminum-wrought alloy		Aluminum-cast, alloyed			Copper and Copper Alloys (Bronze / Brass)			Non Metallic Materials		Heat Resistant Super Alloys					Titanium Alloys		Hardened steel	Chilled Cast Iron	Hardened Cast Iron	
VDI 3323	21	22	23	24	25	26	27	28	29	30	31	32	33	34	35	36	37	38	39	40	41
HRc											15	30	25	38	34			55	60	42	55
HB	60	100	75	90	130	110	90	100			200	280	250	350	320	400 Rm	1050 Rm	550	630	400	550
Recommend																◎	◎			○	

CARBIDE, 2 FLUTE 35° HELIX SHORT LENGTH

- VOLLHARTMETALL, 2 SCHNEIDEN 35° RECHTSSPIRALE KURZ
- () Fraise carbure, 2 dents, hélice 35°, courte
- () 2 TAGLIENTI, ELICA 35°, CORTA

- ▶ Ultra micro grain carbide
- ▶ Reduces chipping of corner edges
- ▶ Suitable for low hardness materials(under HRC45), alloy steels, tool steels, carbon steels, prehardened steels, stainless steels, etc

- ▶ Ultra Feinstkorn - Vollhartmetall.
- ▶ Verstärkte Schneidkante.
- ▶ zur Bearbeitung von: Werkstoffen bis 45 HRc, rostfreien Stählen, Titan und Nickellegierungen.

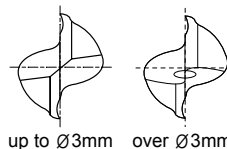

CARBIDE 2 35° PLAIN FLAT P.426

EDP No.		Mill Diameter	Shank Diameter	Length of Cut	Overall Length
PLAIN	FLAT	D1	D2	L1	L2
EH911090	EH912090	9.0	10	19	70
EH911095	EH912095	9.5	10	19	70
EH911100	EH912100	10.0	10	22	70
EH911110	EH912110	11.0	12	22	75
EH911120	EH912120	12.0	12	26	75
EH911140	EH912140	14.0	16	26	85
EH911160	EH912160	16.0	16	32	100
EH911180	EH912180	18.0	16	32	100
EH911200	EH912200	20.0	20	38	105
EH911220	EH912220	22.0	20	38	105
EH911250	EH912250	25.0	25	45	120

Mill Dia. Tolerance (mm)	Shank Dia. Tolerance
0 ~ - 0.03	h5

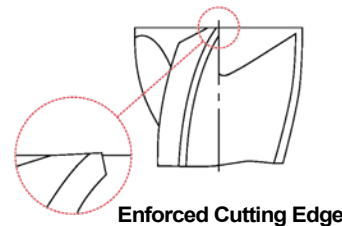

ISO Material Description	P										M				K						
	Non-alloy steel					Low alloy steel					High alloyed steel, and tool steel				Stainless steel		Grey cast iron		Nodular cast iron		Malleable cast iron
VDI 3323	1	2	3	4	5	6	7	8	9	10	11	12	13	14	15	16	17	18	19	20	
HRc																					
HB	125	190	250	270	300	180	275	300	350	200	325	200	240	180	180	260	160	250	130	230	
Recommend	○	○	◎	◎	◎	○	◎	◎	◎	○	◎	○	◎	◎	○	◎					

ISO Material Description	N					S										H					
	Aluminum-wrought alloy		Aluminum-cast, alloyed			Copper and Copper Alloys (Bronze / Brass)			Non Metallic Materials		Heat Resistant Super Alloys					Titanium Alloys		Hardened steel	Chilled Cast Iron	Hardened Cast Iron	
VDI 3323	21	22	23	24	25	26	27	28	29	30	31	32	33	34	35	36	37	38	39	40	41
HRc																					
HB	60	100	75	90	130	110	90	100			200	280	250	350	320	400 Rm	1050 Rm	550	630	400	550
Recommend																◎	◎			○	

CARBIDE, 4 FLUTE 35° HELIX SHORT LENGTH

- **VOLLHARTMETALL, 4 SCHNEIDEN 35° RECHTSSPIRALE KURZ**
- **Fraise carbure, 4 dents, hélice 35°, courte**
- **4 TAGLIENTI, ELICA 35°, CORTA**

- ▶ Ultra micro grain carbide
- ▶ Reduces chipping of corner edges
- ▶ Suitable for low hardness materials(under HRc45), alloy steels, tool steels, carbon steels, prehardened steels, stainless steels, etc

- ▶ Ultra Feinstkorn - Vollhartmetall
- ▶ Verstärkte Schneidkante.
- ▶ Für die Bearbeitung von: Werkstoffen bis 45 HRc, rostfreien Stählen, Titan und Nickellegierungen.

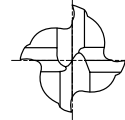

Unit : mm

EDP No.		Mill Diameter	Shank Diameter	Length of Cut	Overall Length
PLAIN	FLAT	D1	D2	L1	L2
EH913020	-	2.0	4	6	40
EH913901	EH914901	2.0	6	6	40
EH913025	-	2.5	4	8	40
EH913902	EH914902	2.5	6	8	40
EH913030	EH914030	3.0	6	8	45
EH913035	EH914035	3.5	6	10	45
EH913040	EH914040	4.0	6	11	45
EH913045	EH914045	4.5	6	11	45
EH913050	EH914050	5.0	6	13	50
EH913055	EH914055	5.5	6	13	50
EH913060	EH914060	6.0	6	13	50
EH913065	EH914065	6.5	8	16	60
EH913070	EH914070	7.0	8	16	60
EH913075	EH914075	7.5	8	16	60
EH913080	EH914080	8.0	8	19	60
EH913085	EH914085	8.5	10	19	70
EH913090	EH914090	9.0	10	19	70
EH913095	EH914095	9.5	10	19	70
EH913100	EH914100	10.0	10	22	70
EH913110	EH914110	11.0	12	22	75

▶ NEXT PAGE

Mill Dia. Tolerance (mm)	Shank Dia. Tolerance
0 ~ - 0.03	h5

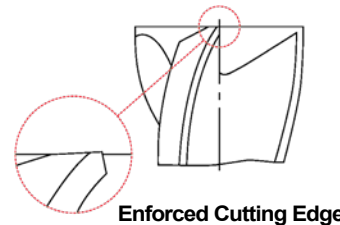

Enforced Cutting Edge

◎ : Excellent ○ : Good

ISO Material Description	P											M				K					
	Non-alloy steel					Low alloy steel				High alloyed steel, and tool steel		Stainless steel		Grey cast iron		Nodular cast iron		Malleable cast iron			
VDI 3323	1	2	3	4	5	6	7	8	9	10	11	12	13	14	15	16	17	18	19	20	
HRc		13	25	28	32	10	29	32	38	15	35	15	23	10	10	26	3	25		21	
HB	125	190	250	270	300	180	275	300	350	200	325	200	240	180	180	260	160	250	130	230	
Recommend	○	○	◎	◎	◎	○	◎	◎	◎	○	◎	○	○	◎							
ISO Material Description	N										S						H				
	Aluminum-wrought alloy		Aluminum-cast, alloyed			Copper and Copper Alloys (Bronze / Brass)			Non Metallic Materials		Heat Resistant Super Alloys						Titanium Alloys		Hardened steel	Chilled Cast Iron	Hardened Cast Iron
VDI 3323	21	22	23	24	25	26	27	28	29	30	31	32	33	34	35	36	37	38	39	40	41
HRc											15	30	25	38	34			55	60	42	55
HB	60	100	75	90	130	110	90	100			200	280	250	350	320	400 Rm	1050 Rm	550	630	400	550
Recommend																◎	◎			○	

CARBIDE, 4 FLUTE 35° HELIX SHORT LENGTH

- VOLLHARTMETALL, 4 SCHNEIDEN 35° RECHTSSPIRALE KURZ
- Fraise carbure, 4 dents, hélice 35°, courte
- 4 TAGLIANTI, ELICA 35°, CORTA

- ▶ Ultra micro grain carbide
- ▶ Reduces chipping of corner edges
- ▶ Suitable for low hardness materials(under HRc45), alloy steels, tool steels, carbon steels, prehardened steels, stainless steels, etc

- ▶ Ultra Feinstkorn - Vollhartmetall
- ▶ Verstärkte Schneidkante.
- ▶ Für die Bearbeitung von: Werkstoffen bis 45 HRc, rostfreien Stählen, Titan und Nickellegierungen.



CARBIDE 4 35° PLAIN FLAT P.427

Unit : mm

EDP No.		Mill Diameter	Shank Diameter	Length of Cut	Overall Length
PLAIN	FLAT	D1	D2	L1	L2
EH913120	EH914120	12.0	12	26	75
EH913140	EH914140	14.0	16	26	85
EH913160	EH914160	16.0	16	32	100
EH913180	EH914180	18.0	16	32	100
EH913200	EH914200	20.0	20	38	105
EH913220	EH914220	22.0	20	38	105
EH913250	EH914250	25.0	25	45	120

Mill Dia. Tolerance (mm)	Shank Dia. Tolerance
0 ~ - 0.03	h5

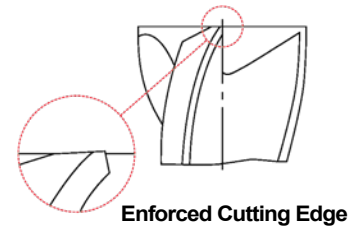

◎ : Excellent ○ : Good

ISO Material Description	P										M				K						
	Non-alloy steel					Low alloy steel					High alloyed steel, and tool steel				Stainless steel		Grey cast iron		Nodular cast iron		Malleable cast iron
VDI 3323	1	2	3	4	5	6	7	8	9	10	11	12	13	14	15	16	17	18	19	20	
HRc																					
HB	125	190	250	270	300	180	275	300	350	200	325	200	240	180	180	260	160	250	130	230	
Recommend	○	○	◎	◎	◎	○	◎	◎	◎	○	◎	○	○	◎	○	○	○	○	○	○	

ISO Material Description	N					S										H					
	Aluminum-wrought alloy		Aluminum-cast, alloyed			Copper and Copper Alloys (Bronze / Brass)			Non Metallic Materials		Heat Resistant Super Alloys					Titanium Alloys		Hardened steel	Chilled Cast Iron	Hardened Cast Iron	
VDI 3323	21	22	23	24	25	26	27	28	29	30	31	32	33	34	35	36	37	38	39	40	41
HRc																					
HB	60	100	75	90	130	110	90	100			200	280	250	350	320	400 Rm	1050 Rm	550	630	400	550
Recommend																◎	◎			○	

- CBN END MILLS
- i-Xmill END MILLS
- i-SMART MODULAR END MILLS
- X5070 END MILLS
- 4G MILL END MILLS
- X-POWER PRO END MILLS
- TitaNox-POWER END MILLS
- JET-POWER END MILLS
- V7 PLUS END MILLS
- ALU-POWER HPC END MILLS
- ALU-POWER END MILLS
- D-POWER GRAPHITE END MILLS
- D-POWER CFRP END MILLS
- ROUTERS
- CRX S END MILLS
- K-2 END MILLS
- ONLY ONE COATED PM60 END MILLS
- TANK-POWER END MILLS
- GENERAL HSS END MILLS
- MILLING CUTTERS
- TECHNICAL DATA

CARBIDE, 3&4 FLUTE 50° HELIX LONG LENGTH

- **VOLLHARTMETALL, 3&4 SCHNEIDEN 50° RECHTSSPIRALE LANG**
- **Fraise carbure, 3&4 dents, hélice 50°, longue**
- **3&4 TAGLIENTI, ELICA 50°, LUNGA**

- ▶ Ultra micro grain carbide
- ▶ Reduces chipping of corner edges
- ▶ Suitable for low hardness materials (under HRC45), alloy steels, tool steels, carbon steels, prehardened steels, stainless steels, etc

- ▶ Ultra Feinstkorn - Vollhartmetall
- ▶ Verstärkte Schneidkante.
- ▶ zur Bearbeitung von: Werkstoffen bis 45 HRC, rostfreien Stählen, Titan und Nickellegierungen.

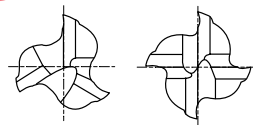

CARBIDE 3&4 50° PLAIN FLAT P.428-429

Unit : mm

EDP No.		Mill Diameter	Shank Diameter	Length of Cut	Overall Length	No. of Flute
PLAIN	FLAT	D1	D2	L1	L2	
▲ EH830060	▲ EH840060	6.0	6	13	50	3
▲ EH830080	▲ EH840080	8.0	8	19	60	3
▲ EH830100	▲ EH840100	10.0	10	22	70	3
▲ EH830120	▲ EH840120	12.0	12	25	75	3
▲ EH830160	▲ EH840160	16.0	16	32	90	3
▲ EH830180	▲ EH840180	18.0	18	32	90	3
▲ EH830200	▲ EH840200	20.0	20	38	100	4
▲ EH830250	▲ EH840250	25.0	25	45	120	4

▲ : Only available till stock runs out

Mill Dia. Tolerance (mm)	Shank Dia. Tolerance
0 ~ - 0.03	h5

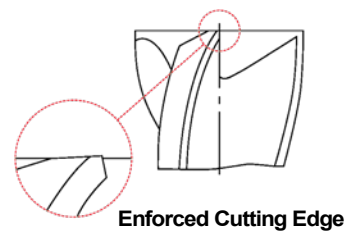

Enforced Cutting Edge

◎ : Excellent ○ : Good

ISO Material Description	P											M			K						
	Non-alloy steel					Low alloy steel				High alloyed steel, and tool steel		Stainless steel			Grey cast iron		Nodular cast iron	Malleable cast iron			
VDI 3323	1	2	3	4	5	6	7	8	9	10	11	12	13	14	15	16	17	18	19	20	
HRc		13	25	28	32	10	29	32	38	15	35	15	23	10	10	26	3	25		21	
HB	125	190	250	270	300	180	275	300	350	200	325	200	240	180	180	260	160	250	130	230	
Recommend	○	○	◎	◎	◎	◎	◎	◎	◎	○	◎	○	○	◎	◎	◎	◎	◎	◎	◎	
ISO Material Description	N									S							H				
	Aluminum-wrought alloy		Aluminum-cast, alloyed			Copper and Copper Alloys (Bronze / Brass)		Non Metallic Materials		Heat Resistant Super Alloys					Titanium Alloys		Hardened steel	Chilled Cast Iron	Hardened Cast Iron		
VDI 3323	21	22	23	24	25	26	27	28	29	30	31	32	33	34	35	36	37	38	39	40	41
HRc											15	30	25	38	34			55	60	42	55
HB	60	100	75	90	130	110	90	100			200	280	250	350	320	400 Rm	1050 Rm	550	630	400	550
Recommend											○	○	○	○	○	◎	◎			○	

CARBIDE, 6&8 FLUTE 45° HELIX LONG LENGTH (Positive Rake Angle)

- **VOLLHARTMETALL, 6&8 SCHNEIDEN 45° RECHTSSPIRALE LANG**
- () **Fraise carbure, 6&8 dents, hélice 45°, longue (Angle de coupe positif)**
- () **6&8 TAGLIANTI, ELICA 45°, LUNGA (Tagliante positivizzato)**

- ▶ Ultra micro grain carbide
- ▶ Reduces chipping of corner edges
- ▶ Suitable for low hardness materials(under HRc45), alloy steels, tool steels, carbon steels, prehardened steels, stainless steels, etc

- ▶ Ultra Feinstkorn - Vollhartmetall
- ▶ Verstärkte Schneidkante.
- ▶ zur Bearbeitung von: Werkstoffen bis 45 HRc, rostfreien Stählen, Titan und Nickellegierungen.

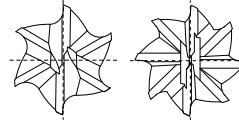

Unit : mm

EDP No.		Mill Diameter	Shank Diameter	Length of Cut	Overall Length	No. of Flute
PLAIN	FLAT	D1	D2	L1	L2	
EH915060	EH916060	6.0	6	13	57	6
EH915070	EH916070	7.0	8	16	63	6
EH915080	EH916080	8.0	8	19	63	6
EH915090	EH916090	9.0	10	19	72	6
EH915100	EH916100	10.0	10	22	72	6
EH915120	EH916120	12.0	12	26	83	6
EH915140	EH916140	14.0	14	26	83	6
EH915160	EH916160	16.0	16	32	92	6
EH915180	EH916180	18.0	18	32	92	8
EH915200	EH916200	20.0	20	38	104	8
EH915250	EH916250	25.0	25	44	104	8

Mill Dia. Tolerance (mm)	Shank Dia. Tolerance
0 ~ - 0.03	h5

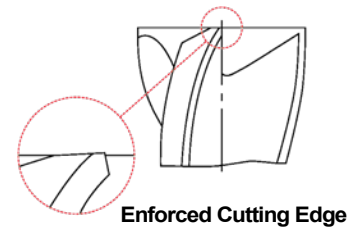

◎ : Excellent ○ : Good

ISO Material Description	P										M				K						
	Non-alloy steel					Low alloy steel					High alloyed steel, and tool steel				Stainless steel		Grey cast iron		Nodular cast iron		Malleable cast iron
VDI 3323	1	2	3	4	5	6	7	8	9	10	11	12	13	14	15	16	17	18	19	20	
HRc	13	25	28	32	10	29	32	38	10	35	15	23	10	10	26	3	25	130	21		
HB	125	190	250	270	300	180	275	300	350	200	325	200	240	180	180	260	160	250	130	230	
Recommend	○	○	◎	◎	◎	○	◎	◎	◎	○	◎	○	○	◎	○	◎	○	◎	○	◎	
ISO Material Description	N										S						H				
	Aluminum-wrought alloy		Aluminum-cast, alloyed			Copper and Copper Alloys (Bronze / Brass)			Non Metallic Materials		Heat Resistant Super Alloys						Titanium Alloys		Hardened steel	Chilled Cast Iron	Hardened Cast Iron
VDI 3323	21	22	23	24	25	26	27	28	29	30	31	32	33	34	35	36	37	38	39	40	41
HRc	60	100	75	90	130	110	90	100			15	30	25	38	34	55	60	55	60	42	55
HB	60	100	75	90	130	110	90	100			200	280	250	350	320	400 Rm	1050 Rm	550	630	400	550
Recommend											○	○	○	○	○	◎	◎	○	○	○	○

PREMIUM HSS-PM, 4&6 FLUTE SHORT LENGTH

- PREMIUM HSS-PM, 4&6 SCHNEIDEN KURZ
- Fraise HSS-PM Premium, 4&6 dents, courte
- 4&6 TAGLIENTI, CORTA (HSS-PM)

- ▶ Excellent performance on Low hardness materials (under HRc45), alloy steels, tool steels, carbon steels, prehardened steels, Stainless Steel, Titanium, Inconel.
- ▶ High chemical stability prevents built-up edge, micro cracks and crater wear.
- ▶ Superior workpiece finish.

- ▶ Ausgezeichnete Eignung zur Bearbeitung von weichen Materialien (bis HRc45), Legierten Stählen, kraterbildung, vorgehärtetem Stahl, rostfreiem Stahl, Titanium und Inconel.
- ▶ Hohe chemische Stabilität verhindert Kantenbildung, Mikrorisse und Krateraufzug.
- ▶ Höhere Oberflächengüte



HSS PM
4&6
30°
FLAT
P.431

Unit : mm

EDP No.	Mill Diameter	Shank Diameter	Length of Cut	Overall Length	No. of Flute
FLAT	D1	D2	L1	L2	
▲ EE515030	3.0	6	8	52	4
▲ EE515040	4.0	6	11	55	4
▲ EE515050	5.0	6	13	57	4
▲ EE515060	6.0	6	13	57	4
▲ EE515080	8.0	10	19	69	4
▲ EE515100	10.0	10	22	72	4
▲ EE515120	12.0	12	26	83	4
▲ EE515140	14.0	12	26	83	4
▲ EE515160	16.0	16	32	92	6
▲ EE515180	18.0	16	32	92	6
▲ EE515200	20.0	20	38	104	6
▲ EE515250	25.0	25	45	121	6

▲ : Only available till stock runs out

Mill Dia. Tolerance (mm)	Shank Dia. Tolerance
0 ~ +0.03	h6

◎ : Excellent ○ : Good

ISO Material Description	P											M				K							
	Non-alloy steel					Low alloy steel						High alloyed steel, and tool steel				Stainless steel				Grey cast iron		Nodular cast iron	
VDI 3323	1	2	3	4	5	6	7	8	9	10	11	12	13	14	15	16	17	18	19	20			
HRc		13	25	28	32	10	29	32	38	15	35	15	23	10	10	26	3	25	42	55			
HB	125	190	250	270	300	180	275	300	350	200	325	200	240	180	180	260	160	250	130	230			
Recommend	○	○	◎	◎	◎	◎	◎	◎	◎	○	◎	○	○	◎	○	○	○	○	○	○			
ISO Material Description	N										S							H					
	Aluminum-wrought alloy		Aluminum-cast, alloyed			Copper and Copper Alloys (Bronze / Brass)			Non Metallic Materials		Heat Resistant Super Alloys							Titanium Alloys		Hardened steel	Chilled Cast Iron	Hardened Cast Iron	
VDI 3323	21	22	23	24	25	26	27	28	29	30	31	32	33	34	35	36	37	38	39	40	41		
HRc											15	30	25	38	34	55	60	60	42	55			
HB	60	100	75	90	130	110	90	100			200	280	250	350	320	400 Rm	1050 Rm	550	630	400	550		
Recommend											○	○	○	○	○	◎	◎			○			

CARBIDE, MULTI FLUTE SHORT LENGTH ROUGHING - FINE

- VOLLHARTMETALL, MULTI SCHNEIDEN KURZ SCHRUPPFÄRER - FEIN
- Fraise carbure, multi-dents ébauche, pas fin, courte
- 3 - 4 - 5 TAGLIENTI, PER SGROSSATURA, CORTA - Bombato fine

- ▶ Suitable for low hardness materials (under HRC45), alloy steels, tool steels, carbon steels, prehardened steels, stainless steels, etc
- ▶ High velocity milling operation.
- ▶ Fast chip ejection.
- ▶ zur Bearbeitung von: Werkstoffen bis 45 HRc, rostfreien Stählen, Titan und Nickellegierungen..
- ▶ Hochgeschwindigkeitsfräsen.
- ▶ Schnelle Spanausfuhr



CARBIDE HR 3-5 30° PLAIN FLAT C x 45° P.432-433

Unit : mm

EDP No.		Mill Diameter	Shank Diameter	Length of Cut	Overall Length	No. of Flute	Chamfer
PLAIN	FLAT	h10	h5				
▲ EH852060	▲ EH862060	6.0	6	7	54	3	0.38
▲ EH852070	▲ EH862070	7.0	8	8	58	3	0.38
▲ EH852080	▲ EH862080	8.0	8	9	58	3	0.38
▲ EH852090	▲ EH862090	9.0	10	13	66	4	0.38
▲ EH852100	▲ EH862100	10.0	10	14	66	4	0.38
▲ EH852120	▲ EH862120	12.0	12	16	73	4	0.55
▲ EH852140	▲ EH862140	14.0	14	18	75	4	0.55
▲ EH852160	▲ EH862160	16.0	16	22	82	4	0.55
▲ EH852180	▲ EH862180	18.0	18	24	84	4	0.55
▲ EH852200	▲ EH862200	20.0	20	26	92	4	0.55
▲ EH852250	▲ EH862250	25.0	25	25	110	5	0.55

▲ : Only available till stock runs out

Tolerances according to DIN 7160 & 7161

Tolerance range in μm					
Nominal-Diameter in mm					
	from 1 to 3	over 3 to 6	over 6 to 10	over 10 to 18	over 18 to 30
h10	0 - 40	0 - 48	0 - 58	0 - 70	0 - 84
h5	0 - 4	0 - 5	0 - 6	0 - 8	0 - 9

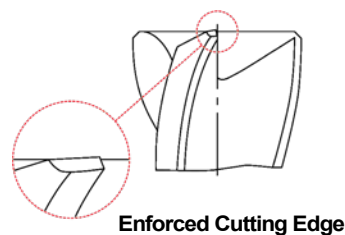

◎ : Excellent ○ : Good

ISO	P										M				K						
	Non-alloy steel					Low alloy steel					High alloyed steel, and tool steel				Stainless steel		Grey cast iron		Nodular cast iron		Malleable cast iron
Material Description	1	2	3	4	5	6	7	8	9	10	11	12	13	14	15	16	17	18	19	20	
VDI 3323	1	2	3	4	5	6	7	8	9	10	11	12	13	14	15	16	17	18	19	20	
HRc	125	13	25	28	32	10	29	32	38	15	35	15	23	10	10	26	3	25	42	21	
HB	125	190	250	270	300	180	275	300	350	200	325	200	240	180	180	260	160	250	130	230	
Recommend	○	○	◎	◎	◎	○	◎	◎	◎	◎	◎	○	○	◎	○	○	○	○	○	○	

ISO	N										S						H				
	Aluminum-wrought alloy		Aluminum-cast, alloyed			Copper and Copper Alloys (Bronze / Brass)			Non Metallic Materials		Heat Resistant Super Alloys						Titanium Alloys		Hardened steel	Chilled Cast Iron	Hardened Cast Iron
Material Description	21	22	23	24	25	26	27	28	29	30	31	32	33	34	35	36	37	38	39	40	41
VDI 3323	21	22	23	24	25	26	27	28	29	30	31	32	33	34	35	36	37	38	39	40	41
HRc	60	100	75	90	130	110	90	100			200	280	250	350	320	400 Rm	1050 Rm	550	630	400	550
HB	60	100	75	90	130	110	90	100			200	280	250	350	320	400 Rm	1050 Rm	550	630	400	550
Recommend	○	○	○	○	○	○	○	○	○	○	○	○	○	○	○	◎	◎	○	○	○	○

CARBIDE, MULTI FLUTE LONG LENGTH ROUGHING - FINE

- **VOLLHARTMETALL, MULTI SCHNEIDEN LANG SCHRUPPFRÄSER - FEIN**
- **Fraise carbure, multi-dents ébauche, pas fin, longue**
- **3 - 4 - 5 TAGLIANTI, PER SGROSSATURA, LUNGA - Bombato fine**

- ▶ Longer flute length than EH852, EH862.
- ▶ Suitable for low hardness materials (under HRc45), alloy steels, tool steels, carbon steels, prehardened steels, stainless steels, etc.
- ▶ High velocity milling operation.
- ▶ Fast chip ejection.

- ▶ Längere Schneiden als bei EH852 und EH862.
- ▶ zur Bearbeitung von: Werkstoffen bis 45 HRC, rostfreien Stählen, Titan und Nickellegierungen..
- ▶ Hochgeschwindigkeitsfräsen.
- ▶ Schnelle Spanausfuhr.

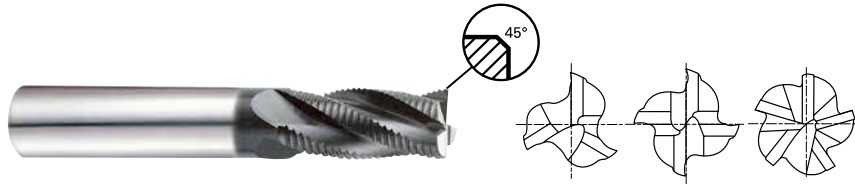

CARBIDE
HR
3-5
30°
PLAIN
FLAT
C x 45°
P.432-433

Unit : mm

EDP No.		Mill Diameter	Shank Diameter	Length of Cut	Overall Length	No. of Flute	Chamfer
PLAIN	FLAT	h10	h5				
EH831060	EH841060	6.0	6	16	57	3	0.38
EH831070	EH841070	7.0	8	16	63	3	0.38
EH831080	EH841080	8.0	8	16	63	3	0.38
EH831090	EH841090	9.0	10	19	72	4	0.38
EH831100	EH841100	10.0	10	22	72	4	0.38
EH831120	EH841120	12.0	12	26	83	4	0.55
EH831140	EH841140	14.0	14	26	83	4	0.55
EH831160	EH841160	16.0	16	32	92	4	0.55
EH831180	EH841180	18.0	18	32	92	4	0.55
EH831200	EH841200	20.0	20	38	104	4	0.55
EH831250	EH841250	25.0	25	45	121	5	0.55

Tolerances according to DIN 7160 & 7161

Tolerance range in μm					
Nominal-Diameter in mm					
	from 1 to 3	over 3 to 6	over 6 to 10	over 10 to 18	over 18 to 30
h10	0 - 40	0 - 48	0 - 58	0 - 70	0 - 84
h5	0 - 4	0 - 5	0 - 6	0 - 8	0 - 9

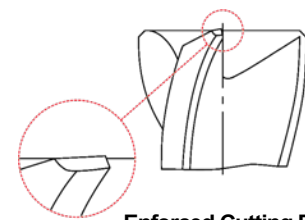

Enforced Cutting Edge

◎ : Excellent ○ : Good

ISO Material Description	P											M			K						
	Non-alloy steel					Low alloy steel				High alloyed steel, and tool steel		Stainless steel			Grey cast iron		Nodular cast iron		Malleable cast iron		
VDI 3323	1	2	3	4	5	6	7	8	9	10	11	12	13	14	15	16	17	18	19	20	
HRc		13	25	28	32	10	29	32	38	15	35	15	23	10	10	26	3	25		21	
HB	125	190	250	270	300	180	275	300	350	200	325	200	240	180	180	260	160	250	130	230	
Recommend	○	○	◎	◎	◎	○	◎	◎	◎	○	◎	○	○	◎							
ISO Material Description	N										S							H			
	Aluminum-wrought alloy		Aluminum-cast, alloyed			Copper and Copper Alloys (Bronze / Brass)		Non Metallic Materials			Heat Resistant Super Alloys					Titanium Alloys		Hardened steel	Chilled Cast Iron	Hardened Cast Iron	
VDI 3323	21	22	23	24	25	26	27	28	29	30	31	32	33	34	35	36	37	38	39	40	41
HRc											15	30	25	38	34			55	60	42	55
HB	60	100	75	90	130	110	90	100			200	280	250	350	320	400 Rm	1050 Rm	550	630	400	550
Recommend											○	○	○	○	○	◎	◎				

CARBIDE, MULTI FLUTE 45° HELIX SHORT LENGTH ROUGHING - FINE

- **VOLLHARTMETALL, MULTI SCHNEIDEN 45° RECHTSSPIRALE KURZ SCHRUPPFÄRER - FEIN**
- **Fraise carbure, multi-dents ébauche, hélice 45°, pas fin, courte**
- **4 - 5 - 6 TAGLIANTI, ELICA 45°, PER SGROSSATURA, CORTA - Bombato fine**

- ▶ Ultra micro grain carbide
- ▶ High chip removal and minimizing breakages of cutting edges.
- ▶ Suitable for low hardness materials(under HRc45), alloy steels, tool steels, carbon steels, prehardened steels, stainless steels, etc

- ▶ Ultra Feinstkorn - Vollhartmetall
- ▶ Schnelle Spanausfuhr und Minimierung von Abbrechen von Schneidkanten.
- ▶ zur Bearbeitung von: Werkstoffen bis 45 HRc, rostfreien Stählen, Titan und Nickellegierungen.

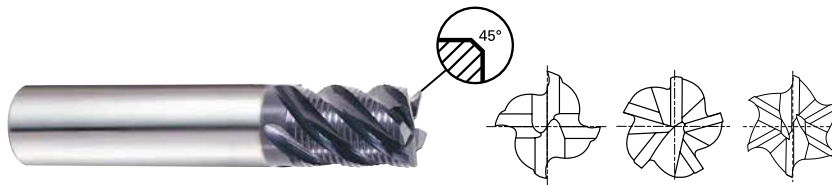

CARBIDE HR 4-6 45° PLAIN FLAT C x 45° P.434-435

Unit : mm

EDP No.		Mill Diameter	Shank Diameter	Length of Cut	Overall Length	No. of Flute	Chamfer
PLAIN	FLAT	h10	h5				
EH917060	EH918060	6.0	6	7	54	4	0.15
EH917080	EH918080	8.0	8	9	58	4	0.18
EH917100	EH918100	10.0	10	14	66	4	0.20
EH917120	EH918120	12.0	12	16	73	4	0.20
EH917160	EH918160	16.0	16	22	82	5	0.20
EH917200	EH918200	20.0	20	26	92	6	0.20

Tolerances according to DIN 7160 & 7161

	Tolerance range in μm				
	Nominal-Diameter in mm				
	from 1 to 3	over 3 to 6	over 6 to 10	over 10 to 18	over 18 to 30
h10	0 - 40	0 - 48	0 - 58	0 - 70	0 - 84
h5	0 - 4	0 - 5	0 - 6	0 - 8	0 - 9

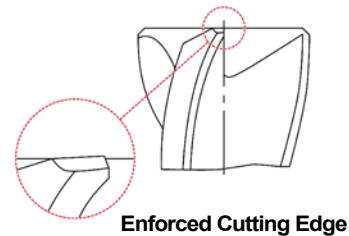

◎ : Excellent ○ : Good

ISO	P										M				K						
	Non-alloy steel					Low alloy steel					High alloyed steel, and tool steel				Stainless steel		Grey cast iron		Nodular cast iron		Malleable cast iron
Material Description	1	2	3	4	5	6	7	8	9	10	11	12	13	14	15	16	17	18	19	20	
VDI 3323	1	2	3	4	5	6	7	8	9	10	11	12	13	14	15	16	17	18	19	20	
HRc	13	25	28	32	30	29	32	38	35	35	35	23	10	10	10	26	3	25	42	55	
HB	125	190	250	270	300	180	275	300	350	200	325	200	240	180	180	260	160	250	130	230	
Recommend	○	○	◎	◎	◎	○	◎	◎	◎	○	◎	○	○	◎	○	◎	○	○	○	○	
ISO	N					S										H					
	Aluminum-wrought alloy		Aluminum-cast, alloyed			Copper and Copper Alloys (Bronze / Brass)			Non Metallic Materials		Heat Resistant Super Alloys					Titanium Alloys		Hardened steel	Chilled Cast Iron	Hardened Cast Iron	
Material Description	21	22	23	24	25	26	27	28	29	30	31	32	33	34	35	36	37	38	39	40	41
VDI 3323	21	22	23	24	25	26	27	28	29	30	31	32	33	34	35	36	37	38	39	40	41
HRc	60	100	75	90	130	110	90	100			200	280	250	350	320	400 Rm	1050 Rm	550	630	400	550
HB	60	100	75	90	130	110	90	100			200	280	250	350	320	400 Rm	1050 Rm	550	630	400	550
Recommend	○	○	○	○	○	○	○	○	○	○	○	○	○	○	○	◎	◎	○	○	○	○

- CBN END MILLS
- i-Xmill END MILLS
- i-SMART MODULAR END MILLS
- X5070 END MILLS
- 4G MILL END MILLS
- X-POWER PRO END MILLS
- TitaNox-POWER END MILLS
- JET-POWER END MILLS
- V7 PLUS END MILLS
- ALU-POWER HPC END MILLS
- ALU-POWER END MILLS
- D-POWER GRAPHITE END MILLS
- D-POWER CFRP END MILLS
- ROUTERS
- CRX S END MILLS
- K-2 END MILLS
- ONLY ONE COATED PM60 END MILLS
- TANK-POWER END MILLS
- GENERAL HSS END MILLS
- MILLING CUTTERS
- TECHNICAL DATA

CARBIDE, MULTI FLUTE 45° HELIX LONG LENGTH ROUGHING - FINE

- **VOLLHARTMETALL, MULTI SCHNEIDEN 45° RECHTSSPIRALE LANG SCHRUPPFÄRER - FEIN**
- **Fraise carbure, multi-dents ébauche, hélice 45°, pas fin, longue**
- **MULTITAGLIENTI, ELICA 45°, PER SGROSSATURA, LUNGA - Bombato fine**

- ▶ Ultra micro grain carbide
- ▶ High chip removal and minimizing breakages of cutting edges.
- ▶ Suitable for low hardness materials(under HRC45), alloy steels, tool steels, carbon steels, prehardened steels, stainless steels, etc

- ▶ Ultra Feinstkorn - Vollhartmetall
- ▶ Schnelle Spanausfuhr und Minimierung von Abbrechen von Schneidkanten.
- ▶ zur Bearbeitung von: Werkstoffen bis 45 HRC, rostfreien Stählen, Titan und Nickellegierungen.

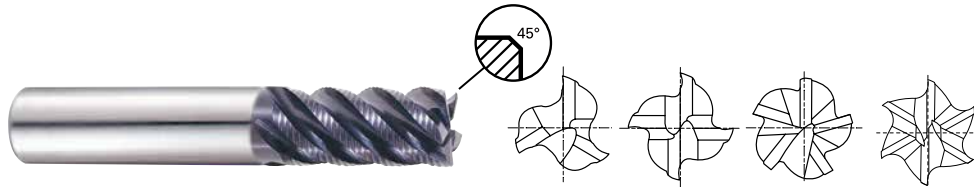

P.436-437

Unit : mm

EDP No.		Mill Diameter	Shank Diameter	Length of Cut	Overall Length	No. of Flute	Chamfer
PLAIN	FLAT	h10	h5				
EH919040	EH920040	4.0	6	11	57	3	0.1
EH919050	EH920050	5.0	6	13	57	4	0.13
EH919060	EH920060	6.0	6	16	57	4	0.15
EH919070	EH920070	7.0	8	16	63	4	0.15
EH919080	EH920080	8.0	8	16	63	4	0.18
EH919090	EH920090	9.0	10	19	72	4	0.18
EH919100	EH920100	10.0	10	22	72	4	0.2
EH919120	EH920120	12.0	12	26	83	4	0.2
EH919140	EH920140	14.0	14	26	83	5	0.2
EH919160	EH920160	16.0	16	32	92	5	0.2
EH919200	EH920200	20.0	20	38	104	6	0.2
EH919250	EH920250	25.0	25	45	121	6	0.2

Tolerances according to DIN 7160 & 7161

Tolerance range in μm					
Nominal-Diameter in mm					
	from 1 to 3	over 3 to 6	over 6 to 10	over 10 to 18	over 18 to 30
h10	0 -40	0 -48	0 -58	0 -70	0 -84
h5	0 -4	0 -5	0 -6	0 -8	0 -9

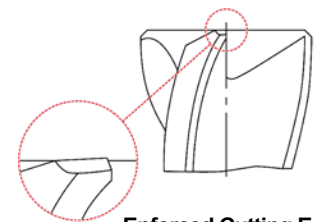

Enforced Cutting Edge

◎ : Excellent ○ : Good

ISO Material Description	P										M			K							
	Non-alloy steel					Low alloy steel					High alloyed steel, and tool steel			Stainless steel			Grey cast iron		Nodular cast iron		Malleable cast iron
VDI 3323	1	2	3	4	5	6	7	8	9	10	11	12	13	14	15	16	17	18	19	20	
HRc	13	25	28	32	36	10	29	32	38	15	35	15	23	10	10	26	3	25	42	21	
HB	125	190	250	270	300	180	275	300	350	200	325	200	240	180	180	260	160	250	130	230	
Recommend	○	○	◎	◎	◎	○	◎	◎	◎	○	◎	○	○	◎	○	◎	○	◎	○	◎	
ISO Material Description	N									S							H				
	Aluminum- wrought alloy		Aluminum-cast, alloyed			Copper and Copper Alloys (Bronze / Brass)		Non Metallic Materials		Heat Resistant Super Alloys			Titanium Alloys				Hardened steel	Chilled Cast Iron	Hardened Cast Iron		
VDI 3323	21	22	23	24	25	26	27	28	29	30	31	32	33	34	35	36	37	38	39	40	41
HRc	60	100	75	90	130	110	90	100			15	30	25	38	34			55	60	42	55
HB	60	100	75	90	130	110	90	100			200	280	250	350	320	400 Rm	1050 Rm	550	630	400	550
Recommend	○	○	○	○	○	○	○	○	○	○	○	○	○	○	○	◎	◎	○	○	○	○

CARBIDE, MULTI FLUTE 45° HELIX LONG REACH ROUGHING - FINE
 ● VOLLHARTMETALL, MULTI SCHNEIDEN 45° RECHTSSPIRALE GROÙE REICHWEITE SCHRUPPFRÄSER - FEIN
 () Fraise carbure, multi-dents ébauche longue portée, hélice 45°, pas fin
 () MULTITAGLIENTI, ELICA 45° SCARICATA, PER SGROSSATURA, LUNGA - Bombato fine

- ▶ Ultra micro grain carbide
- ▶ High chip removal and minimizing breakages of cutting edges.
- ▶ Suitable for low hardness materials(under HRc45), alloy steels, tool steels, carbon steels, prehardened steels, stainless steels, etc

- ▶ Ultra Feinstkorn - Vollhartmetall
- ▶ Schnelle Spanausfuhr und Minimierung von Abbrechen von Schneidkanten.
- ▶ zur Bearbeitung von: Werkstoffen bis 45 HRc, rostfreien Stählen, Titan und Nickellegierungen.

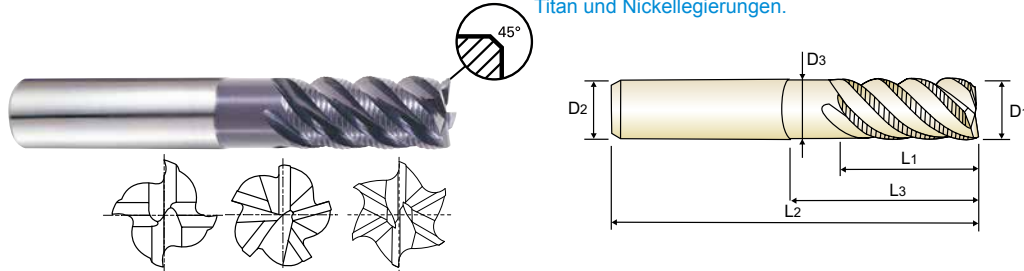

CARBIDE HR 4-6 45° PLAIN FLAT C x 45° P.434-435

EDP No.		Mill Diameter	Shank Diameter	Length of Cut	Length Below Shank	Overall Length	Neck Diameter	No. of Flute	Chamfer
PLAIN	FLAT	D1(h10)	D2(h5)	L1	L3	L2	D3		
EH921060	EH942060	6.0	6	16	20	57	5.5	4	0.15
EH921080	EH942080	8.0	8	16	26	63	7.5	4	0.18
EH921100	EH942100	10.0	10	22	31	72	9.5	4	0.2
EH921120	EH942120	12.0	12	26	37	83	11.5	4	0.2
EH921160	EH942160	16.0	16	32	51	100	15.5	5	0.2
EH921200	EH942200	20.0	20	38	59	110	19.2	6	0.2

Unit : mm

Tolerances according to DIN 7160 & 7161

Tolerance range in μm					
Nominal-Diameter in mm					
	from 1 to 3	over 3 to 6	over 6 to 10	over 10 to 18	over 18 to 30
h10	0 - 40	0 - 48	0 - 58	0 - 70	0 - 84
h5	0 - 4	0 - 5	0 - 6	0 - 8	0 - 9

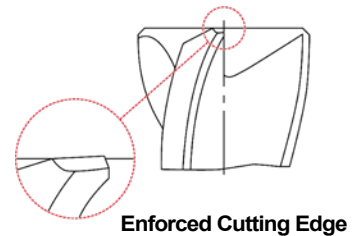

◎ : Excellent ○ : Good

ISO	P										M				K						
	Non-alloy steel					Low alloy steel					High alloyed steel, and tool steel				Stainless steel		Grey cast iron		Nodular cast iron		Malleable cast iron
Material Description	1	2	3	4	5	6	7	8	9	10	11	12	13	14	15	16	17	18	19	20	
VDI 3323	1	2	3	4	5	6	7	8	9	10	11	12	13	14	15	16	17	18	19	20	
HRc		13	25	28	32	10	29	32	38	15	35	15	23	10	10	26	3	25	42	21	
HB	125	190	250	270	300	180	275	300	350	200	325	200	240	180	180	260	160	250	130	230	
Recommend	○	○	◎	◎	◎	○	◎	◎	◎	○	◎	○	○	◎	○	◎	○	◎	○	◎	
ISO	N					S					H										
	Aluminum-wrought alloy		Aluminum-cast, alloyed			Copper and Copper Alloys (Bronze / Brass)		Non Metallic Materials			Heat Resistant Super Alloys			Titanium Alloys		Hardened steel	Chilled Cast Iron	Hardened Cast Iron			
Material Description	21	22	23	24	25	26	27	28	29	30	31	32	33	34	35	36	37	38	39	40	41
VDI 3323	21	22	23	24	25	26	27	28	29	30	31	32	33	34	35	36	37	38	39	40	41
HRc											15	30	25	38	34	55	60	55	60	42	55
HB	60	100	75	90	130	110	90	100			200	280	250	350	320	400 Rm	1050 Rm	550	630	400	550
Recommend											○	○	○	○	○	◎	◎	○	○	○	○

EH911, EH912 SERIES 2 FLUTE - SLOTTING

Vc = m/min.
fz = mm/tooth
RPM = rev./min.
FEED = mm/min.

ISO	VDI 3323	Material Description	Ae	Ap	Parameter	Diameter (Ø)										
						2.0	3.0	4.0	5.0	6.0	8.0	10.0	12.0	16.0	20.0	25.0
P	1-4	Non-alloy steel	1.0D	0.5D (up to Ø3:0.2D)	Vc	75	85	95	100	105	105	100	105	110	105	105
					fz	0.008	0.012	0.02	0.025	0.031	0.045	0.051	0.051	0.05	0.051	0.048
	RPM	11937	9019	7560	6366	5570	4178	3183	2785	2188	1671	1337				
	FEED	191	216	302	318	345	376	325	284	219	170	128				
	5	Non-alloy steel	1.0D	0.5D (up to Ø3:0.2D)	Vc	50	50	60	60	65	65	65	65	70	65	65
					fz	0.008	0.013	0.019	0.025	0.033	0.04	0.04	0.039	0.04	0.038	0.042
RPM	7958	5305	4775	3820	3448	2586	2069	1724	1393	1035	828					
FEED	127	138	181	191	228	207	166	134	111	79	70					
6-7	Low alloy steel	1.0D	0.5D (up to Ø3:0.2D)	Vc	75	85	95	100	105	105	100	105	110	105	105	
				fz	0.008	0.012	0.02	0.025	0.031	0.045	0.051	0.051	0.05	0.051	0.048	
RPM	11937	9019	7560	6366	5570	4178	3183	2785	2188	1671	1337					
FEED	191	216	302	318	345	376	325	284	219	170	128					
8-9	Low alloy steel	1.0D	0.5D (up to Ø3:0.2D)	Vc	50	50	60	60	65	65	65	65	70	65	65	
				fz	0.008	0.013	0.019	0.025	0.033	0.04	0.04	0.039	0.04	0.038	0.042	
RPM	7958	5305	4775	3820	3448	2586	2069	1724	1393	1035	828					
FEED	127	138	181	191	228	207	166	134	111	79	70					
10	High alloyed steel, and tool steel	1.0D	0.5D (up to Ø3:0.2D)	Vc	75	85	95	100	105	105	100	105	110	105	105	
				fz	0.008	0.012	0.02	0.025	0.031	0.045	0.051	0.051	0.05	0.051	0.048	
RPM	11937	9019	7560	6366	5570	4178	3183	2785	2188	1671	1337					
FEED	191	216	302	318	345	376	325	284	219	170	128					
11.1 - 11.2	High alloyed steel, and tool steel	1.0D	0.5D (up to Ø3:0.2D)	Vc	50	50	60	60	65	65	65	65	70	65	65	
				fz	0.008	0.013	0.019	0.025	0.033	0.04	0.04	0.039	0.04	0.038	0.042	
RPM	7958	5305	4775	3820	3448	2586	2069	1724	1393	1035	828					
FEED	127	138	181	191	228	207	166	134	111	79	70					
M	14.1	Stainless steel	1.0D	0.5D (up to Ø3:0.2D)	Vc	40	45	50	50	55	55	55	50	55	55	
fz	0.007	0.013	0.019	0.025	0.032	0.043	0.048	0.048	0.052	0.048	0.044					
RPM	6366	4775	3979	3183	2918	2188	1751	1326	1094	875	700					
FEED	89	124	151	159	187	188	168	127	114	84	62					
S	36-37	Titanium Alloys	1.0D	0.5D (up to Ø3:0.2D)	Vc	40	45	50	50	55	55	55	50	55	55	
fz	0.007	0.013	0.019	0.025	0.032	0.043	0.048	0.048	0.052	0.048	0.044					
RPM	6366	4775	3979	3183	2918	2188	1751	1326	1094	875	700					
FEED	89	124	151	159	187	188	168	127	114	84	62					
H	40	Chilled Cast Iron	1.0D	0.5D (up to Ø3:0.2D)	Vc	50	50	60	60	65	65	65	70	65	65	
fz	0.008	0.013	0.019	0.025	0.033	0.04	0.04	0.039	0.04	0.038	0.042					
RPM	7958	5305	4775	3820	3448	2586	2069	1724	1393	1035	828					
FEED	127	138	181	191	228	207	166	134	111	79	70					

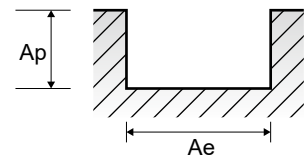

EH913, EH914 SERIES

4 FLUTE - SIDE CUTTING

Vc = m/min.
fz = mm/tooth
RPM = rev./min.
FEED = mm/min.

ISO	VDI 3323	Material Description	Ae	Ap	Parameter	Diameter (Ø)											
						2.0	3.0	4.0	5.0	6.0	8.0	10.0	12.0	16.0	20.0	25.0	
P	1-4	Non-alloy steel	0.05D	1.0D	Vc	75	85	95	100	105	105	100	105	110	105	105	
					fz	0.006	0.009	0.019	0.024	0.03	0.042	0.047	0.047	0.047	0.048	0.046	
					RPM	11937	9019	7560	6366	5570	4178	3183	2785	2188	1671	1337	
	FEED		286	325	575	611	668	702	598	524	411	321	246				
	5		Low alloy steel	0.05D	1.0D	Vc	50	50	60	60	65	65	65	65	70	65	65
						fz	0.006	0.009	0.019	0.024	0.031	0.038	0.038	0.037	0.037	0.038	0.039
		RPM				7958	5305	4775	3820	3448	2586	2069	1724	1393	1035	828	
	FEED	191		191	363	367	428	393	314	255	206	157	129				
	6-7	High alloyed steel, and tool steel		0.05D	1.0D	Vc	75	85	95	100	105	105	100	105	110	105	105
						fz	0.006	0.009	0.019	0.024	0.03	0.042	0.047	0.047	0.047	0.048	0.046
			RPM			11937	9019	7560	6366	5570	4178	3183	2785	2188	1671	1337	
	FEED		286	325	575	611	668	702	598	524	411	321	246				
8-9	Stainless steel		0.05D	1.0D	Vc	50	50	60	60	65	65	65	65	70	65	65	
					fz	0.006	0.009	0.019	0.024	0.031	0.038	0.038	0.037	0.037	0.038	0.039	
		RPM			7958	5305	4775	3820	3448	2586	2069	1724	1393	1035	828		
FEED		191	191	363	367	428	393	314	255	206	157	129					
10		Titanium Alloys	0.05D	1.0D	Vc	75	85	95	100	105	105	100	105	110	105	105	
					fz	0.006	0.009	0.019	0.024	0.03	0.042	0.047	0.047	0.047	0.048	0.046	
	RPM				11937	9019	7560	6366	5570	4178	3183	2785	2188	1671	1337		
FEED	286		325	575	611	668	702	598	524	411	321	246					
11.1 - 11.2	Chilled Cast Iron		0.05D	1.0D	Vc	50	50	60	60	65	65	65	65	70	65	65	
					fz	0.006	0.009	0.019	0.024	0.031	0.038	0.038	0.037	0.037	0.038	0.039	
		RPM			7958	5305	4775	3820	3448	2586	2069	1724	1393	1035	828		
FEED		191	191	363	367	428	393	314	255	206	157	129					
M		14.1	Stainless steel	0.05D	1.0D	Vc	40	45	50	50	55	55	55	50	55	55	55
						fz	0.006	0.009	0.018	0.024	0.029	0.042	0.045	0.044	0.047	0.045	0.044
	RPM					6366	4775	3979	3183	2918	2188	1751	1326	1094	875	700	
	FEED					153	172	286	306	338	368	315	233	206	158	123	
36-37	Titanium Alloys	0.05D	1.0D	Vc	40	45	50	50	55	55	55	50	55	55	55		
				fz	0.006	0.009	0.018	0.024	0.029	0.042	0.045	0.044	0.047	0.045	0.044		
				RPM	6366	4775	3979	3183	2918	2188	1751	1326	1094	875	700		
				FEED	153	172	286	306	338	368	315	233	206	158	123		
40	Chilled Cast Iron	0.05D	1.0D	Vc	50	50	60	60	65	65	65	65	70	65	65		
				fz	0.006	0.009	0.019	0.024	0.031	0.038	0.038	0.037	0.037	0.038	0.039		
				RPM	7958	5305	4775	3820	3448	2586	2069	1724	1393	1035	828		
				FEED	191	191	363	367	428	393	314	255	206	157	129		

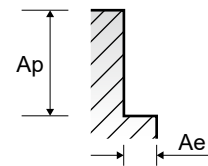

EH830, EH840 SERIES **3&4 FLUTE - SLOTTING**

Vc = m/min.
fz = mm/tooth
RPM = rev./min.
FEED = mm/min.

ISO	VDI 3323	Material Description	Ae	Ap	Parameter	Diameter (Ø)							
						6.0	8.0	10.0	12.0	16.0	18.0	20.0	25.0
P	1-4	Non-alloy steel	1.0D	0.5D	Vc	105	105	100	105	110	110	105	105
					fz	0.019	0.027	0.031	0.03	0.03	0.03	0.022	0.021
	RPM	5570	4178	3183	2785	2188	1945	1671	1337				
	FEED	318	338	296	251	197	175	147	112				
	5	Non-alloy steel	1.0D	0.5D	Vc	65	65	65	65	70	70	65	65
					fz	0.02	0.024	0.023	0.024	0.025	0.023	0.017	0.018
RPM	3448	2586	2069	1724	1393	1238	1035	828					
FEED	207	186	143	124	104	85	70	60					
6-7	Low alloy steel	1.0D	0.5D	Vc	105	105	100	105	110	110	105	105	
				fz	0.019	0.027	0.031	0.03	0.03	0.03	0.022	0.021	
RPM	5570	4178	3183	2785	2188	1945	1671	1337					
FEED	318	338	296	251	197	175	147	112					
8-9	Low alloy steel	1.0D	0.5D	Vc	65	65	65	65	70	70	65	65	
				fz	0.02	0.024	0.023	0.024	0.025	0.023	0.017	0.018	
RPM	3448	2586	2069	1724	1393	1238	1035	828					
FEED	207	186	143	124	104	85	70	60					
10	High alloyed steel, and tool steel	1.0D	0.5D	Vc	105	105	100	105	110	110	105	105	
				fz	0.019	0.027	0.031	0.03	0.03	0.03	0.022	0.021	
RPM	5570	4178	3183	2785	2188	1945	1671	1337					
FEED	318	338	296	251	197	175	147	112					
11.1 - 11.2	High alloyed steel, and tool steel	1.0D	0.5D	Vc	65	65	65	65	70	70	65	65	
				fz	0.02	0.024	0.023	0.024	0.025	0.023	0.017	0.018	
RPM	3448	2586	2069	1724	1393	1238	1035	828					
FEED	207	186	143	124	104	85	70	60					
M	14.1	Stainless steel	1.0D	0.5D	Vc	55	55	55	50	55	55	55	55
					fz	0.019	0.025	0.028	0.029	0.032	0.03	0.021	0.022
RPM	2918	2188	1751	1326	1094	973	875	700					
FEED	166	164	147	115	105	88	74	62					
S	31-35	Heat Resistant Super Alloys	1.0D	0.05D	Vc	20	20	20	20	20	20	20	20
					fz	0.011	0.016	0.02	0.018	0.02	0.018	0.016	0.014
RPM	1061	796	637	531	398	354	318	255					
FEED	35	38	38	29	24	19	20	14					
36-37	Titanium Alloys	1.0D	0.5D	Vc	55	55	55	50	55	55	55	55	
				fz	0.019	0.025	0.028	0.029	0.032	0.03	0.021	0.022	
RPM	2840	2100	1680	1370	1050	950	840	670					
FEED	160	160	140	120	100	85	70	60					
40	Chilled Cast Iron	1.0D	0.5D	Vc	65	65	65	65	70	70	65	65	
				fz	0.02	0.024	0.023	0.024	0.025	0.023	0.017	0.018	
RPM	3448	2586	2069	1724	1393	1238	1035	828					
FEED	207	186	143	124	104	85	70	60					

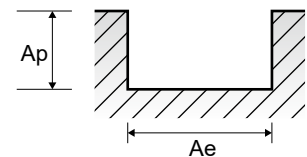

EH830, EH840 SERIES

3&4 FLUTE - SIDE CUTTING

Vc = m/min.
fz = mm/tooth
RPM = rev./min.
FEED = mm/min.

ISO	VDI 3323	Material Description	Ae	Ap	Parameter	Diameter (Ø)								
						6.0	8.0	10.0	12.0	16.0	18.0	20.0	25.0	
P	1-4	Non-alloy steel	0.5D	1.5D	Vc	105	105	100	105	110	110	105	105	
					fz	0.024	0.033	0.038	0.038	0.038	0.038	0.028	0.028	
	RPM		5570	4178	3183	2785	2188	1945	1671	1337				
	FEED		401	414	363	318	249	222	187	150				
	5		Low alloy steel	0.5D	1.5D	Vc	65	65	65	65	70	70	65	65
						fz	0.025	0.03	0.03	0.03	0.029	0.03	0.022	0.022
	RPM	3448		2586	2069	1724	1393	1238	1035	828				
	FEED	259		233	186	155	121	111	91	73				
	6-7	High alloyed steel, and tool steel		0.5D	1.5D	Vc	105	105	100	105	110	110	105	105
						fz	0.024	0.033	0.038	0.038	0.038	0.038	0.028	0.028
	RPM		5570	4178	3183	2785	2188	1945	1671	1337				
	FEED		401	414	363	318	249	222	187	150				
8-9	Stainless steel		0.5D	1.5D	Vc	65	65	65	65	70	70	65	65	
					fz	0.025	0.03	0.03	0.03	0.029	0.03	0.022	0.022	
RPM		3448	2586	2069	1724	1393	1238	1035	828					
FEED		259	233	186	155	121	111	91	73					
10		Heat Resistant Super Alloys	0.5D	1.5D	Vc	105	105	100	105	110	110	105	105	
					fz	0.024	0.033	0.038	0.038	0.038	0.038	0.028	0.028	
RPM	5570		4178	3183	2785	2188	1945	1671	1337					
FEED	401		414	363	318	249	222	187	150					
11.1 - 11.2	Titanium Alloys		0.5D	1.5D	Vc	65	65	65	65	70	70	65	65	
					fz	0.025	0.03	0.03	0.03	0.029	0.03	0.022	0.022	
RPM		3448	2586	2069	1724	1393	1238	1035	828					
FEED		259	233	186	155	121	111	91	73					
M		14.1	Chilled Cast Iron	0.5D	1.0D	Vc	55	55	55	50	55	55	55	55
						fz	0.029	0.042	0.046	0.044	0.048	0.046	0.034	0.034
	RPM					2918	2188	1751	1326	1094	973	875	700	
	FEED					254	276	242	175	158	134	119	95	
S	31-35	Heat Resistant Super Alloys	0.05D	1.0D	Vc	20	20	20	20	20	20	20	20	
					fz	0.017	0.02	0.025	0.027	0.028	0.027	0.022	0.023	
					RPM	1061	796	637	531	398	354	318	255	
					FEED	54	48	48	43	33	29	28	23	
S	36-37	Titanium Alloys	0.05D	1.0D	Vc	55	55	55	50	55	55	55	55	
					fz	0.029	0.042	0.046	0.044	0.048	0.046	0.034	0.034	
					RPM	2918	2188	1751	1326	1094	973	875	700	
					FEED	254	276	242	175	158	134	119	95	
	40	Chilled Cast Iron	0.5D	1.5D	Vc	65	65	65	65	70	70	65	65	
					fz	0.025	0.03	0.03	0.03	0.029	0.03	0.022	0.022	
					RPM	3448	2586	2069	1724	1393	1238	1035	828	
					FEED	259	233	186	155	121	111	91	73	

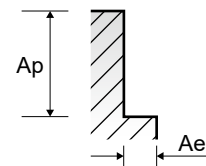

EH915, EH916 SERIES

6&8 FLUTE - SIDE CUTTING

Vc = m/min.
fz = mm/tooth
RPM = rev./min.
FEED = mm/min.

NORMAL SPEED

ISO	VDI 3323	Material Description	Ae	Ap	Parameter	Diameter (Ø)							
						6.0	8.0	10.0	12.0	16.0	20.0	25.0	
P	1-4	Non-alloy steel	0.1D	1.5D	Vc	105	105	105	105	105	105	120	
					fz	0.06	0.079	0.099	0.099	0.1	0.075	0.075	
	RPM		5570	4178	3342	2785	2089	1671	1528				
	FEED		2005	1980	1985	1654	1253	1003	917				
	5		Low alloy steel	0.05D	1.5D	Vc	75	75	75	75	75	75	85
						fz	0.059	0.078	0.098	0.097	0.099	0.074	0.068
	RPM	3979		2984	2387	1989	1492	1194	1082				
	FEED	1409		1397	1404	1158	886	707	589				
	6-7	High alloyed steel, and tool steel		0.1D	1.5D	Vc	105	105	105	105	105	105	120
						fz	0.06	0.079	0.099	0.099	0.1	0.075	0.075
	RPM		5570	4178	3342	2785	2089	1671	1528				
	FEED		2005	1980	1985	1654	1253	1003	917				
8-9	Stainless steel		0.05D	1.5D	Vc	75	75	75	75	75	75	85	
					fz	0.059	0.078	0.098	0.097	0.099	0.074	0.068	
RPM		3979	2984	2387	1989	1492	1194	1082					
FEED		1409	1397	1404	1158	886	707	589					
10		Heat Resistant Super Alloys	0.1D	1.5D	Vc	105	105	105	105	105	105	120	
					fz	0.06	0.079	0.099	0.099	0.1	0.075	0.075	
RPM	5570		4178	3342	2785	2089	1671	1528					
FEED	2005		1980	1985	1654	1253	1003	917					
11.1	Titanium Alloys		0.05D	1.5D	Vc	75	75	75	75	75	75	85	
					fz	0.059	0.078	0.098	0.097	0.099	0.074	0.068	
RPM		3979	2984	2387	1989	1492	1194	1082					
FEED		1409	1397	1404	1158	886	707	589					
11.2		Chilled Cast Iron	0.05D	1.5D	Vc	65	65	60	60	60	55	65	
					fz	0.054	0.074	0.095	0.104	0.111	0.086	0.079	
RPM	3448		2586	1910	1592	1194	875	828					
FEED	1117		1148	1089	993	795	602	523					
M	Heat Resistant Super Alloys		0.02D	1.0D	Vc	25	25	15	15	15	15	15	
					fz	0.035	0.047	0.106	0.104	0.102	0.078	0.077	
RPM		1326	995	477	398	298	239	191					
FEED		279	281	304	248	183	149	118					
S		Titanium Alloys	0.05D	1.5D	Vc	65	65	60	60	60	55	65	
					fz	0.054	0.074	0.095	0.104	0.111	0.086	0.079	
RPM	3448		2586	1910	1592	1194	875	828					
FEED	1117		1148	1089	993	795	602	523					
40	Chilled Cast Iron		0.05D	1.5D	Vc	75	75	75	75	75	75	85	
					fz	0.059	0.078	0.098	0.097	0.099	0.074	0.068	
RPM		3979	2984	2387	1989	1492	1194	1082					
FEED		1409	1397	1404	1158	886	707	589					

HIGH SPEED

ISO	VDI 3323	Material Description	Ae	Ap	Parameter	Diameter (Ø)							
						6.0	8.0	10.0	12.0	16.0	20.0	25.0	
P	1-4	Non-alloy steel	0.1D	1.5D	Vc	420	420	420	430	420	420	470	
					fz	0.060	0.079	0.100	0.099	0.100	0.075	0.075	
	RPM		22282	16711	13369	11406	8356	6685	5984				
	FEED		8021	7921	8021	6775	5013	4011	3591				
	5		Low alloy steel	0.05D	1.5D	Vc	315	315	315	315	315	315	355
						fz	0.060	0.081	0.100	0.100	0.100	0.076	0.075
	RPM	16711		12533	10027	8356	6267	5013	4520				
	FEED	6016		6091	6016	5013	3760	3048	2712				
	6-7	High alloyed steel, and tool steel		0.1D	1.5D	Vc	420	420	420	430	420	420	470
						fz	0.060	0.079	0.100	0.099	0.100	0.075	0.075
	RPM		22282	16711	13369	11406	8356	6685	5984				
	FEED		8021	7921	8021	6775	5013	4011	3591				
8-9	Stainless steel		0.05D	1.5D	Vc	315	315	315	315	315	315	355	
					fz	0.060	0.081	0.100	0.100	0.100	0.076	0.075	
RPM		16711	12533	10027	8356	6267	5013	4520					
FEED		6016	6091	6016	5013	3760	3048	2712					
10		Heat Resistant Super Alloys	0.1D	1.5D	Vc	420	420	420	430	420	420	470	
					fz	0.060	0.079	0.100	0.099	0.100	0.075	0.075	
RPM	22282		16711	13369	11406	8356	6685	5984					
FEED	8021		7921	8021	6775	5013	4011	3591					
11.1	Titanium Alloys		0.05D	1.5D	Vc	315	315	315	315	315	315	355	
					fz	0.060	0.081	0.100	0.100	0.100	0.076	0.075	
RPM		16711	12533	10027	8356	6267	5013	4520					
FEED		6016	6091	6016	5013	3760	3048	2712					
11.2		Chilled Cast Iron	0.05D	1.5D	Vc	315	315	315	315	315	315	355	
					fz	0.060	0.081	0.100	0.100	0.100	0.076	0.075	
RPM	16711		12533	10027	8356	6267	5013	4520					
FEED	6016		6091	6016	5013	3760	3048	2712					

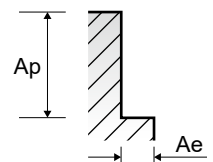

EH852
EH862 | **EH831**
EH841

MULTI FLUTES ROUGHING - SLOTTING

Vc = m/min.
fz = mm/tooth
RPM = rev./min.
FEED = mm/min.

ISO	VDI 3323	Material Description	Ae	Ap	Parameter	Diameter (Ø)								
						6.0	8.0	10.0	12.0	14.0	16.0	18.0	20.0	25.0
P	1-4	Non-alloy steel	1.0D	0.5D	Vc	294	292	289	302	299	302	294	302	338
					fz	0.03	0.04	0.038	0.045	0.053	0.06	0.067	0.068	0.06
	RPM	15597	11618	9199	8011	6798	6008	5199	4806	4304				
	FEED	1404	1394	1398	1442	1441	1442	1393	1307	1291				
	5	Non-alloy steel	1.0D	0.5D	Vc	234	231	239	226	229	241	249	226	251
					fz	0.013	0.018	0.016	0.02	0.024	0.024	0.024	0.024	0.023
	RPM	12414	9191	7608	5995	5207	4795	4403	3597	3196				
	FEED	484	496	487	480	500	460	423	345	368				
	6-7	Low alloy steel	1.0D	0.5D	Vc	294	292	289	302	299	302	294	302	338
					fz	0.03	0.04	0.038	0.045	0.053	0.06	0.067	0.068	0.06
RPM	15597	11618	9199	8011	6798	6008	5199	4806	4304					
FEED	1404	1394	1398	1442	1441	1442	1393	1307	1291					
8-9	Low alloy steel	1.0D	0.5D	Vc	234	231	239	226	229	241	249	226	251	
				fz	0.013	0.018	0.016	0.02	0.024	0.024	0.024	0.024	0.023	
RPM	12414	9191	7608	5995	5207	4795	4403	3597	3196					
FEED	484	496	487	480	500	460	423	345	368					
10	High alloyed steel, and tool steel	1.0D	0.5D	Vc	294	292	289	302	299	302	294	302	338	
				fz	0.03	0.04	0.038	0.045	0.053	0.06	0.067	0.068	0.06	
RPM	15597	11618	9199	8011	6798	6008	5199	4806	4304					
FEED	1404	1394	1398	1442	1441	1442	1393	1307	1291					
11.1 - 11.2	High alloyed steel, and tool steel	1.0D	0.5D	Vc	234	231	239	226	229	241	249	226	251	
				fz	0.013	0.018	0.016	0.02	0.024	0.024	0.024	0.024	0.023	
RPM	12414	9191	7608	5995	5207	4795	4403	3597	3196					
FEED	484	496	487	480	500	460	423	345	368					
M	14.1	Stainless steel	1.0D	Ø4 ~10:0.25D Ø12~16:0.15D Ø18~25:0.1D	Vc	158	158	160	158	158	166	153	151	170
fz	0.013	0.018	0.017	0.02	0.024	0.023	0.023	0.023	0.023					
RPM	8382	6287	5093	4191	3592	3302	2706	2403	2165					
FEED	327	339	346	335	345	304	249	221	249					
S	31-35	Heat Resistant Super Alloys	1.0D	0.05D	Vc	45	45	41	45	40	40	40	41	47
					fz	0.016	0.02	0.022	0.024	0.022	0.02	0.021	0.023	0.022
RPM	2387	1790	1305	1194	909	796	707	653	598					
FEED	115	107	115	115	80	64	59	60	66					
36-37	Titanium Alloys	1.0D	Ø4 ~10:0.25D Ø12~16:0.15D Ø18~25:0.1D	Vc	158	158	160	158	158	166	153	151	170	
				fz	0.013	0.018	0.017	0.02	0.024	0.023	0.023	0.023	0.023	
RPM	8382	6287	5093	4191	3592	3302	2706	2403	2165					
FEED	327	339	346	335	345	304	249	221	249					
40	Chilled Cast Iron	1.0D	0.5D	Vc	234	231	239	226	229	241	249	226	251	
				fz	0.013	0.018	0.016	0.02	0.024	0.024	0.024	0.024	0.023	
RPM	12414	9191	7608	5995	5207	4795	4403	3597	3196					
FEED	484	496	487	480	500	460	423	345	368					

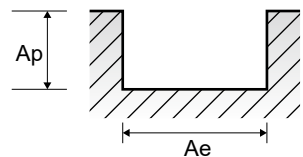

EH852 **EH831**
EH862 **EH841**

MULTI FLUTES ROUGHING - SIDE CUTTING

Vc = m/min.
fz = mm/tooth
RPM = rev./min.
FEED = mm/min.

ISO	VDI 3323	Material Description	Ae	Ap	Parameter	Diameter (Ø)									
						6.0	8.0	10.0	12.0	14.0	16.0	18.0	20.0	25.0	
P	1-4	Non-alloy steel	0.3D	1.5D	Vc	294	292	289	302	299	302	294	302	338	
					fz	0.05	0.067	0.063	0.075	0.088	0.1	0.112	0.113	0.1	
	RPM		15597	11618	9199	8011	6798	6008	5199	4806	4304				
	FEED		2340	2335	2318	2403	2393	2403	2329	2173	2152				
	Vc		234	231	239	226	229	241	249	226	251				
	fz		0.023	0.03	0.028	0.033	0.04	0.04	0.041	0.039	0.039				
	RPM	12414	9191	7608	5995	5207	4795	4403	3597	3196					
	FEED	857	827	852	791	833	767	722	561	623					
	5	Low alloy steel	0.3D	1.5D	Vc	294	292	289	302	299	302	294	302	338	
					fz	0.05	0.067	0.063	0.075	0.088	0.1	0.112	0.113	0.1	
	RPM		15597	11618	9199	8011	6798	6008	5199	4806	4304				
	FEED		2340	2335	2318	2403	2393	2403	2329	2173	2152				
Vc	234		231	239	226	229	241	249	226	251					
fz	0.023		0.03	0.028	0.033	0.04	0.04	0.041	0.039	0.039					
RPM	12414	9191	7608	5995	5207	4795	4403	3597	3196						
FEED	857	827	852	791	833	767	722	561	623						
6-7	High alloyed steel, and tool steel	0.3D	1.5D	Vc	294	292	289	302	299	302	294	302	338		
				fz	0.05	0.067	0.063	0.075	0.088	0.1	0.112	0.113	0.1		
RPM		15597	11618	9199	8011	6798	6008	5199	4806	4304					
FEED		2340	2335	2318	2403	2393	2403	2329	2173	2152					
Vc		234	231	239	226	229	241	249	226	251					
fz		0.023	0.03	0.028	0.033	0.04	0.04	0.041	0.039	0.039					
RPM	12414	9191	7608	5995	5207	4795	4403	3597	3196						
FEED	857	827	852	791	833	767	722	561	623						
8-9	Stainless steel	0.3D	1.5D	Vc	294	292	289	302	299	302	294	302	338		
				fz	0.05	0.067	0.063	0.075	0.088	0.1	0.112	0.113	0.1		
RPM		15597	11618	9199	8011	6798	6008	5199	4806	4304					
FEED		2340	2335	2318	2403	2393	2403	2329	2173	2152					
Vc		234	231	239	226	229	241	249	226	251					
fz		0.023	0.03	0.028	0.033	0.04	0.04	0.041	0.039	0.039					
RPM	12414	9191	7608	5995	5207	4795	4403	3597	3196						
FEED	857	827	852	791	833	767	722	561	623						
10	Heat Resistant Super Alloys	0.3D	1.5D	Vc	158	158	160	158	158	166	153	151	170		
				fz	0.023	0.03	0.028	0.034	0.04	0.039	0.039	0.038	0.038		
RPM		8382	6287	5093	4191	3592	3302	2706	2403	2165					
FEED		578	566	570	570	575	515	422	365	411					
Vc		45	45	41	45	40	40	40	41	47					
fz		0.026	0.033	0.037	0.04	0.036	0.034	0.036	0.038	0.037					
RPM	2387	1790	1305	1194	909	796	707	653	598						
FEED	186	177	193	191	131	108	102	99	111						
11.1 - 11.2	Titanium Alloys	0.3D	1.5D	Vc	158	158	160	158	158	166	153	151	170		
				fz	0.023	0.03	0.028	0.034	0.04	0.039	0.039	0.038	0.038		
RPM		8382	6287	5093	4191	3592	3302	2706	2403	2165					
FEED		578	566	570	570	575	515	422	365	411					
Vc		234	231	239	226	229	241	249	226	251					
fz		0.023	0.03	0.028	0.033	0.04	0.04	0.041	0.039	0.039					
RPM	12414	9191	7608	5995	5207	4795	4403	3597	3196						
FEED	857	827	852	791	833	767	722	561	623						
M 14.1	Chilled Cast Iron	0.3D	1.5D	Vc	234	231	239	226	229	241	249	226	251		
				fz	0.023	0.03	0.028	0.033	0.04	0.04	0.041	0.039	0.039		
RPM		12414	9191	7608	5995	5207	4795	4403	3597	3196					
FEED		857	827	852	791	833	767	722	561	623					
S 31-35		Stainless steel	0.05D	1.0D	Vc	158	158	160	158	158	166	153	151	170	
					fz	0.023	0.03	0.028	0.034	0.04	0.039	0.039	0.038	0.038	
RPM	8382		6287	5093	4191	3592	3302	2706	2403	2165					
FEED	578		566	570	570	575	515	422	365	411					
Vc	45		45	41	45	40	40	40	41	47					
fz	0.026		0.033	0.037	0.04	0.036	0.034	0.036	0.038	0.037					
RPM	2387	1790	1305	1194	909	796	707	653	598						
FEED	186	177	193	191	131	108	102	99	111						
S 36-37	Heat Resistant Super Alloys	0.05D	1.0D	Vc	158	158	160	158	158	166	153	151	170		
				fz	0.023	0.03	0.028	0.034	0.04	0.039	0.039	0.038	0.038		
RPM		8382	6287	5093	4191	3592	3302	2706	2403	2165					
FEED		578	566	570	570	575	515	422	365	411					
Vc		234	231	239	226	229	241	249	226	251					
fz		0.023	0.03	0.028	0.033	0.04	0.04	0.041	0.039	0.039					
RPM	12414	9191	7608	5995	5207	4795	4403	3597	3196						
FEED	857	827	852	791	833	767	722	561	623						

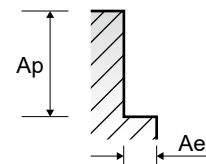

EH917 **EH921**
EH918 **EH942**

MULTI FLUTES ROUGHING - SLOTTING

Vc = m/min.
fz = mm/tooth
RPM = rev./min.
FEED = mm/min.

ISO	VDI 3323	Material Description	Ae	Ap	Parameter	Diameter (Ø)					
						6.0	8.0	10.0	12.0	16.0	20.0
P	1-4	Non-alloy steel	1.0D	0.5D	Vc	294	292	289	302	302	302
					fz	0.022	0.03	0.038	0.045	0.048	0.045
	5	Non-alloy steel	1.0D	0.5D	RPM	15597	11618	9199	8011	6008	4806
					FEED	1373	1394	1398	1442	1442	1298
	6-7	Low alloy steel	1.0D	0.5D	Vc	234	231	239	226	241	226
					fz	0.01	0.014	0.016	0.02	0.019	0.016
	8-9	Low alloy steel	1.0D	0.5D	RPM	12414	9191	7608	5995	4795	3597
					FEED	497	515	487	480	455	345
	10	High alloyed steel, and tool steel	1.0D	0.5D	Vc	294	292	289	302	302	302
					fz	0.022	0.03	0.038	0.045	0.048	0.045
	11.1 - 11.2	High alloyed steel, and tool steel	1.0D	0.5D	RPM	15597	11618	9199	8011	6008	4806
					FEED	1373	1394	1398	1442	1442	1298
M	14.1	Stainless steel	1.0D	0.5D	Vc	234	231	239	226	241	226
					fz	0.01	0.014	0.016	0.02	0.019	0.016
S	31-35	Heat Resistant Super Alloys	1.0D	0.5D	RPM	12414	9191	7608	5995	4795	3597
					FEED	497	515	487	480	455	345
S	36-37	Titanium Alloys	1.0D	0.5D	Vc	158	158	160	158	166	151
					fz	0.01	0.013	0.017	0.02	0.019	0.015
S	36-37	Titanium Alloys	1.0D	0.5D	RPM	8382	6287	5093	4191	3302	2403
					FEED	335	327	346	335	314	216
S	40	Chilled Cast Iron	1.0D	0.5D	Vc	45	45	41	45	40	41
					fz	0.012	0.015	0.022	0.024	0.016	0.015
S	40	Chilled Cast Iron	1.0D	0.5D	RPM	2387	1790	1305	1194	796	653
					FEED	115	107	115	115	64	59
S	40	Chilled Cast Iron	1.0D	0.5D	Vc	158	158	160	158	166	151
					fz	0.01	0.013	0.017	0.02	0.019	0.015
S	40	Chilled Cast Iron	1.0D	0.5D	RPM	8382	6287	5093	4191	3302	2403
					FEED	335	327	346	335	314	216
S	40	Chilled Cast Iron	1.0D	0.5D	Vc	234	231	239	226	241	226
					fz	0.01	0.014	0.016	0.02	0.019	0.016
S	40	Chilled Cast Iron	1.0D	0.5D	RPM	12414	9191	7608	5995	4795	3597
					FEED	372	386	487	480	455	345

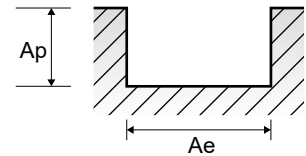

EH917 **EH921**
EH918 **EH942**

MULTI FLUTES ROUGHING - SIDE CUTTING

Vc = m/min.
fz = mm/tooth
RPM = rev./min.
FEED = mm/min.

ISO	VDI 3323	Material Description	Ae	Ap	Parameter	Diameter (Ø)					
						6.0	8.0	10.0	12.0	16.0	20.0
P	1-4	Non-alloy steel	0.3D	1.5D	Vc	294	292	289	302	302	302
					fz	0.037	0.05	0.063	0.075	0.08	0.075
	RPM				15597	11618	9199	8011	6008	4806	
	FEED				2308	2324	2318	2403	2403	2163	
	Vc				234	231	239	226	241	226	
	fz				0.017	0.023	0.028	0.033	0.032	0.026	
	5	Low alloy steel	0.3D	1.5D	RPM	12414	9191	7608	5995	4795	3597
					FEED	844	846	852	791	767	561
	Vc				294	292	289	302	302	302	
	fz				0.037	0.05	0.063	0.075	0.08	0.075	
	RPM				15597	11618	9199	8011	6008	4806	
	FEED				2308	2324	2318	2403	2403	2163	
6-7	High alloyed steel, and tool steel	0.3D	1.5D	Vc	234	231	239	226	241	226	
				fz	0.017	0.023	0.028	0.033	0.032	0.026	
RPM				12414	9191	7608	5995	4795	3597		
FEED				844	846	852	791	767	561		
Vc				294	292	289	302	302	302		
fz				0.037	0.05	0.063	0.075	0.08	0.075		
8-9	High alloyed steel, and tool steel	0.3D	1.5D	RPM	15597	11618	9199	8011	6008	4806	
				FEED	2308	2324	2318	2403	2403	2163	
Vc				234	231	239	226	241	226		
fz				0.017	0.023	0.028	0.033	0.032	0.026		
RPM				12414	9191	7608	5995	4795	3597		
FEED				844	846	852	791	767	561		
10	Stainless steel	0.3D	1.5D	Vc	158	158	160	158	166	151	
				fz	0.017	0.023	0.028	0.034	0.031	0.025	
RPM				8382	6287	5093	4191	3302	2403		
FEED				570	578	570	570	512	360		
Vc				45	45	41	45	40	41		
fz				0.02	0.025	0.037	0.04	0.028	0.025		
11.1 - 11.2	Heat Resistant Super Alloys	0.05D	1.0D	RPM	2387	1790	1305	1194	796	653	
				FEED	191	179	193	191	111	98	
Vc				158	158	160	158	166	151		
fz				0.017	0.023	0.028	0.034	0.031	0.025		
RPM				8382	6287	5093	4191	3302	2403		
FEED				570	578	570	570	512	360		
M	Titanium Alloys	0.3D	1.5D	Vc	234	231	239	226	241	226	
				fz	0.017	0.023	0.028	0.033	0.032	0.026	
RPM				12414	9191	7608	5995	4795	3597		
FEED				844	846	852	791	767	561		
Vc				158	158	160	158	166	151		
fz				0.017	0.023	0.028	0.034	0.031	0.025		
S	Chilled Cast Iron	0.3D	1.5D	RPM	8382	6287	5093	4191	3302	2403	
				FEED	570	578	570	570	512	360	
Vc				234	231	239	226	241	226		
fz				0.017	0.023	0.028	0.033	0.032	0.026		
RPM				12414	9191	7608	5995	4795	3597		
FEED				844	846	852	791	767	561		

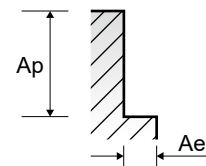

EH919, EH920 SERIES

MULTI FLUTES ROUGHING - SLOTTING

Vc = m/min.
fz = mm/tooth
RPM = rev./min.
FEED = mm/min.

ISO	VDI 3323	Material Description	Ae	Ap	Parameter	Diameter (Ø)									
						4.0	6.0	8.0	10.0	12.0	14.0	16.0	20.0	25.0	
P	1-4	Non-alloy steel	1.0D	0.5D	Vc	294	294	292	289	302	299	302	302	338	
					fz	0.02	0.022	0.03	0.038	0.045	0.042	0.048	0.045	0.05	
	RPM	23396	15597	11618	9199	8011	6798	6008	4806	4304					
	FEED	1404	1373	1394	1398	1442	1428	1442	1298	1291					
	5	Non-alloy steel	1.0D	0.5D	Vc	234	234	231	239	226	229	241	226	251	
					fz	0.009	0.01	0.014	0.016	0.02	0.019	0.019	0.016	0.019	
	RPM	18621	12414	9191	7608	5995	5207	4795	3597	3196					
	FEED	503	497	515	487	480	495	455	345	364					
	6-7	Low alloy steel	1.0D	0.5D	Vc	294	294	292	289	302	299	302	302	338	
					fz	0.02	0.022	0.03	0.038	0.045	0.042	0.048	0.045	0.05	
RPM	23396	15597	11618	9199	8011	6798	6008	4806	4304						
FEED	1404	1373	1394	1398	1442	1428	1442	1298	1291						
8-9	Low alloy steel	1.0D	0.5D	Vc	234	234	231	239	226	229	241	226	251		
				fz	0.009	0.01	0.014	0.016	0.02	0.019	0.019	0.016	0.019		
RPM	18621	12414	9191	7608	5995	5207	4795	3597	3196						
FEED	503	497	515	487	480	495	455	345	364						
10	High alloyed steel, and tool steel	1.0D	0.5D	Vc	294	294	292	289	302	299	302	302	338		
				fz	0.02	0.022	0.03	0.038	0.045	0.042	0.048	0.045	0.05		
RPM	23396	15597	11618	9199	8011	6798	6008	4806	4304						
FEED	1404	1373	1394	1398	1442	1428	1442	1298	1291						
11.1 - 11.2	High alloyed steel, and tool steel	1.0D	0.5D	Vc	234	234	231	239	226	229	241	226	251		
				fz	0.009	0.01	0.014	0.016	0.02	0.019	0.019	0.016	0.019		
RPM	18621	12414	9191	7608	5995	5207	4795	3597	3196						
FEED	503	497	515	487	480	495	455	345	364						
M	14.1	Stainless steel	1.0D	Ø4 ~10:0.25D Ø12~16:0.15D Ø18~25:0.10D	Vc	158	158	158	160	158	158	166	151	170	
fz	0.009	0.01	0.013	0.017	0.02	0.019	0.019	0.015	0.019						
RPM	12573	8382	6287	5093	4191	3592	3302	2403	2165						
FEED	339	335	327	346	335	341	314	216	247						
S	31-35	Heat Resistant Super Alloys	1.0D	0.05D	Vc	45	45	45	41	45	40	40	41	47	
					fz	0.011	0.012	0.015	0.022	0.024	0.018	0.016	0.015	0.018	
RPM	3581	2387	1790	1305	1194	909	796	653	598						
FEED	118	115	107	115	115	82	64	59	65						
36-37	Titanium Alloys	1.0D	Ø4 ~10:0.25D Ø12~16:0.15D Ø18~25:0.10D	Vc	158	158	158	160	158	158	166	151	170		
				fz	0.009	0.01	0.013	0.017	0.02	0.019	0.019	0.015	0.019		
RPM	12573	8382	6287	5093	4191	3592	3302	2403	2165						
FEED	339	335	327	346	335	341	314	216	247						
40	Chilled Cast Iron	1.0D	0.5D	Vc	234	234	231	239	226	229	241	226	251		
				fz	0.009	0.01	0.014	0.016	0.02	0.019	0.019	0.016	0.019		
RPM	18621	12414	9191	7608	5995	5207	4795	3597	3196						
FEED	503	497	515	487	480	495	455	345	364						

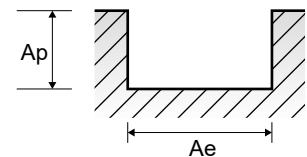

EH919, EH920 SERIES

MULTI FLUTES ROUGHING - SIDE CUTTING

Vc = m/min.
fz = mm/tooth
RPM = rev./min.
FEED = mm/min.

ISO	VDI 3323	Material Description	Ae	Ap	Parameter	Diameter (Ø)									
						4.0	6.0	8.0	10.0	12.0	14.0	16.0	20.0	25.0	
P	1-4	Non-alloy steel	0.3D	1.5D	Vc	294	294	292	289	302	299	302	302	338	
					fz	0.033	0.037	0.05	0.063	0.075	0.071	0.08	0.075	0.083	
	RPM				23396	15597	11618	9199	8011	6798	6008	4806	4304		
	FEED				2316	2308	2324	2318	2403	2413	2403	2163	2143		
	Vc				234	234	231	239	226	229	241	226	251		
	fz				0.015	0.017	0.023	0.028	0.033	0.032	0.032	0.026	0.032		
	RPM	18621	12414	9191	7608	5995	5207	4795	3597	3196					
	FEED	838	844	846	852	791	833	767	561	614					
	5	Low alloy steel	0.3D	1.5D	Vc	294	294	292	289	302	299	302	302	338	
					fz	0.033	0.037	0.05	0.063	0.075	0.071	0.08	0.075	0.083	
	RPM				23396	15597	11618	9199	8011	6798	6008	4806	4304		
	FEED				2316	2308	2324	2318	2403	2413	2403	2163	2143		
Vc	234				234	231	239	226	229	241	226	251			
fz	0.015				0.017	0.023	0.028	0.033	0.032	0.032	0.026	0.032			
RPM	18621	12414	9191	7608	5995	5207	4795	3597	3196						
FEED	838	844	846	852	791	833	767	561	614						
6-7	High alloyed steel, and tool steel	0.3D	1.5D	Vc	294	294	292	289	302	299	302	302	338		
				fz	0.033	0.037	0.05	0.063	0.075	0.071	0.08	0.075	0.083		
RPM				23396	15597	11618	9199	8011	6798	6008	4806	4304			
FEED				2316	2308	2324	2318	2403	2413	2403	2163	2143			
Vc				234	234	231	239	226	229	241	226	251			
fz				0.015	0.017	0.023	0.028	0.033	0.032	0.032	0.026	0.032			
RPM	18621	12414	9191	7608	5995	5207	4795	3597	3196						
FEED	838	844	846	852	791	833	767	561	614						
8-9	Stainless steel	0.3D	1.5D	Vc	158	158	158	160	158	158	166	151	170		
				fz	0.015	0.017	0.023	0.028	0.034	0.032	0.031	0.025	0.032		
RPM				12573	8382	6287	5093	4191	3592	3302	2403	2165			
FEED				566	570	578	570	570	575	512	360	416			
Vc				45	45	45	41	45	40	40	41	47			
fz				0.018	0.02	0.025	0.037	0.04	0.029	0.028	0.025	0.031			
RPM	3581	2387	1790	1305	1194	909	796	653	598						
FEED	193	191	179	193	191	132	111	98	111						
10	Titanium Alloys	0.3D	1.5D	Vc	158	158	158	160	158	158	166	151	170		
				fz	0.015	0.017	0.023	0.028	0.034	0.032	0.031	0.025	0.032		
RPM				12573	8382	6287	5093	4191	3592	3302	2403	2165			
FEED				566	570	578	570	570	575	512	360	416			
Vc				234	234	231	239	226	229	241	226	251			
fz				0.015	0.017	0.023	0.028	0.033	0.032	0.032	0.026	0.032			
RPM	18621	12414	9191	7608	5995	5207	4795	3597	3196						
FEED	838	844	846	852	791	833	767	561	614						
11.1 - 11.2	Chilled Cast Iron	0.3D	1.5D	Vc	158	158	158	160	158	158	166	151	170		
				fz	0.015	0.017	0.023	0.028	0.034	0.032	0.031	0.025	0.032		
RPM				12573	8382	6287	5093	4191	3592	3302	2403	2165			
FEED				566	570	578	570	570	575	512	360	416			
Vc				234	234	231	239	226	229	241	226	251			
fz				0.015	0.017	0.023	0.028	0.033	0.032	0.032	0.026	0.032			
RPM	18621	12414	9191	7608	5995	5207	4795	3597	3196						
FEED	838	844	846	852	791	833	767	561	614						
M	31-35	Heat Resistant Super Alloys	0.05D	1.0D	Vc	45	45	45	41	45	40	40	41	47	
					fz	0.018	0.02	0.025	0.037	0.04	0.029	0.028	0.025	0.031	
RPM					3581	2387	1790	1305	1194	909	796	653	598		
FEED					193	191	179	193	191	132	111	98	111		
Vc					158	158	158	160	158	158	166	151	170		
fz					0.015	0.017	0.023	0.028	0.034	0.032	0.031	0.025	0.032		
RPM	12573	8382	6287	5093	4191	3592	3302	2403	2165						
FEED	566	570	578	570	570	575	512	360	416						
S	36-37	Titanium Alloys	0.3D	1.5D	Vc	234	234	231	239	226	229	241	226	251	
					fz	0.015	0.017	0.023	0.028	0.033	0.032	0.032	0.026	0.032	
RPM					18621	12414	9191	7608	5995	5207	4795	3597	3196		
FEED					838	844	846	852	791	833	767	561	614		
Vc					234	234	231	239	226	229	241	226	251		
fz					0.015	0.017	0.023	0.028	0.033	0.032	0.032	0.026	0.032		
RPM	18621	12414	9191	7608	5995	5207	4795	3597	3196						
FEED	838	844	846	852	791	833	767	561	614						

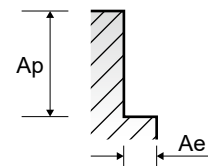



Global Cutting Tool Leader **YG-1**



MILLING



Leading Through Innovation



SOLID CARBIDE

V7 PLUS END MILLS

V7 Plus VHM - Schaftfräser

- High Performance Carbide End Mills for Steels, Cast Iron and Stainless Steels

- Hochleistungs-VHM-Schaftfräser für Stähle, Gusseisen und rostfreie Stähle

SELECTION GUIDE

HSS



SERIES	GMG55 GMG56	GMF54 GMF55	GMF58 GMF59
FLUTE	4	4	4
HELIX ANGLE	35°/37° (MULTIPLE HELIX)	35°/37° (MULTIPLE HELIX)	35°/37° (MULTIPLE HELIX)
CUTTING EDGE SHAPE	BALL NOSE	CORNER RADIUS	CORNER RADIUS
SIZE MIN	R1.5	D3.0	D3.0
SIZE MAX	R12.5	D20.0	D25.0
PAGE	442	443	444

CBN
END MILLS

i-Xmill
END MILLS

i-SMART
MODULAR
END MILLS

X5070
END MILLS

4G MILL
END MILLS

X-POWER
PRO
END MILLS

TitaNox-
POWER
END MILLS

JET-POWER
END MILLS

V7 PLUS
END MILLS

ALU-POWER
HPC
END MILLS

ALU-
POWER
END MILLS

D-POWER
GRAPHITE
END MILLS

D-POWER
CFRP
END MILLS

ROUTERS

CRX S
END MILLS

K-2
END MILLS

ONLY ONE
COATED PM60
END MILLS

TANK-
POWER
END MILLS

GENERAL
HSS
END MILLS

MILLING
CUTTERS

TECHNICAL
DATA

SOLID CARBIDE
V7 PLUS
END MILLS

High performance carbide end mills for Steels, Cast Iron and Stainless Steels



Please visit globalyg1.com/mat for material search

◎ : Excellent ○ : Good

Recommended cutting conditions : P 458

LONG LENGTH	SHORT LENGTH	LONG LENGTH
Y-Coating	Y-Coating	Y-Coating



ISO	VDI 3323	Material Description	Composition / Structure / Heat Treatment	HB	HRc				
P	1	Non-alloy steel	About 0.15% C Annealed	125		◎	◎	◎	
	2		About 0.45% C Annealed	190	13	◎	◎	◎	
	3		About 0.45% C Quenched & Tempered	250	25	◎	◎	◎	
	4		About 0.75% C Annealed	270	28	◎	◎	◎	
	5		About 0.75% C Quenched & Tempered	300	32	◎	◎	◎	
	6	Low alloy steel	Annealed	180	10	◎	◎	◎	
	7		Quenched & Tempered	275	29	◎	◎	◎	
	8		Quenched & Tempered	300	32	◎	◎	◎	
	9		Quenched & Tempered	350	38	◎	◎	◎	
	10		High alloyed steel, and tool steel	Annealed	200	15	◎	◎	◎
	11			Quenched & Tempered	325	35	◎	◎	◎
M	12	Stainless steel	Ferritic / Martensitic Annealed	200	15	◎	◎	◎	
	13		Martensitic Quenched & Tempered	240	23	◎	◎	◎	
	14		Austenitic	180	10	◎	◎	◎	
K	15	Grey cast iron	Pearlitic / ferritic	180	10	◎	◎	◎	
	16		Pearlitic (Martensitic)	260	26	◎	◎	◎	
	17	Nodular cast iron	Ferritic	160	3	◎	◎	◎	
	18		Pearlitic	250	25	◎	◎	◎	
	19	Malleable cast iron	Ferritic	130		◎	◎	◎	
	20		Pearlitic	230	21	◎	◎	◎	
N	21	Aluminum-wrought alloy	Not Curable	60					
	22		Curable Hardened	100					
	23	Aluminum-cast, alloyed	≤ 12% Si, Not Curable	75					
	24		≤ 12% Si, Curable Hardened	90					
	25		> 12% Si, Not Curable	130					
	26	Copper and Copper Alloys (Bronze / Brass)	Cutting Alloys, PB>1%	110					
	27		CuZn, CuSnZn (Brass)	90					
	28	Non Metallic Materials	CuSn, lead-free copper and electrolytic copper	100					
	29		Duroplastic, Fiber Reinforced Plastic						
	30		Rubber, Wood, etc.						
S	31	Heat Resistant Super Alloys	Fe Based Annealed	200	15	○	○	○	
	32		Fe Based Cured	280	30	○	○	○	
	33		Ni or Co Based Annealed	250	25	○	○	○	
	34		Ni or Co Based Cured	350	38	○	○	○	
	35	Titanium Alloys Cast	320	34	○	○	○		
	36	Titanium Alloys	Pure Titanium	400 Rm		○	○	○	
	37		Alpha + Beta Alloys Hardened	1050 Rm		○	○	○	
H	38	Hardened steel	Hardened	550	55				
	39		Hardened	630	60				
	40	Chilled Cast Iron	Cast	400	42				
	41	Hardened Cast Iron	Hardened	550	55				

GMF62 GMF63	GMF52 GMF53	GMF56 GMF57	GMF60 GMF61	GMG16 GMG17	GMG18 GMG19	GMG12 GMG13	GMG14 GMG15	EMB72 EMB73
4	4	4	4	6	6	6	6	5
35°/37° (MULTIPLE HELIX)	35°/37° (MULTIPLE HELIX)	35°/37° (MULTIPLE HELIX)	35°/37° (MULTIPLE HELIX)	45°	45°	45°	45°	41°~45°
CORNER RADIUS	SQUARE	SQUARE	SQUARE	CORNER RADIUS	CORNER RADIUS	SQUARE	SQUARE	SQUARE
D3.0	D3.0	D3.0	D3.0	D6.0	D6.0	D6.0	D6.0	D6.0
D20.0	D20.0	D25.0	D20.0	D25.0	D25.0	D25.0	D25.0	D25.0
445	448	449	450	452	453	455	456	457
LONG LENGTH with NECK	SHORT LENGTH	LONG LENGTH	LONG LENGTH with NECK	LONG LENGTH	EXTRA LONG LENGTH	LONG LENGTH	EXTRA LONG LENGTH	LONG LENGTH
Y-Coating	Y-Coating	Y-Coating	Y-Coating	Y-Coating	Y-Coating	Y-Coating	Y-Coating	AlTiN

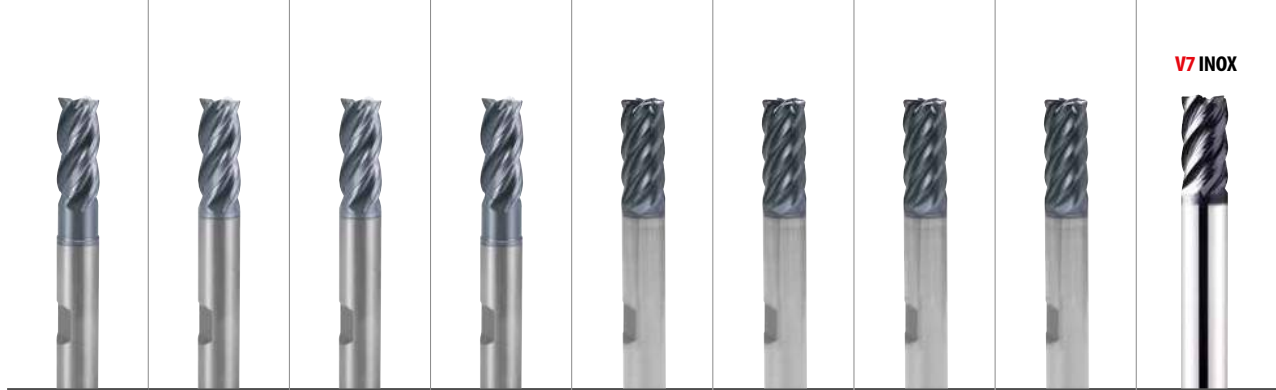

⊙	⊙	⊙	⊙	⊙	⊙	⊙	⊙	⊙	1
⊙	⊙	⊙	⊙	⊙	⊙	⊙	⊙	⊙	2
⊙	⊙	⊙	⊙	⊙	⊙	⊙	⊙	⊙	3
⊙	⊙	⊙	⊙	⊙	⊙	⊙	⊙	⊙	4
⊙	⊙	⊙	⊙	⊙	⊙	⊙	⊙	⊙	5
⊙	⊙	⊙	⊙	⊙	⊙	⊙	⊙	⊙	6 P
⊙	⊙	⊙	⊙	⊙	⊙	⊙	⊙	⊙	7
⊙	⊙	⊙	⊙	⊙	⊙	⊙	⊙	⊙	8
⊙	⊙	⊙	⊙	⊙	⊙	⊙	⊙	⊙	9
⊙	⊙	⊙	⊙	⊙	⊙	⊙	⊙	⊙	10
⊙	⊙	⊙	⊙	⊙	⊙	⊙	⊙	⊙	11
⊙	⊙	⊙	⊙	⊙	⊙	⊙	⊙	⊙	12
⊙	⊙	⊙	⊙	⊙	⊙	⊙	⊙	⊙	13 M
⊙	⊙	⊙	⊙	⊙	⊙	⊙	⊙	⊙	14
⊙	⊙	⊙	⊙	⊙	⊙	⊙	⊙	⊙	15
⊙	⊙	⊙	⊙	⊙	⊙	⊙	⊙	⊙	16
⊙	⊙	⊙	⊙	⊙	⊙	⊙	⊙	⊙	17 K
⊙	⊙	⊙	⊙	⊙	⊙	⊙	⊙	⊙	18
⊙	⊙	⊙	⊙	⊙	⊙	⊙	⊙	⊙	19
⊙	⊙	⊙	⊙	⊙	⊙	⊙	⊙	⊙	20
									21
									22
									23
									24
									25 N
									26
									27
									28
									29
									30
○	○	○	○	○	○	○	○	○	31
○	○	○	○	○	○	○	○	○	32
○	○	○	○	○	○	○	○	○	33
○	○	○	○	○	○	○	○	○	34 S
○	○	○	○	○	○	○	○	○	35
○	○	○	○	○	○	○	○	⊙	36
○	○	○	○	○	○	○	○	⊙	37
									38
									39 H
									40
									41

HSS

CBN
END MILLS

i-Xmill
END MILLS

i-SMART
MODULAR
END MILLS

X5070
END MILLS

4G MILL
END MILLS

X-POWER
PRO
END MILLS

TitaNox-
POWER
END MILLS

JET-POWER
END MILLS

V7 PLUS
END MILLS

ALU-POWER
HPC
END MILLS

ALU-
POWER
END MILLS

D-POWER
GRAPHITE
END MILLS

D-POWER
CFRP
END MILLS

ROUTERS

CRX S
END MILLS

K-2
END MILLS

ONLY ONE
COATED PM60
END MILLS

TANK-
POWER
END MILLS

GENERAL
HSS
END MILLS

MILLING
CUTTERS

TECHNICAL
DATA



PLAIN SHANK

GMG55 SERIES

FLAT SHANK

GMG56 SERIES

CARBIDE, 4 FLUTE BALL NOSE

- **VOLLHARTMETALL, 4 SCHNEIDEN STIRNRADIUS**
- **CARBURE, 4 DENTS, HÉMISPHERIQUE**
- **MD, 4 TAGLIENTI SEMISFERICA**

▶Special flute geometry and multiple helix eliminate vibrations
 ▶Excellent performance for Stainless Steels, Mild Steels, Cast Iron, Low/Medium hardness materials under HRC40

▶Die spezielle Schneidengeometrie und der ungleiche Drill verhindern Vibrationen
 ▶Exzellente Leistung in Edelmetallen, Baustählen, Guss und Stählen unter 40HRc

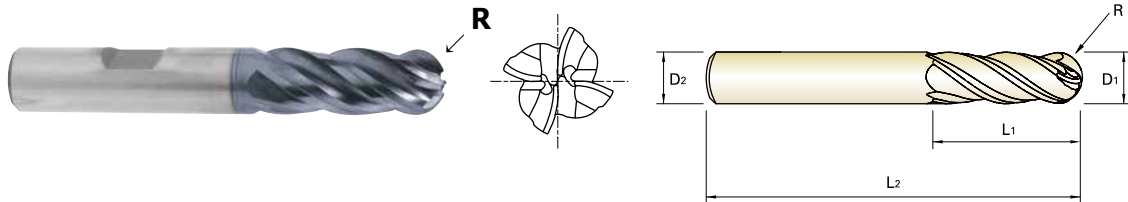

CARBIDE 4 35°/37° ±0.02 PLAIN FLAT P.458

Unit : mm

EDP No.		Radius of Ball Nose	Mill Diameter	Shank Diameter	Length of Cut	Overall Length
PLAIN	FLAT	R	D1	D2	L1	L2
GMG55030	GMG56030	R1.5	3.0	6	8	57
GMG55040	GMG56040	R2.0	4.0	6	11	57
GMG55050	GMG56050	R2.5	5.0	6	13	57
GMG55060	GMG56060	R3.0	6.0	6	13	57
GMG55080	GMG56080	R4.0	8.0	8	19	63
GMG55100	GMG56100	R5.0	10.0	10	22	72
GMG55120	GMG56120	R6.0	12.0	12	26	83
GMG55160	GMG56160	R8.0	16.0	16	32	92
GMG55200	GMG56200	R10.0	20.0	20	38	104
GMG55250	GMG56250	R12.5	25.0	25	38	104

Mill Dia. Tolerance (mm)		Shank Dia. Tolerance
Up to Ø12	0 ~ - 0.02	h5
Over Ø12	0 ~ - 0.03	* Shank Dia. ≥ Ø12 : h6

◎ : Excellent ○ : Good

ISO Material Description	P											M			K					
	Non-alloy steel					Low alloy steel				High alloyed steel, and tool steel		Stainless steel			Grey cast iron		Nodular cast iron		Malleable cast iron	
VDI 3323	1	2	3	4	5	6	7	8	9	10	11	12	13	14	15	16	17	18	19	20
HRc		13	25	28	32	10	29	32	38	15	35	15	23	10	10	26	3	25		21
HB	125	190	250	270	300	180	275	300	350	200	325	200	240	180	180	260	160	250	130	230
Recommend	◎	◎	◎	◎	◎	◎	◎	◎	◎	◎	◎	◎	◎	◎	◎	◎	◎	◎	◎	◎

ISO Material Description	N									S							H				
	Aluminum-wrought alloy		Aluminum-cast, alloyed			Copper and Copper Alloys (Bronze / Brass)		Non Metallic Materials				Heat Resistant Super Alloys			Titanium Alloys		Hardened steel	Chilled Cast Iron	Hardened Cast Iron		
VDI 3323	21	22	23	24	25	26	27	28	29	30	31	32	33	34	35	36	37	38	39	40	41
HRc											15	30	25	38	34			55	60	42	55
HB	60	100	75	90	130	110	90	100			200	280	250	350	320	400 Rm	1050 Rm	550	630	400	550
Recommend											○	○	○	○	○	○	○				



CARBIDE, 4 FLUTE CORNER RADIUS SHORT LENGTH

- VOLLHARTMETALL, 4 SCHNEIDEN ECKENRADIUS KURZ
- CARBURE, 4 DENTS, SÉRIE COURTE, RAYONNÉE
- MD, 4 TAGLIENTI SERIE CORTA TORICA

▶ Special flute geometry and multiple helix eliminate vibrations
 ▶ Excellent performance for Stainless Steels, Mild Steels, Cast Iron, Low/Medium hardness materials under HRC40

▶ Die spezielle Schneidengeometrie und der ungleiche Drill verhindern Vibrationen
 ▶ Exzellente Leistung in Edelstählen, Baustählen, Guss und Stählen unter 40HRC

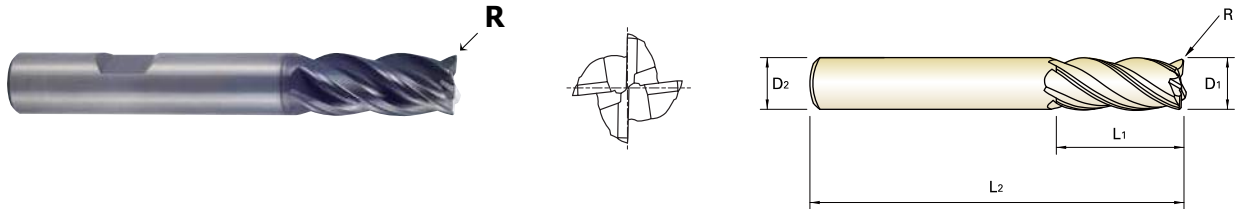

EDP No.		Corner Radius	Mill Diameter	Shank Diameter	Length of Cut	Overall Length
PLAIN	FLAT	R	D1	D2	L1	L2
GMF54030	GMF55030	R0.3	3.0	6	7	54
GMF54901	GMF55901	R0.5	3.0	6	7	54
GMF54040	GMF55040	R0.3	4.0	6	8	54
GMF54902	GMF55902	R0.5	4.0	6	8	54
GMF54050	GMF55050	R0.3	5.0	6	10	54
GMF54903	GMF55903	R0.5	5.0	6	10	54
GMF54060	GMF55060	R0.3	6.0	6	10	54
GMF54904	GMF55904	R0.5	6.0	6	10	54
GMF54905	GMF55905	R1.0	6.0	6	10	54
GMF54080	GMF55080	R0.5	8.0	8	12	58
GMF54906	GMF55906	R1.0	8.0	8	12	58
GMF54100	GMF55100	R0.5	10.0	10	14	66
GMF54907	GMF55907	R1.0	10.0	10	14	66
GMF54120	GMF55120	R0.5	12.0	12	16	73
GMF54908	GMF55908	R1.0	12.0	12	16	73
GMF54909	GMF55909	R2.0	12.0	12	16	73
GMF54140	GMF55140	R0.5	14.0	14	18	75
GMF54160	GMF55160	R1.0	16.0	16	22	82
GMF54912	GMF55912	R2.0	16.0	16	22	82
GMF54913	GMF55913	R3.0	16.0	16	22	82
GMF54180	GMF55180	R1.0	18.0	18	24	84
GMF54200	GMF55200	R1.0	20.0	20	26	92
GMF54916	GMF55916	R2.0	20.0	20	26	92
GMF54917	GMF55917	R3.0	20.0	20	26	92

Mill Dia. Tolerance (mm)		Shank Dia. Tolerance
Up to Ø12	0 ~ - 0.02	h5
Over Ø12	0 ~ - 0.03	* Shank Dia. ≥ Ø12 : h6

ISO Material Description	P										M				K						
	Non-alloy steel					Low alloy steel					High alloyed steel, and tool steel				Stainless steel		Grey cast iron		Nodular cast iron		Malleable cast iron
VDI 3323	1	2	3	4	5	6	7	8	9	10	11	12	13	14	15	16	17	18	19	20	
HRC		13	25	28	32	10	29	32	38	15	35	15	23	10	10	26	3	25	130	21	
HB	125	190	250	270	300	180	275	300	350	200	325	200	240	180	180	260	160	250	130	230	
Recommend	○	○	○	○	○	○	○	○	○	○	○	○	○	○	○	○	○	○	○	○	

ISO Material Description	N					S										H					
	Aluminum-wrought alloy		Aluminum-cast, alloyed		Copper and Copper Alloys (Bronze / Brass)	Non Metallic Materials	Heat Resistant Super Alloys					Titanium Alloys		Hardened steel	Chilled Cast Iron	Hardened Cast Iron					
VDI 3323	21	22	23	24	25	26	27	28	29	30	31	32	33	34	35	36	37	38	39	40	41
HRC											15	30	25	38	34			55	60	42	55
HB	60	100	75	90	130	110	90	100			200	280	250	350	320	400 Rm	1050 Rm	550	630	400	550
Recommend											○	○	○	○	○	○	○				



PLAIN SHANK

GMF58 SERIES

FLAT SHANK

GMF59 SERIES

CARBIDE, 4 FLUTE CORNER RADIUS LONG LENGTH

- VOLLHARTMETALL, 4 SCHNEIDEN ECKENRADIUS LANG
- CARBURE, 4 DENTS, SÉRIE LONGUE, RAYONNÉE
- MD, 4 TAGLIENTI SERIE LUNGA TORICA

- ▶ Special flute geometry and multiple helix eliminate vibrations
- ▶ Excellent performance for Stainless Steels, Mild Steels, Cast Iron, Low/Medium hardness materials under HRC40

- ▶ Die spezielle Schneidengeometrie und der ungleiche Drill verhindern Vibrationen
- ▶ Exzellente Leistung in Edelmetallen, Baustählen, Guss und Stählen unter 40HRC

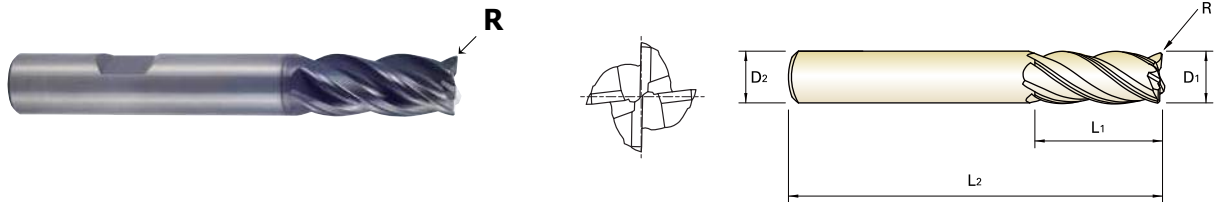

P.459

Unit : mm

EDP No.	Corner Radius		Mill Diameter	Shank Diameter	Length of Cut	Overall Length
	PLAIN	FLAT	R	D1	D2	L1
GMF58030	GMF59030	R0.3	3.0	6	8	57
GMF58901	GMF59901	R0.5	3.0	6	8	57
GMF58040	GMF59040	R0.3	4.0	6	11	57
GMF58902	GMF59902	R0.5	4.0	6	11	57
GMF58050	GMF59050	R0.3	5.0	6	13	57
GMF58903	GMF59903	R0.5	5.0	6	13	57
GMF58060	GMF59060	R0.3	6.0	6	13	57
GMF58904	GMF59904	R0.5	6.0	6	13	57
GMF58905	GMF59905	R1.0	6.0	6	13	57
GMF58080	GMF59080	R0.5	8.0	8	19	63
GMF58906	GMF59906	R1.0	8.0	8	19	63
GMF58100	GMF59100	R0.5	10.0	10	22	72
GMF58907	GMF59907	R1.0	10.0	10	22	72
GMF58120	GMF59120	R0.5	12.0	12	26	83
GMF58908	GMF59908	R1.0	12.0	12	26	83
GMF58909	GMF59909	R2.0	12.0	12	26	83
GMF58140	GMF59140	R0.5	14.0	14	26	83
GMF58160	GMF59160	R1.0	16.0	16	32	92
GMF58912	GMF59912	R2.0	16.0	16	32	92
GMF58913	GMF59913	R3.0	16.0	16	32	92
GMF58180	GMF59180	R1.0	18.0	18	32	92
GMF58200	GMF59200	R1.0	20.0	20	38	104
GMF58916	GMF59916	R2.0	20.0	20	38	104
GMF58917	GMF59917	R3.0	20.0	20	38	104
GMF58250	GMF59250	R1.0	25.0	25	38	104

Mill Dia. Tolerance (mm)	Shank Dia. Tolerance
Up to Ø12	0 ~ - 0.02
Over Ø12	0 ~ - 0.03
	h5
	* Shank Dia. ≥ Ø12 : h6

◎ : Excellent ○ : Good

ISO Material Description	P											M				K					
	Non-alloy steel					Low alloy steel				High alloyed steel, and tool steel		Stainless steel				Grey cast iron		Nodular cast iron		Malleable cast iron	
VDI 3323	1	2	3	4	5	6	7	8	9	10	11	12	13	14	15	16	17	18	19	20	
HRC		13	25	28	32	10	29	32	38	15	35	15	23	10	10	26	3	25		21	
HB	125	190	250	270	300	180	275	300	350	200	325	200	240	180	180	260	160	250	130	230	
Recommend	◎	◎	◎	◎	◎	◎	◎	◎	◎	◎	◎	◎	◎	◎	◎	◎	◎	◎	◎	◎	
ISO Material Description	N										S							H			
	Aluminum-wrought alloy		Aluminum-cast, alloyed			Copper and Copper Alloys (Bronze / Brass)			Non Metallic Materials		Heat Resistant Super Alloys					Titanium Alloys		Hardened steel	Chilled Cast Iron	Hardened Cast Iron	
VDI 3323	21	22	23	24	25	26	27	28	29	30	31	32	33	34	35	36	37	38	39	40	41
HRC											15	30	25	38	34			55	60	42	55
HB	60	100	75	90	130	110	90	100			200	280	250	350	320	400 Rm	1050 Rm	550	630	400	550
Recommend											○	○	○	○	○	○	○				

CARBIDE, 4 FLUTE CORNER RADIUS with EXTENDED NECK
 ● VOLLHARTMETALL, 4 SCHNEIDEN ECKENRADIUS mit ABGESETZTEM HALS
 ○ CARBURE, 4 DENTS, DÉTALONNÉE, RAYONNÉE
 ○ MD, 4 TAGLIENTI CON SCARICO ESTESO TORICA

- ▶ Special flute geometry and multiple helix eliminate vibrations
- ▶ Excellent performance for Stainless Steels, Mild Steels, Cast Iron, Low/Medium hardness materials under HRC40
- ▶ Die spezielle Schneidengeometrie und der ungleiche Drill verhindern Vibrationen
- ▶ Exzellente Leistung in Edeltählen, Baustählen, Guss und Stählen unter 40HRC

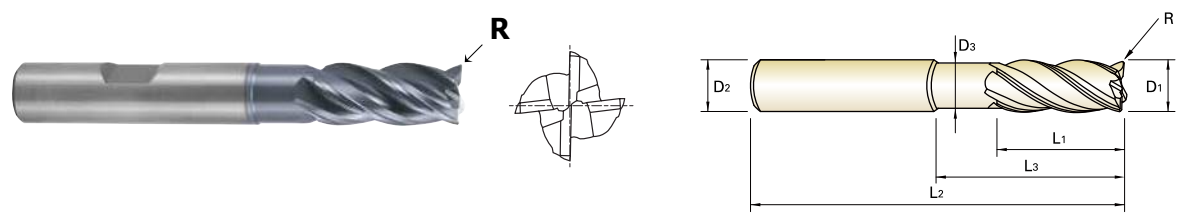

CARBIDE 4 35°/37° PLAIN FLAT P.459

EDP No.		Corner Radius	Mill Diameter	Shank Diameter	Length of Cut	Length Below Shank	Overall Length	Neck Diameter
PLAIN	FLAT	R	D1	D2	L1	L3	L2	D3
GMF62030	GMF63030	R0.3	3.0	6	7	12	54	2.7
GMF62901	GMF63901	R0.5	3.0	6	7	12	54	2.7
GMF62902	GMF63902	R0.3	3.0	6	7	17	57	2.7
GMF62903	GMF63903	R0.5	3.0	6	7	17	57	2.7
GMF62040	GMF63040	R0.3	4.0	6	8	15	57	3.7
GMF62904	GMF63904	R0.5	4.0	6	8	15	57	3.7
GMF62905	GMF63905	R0.3	4.0	6	8	22	63	3.7
GMF62906	GMF63906	R0.5	4.0	6	8	22	63	3.7
GMF62050	GMF63050	R0.3	5.0	6	10	17	57	4.7
GMF62907	GMF63907	R0.5	5.0	6	10	17	57	4.7
GMF62908	GMF63908	R0.3	5.0	6	10	27	67	4.7
GMF62909	GMF63909	R0.5	5.0	6	10	27	67	4.7
GMF62060	GMF63060	R0.3	6.0	6	10	15	57	5.5
GMF62910	GMF63910	R0.5	6.0	6	10	15	57	5.5
GMF62911	GMF63911	R1.0	6.0	6	10	15	57	5.5
GMF62912	GMF63912	R0.3	6.0	6	10	20	62	5.5
GMF62913	GMF63913	R0.5	6.0	6	10	20	62	5.5
GMF62914	GMF63914	R1.0	6.0	6	10	20	62	5.5
GMF62915	GMF63915	R0.3	6.0	6	10	32	74	5.5
GMF62916	GMF63916	R0.5	6.0	6	10	32	74	5.5
GMF62917	GMF63917	R1.0	6.0	6	10	32	74	5.5
GMF62080	GMF63080	R0.5	8.0	8	12	20	63	7.5
GMF62918	GMF63918	R1.0	8.0	8	12	20	63	7.5
GMF62919	GMF63919	R0.5	8.0	8	12	30	73	7.5

Unit : mm

Mill Dia. Tolerance (mm)	Shank Dia. Tolerance
Up to Ø12	0 ~ - 0.02
Over Ø12	0 ~ - 0.03

h5
* Shank Dia. ≥ Ø12 : h6

▶ NEXT PAGE

◎ : Excellent ○ : Good

ISO Material Description	P											M				K							
	Non-alloy steel					Low alloy steel						High alloyed steel, and tool steel				Stainless steel				Grey cast iron		Nodular cast iron	
VDI 3323	1	2	3	4	5	6	7	8	9	10	11	12	13	14	15	16	17	18	19	20			
HRC	13	25	28	32	10	29	32	38	15	35	15	23	10	10	26	3	25	42	55				
HB	125	190	250	270	300	180	275	300	350	200	325	200	240	180	180	260	160	130	230				
Recommend	◎	◎	◎	◎	◎	◎	◎	◎	◎	◎	◎	◎	◎	◎	◎	◎	◎	◎	◎	◎			

ISO Material Description	N										S						H				
	Aluminum-wrought alloy		Aluminum-cast, alloyed			Copper and Copper Alloys (Bronze / Brass)			Non Metallic Materials		Heat Resistant Super Alloys						Titanium Alloys		Hardened steel	Chilled Cast Iron	Hardened Cast Iron
VDI 3323	21	22	23	24	25	26	27	28	29	30	31	32	33	34	35	36	37	38	39	40	41
HRC	15	30	25	38	34	200	280	250	350	320	400 Rm	1050 Rm	550	630	400	550	42	55			
HB	60	100	75	90	130	110	90	100										400	550		
Recommend	◎	◎	◎	◎	◎	◎	◎	◎	◎	◎	◎	◎	◎	◎	◎	◎	◎	◎	◎		



PLAIN SHANK

GMF62 SERIES

FLAT SHANK

GMF63 SERIES

CARBIDE, 4 FLUTE CORNER RADIUS with EXTENDED NECK

- **VOLLHARTMETALL, 4 SCHNEIDEN ECKENRADIUS mit ABGESETZTEM HALS**
- **CARBURE, 4 DENTS, DÉTALONNÉE, RAYONNÉE**
- **MD, 4 TAGLIENTI CON SCARICO ESTESO TORICA**

▶Special flute geometry and multiple helix eliminate vibrations
 ▶Excellent performance for Stainless Steels, Mild Steels, Cast Iron, Low/Medium hardness materials under HRC40

▶Die spezielle Schneidengeometrie und der ungleiche Drill verhindern Vibrationen
 ▶Exzellente Leistung in Edelmetallen, Baustählen, Guss und Stählen unter 40HRc

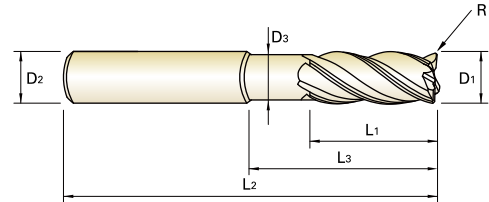

Unit : mm

EDP No.		Corner Radius	Mill Diameter	Shank Diameter	Length of Cut	Length Below Shank	Overall Length	Neck Diameter
PLAIN	FLAT	R	D1	D2	L1	L3	L2	D3
GMF62920	GMF63920	R1.0	8.0	8	12	30	73	7.5
GMF62921	GMF63921	R0.5	8.0	8	12	46	90	7.5
GMF62922	GMF63922	R1.0	8.0	8	12	46	90	7.5
GMF62100	GMF63100	R0.5	10.0	10	14	25	72	9.2
GMF62923	GMF63923	R1.0	10.0	10	14	25	72	9.2
GMF62924	GMF63924	R0.5	10.0	10	14	35	82	9.2
GMF62925	GMF63925	R1.0	10.0	10	14	35	82	9.2
GMF62926	GMF63926	R0.5	10.0	10	14	55	102	9.2
GMF62927	GMF63927	R1.0	10.0	10	14	55	102	9.2
GMF62120	GMF63120	R0.5	12.0	12	16	30	83	11.0
GMF62928	GMF63928	R1.0	12.0	12	16	30	83	11.0
GMF62929	GMF63929	R2.0	12.0	12	16	30	83	11.0
GMF62930	GMF63930	R0.5	12.0	12	16	40	93	11.0
GMF62931	GMF63931	R1.0	12.0	12	16	40	93	11.0
GMF62932	GMF63932	R2.0	12.0	12	16	40	93	11.0
GMF62933	GMF63933	R0.5	12.0	12	16	64	117	11.0
GMF62934	GMF63934	R1.0	12.0	12	16	64	117	11.0
GMF62935	GMF63935	R2.0	12.0	12	16	64	117	11.0
GMF62160	GMF63160	R1.0	16.0	16	22	38	92	15.0
GMF62936	GMF63936	R2.0	16.0	16	22	38	92	15.0
GMF62937	GMF63937	R3.0	16.0	16	22	38	92	15.0
GMF62938	GMF63938	R1.0	16.0	16	22	55	109	15.0
GMF62939	GMF63939	R2.0	16.0	16	22	55	109	15.0
GMF62940	GMF63940	R3.0	16.0	16	22	55	109	15.0

Mill Dia. Tolerance (mm)	Shank Dia. Tolerance
Up to Ø12	0 ~ - 0.02
Over Ø12	0 ~ - 0.03

h5
* Shank Dia. ≥ Ø12 : h6

▶ NEXT PAGE

◎ : Excellent ○ : Good

ISO Material Description	P											M				K				
	Non-alloy steel					Low alloy steel				High alloyed steel, and tool steel		Stainless steel				Grey cast iron		Nodular cast iron		Malleable cast iron
VDI 3323	1	2	3	4	5	6	7	8	9	10	11	12	13	14	15	16	17	18	19	20
HRc		13	25	28	32	10	29	32	38	15	35	15	23	10	10	26	3	25		21
HB	125	190	250	270	300	180	275	300	350	200	325	200	240	180	180	260	160	250	130	230
Recommend	◎	◎	◎	◎	◎	◎	◎	◎	◎	◎	◎	◎	◎	◎	◎	◎	◎	◎	◎	◎

ISO Material Description	N										S							H			
	Aluminum-wrought alloy		Aluminum-cast, alloyed			Copper and Copper Alloys (Bronze / Brass)			Non Metallic Materials		Heat Resistant Super Alloys					Titanium Alloys		Hardened steel	Chilled Cast Iron	Hardened Cast Iron	
VDI 3323	21	22	23	24	25	26	27	28	29	30	31	32	33	34	35	36	37	38	39	40	41
HRc											15	30	25	38	34			55	60	42	55
HB	60	100	75	90	130	110	90	100			200	280	250	350	320	400 Rm	1050 Rm	550	630	400	550
Recommend											○	○	○	○	○	○	○				

CARBIDE, 4 FLUTE CORNER RADIUS with EXTENDED NECK

- VOLLHARTMETALL, 4 SCHNEIDEN ECKENRADIUS mit ABGESETZTEM HALS
- CARBURE, 4 DENTS, DÉTALONNÉE, RAYONNÉE
- MD, 4 TAGLIENTI CON SCARICO ESTESO TORICA

▶ Special flute geometry and multiple helix eliminate vibrations
 ▶ Excellent performance for Stainless Steels, Mild Steels, Cast Iron,
 Low/Medium hardness materials under HRC40

▶ Die spezielle Schneidengeometrie und der ungleiche Drall verhindern Vibrationen
 ▶ Exzellente Leistung in Edelstählen, Baustählen, Guss und Stählen unter 40HRC

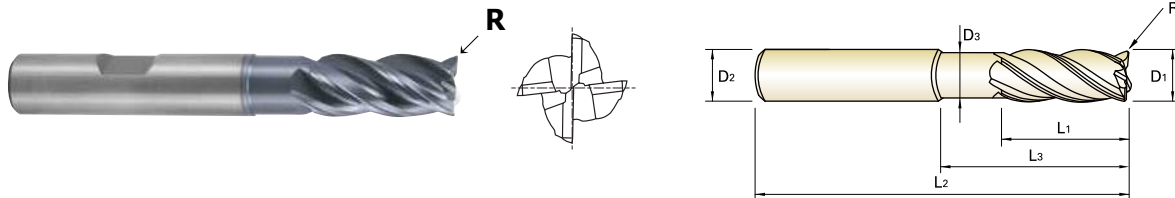

Unit : mm

EDP No.		Corner Radius	Mill Diameter	Shank Diameter	Length of Cut	Length Below Shank	Overall Length	Neck Diameter
PLAIN	FLAT	R	D1	D2	L1	L3	L2	D3
GMF62941	GMF63941	R1.0	16.0	16	22	87	141	15.0
GMF62942	GMF63942	R2.0	16.0	16	22	87	141	15.0
GMF62943	GMF63943	R3.0	16.0	16	22	87	141	15.0
GMF62200	GMF63200	R1.0	20.0	20	26	50	104	19.0
GMF62944	GMF63944	R2.0	20.0	20	26	50	104	19.0
GMF62945	GMF63945	R3.0	20.0	20	26	50	104	19.0
GMF62946	GMF63946	R1.0	20.0	20	26	70	124	19.0
GMF62947	GMF63947	R2.0	20.0	20	26	70	124	19.0
GMF62948	GMF63948	R3.0	20.0	20	26	70	124	19.0
GMF62949	GMF63949	R1.0	20.0	20	26	110	164	19.0
GMF62950	GMF63950	R2.0	20.0	20	26	110	164	19.0
GMF62951	GMF63951	R3.0	20.0	20	26	110	164	19.0

Mill Dia. Tolerance (mm)		Shank Dia. Tolerance
Up to Ø12	0 ~ - 0.02	h5
Over Ø12	0 ~ - 0.03	* Shank Dia. ≥ Ø12 : h6

◎ : Excellent ○ : Good

ISO Material Description	P										M				K						
	Non-alloy steel					Low alloy steel					High alloyed steel, and tool steel				Stainless steel		Grey cast iron		Nodular cast iron		Malleable cast iron
VDI 3323	1	2	3	4	5	6	7	8	9	10	11	12	13	14	15	16	17	18	19	20	
HRC	125	130	190	250	270	180	275	300	350	200	325	200	240	180	180	260	160	250	130	230	
Recommend	◎	◎	◎	◎	◎	◎	◎	◎	◎	◎	◎	◎	◎	◎	◎	◎	◎	◎	◎	◎	

ISO Material Description	N					S										H					
	Aluminum-wrought alloy		Aluminum-cast, alloyed			Copper and Copper Alloys (Bronze / Brass)			Non Metallic Materials		Heat Resistant Super Alloys					Titanium Alloys		Hardened steel	Chilled Cast Iron	Hardened Cast Iron	
VDI 3323	21	22	23	24	25	26	27	28	29	30	31	32	33	34	35	36	37	38	39	40	41
HRC	60	100	75	90	130	110	90	100			200	280	250	350	320	400 Rm	1050 Rm	550	630	400	550
Recommend											○	○	○	○	○	○	○				



PLAIN SHANK

GMF52 SERIES

FLAT SHANK

GMF53 SERIES

CARBIDE, 4 FLUTE SHORT LENGTH

- **VOLLHARTMETALL, 4 SCHNEIDEN KURZ**
- **CARBURE, 4 DENTS, SÉRIE COURTE**
- **MD, 4 TAGLIANTI SERIE CORTA**

▶Special flute geometry and multiple helix eliminate vibrations
 ▶Excellent performance for Stainless Steels, Mild Steels, Cast Iron, Low/Medium hardness materials under HRC40

▶Die spezielle Schneidengeometrie und der ungleiche Drill verhindern Vibrationen
 ▶Exzellente Leistung in Edelstählen, Baustählen, Guss und Stählen unter 40HRC

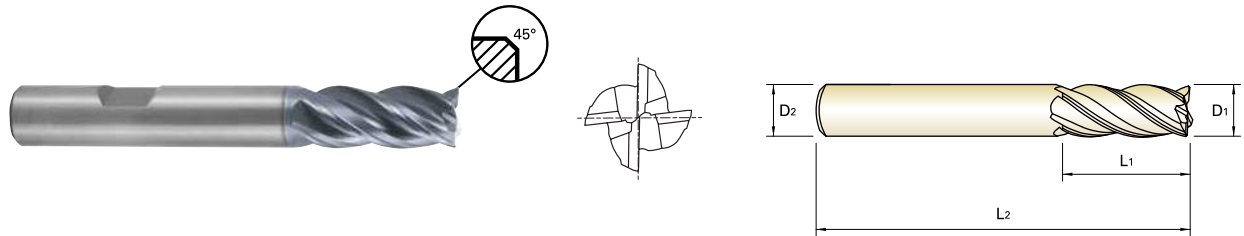

Unit : mm

EDP No.		Mill Diameter	Shank Diameter	Length of Cut	Overall Length	Chamfer
PLAIN	FLAT	D1	D2	L1	L2	
GMF52030	GMF53030	3.0	6	7	54	0.10
GMF52040	GMF53040	4.0	6	8	54	0.15
GMF52050	GMF53050	5.0	6	10	54	0.15
GMF52060	GMF53060	6.0	6	10	54	0.20
GMF52080	GMF53080	8.0	8	12	58	0.20
GMF52100	GMF53100	10.0	10	14	66	0.30
GMF52120	GMF53120	12.0	12	16	73	0.35
GMF52140	GMF53140	14.0	14	18	75	0.40
GMF52160	GMF53160	16.0	16	22	82	0.40
GMF52180	GMF53180	18.0	18	24	84	0.50
GMF52200	GMF53200	20.0	20	26	92	0.50

Mill Dia. Tolerance (mm)		Shank Dia. Tolerance
Up to Ø12	0 ~ - 0.02	h5
Over Ø12	0 ~ - 0.03	* Shank Dia. ≥ Ø12 : h6

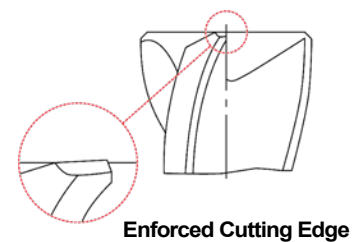

◎ : Excellent ○ : Good

ISO Material Description	P											M			K						
	Non-alloy steel					Low alloy steel				High alloyed steel, and tool steel		Stainless steel			Grey cast iron		Nodular cast iron		Malleable cast iron		
VDI 3323	1	2	3	4	5	6	7	8	9	10	11	12	13	14	15	16	17	18	19	20	
HRc		13	25	28	32	10	29	32	38	15	35	15	23	10	10	26	3	25		21	
HB	125	190	250	270	300	180	275	300	350	200	325	200	240	180	180	260	160	250	130	230	
Recommend	◎	◎	◎	◎	◎	◎	◎	◎	◎	◎	◎	◎	◎	◎	◎	◎	◎	◎	◎	◎	
ISO Material Description	N									S						H					
	Aluminum-wrought alloy		Aluminum-cast, alloyed			Copper and Copper Alloys (Bronze / Brass)		Non Metallic Materials		Heat Resistant Super Alloys						Titanium Alloys		Hardened steel	Chilled Cast Iron	Hardened Cast Iron	
VDI 3323	21	22	23	24	25	26	27	28	29	30	31	32	33	34	35	36	37	38	39	40	41
HRc											15	30	25	38	34			55	60	42	55
HB	60	100	75	90	130	110	90	100			200	280	250	350	320	400 Rm	1050 Rm	550	630	400	550
Recommend											○	○	○	○	○	○	○				

CARBIDE, 4 FLUTE LONG LENGTH

- VOLLHARTMETALL, 4 SCHNEIDEN LANG
- CARBURE, 4 DENTS, SÉRIE LONGUE
- MD, 4 TAGLIENTI SERIE LUNGA

▶ Special flute geometry and multiple helix eliminate vibrations
 ▶ Excellent performance for Stainless Steels, Mild Steels, Cast Iron, Low/Medium hardness materials under HRC40

▶ Die spezielle Schneidengeometrie und der ungleiche Drall verhindern Vibrationen
 ▶ Exzellente Leistung in Edelstählen, Baustählen, Guss und Stählen unter 40HRC

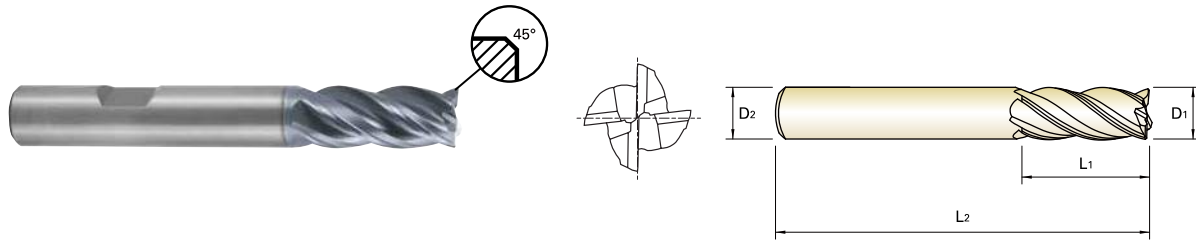

Unit : mm

EDP No.		Mill Diameter	Shank Diameter	Length of Cut	Overall Length	Chamfer
PLAIN	FLAT	D1	D2	L1	L2	
GMF56030	GMF57030	3.0	6	8	57	0.10
GMF56040	GMF57040	4.0	6	11	57	0.15
GMF56050	GMF57050	5.0	6	13	57	0.15
GMF56060	GMF57060	6.0	6	13	57	0.20
GMF56080	GMF57080	8.0	8	19	63	0.20
GMF56100	GMF57100	10.0	10	22	72	0.30
GMF56120	GMF57120	12.0	12	26	83	0.35
GMF56140	GMF57140	14.0	14	26	83	0.40
GMF56160	GMF57160	16.0	16	32	92	0.40
GMF56180	GMF57180	18.0	18	32	92	0.50
GMF56200	GMF57200	20.0	20	38	104	0.50
GMF56250	GMF57250	25.0	25	38	104	0.50

Mill Dia. Tolerance (mm)		Shank Dia. Tolerance
Up to Ø12	0 ~ - 0.02	h5
Over Ø12	0 ~ - 0.03	* Shank Dia. ≥ Ø12 : h6

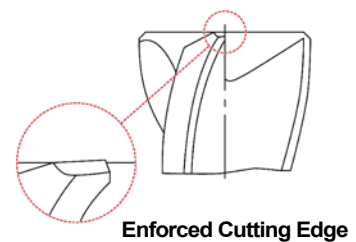

◎ : Excellent ○ : Good

ISO Material Description	P										M				K						
	Non-alloy steel					Low alloy steel					High alloyed steel, and tool steel				Stainless steel		Grey cast iron		Nodular cast iron		Malleable cast iron
VDI 3323	1	2	3	4	5	6	7	8	9	10	11	12	13	14	15	16	17	18	19	20	
HRC		13	25	28	32	10	29	32	38	15	35	15	23	10	10	26	3	25		21	
HB	125	190	250	270	300	180	275	300	350	200	325	200	240	180	180	260	160	250	130	230	
Recommend	◎	◎	◎	◎	◎	◎	◎	◎	◎	◎	◎	◎	◎	◎	◎	◎	◎	◎	◎	◎	
ISO Material Description	N										S						H				
	Aluminum-wrought alloy		Aluminum-cast, alloyed			Copper and Copper Alloys (Bronze / Brass)			Non Metallic Materials		Heat Resistant Super Alloys						Titanium Alloys		Hardened steel	Chilled Cast Iron	Hardened Cast Iron
VDI 3323	21	22	23	24	25	26	27	28	29	30	31	32	33	34	35	36	37	38	39	40	41
HRC											15	30	25	38	34			55	60	42	55
HB	60	100	75	90	130	110	90	100			200	280	250	350	320	400 Rm	1050 Rm	550	630	400	550
Recommend											○	○	○	○	○	○	○	◎	◎	◎	◎



CARBIDE, 4 FLUTE with EXTENDED NECK

- **VOLLHARTMETALL, 4 SCHNEIDEN mit ABGESETZTEM HALS**
- **CARBURE, 4 DENTS, DÉTALONNÉE**
- **MD, 4 TAGLIENTI CON SCARICO ESTESO**

▶Special flute geometry and multiple helix eliminate vibrations
 ▶Excellent performance for Stainless Steels, Mild Steels, Cast Iron, Low/Medium hardness materials under HRC40

▶Die spezielle Schneidengeometrie und der ungleiche Drill verhindern Vibrationen
 ▶Exzellente Leistung in Edelmetallen, Baustählen, Guss und Stählen unter 40HRC

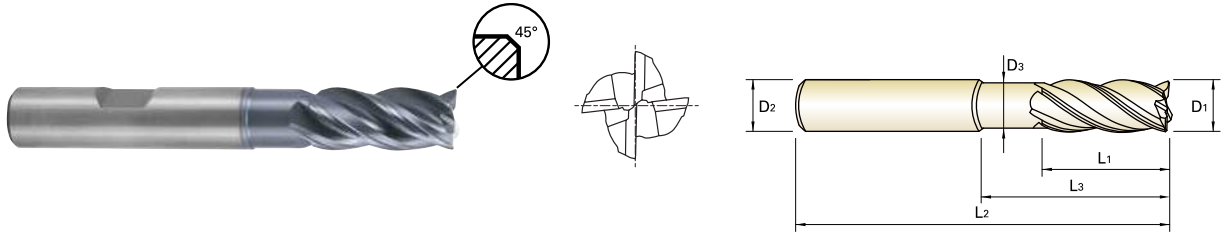

Unit : mm

EDP No.		Mill Diameter	Shank Diameter	Length of Cut	Length Below Shank	Overall Length	Neck Diameter	Chamfer
PLAIN	FLAT	D1	D2	L1	L3	L2	D3	
GMF60030	GMF61030	3.0	6	7	12	54	2.7	0.10
GMF60901	GMF61901	3.0	6	7	17	57	2.7	0.10
GMF60902	GMF61902	3.0	6	8	14	57	2.7	0.10
GMF60040	GMF61040	4.0	6	8	15	57	3.7	0.15
GMF60903	GMF61903	4.0	6	8	22	63	3.7	0.15
GMF60904	GMF61904	4.0	6	11	16	57	3.7	0.15
GMF60050	GMF61050	5.0	6	10	17	57	4.7	0.15
GMF60905	GMF61905	5.0	6	10	27	67	4.7	0.15
GMF60906	GMF61906	5.0	6	13	18	57	4.7	0.15
GMF60060	GMF61060	6.0	6	10	15	57	5.5	0.20
GMF60907	GMF61907	6.0	6	10	20	62	5.5	0.20
GMF60908	GMF61908	6.0	6	10	32	74	5.5	0.20
GMF60909	GMF61909	6.0	6	13	21	57	5.5	0.20
GMF60080	GMF61080	8.0	8	12	20	63	7.5	0.20
GMF60910	GMF61910	8.0	8	12	30	73	7.5	0.20
GMF60911	GMF61911	8.0	8	12	46	90	7.5	0.20
GMF60912	GMF61912	8.0	8	19	27	63	7.5	0.20
GMF60100	GMF61100	10.0	10	14	25	72	9.2	0.30
GMF60913	GMF61913	10.0	10	14	35	82	9.2	0.30
GMF60914	GMF61914	10.0	10	14	55	102	9.2	0.30
GMF60915	GMF61915	10.0	10	22	32	72	9.2	0.30

Mill Dia. Tolerance (mm)		Shank Dia. Tolerance
Up to Ø12	0 ~ - 0.02	h5
Over Ø12	0 ~ - 0.03	* Shank Dia. ≥ Ø12 : h6

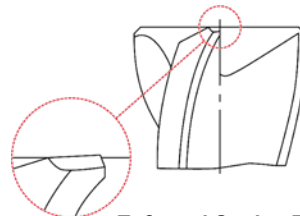

▶ NEXT PAGE

Enforced Cutting Edge

◎ : Excellent ○ : Good

ISO Material Description	P											M				K					
	Non-alloy steel					Low alloy steel				High alloyed steel, and tool steel		Stainless steel		Grey cast iron		Nodular cast iron		Malleable cast iron			
VDI 3323	1	2	3	4	5	6	7	8	9	10	11	12	13	14	15	16	17	18	19	20	
HRc		13	25	28	32	10	29	32	38	15	35	15	23	10	10	26	3	25		21	
HB	125	190	250	270	300	180	275	300	350	200	325	200	240	180	180	260	160	250	130	230	
Recommend	◎	◎	◎	◎	◎	◎	◎	◎	◎	◎	◎	◎	◎	◎	◎	◎	◎	◎	◎	◎	
ISO Material Description	N									S							H				
	Aluminum-wrought alloy		Aluminum-cast, alloyed			Copper and Copper Alloys (Bronze / Brass)		Non Metallic Materials		Heat Resistant Super Alloys					Titanium Alloys		Hardened steel	Chilled Cast Iron	Hardened Cast Iron		
VDI 3323	21	22	23	24	25	26	27	28	29	30	31	32	33	34	35	36	37	38	39	40	41
HRc											15	30	25	38	34			55	60	42	55
HB	60	100	75	90	130	110	90	100			200	280	250	350	320	400 Rm	1050 Rm	550	630	400	550
Recommend											○	○	○	○	○	○	○				

CARBIDE, 4 FLUTE with EXTENDED NECK

- VOLLHARTMETALL, 4 SCHNEIDEN mit ABGESETZTEM HALS
- CARBURE, 4 DENTS, DÉTALONNÉE
- MD, 4 TAGLIENTI CON SCARICO ESTESO

▶ Special flute geometry and multiple helix eliminate vibrations
 ▶ Excellent performance for Stainless Steels, Mild Steels, Cast Iron, Low/Medium hardness materials under HRC40

▶ Die spezielle Schneidengeometrie und der ungleiche Drall verhindern Vibrationen
 ▶ Exzellente Leistung in Edelstählen, Baustählen, Guss und Stählen unter 40HRC

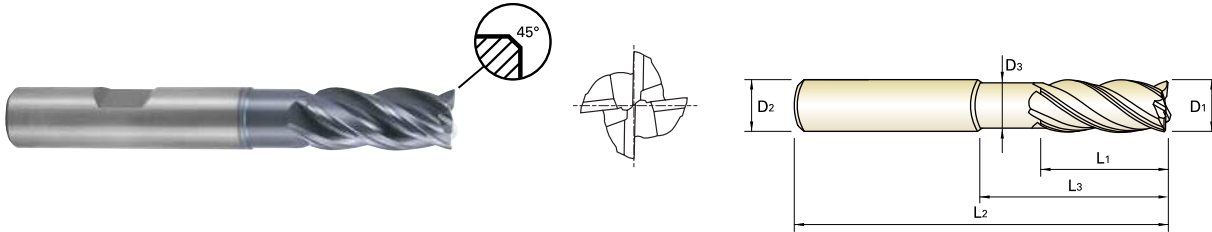

Unit : mm

EDP No.		Mill Diameter	Shank Diameter	Length of Cut	Length Below Shank	Overall Length	Neck Diameter	Chamfer
PLAIN	FLAT	D1	D2	L1	L3	L2	D3	
GMF60120	GMF61120	12.0	12	16	30	83	11.0	0.35
GMF60916	GMF61916	12.0	12	16	40	93	11.0	0.35
GMF60917	GMF61917	12.0	12	16	64	117	11.0	0.35
GMF60918	GMF61918	12.0	12	26	38	83	11.0	0.35
GMF60160	GMF61160	16.0	16	22	38	92	15.0	0.40
GMF60919	GMF61919	16.0	16	22	55	109	15.0	0.40
GMF60920	GMF61920	16.0	16	22	87	141	15.0	0.40
GMF60921	GMF61921	16.0	16	32	44	92	15.0	0.40
GMF60200	GMF61200	20.0	20	26	50	104	19.0	0.50
GMF60922	GMF61922	20.0	20	26	70	124	19.0	0.50
GMF60923	GMF61923	20.0	20	26	110	164	19.0	0.50
GMF60924	GMF61924	20.0	20	38	54	104	19.0	0.50

Mill Dia. Tolerance (mm)		Shank Dia. Tolerance
Up to Ø12	0 ~ - 0.02	h5
Over Ø12	0 ~ - 0.03	* Shank Dia. ≥ Ø12 : h6

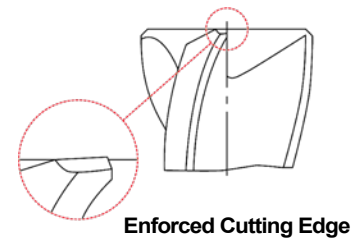

◎ : Excellent ○ : Good

ISO Material Description	P										M				K						
	Non-alloy steel					Low alloy steel					High alloyed steel, and tool steel				Stainless steel		Grey cast iron		Nodular cast iron		Malleable cast iron
VDI 3323	1	2	3	4	5	6	7	8	9	10	11	12	13	14	15	16	17	18	19	20	
HRC	125	13	25	28	32	10	29	32	38	15	35	15	23	10	10	26	3	25	42	21	
HB	125	190	250	270	300	180	275	300	350	200	325	200	240	180	180	260	160	250	130	230	
Recommend	◎	◎	◎	◎	◎	◎	◎	◎	◎	◎	◎	◎	◎	◎	◎	◎	◎	◎	◎	◎	

ISO Material Description	N					S										H					
	Aluminum-wrought alloy		Aluminum-cast, alloyed			Copper and Copper Alloys (Bronze / Brass)			Non Metallic Materials		Heat Resistant Super Alloys					Titanium Alloys		Hardened steel	Chilled Cast Iron	Hardened Cast Iron	
VDI 3323	21	22	23	24	25	26	27	28	29	30	31	32	33	34	35	36	37	38	39	40	41
HRC	60	100	75	90	130	110	90	100			15	30	25	38	34	40	55	55	60	42	55
HB	60	100	75	90	130	110	90	100			200	280	250	350	320	400 Rm	1050 Rm	550	630	400	550
Recommend											○	○	○	○	○	○	○	○	○	○	○



PLAIN SHANK

GMG16 SERIES

FLAT SHANK

GMG17 SERIES

CARBIDE, 6 FLUTE CORNER RADIUS LONG LENGTH

- **VOLLHARTMETALL, 6 SCHNEIDEN ECKENRADIUS LANG**
- **CARBURE, 6 DENTS, SÉRIE LONGUE, RAYONNÉE**
- **MD, 6 TAGLIENTI SERIE LUNGA TORICA**

▶ The unique geometry of the variable pitch provides the best chatter free tool for high speed and trochoidal milling
 ▶ Excellent performance for Stainless Steels, Mild Steels, Cast Iron, Low/Medium hardness materials under HRC40

▶ Durch die einzigartige Geometrie und die ungleiche Teilung der Schneiden, eignet sich Fräser Bestens für hohe Bearbeitungsgeschwindigkeiten und trochiodales Fräsen.
 ▶ Exzellente Leistung in Edelstählen, Baustählen, Guss und Stählen unter 40HRC

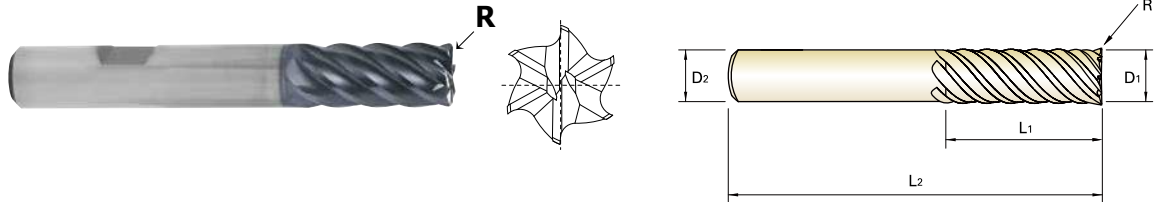

Unit : mm

EDP No.		Corner Radius	Mill Diameter		Shank Diameter		Length of Cut		Overall Length	
PLAIN	FLAT		D1	D2	D2	D1	L1	L2		
GMG16060	GMG17060	R0.5	6.0	6	6	13	57			
GMG16901	GMG17901	R1.0	6.0	6	6	13	57			
GMG16080	GMG17080	R0.5	8.0	8	8	19	63			
GMG16902	GMG17902	R1.0	8.0	8	8	19	63			
GMG16100	GMG17100	R0.5	10.0	10	10	22	72			
GMG16903	GMG17903	R1.0	10.0	10	10	22	72			
GMG16904	GMG17904	R1.5	10.0	10	10	22	72			
GMG16905	GMG17905	R2.0	10.0	10	10	22	72			
GMG16120	GMG17120	R0.5	12.0	12	12	26	83			
GMG16906	GMG17906	R1.0	12.0	12	12	26	83			
GMG16907	GMG17907	R1.5	12.0	12	12	26	83			
GMG16908	GMG17908	R2.0	12.0	12	12	26	83			
GMG16909	GMG17909	R3.0	12.0	12	12	26	83			
GMG16160	GMG17160	R1.0	16.0	16	16	32	92			
GMG16910	GMG17910	R1.5	16.0	16	16	32	92			
GMG16911	GMG17911	R2.0	16.0	16	16	32	92			
GMG16912	GMG17912	R3.0	16.0	16	16	32	92			
GMG16200	GMG17200	R1.0	20.0	20	20	38	104			
GMG16913	GMG17913	R1.5	20.0	20	20	38	104			
GMG16914	GMG17914	R2.0	20.0	20	20	38	104			
GMG16915	GMG17915	R3.0	20.0	20	20	38	104			
GMG16250	GMG17250	R1.0	25.0	25	25	44	104			
GMG16916	GMG17916	R1.5	25.0	25	25	44	104			
GMG16917	GMG17917	R2.0	25.0	25	25	44	104			
GMG16918	GMG17918	R3.0	25.0	25	25	44	104			

Mill Dia. Tolerance (mm)		Shank Dia. Tolerance
Up to Ø12	0 ~ - 0.02	h5
Over Ø12	0 ~ - 0.03	* Shank Dia. ≥ Ø12 : h6

◎ : Excellent ○ : Good

ISO Material Description	P											M				K				
	Non-alloy steel					Low alloy steel				High alloyed steel, and tool steel		Stainless steel				Grey cast iron		Nodular cast iron		Malleable cast iron
VDI 3323	1	2	3	4	5	6	7	8	9	10	11	12	13	14	15	16	17	18	19	20
HRc		13	25	28	32	10	29	32	38	15	35	15	23	10	10	26	3	25		21
HB	125	190	250	270	300	180	275	300	350	200	325	200	240	180	180	260	160	250	130	230
Recommend	◎	◎	◎	◎	◎	◎	◎	◎	◎	◎	◎	◎	◎	◎	◎	◎	◎	◎	◎	◎

ISO Material Description	N										S							H			
	Aluminum-wrought alloy		Aluminum-cast, alloyed			Copper and Copper Alloys (Bronze / Brass)			Non Metallic Materials		Heat Resistant Super Alloys					Titanium Alloys		Hardened steel	Chilled Cast Iron	Hardened Cast Iron	
VDI 3323	21	22	23	24	25	26	27	28	29	30	31	32	33	34	35	36	37	38	39	40	41
HRc											15	30	25	38	34			55	60	42	55
HB	60	100	75	90	130	110	90	100			200	280	250	350	320	400 Rm	1050 Rm	550	630	400	550
Recommend											○	○	○	○	○	○	○				



CARBIDE, 6 FLUTE CORNER RADIUS EXTRA LONG LENGTH

- VOLLHARTMETALL, 6 SCHNEIDEN ECKENRADIUS EXTRA LANG
- CARBURE, 6 DENTS, SÉRIE EXTRA-LONGUE, RAYONNÉE
- MD, 6 TAGLIENTI SERIE EXTRA LUNGA TORICA

▶ The unique geometry of the variable pitch provides the best chatter free tool for high speed and trochoidal milling
 ▶ Excellent performance for Stainless Steels, Mild Steels, Cast Iron, Low/Medium hardness materials under HRC40

▶ Durch die einzigartige Geometrie und die ungleiche Teilung der Schneiden, eignet sich Fräser Bestens für hohe Bearbeitungsgeschwindigkeiten und trochiodales Fräsen.
 ▶ Exzellente Leistung in Edelstählen, Baustählen, Guss und Stählen unter 40HRC

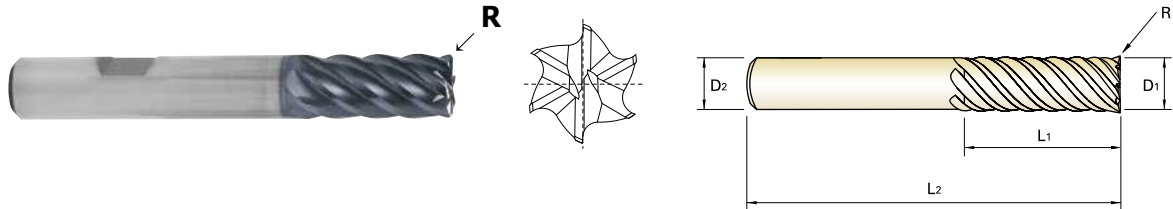

EDP No.		Corner Radius	Mill Diameter	Shank Diameter	Length of Cut	Overall Length
PLAIN	FLAT					
GMG18060	GMG19060	R0.5	6.0	6	24	75
GMG18901	GMG19901	R1.0	6.0	6	24	75
GMG18080	GMG19080	R0.5	8.0	8	32	75
GMG18902	GMG19902	R1.0	8.0	8	32	75
GMG18903	GMG19903	R2.0	8.0	8	32	75
GMG18100	GMG19100	R0.5	10.0	10	40	100
GMG18904	GMG19904	R1.0	10.0	10	40	100
GMG18905	GMG19905	R1.5	10.0	10	40	100
GMG18906	GMG19906	R2.0	10.0	10	40	100
GMG18120	GMG19120	R0.5	12.0	12	48	120
GMG18907	GMG19907	R1.0	12.0	12	48	120
GMG18908	GMG19908	R1.5	12.0	12	48	120
GMG18909	GMG19909	R2.0	12.0	12	48	120
GMG18910	GMG19910	R3.0	12.0	12	48	120
GMG18160	GMG19160	R1.0	16.0	16	64	140
GMG18911	GMG19911	R1.5	16.0	16	64	140
GMG18912	GMG19912	R2.0	16.0	16	64	140
GMG18913	GMG19913	R3.0	16.0	16	64	140
GMG18200	GMG19200	R1.0	20.0	20	80	150
GMG18914	GMG19914	R1.5	20.0	20	80	150
GMG18915	GMG19915	R2.0	20.0	20	80	150
GMG18916	GMG19916	R3.0	20.0	20	80	150
GMG18917	GMG19917	R4.0	20.0	20	80	150
GMG18918	GMG19918	R5.0	20.0	20	80	150

Unit : mm

Mill Dia. Tolerance (mm)	Shank Dia. Tolerance
0 ~ - 0.03	h5 * Shank Dia. ≥ Ø12 : h6

▶ NEXT PAGE

◎ : Excellent ○ : Good

ISO Material Description	P										M				K						
	Non-alloy steel					Low alloy steel					High alloyed steel, and tool steel				Stainless steel		Grey cast iron		Nodular cast iron		Malleable cast iron
VDI 3323	1	2	3	4	5	6	7	8	9	10	11	12	13	14	15	16	17	18	19	20	
HRC		13	25	28	32	10	29	32	38	15	35	15	23	10	10	26	3	25	42	21	
HB	125	190	250	270	300	180	275	300	350	200	325	200	240	180	180	260	160	250	130	230	
Recommend	◎	◎	◎	◎	◎	◎	◎	◎	◎	◎	◎	◎	◎	◎	◎	◎	◎	◎	◎	◎	

ISO Material Description	N					S										H					
	Aluminum-wrought alloy		Aluminum-cast, alloyed		Copper and Copper Alloys (Bronze / Brass)	Non Metallic Materials	Heat Resistant Super Alloys					Titanium Alloys		Hardened steel	Chilled Cast Iron	Hardened Cast Iron					
VDI 3323	21	22	23	24	25	26	27	28	29	30	31	32	33	34	35	36	37	38	39	40	41
HRC											15	30	25	38	34			55	60	42	55
HB	60	100	75	90	130	110	90	100			200	280	250	350	320	400 Rm	1050 Rm	550	630	400	550
Recommend											○	○	○	○	○	○	○				



PLAIN SHANK

GMG18 SERIES

FLAT SHANK

GMG19 SERIES

CARBIDE, 6 FLUTE CORNER RADIUS EXTRA LONG LENGTH

- **VOLLHARTMETALL, 6 SCHNEIDEN ECKENRADIUS EXTRA LANG**
- **CARBURE, 6 DENTS, SÉRIE EXTRA-LONGUE, RAYONNÉE**
- **MD, 6 TAGLIENTI SERIE EXTRA LUNGA TORICA**

- ▶ The unique geometry of the variable pitch provides the best chatter free tool for high speed and trochoidal milling
- ▶ Excellent performance for Stainless Steels, Mild Steels, Cast Iron, Low/Medium hardness materials under HRC40

- ▶ Durch die einzigartige Geometrie und die ungleiche Teilung der Schneiden, eignet sich Fräser Bestens für hohe Bearbeitungsgeschwindigkeiten und trochiodales Fräsen.
- ▶ Exzellente Leistung in Edelstählen, Baustählen, Guss und Stählen unter 40HRc

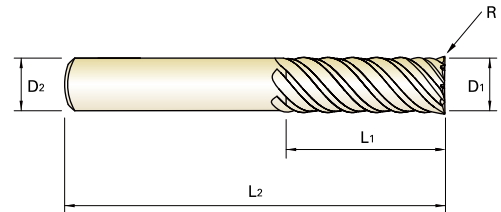
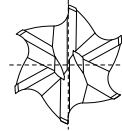

Unit : mm

EDP No.		Corner Radius	Mill Diameter	Shank Diameter	Length of Cut	Overall Length
PLAIN	FLAT		D1	D2	L1	L2
GMG18250	GMG19250	R1.0	25.0	25	100	170
GMG18919	GMG19919	R1.5	25.0	25	100	170
GMG18920	GMG19920	R2.0	25.0	25	100	170
GMG18921	GMG19921	R3.0	25.0	25	100	170
GMG18922	GMG19922	R4.0	25.0	25	100	170
GMG18923	GMG19923	R5.0	25.0	25	100	170

Mill Dia. Tolerance (mm)	Shank Dia. Tolerance
0 ~ - 0.03	h5 * Shank Dia. ≥ Ø12 : h6

◎ : Excellent ○ : Good

ISO Material Description	P											M			K					
	Non-alloy steel					Low alloy steel				High alloyed steel, and tool steel		Stainless steel			Grey cast iron		Nodular cast iron		Malleable cast iron	
VDI 3323	1	2	3	4	5	6	7	8	9	10	11	12	13	14	15	16	17	18	19	20
HRc		13	25	28	32	10	29	32	38	15	35	15	23	10	10	26	3	25		21
HB	125	190	250	270	300	180	275	300	350	200	325	200	240	180	180	260	160	250	130	230
Recommend	◎	◎	◎	◎	◎	◎	◎	◎	◎	◎	◎	◎	◎	◎	◎	◎	◎	◎	◎	◎

ISO Material Description	N									S							H				
	Aluminum-wrought alloy		Aluminum-cast, alloyed			Copper and Copper Alloys (Bronze / Brass)		Non Metallic Materials				Heat Resistant Super Alloys			Titanium Alloys		Hardened steel	Chilled Cast Iron	Hardened Cast Iron		
VDI 3323	21	22	23	24	25	26	27	28	29	30	31	32	33	34	35	36	37	38	39	40	41
HRc											15	30	25	38	34			55	60	42	55
HB	60	100	75	90	130	110	90	100			200	280	250	350	320	400 Rm	1050 Rm	550	630	400	550
Recommend											○	○	○	○	○	○	○				

CARBIDE, 6 FLUTE LONG LENGTH

- VOLLHARTMETALL, 6 SCHNEIDEN, LANG
- CARBURE, 6 DENTS, SÉRIE -LONGUE
- MD, 6 TAGLIENTI SERIE LUNGA

▶ The unique geometry of the variable pitch provides the best chatter free tool for high speed and trochoidal milling
 ▶ Excellent performance for Stainless Steels, Mild Steels, Cast Iron, Low/Medium hardness materials under HRC40

▶ Durch die einzigartige Geometrie und die ungleiche Teilung der Schneiden, eignet sich Fräser Bestens für hohe Bearbeitungsgeschwindigkeiten und trochiodales Fräsen.
 ▶ Exzellente Leistung in Edelstählen, Baustählen, Guss und Stählen unter 40HRC

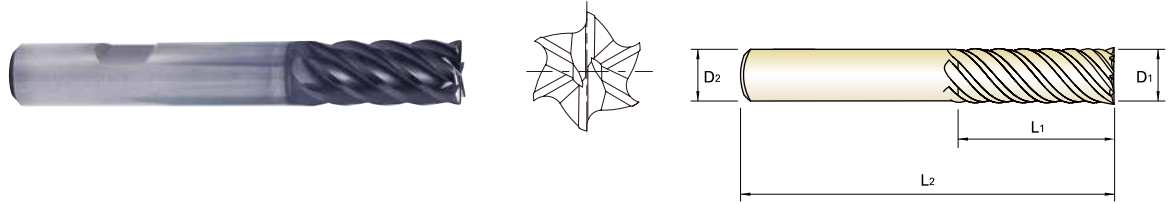

CARBIDE 6 45° PLAIN FLAT P.460

Unit : mm

EDP No.		Mill Diameter	Shank Diameter	Length of Cut	Overall Length
PLAIN	FLAT	D1	D2	L1	L2
GMG12060	GMG13060	6.0	6	13	57
GMG12080	GMG13080	8.0	8	19	63
GMG12100	GMG13100	10.0	10	22	72
GMG12120	GMG13120	12.0	12	26	83
GMG12160	GMG13160	16.0	16	32	92
GMG12200	GMG13200	20.0	20	38	104
GMG12250	GMG13250	25.0	25	44	104

Mill Dia. Tolerance (mm)		Shank Dia. Tolerance
Up to Ø12	0 ~ - 0.02	h5
Over Ø12	0 ~ - 0.03	* Shank Dia. ≥ Ø12 : h6

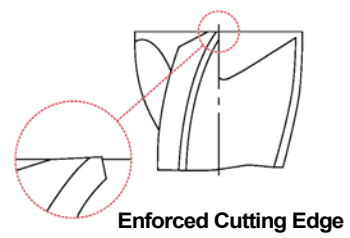

◎ : Excellent ○ : Good

ISO Material Description	P										M				K						
	Non-alloy steel					Low alloy steel					High alloyed steel, and tool steel				Stainless steel		Grey cast iron		Nodular cast iron		Malleable cast iron
VDI 3323	1	2	3	4	5	6	7	8	9	10	11	12	13	14	15	16	17	18	19	20	
HRC	13	25	28	32	10	29	32	38	15	35	15	23	10	10	26	3	25	130	21		
HB	125	190	250	270	300	180	275	300	350	200	325	200	240	180	180	260	160	250	130	230	
Recommend	◎	◎	◎	◎	◎	◎	◎	◎	◎	◎	◎	◎	◎	◎	◎	◎	◎	◎	◎	◎	

ISO Material Description	N					S										H					
	Aluminum-wrought alloy		Aluminum-cast, alloyed		Copper and Copper Alloys (Bronze / Brass)	Non Metallic Materials	Heat Resistant Super Alloys					Titanium Alloys		Hardened steel	Chilled Cast Iron	Hardened Cast Iron					
VDI 3323	21	22	23	24	25	26	27	28	29	30	31	32	33	34	35	36	37	38	39	40	41
HRC	60	100	75	90	130	110	90	100			200	280	250	350	320	400 Rm	1050 Rm	550	630	400	550
Recommend											○	○	○	○	○	○	○				

- CBN END MILLS
- i-Xmill END MILLS
- i-SMART MODULAR END MILLS
- X5070 END MILLS
- 4G MILL END MILLS
- X-POWER PRO END MILLS
- TitaNox-POWER END MILLS
- JET-POWER END MILLS
- V7 PLUS END MILLS
- ALU-POWER HPC END MILLS
- ALU-POWER END MILLS
- D-POWER GRAPHITE END MILLS
- D-POWER CFRP END MILLS
- ROUTERS
- CRX S END MILLS
- K-2 END MILLS
- ONLY ONE COATED PM60 END MILLS
- TANK-POWER END MILLS
- GENERAL HSS END MILLS
- MILLING CUTTERS
- TECHNICAL DATA



PLAIN SHANK

GMG14 SERIES

FLAT SHANK

GMG15 SERIES

CARBIDE, 6 FLUTE EXTRA LONG LENGTH

- **VOLLHARTMETALL, 6 SCHNEIDEN, EXTRA LANG**
- **CARBURE, 6 DENTS, SÉRIE EXTRA-LONGUE**
- **MD, 6 TAGLIENTI SERIE EXTRA LUNGA**

- ▶ The unique geometry of the variable pitch provides the best chatter free tool for high speed and trochoidal milling
- ▶ Excellent performance for Stainless Steels, Mild Steels, Cast Iron, Low/Medium hardness materials under HRc40

- ▶ Durch die einzigartige Geometrie und die ungleiche Teilung der Schneiden, eignet sich Fräser Bestens für hohe Bearbeitungsgeschwindigkeiten und trochiodales Fräsen.
- ▶ Exzellente Leistung in Edelstählen, Baustählen, Guss und Stählen unter 40HRc

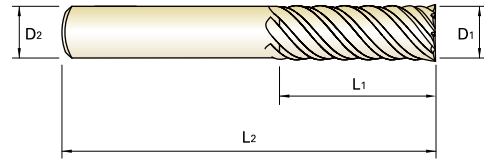
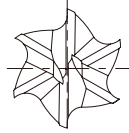

Unit : mm

EDP No.		Mill Diameter	Shank Diameter	Length of Cut	Overall Length
PLAIN	FLAT	D1	D2	L1	L2
GMG14060	GMG15060	6.0	6	24	75
GMG14080	GMG15080	8.0	8	32	75
GMG14100	GMG15100	10.0	10	40	100
GMG14120	GMG15120	12.0	12	48	120
GMG14160	GMG15160	16.0	16	64	140
GMG14200	GMG15200	20.0	20	80	150
GMG14250	GMG15250	25.0	25	100	170

Mill Dia. Tolerance (mm)	Shank Dia. Tolerance
0 ~ - 0.03	h5 * Shank Dia. ≥ Ø12 : h6

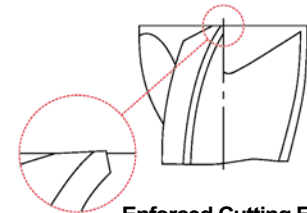

Enforced Cutting Edge

◎ : Excellent ○ : Good

ISO Material Description	P											M			K						
	Non-alloy steel					Low alloy steel						High alloyed steel, and tool steel			Stainless steel			Grey cast iron		Nodular cast iron	
VDI 3323	1	2	3	4	5	6	7	8	9	10	11	12	13	14	15	16	17	18	19	20	
HRc	13	25	28	32	30	10	29	32	38	15	35	15	23	10	10	26	3	25	21	21	
HB	125	190	250	270	300	180	275	300	350	200	325	200	240	180	180	260	160	250	130	230	
Recommend	◎	◎	◎	◎	◎	◎	◎	◎	◎	◎	◎	◎	◎	◎	◎	◎	◎	◎	◎	◎	
ISO Material Description	N									S							H				
	Aluminum-wrought alloy		Aluminum-cast, alloyed			Copper and Copper Alloys (Bronze / Brass)		Non Metallic Materials		Heat Resistant Super Alloys			Titanium Alloys				Hardened steel	Chilled Cast Iron	Hardened Cast Iron		
VDI 3323	21	22	23	24	25	26	27	28	29	30	31	32	33	34	35	36	37	38	39	40	41
HRc	15	30	25	38	34	15	30	25	38	34	200	280	250	350	320	400 Rm	1050 Rm	550	630	400	550
HB	60	100	75	90	130	110	90	100													
Recommend											○	○	○	○	○	○	○				

CARBIDE, 5 FLUTE LONG LENGTH

- VOLLHARTMETALL, 5 SCHNEIDEN LANG
- ⌚ Fraise carbure, 5 dents, longue
- ⌚ 5 TAGLIANTI, SERIE LUNGA, EVOLVENTE VARIABILE

- ▶ Special flute geometry eliminates vibrations
- ▶ Designed for mild steels, stainless steels, cast iron, tool steels, titanium alloys, prehardened steels and low hardness materials under HRc40
- ▶ Excellent finished work piece
- ▶ Higher speeds, deeper cuts and excellent metal removal rates

- ▶ Spezielle Schneidengeometrie verhindert Vibrationen
- ▶ Geeignet für Baustähle, Rostfreie Stähle, Grauguss, Werkzeugstähle, Titanlegierungen, hochfeste Stähle und Werkstoffe unter 40 HRc
- ▶ Bessere Werkstückoberflächen.
- ▶ Höhere Schnittgeschwindigkeiten, größere Profiltiefe und größeres Zerspanungsvolumen



Unit : mm

EDP No.		Mill Diameter	Shank Diameter	Length of Cut	Overall Length	Chamfer
PLAIN	FLAT					
EMB72060	EMB73060	6.0	6	13	57	0.1
EMB72080	EMB73080	8.0	8	19	63	0.1
EMB72100	EMB73100	10.0	10	22	72	0.1
EMB72120	EMB73120	12.0	12	26	83	0.1
EMB72140	EMB73140	14.0	14	26	83	0.2
EMB72160	EMB73160	16.0	16	32	92	0.2
EMB72180	EMB73180	18.0	18	32	92	0.2
EMB72200	EMB73200	20.0	20	38	104	0.2
EMB72250	EMB73250	25.0	25	38	104	0.2

Mill Dia. Tolerance (mm)	Shank Dia. Tolerance
0 ~ - 0.03	h5 * Shank Dia. ≥ Ø12 : h6

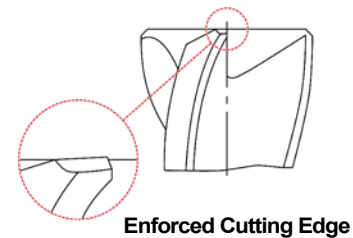

◎ : Excellent ○ : Good

ISO	P										M				K						
	Non-alloy steel					Low alloy steel					High alloyed steel, and tool steel				Stainless steel		Grey cast iron		Nodular cast iron		Malleable cast iron
Material Description	1	2	3	4	5	6	7	8	9	10	11	12	13	14	15	16	17	18	19	20	
VDI 3323	1	2	3	4	5	6	7	8	9	10	11	12	13	14	15	16	17	18	19	20	
HRC	13	25	28	32	30	10	29	32	38	15	35	15	23	10	10	26	3	25	21	21	
HB	125	190	250	270	300	180	275	300	350	200	325	200	240	180	180	260	160	250	130	230	
Recommend	◎	◎	○	○	○	◎	○	○	○	◎	◎	◎	◎	◎	○	○	○	○	○	○	

ISO	N										S						H				
	Aluminum-wrought alloy		Aluminum-cast, alloyed			Copper and Copper Alloys (Bronze / Brass)			Non Metallic Materials		Heat Resistant Super Alloys				Titanium Alloys		Hardened steel	Chilled Cast Iron	Hardened Cast Iron		
Material Description	21	22	23	24	25	26	27	28	29	30	31	32	33	34	35	36	37	38	39	40	41
VDI 3323	21	22	23	24	25	26	27	28	29	30	31	32	33	34	35	36	37	38	39	40	41
HRC	60	100	75	90	130	110	90	100			200	280	250	350	320	400 Rm	1050 Rm	550	630	400	550
Recommend	○	○	○	○	○	○	○	○	○	○	○	○	○	○	○	◎	◎	○	○	○	○

CBN END MILLS

i-Xmill END MILLS

i-SMART MODULAR END MILLS

X5070 END MILLS

4G MILL END MILLS

X-POWER PRO END MILLS

TitaNox-POWER END MILLS

JET-POWER END MILLS

V7 PLUS END MILLS

ALU-POWER HPC END MILLS

ALU-POWER END MILLS

D-POWER GRAPHITE END MILLS

D-POWER CFRP END MILLS

ROUTERS

CRX S END MILLS

K-2 END MILLS

ONLY ONE COATED PM60 END MILLS

TANK-POWER END MILLS

GENERAL HSS END MILLS

MILLING CUTTERS

TECHNICAL DATA

GMG55, GMG56 SERIES **4 FLUTE BALL NOSE**

Vc = m/min.
fz = mm/tooth
RPM = rev./min.
FEED = mm/min.

ISO	VDI 3323	Material Description	Ae	Ap	Parameter	Diameter (Ø)												
						3.0	4.0	5.0	6.0	8.0	10.0	12.0	16.0	18.0	20.0	25.0		
P	1-4	Non-alloy steel	0.5D	1.0D	Vc	162	162	162	162	162	162	162	162	162	162	162	162	162
					fz	0.025	0.027	0.03	0.04	0.06	0.065	0.07	0.075	0.08	0.09	0.099		
					RPM	17189	12892	10313	8594	6446	5157	4297	3223	2865	2578	2063		
	5	Low alloy steel	0.5D	1.0D	Vc	113	113	113	113	113	113	113	113	113	113	113	113	
					fz	0.025	0.027	0.03	0.04	0.06	0.065	0.07	0.074	0.079	0.09	0.099		
RPM					11990	8992	7194	5995	4496	3597	2997	2248	1998	1798	1439			
6-7	High alloyed steel, and tool steel	0.5D	1.0D	Vc	162	162	162	162	162	162	162	162	162	162	162	162		
				fz	0.025	0.027	0.03	0.04	0.06	0.065	0.07	0.075	0.08	0.09	0.099			
				RPM	17189	12892	10313	8594	6446	5157	4297	3223	2865	2578	2063			
8-9	Stainless steel	0.5D	1.0D	Vc	113	113	113	113	113	113	113	113	113	113	113	113		
				fz	0.025	0.027	0.03	0.04	0.06	0.065	0.07	0.074	0.079	0.09	0.099			
				RPM	11990	8992	7194	5995	4496	3597	2997	2248	1998	1798	1439			
10-11.1	Grey cast iron	0.5D	1.0D	Vc	68	68	68	68	68	68	68	68	68	68	68	68		
				fz	0.017	0.019	0.021	0.028	0.042	0.045	0.049	0.052	0.056	0.063	0.07			
				RPM	7215	5411	4329	3608	2706	2165	1804	1353	1203	1082	866			
M	12-13	Heat Resistant Super Alloys	0.5D	1.0D	Vc	77	77	77	77	77	77	77	77	77	77	77		
					fz	0.015	0.015	0.025	0.03	0.04	0.045	0.05	0.054	0.059	0.058	0.059		
					RPM	8170	6127	4902	4085	3064	2451	2042	1532	1362	1225	980		
14.1	Titanium Alloys	0.5D	1.0D	Vc	85	85	85	85	85	85	85	85	85	85	85	85		
				fz	0.02	0.02	0.025	0.041	0.045	0.05	0.055	0.06	0.064	0.065	0.068			
				RPM	9019	6764	5411	4509	3382	2706	2255	1691	1503	1353	1082			
14.2	Titanium Alloys	0.5D	1.0D	Vc	77	77	77	77	77	77	77	77	77	77	77	77		
				fz	0.02	0.02	0.025	0.041	0.045	0.05	0.055	0.06	0.064	0.065	0.068			
				RPM	8170	6127	4902	4085	3064	2451	2042	1532	1362	1225	980			
K	15-20	Titanium Alloys	0.5D	1.0D	Vc	119	119	119	119	119	119	119	119	119	119	119		
					fz	0.031	0.033	0.037	0.05	0.074	0.081	0.087	0.093	0.099	0.112	0.124		
					RPM	12626	9470	7576	6313	4735	3788	3157	2367	2104	1894	1515		
S	31-35	Titanium Alloys	0.5D	0.3D	Vc	21	21	21	21	21	21	21	21	21	21	21		
					fz	0.014	0.014	0.017	0.028	0.031	0.035	0.038	0.042	0.045	0.045	0.048		
					RPM	2228	1671	1337	1114	836	668	557	418	371	334	267		
36-37	Titanium Alloys	0.5D	0.3D	Vc	47	47	47	47	47	47	47	47	47	47	47			
				fz	0.018	0.018	0.022	0.037	0.04	0.045	0.049	0.054	0.058	0.058	0.061			
				RPM	4987	3740	2992	2493	1870	1496	1247	935	831	748	598			

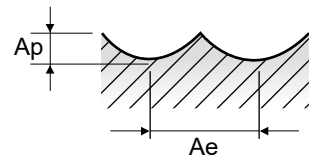

GMF52 GMF53 **GMF54 GMF55** **GMF56 GMF57** **GMF58 GMF59** **GMF60 GMF61** **GMF62 GMF63**

4 FLUTE - SIDE & SLOTING

Vc = m/min.
fz = mm/tooth
RPM = rev./min.
FEED = mm/min.

ISO	VDI 3323	Material Description	Ae		Ap		Parameter	Diameter (Ø)												
			Side	Slotting	Side	Slotting		3.0	4.0	5.0	6.0	8.0	10.0	12.0	14.0	16.0	18.0	20.0	25.0	
P	1-4	Non-alloy steel	0.5D	1.0D	1.5D (1.2D)	1.0D (0.8D)	Vc	152	152	152	152	152	168	168	168	168	168	168	168	168
							fz	0.005	0.008	0.011	0.016	0.027	0.038	0.047	0.049	0.053	0.059	0.065	0.064	
							RPM	16128	12096	9677	8064	6048	5348	4456	3820	3342	2971	2674	2139	
	5	Low alloy steel	0.5D	1.0D	1.5D (1.2D)	1.0D (0.8D)	Vc	107	107	107	107	107	117	117	117	117	117	117	117	117
							fz	0.005	0.008	0.011	0.016	0.027	0.038	0.047	0.049	0.053	0.059	0.065	0.064	
							RPM	11353	8515	6812	5677	4257	3724	3104	2660	2328	2069	1862	1490	
	6-7	Low alloy steel	0.5D	1.0D	1.5D (1.2D)	1.0D (0.8D)	Vc	152	152	152	152	152	168	168	168	168	168	168	168	168
							fz	0.005	0.008	0.011	0.016	0.027	0.038	0.047	0.049	0.053	0.059	0.065	0.064	
							RPM	16128	12096	9677	8064	6048	5348	4456	3820	3342	2971	2674	2139	
	8-9	Low alloy steel	0.5D	1.0D	1.5D (1.2D)	1.0D (0.8D)	Vc	107	107	107	107	107	117	117	117	117	117	117	117	117
							fz	0.005	0.008	0.011	0.016	0.027	0.038	0.047	0.049	0.053	0.059	0.065	0.064	
							RPM	11353	8515	6812	5677	4257	3724	3104	2660	2328	2069	1862	1490	
	10-11.1	High alloyed steel, and tool steel	0.5D	1.0D	1.5D (1.2D)	1.0D (0.8D)	Vc	64	64	64	64	64	70	70	70	70	70	70	70	70
							fz	0.003	0.006	0.008	0.011	0.019	0.027	0.032	0.034	0.037	0.041	0.045	0.045	
							RPM	6791	5093	4074	3395	2546	2228	1857	1592	1393	1238	1114	891	
M	12-13	Stainless steel	0.5D	1.0D	1.5D (1.2D)	1.0D (0.8D)	Vc	148	148	148	148	148	148	148	148	148	148	148	148	148
							fz	0.004	0.006	0.009	0.013	0.022	0.034	0.039	0.042	0.045	0.05	0.055	0.055	
							RPM	15703	11777	9422	7852	5889	4711	3926	3365	2944	2617	2355	1884	
	14.1	Stainless steel	0.5D	1.0D	1.5D (1.2D)	1.0D (0.8D)	Vc	106	106	106	106	106	106	106	106	106	106	106	106	106
							fz	0.005	0.008	0.013	0.018	0.028	0.048	0.055	0.059	0.062	0.07	0.077	0.077	
							RPM	11247	8435	6748	5623	4218	3374	2812	2410	2109	1874	1687	1350	
	14.2	Stainless steel	0.5D	1.0D	1.5D (1.2D)	1.0D (0.8D)	Vc	95	95	95	95	95	95	95	95	95	95	95	95	95
							fz	0.005	0.008	0.013	0.018	0.028	0.048	0.055	0.059	0.062	0.069	0.076	0.076	
							RPM	10080	7560	6048	5040	3780	3024	2520	2160	1890	1680	1512	1210	
K	15-20	Grey cast iron	0.5D	1.0D	1.5D (1.2D)	1.0D (0.8D)	Vc	112	112	112	112	112	123	123	123	123	123	123	123	123
							fz	0.006	0.01	0.014	0.02	0.034	0.048	0.058	0.061	0.065	0.073	0.081	0.079	
							RPM	11884	8913	7130	5942	4456	3915	3263	2797	2447	2175	1958	1566	
S	31-35	Heat Resistant Super Alloys	0.25D	1.0D	1.0D	0.5D	Vc	26	26	26	26	26	26	26	26	26	26	26	26	26
							fz	0.005	0.007	0.008	0.012	0.019	0.033	0.038	0.04	0.043	0.048	0.054	0.052	
							RPM	2759	2069	1655	1379	1035	828	690	591	517	460	414	331	
	36-37	Titanium Alloys	0.4D	1.0D	1.0D	0.5D	Vc	58	58	58	58	58	58	58	58	58	58	58	58	58
							fz	0.004	0.007	0.011	0.016	0.025	0.042	0.05	0.053	0.055	0.062	0.068	0.069	
							RPM	6154	4615	3692	3077	2308	1846	1538	1319	1154	1026	923	738	

*() : Short length & Neck type

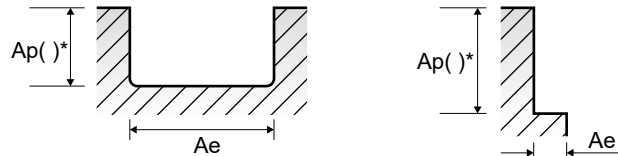

GMG16 GMG17 **GMG18 GMG19** **GMG12 GMG13** **GMG14 GMG15**

6 FLUTE - SIDE CUTTING

Vc = m/min.
fz = mm/tooth
RPM = rev./min.
FEED = mm/min.

ISO	VDI 3323	Material Description	Ae	Ap	Parameter	Diameter (Ø)							
						6.0	8.0	10.0	12.0	16.0	20.0	25.0	
P	1-4	Non-alloy steel	0.05D	2.0D	Vc	300	300	300	300	300	300	300	
					fz	0.068	0.116	0.144	0.173	0.202	0.225	0.232	
					RPM	15915	11937	9549	7958	5968	4775	3820	
	5	Low alloy steel	0.05D	2.0D	Vc	203	203	203	203	203	203	203	
					fz	0.05	0.085	0.106	0.128	0.149	0.167	0.174	
					RPM	10769	8077	6462	5385	4039	3231	2585	
	6-7	Low alloy steel	0.05D	2.0D	Vc	300	300	300	300	300	300	300	
					fz	0.068	0.116	0.144	0.173	0.202	0.225	0.232	
					RPM	15915	11937	9549	7958	5968	4775	3820	
	8-9	Low alloy steel	0.05D	2.0D	Vc	203	203	203	203	203	203	203	
					fz	0.05	0.085	0.106	0.128	0.149	0.167	0.174	
					RPM	10769	8077	6462	5385	4039	3231	2585	
10-11.1	High alloyed steel, and tool steel	0.05D	2.0D	Vc	100	100	100	100	100	100	100		
				fz	0.041	0.071	0.088	0.105	0.123	0.137	0.144		
				RPM	5305	3979	3183	2653	1989	1592	1273		
M	12-13	Stainless steel	0.05D	2.0D	Vc	213	213	213	213	213	213	213	
					fz	0.049	0.084	0.104	0.125	0.146	0.162	0.168	
					RPM	11300	8475	6780	5650	4238	3390	2712	
	14.1	Stainless steel	0.05D	2.0D	Vc	147	147	147	147	147	147	147	
					fz	0.041	0.071	0.088	0.105	0.123	0.137	0.143	
					RPM	7799	5849	4679	3899	2924	2340	1872	
	14.2	Stainless steel	0.05D	2.0D	Vc	134	134	134	134	134	134	134	
					fz	0.041	0.071	0.088	0.105	0.123	0.137	0.142	
					RPM	7109	5332	4265	3554	2666	2133	1706	
	S	31-35	Heat Resistant Super Alloys	0.05D	2.0D	Vc	33	33	33	33	33	33	33
						fz	0.033	0.055	0.07	0.082	0.097	0.112	0.115
						RPM	1751	1313	1050	875	657	525	420
36-37		Titanium Alloys	0.05D	2.0D	Vc	116	116	116	116	116	116	116	
					fz	0.033	0.055	0.07	0.083	0.097	0.113	0.117	
					RPM	6154	4615	3692	3077	2308	1846	1477	

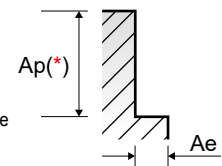

(*) : If product's Length of Cut(L.O.C) is below 2D, it must be applied with L.O.C x 90%

EMB72, EMB73 SERIES

5 FLUTE - SIDE CUTTING

Vc = m/min.
fz = mm/tooth
RPM = rev./min.
FEED = mm/min.

ISO	VDI 3323	Material Description	Ae	Ap	Parameter	Diameter (Ø)						
						6.0	8.0	10.0	12.0	14.0	16.0	20.0
P	1-2	Non-alloy steel	0.25D	1.25D	Vc	135	135	135	135	135	135	135
					fz	0.034	0.038	0.050	0.063	0.069	0.076	0.089
					RPM	7162	5371	4297	3581	3069	2686	2149
	6		0.25D	1.25D	Vc	135	135	135	135	135	135	135
					fz	0.034	0.038	0.050	0.063	0.069	0.076	0.089
					RPM	7162	5371	4297	3581	3069	2686	2149
	10	High alloyed steel, and tool steel	0.25D	1.25D	Vc	135	135	135	135	135	135	135
					fz	0.034	0.038	0.050	0.063	0.069	0.076	0.089
					RPM	7162	5371	4297	3581	3069	2686	2149
M	12-13	Stainless steel	0.25D	1.25D	Vc	105	105	105	145	105	105	105
					fz	0.030	0.032	0.038	0.043	0.064	0.068	0.076
					RPM	5570	4178	3342	3846	2387	2089	1671
	14.1		0.25D	1.25D	Vc	115	115	115	115	115	115	115
					fz	0.030	0.032	0.038	0.063	0.065	0.069	0.076
					RPM	6101	4576	3661	3050	2615	2288	1830
K	15-20	Grey cast iron	0.25D	1.25D	Vc	135	135	135	135	135	135	135
					fz	0.034	0.038	0.050	0.063	0.069	0.076	0.089
					RPM	7162	5371	4297	3581	3069	2686	2149
S	31-35	Heat Resistant Super Alloys	0.25D	1.0D	Vc	25	25	25	25	25	25	25
					fz	0.017	0.020	0.025	0.036	0.045	0.048	0.060
					RPM	1326	995	796	663	568	497	398
	36-37	Titanium Alloys	0.25D	1.25D	Vc	85	85	85	85	85	85	85
					fz	0.030	0.031	0.038	0.050	0.057	0.063	0.075
					RPM	4509	3382	2706	2255	1933	1691	1353
FEED						1218	1021	1074	1128	1059	1021	956

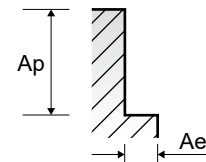



Global Cutting Tool Leader **YG-1**



MILLING



Leading Through Innovation

SOLID CARBIDE

ALU-POWER HPC END MILLS

Alu Power HPC VHM Fräser

- For Aluminium, Aluminum Die Cast, Non-ferrous Alloys and Plastics
- Für Aluminium, Aluminiumdruckguss, Nichteisenlegierungen und Kunststoffe

SELECTION GUIDE



SERIES	E5H24 JAH24	E5H25 JAH25	E5H22 JAH22	E5H23 JAH23
FLUTE	3	3	3	3
HELIX ANGLE	37°	37°	37°	37°
CUTTING EDGE SHAPE	CORNER RADIUS	CORNER RADIUS	SQUARE	SQUARE
SIZE MIN	D6.0	D6.0	D3.0	D6.0
SIZE MAX	D20.0	D20.0	D25.0	D20.0
PAGE	466	469	472	473

SOLID CARBIDE
ALU-POWER HPC
END MILLS

3-Flute, High-Performance,
 For Aluminum, Aluminum Die Cast,
 Non-Ferrous Alloys And Plastics

-	EXTENDED NECK	-	EXTENDED NECK
Uncoated	Uncoated	Uncoated	Uncoated
DLC	DLC	DLC	DLC



Please visit
globalyg1.com/mat
 for material search

◎ : Excellent ○ : Good

Recommended cutting conditions : P 474

ISO	VDI 3323	Material Description	Composition / Structure / Heat Treatment	HB	HRc				
P	1	Non-alloy steel	About 0.15% C Annealed	125					
	2		About 0.45% C Annealed	190	13				
	3		About 0.45% C Quenched & Tempered	250	25				
	4		About 0.75% C Annealed	270	28				
	5		About 0.75% C Quenched & Tempered	300	32				
	6	Low alloy steel	Annealed	180	10				
	7		Quenched & Tempered	275	29				
	8		Quenched & Tempered	300	32				
	9		Quenched & Tempered	350	38				
	10		High alloyed steel, and tool steel	Annealed	200	15			
	11	Quenched & Tempered		325	35				
M	12	Stainless steel	Ferritic / Martensitic Annealed	200	15				
	13		Martensitic Quenched & Tempered	240	23				
	14	Austenitic	180	10					
K	15	Grey cast iron	Pearlitic / ferritic	180	10				
	16		Pearlitic (Martensitic)	260	26				
	17	Nodular cast iron	Ferritic	160	3				
	18		Pearlitic	250	25				
	19		Ferritic	130					
20	Malleable cast iron	Pearlitic	230	21					
N	21	Aluminum-wrought alloy	Not Curable	60		◎	◎	◎	◎
	22		Curable Hardened	100		◎	◎	◎	◎
	23	Aluminum-cast, alloyed	≤ 12% Si, Not Curable	75		◎	◎	◎	◎
	24		≤ 12% Si, Curable Hardened	90		◎	◎	◎	◎
	25		> 12% Si, Not Curable	130		○	○	○	○
	26		Copper and Copper Alloys (Bronze / Brass)	Cutting Alloys, PB>1% CuZn, CuSnZn (Brass) CuSn, lead-free copper and electrolytic copper	110 90 100		○	○	○
	27	Non Metallic Materials	Duroplastic, Fiber Reinforced Plastic			○	○	○	○
	28		Rubber, Wood, etc.			○	○	○	○
	29						○	○	○
	30								
S	31	Heat Resistant Super Alloys	Fe Based Annealed	200	15				
	32		Cured	280	30				
	33		Annealed	250	25				
	34		Ni or Co Based Cured	350	38				
	35	Cast	320	34					
	36	Titanium Alloys	Pure Titanium	400 Rm					
	37		Alpha + Beta Alloys Hardened	1050 Rm					
H	38	Hardened steel	Hardened	550	55				
	39		Hardened	630	60				
	40	Chilled Cast Iron	Cast	400	42				
	41	Hardened Cast Iron	Hardened	550	55				

Scan QR Code to See Catalogue
**AEROSPACE SOLUTIONS &
COMPOSITE MATERIALS**

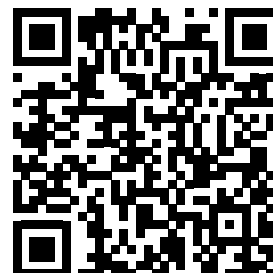

CARBIDE, 3 FLUTE 37° HELIX CORNER RADIUS

- Vollhartmetall, 3 Schneiden 37° Eckradius
- Fraise carbure, 3 dents, torique, hélice 37°
- 3 TAGLIENTI, ELICA 37°, SPIGOLO RAGGIATO

- ▶ Balanced cutting with less vibration
- ▶ Ability to run at higher speeds with less heat in aluminum
- ▶ More efficient chip evacuation
- ▶ Ability to counteract extreme radial forces
- ▶ DLC Coating provides edge strength and unsurpassed tool life

- ▶ Ausgewogenes Fräsen, mit weniger Vibrationen
- ▶ Höhere Schnittgeschwindigkeiten möglich bei weniger Wärmeeinbringung in den Werkstoff Aluminium
- ▶ Effizientere Spanabfuhr
- ▶ Fähigkeit, extremen Radialkräften entgegenzuwirken
- ▶ Die DLC-Beschichtung bietet Kantenfestigkeit und unübertroffene Standzeit

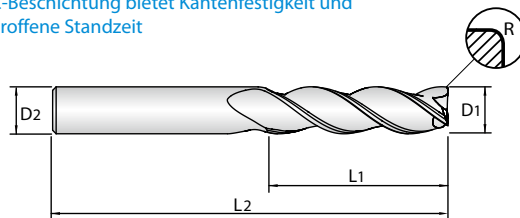
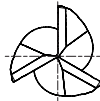

Unit : mm

EDP No.		Corner Radius	Mill Diameter	Shank Diameter	Length of Cut	Overall Length
Uncoated	DLC	R	D1	D2	L1	L2
E5H24060	JAH24060	R0.5	6.0	6	13	57
E5H24901	JAH24901	R1.0	6.0	6	13	57
E5H24902	JAH24902	R1.5	6.0	6	13	57
E5H24903	JAH24903	R0.8	6.0	6	13	72
E5H24904	JAH24904	R1.2	6.0	6	13	72
E5H24905	JAH24905	R0.5	6.0	6	24	75
E5H24906	JAH24906	R1.0	6.0	6	24	75
E5H24080	JAH24080	R0.3	8.0	8	19	63
E5H24907	JAH24907	R0.5	8.0	8	19	63
E5H24908	JAH24908	R1.0	8.0	8	19	63
E5H24909	JAH24909	R1.5	8.0	8	19	63
E5H24910	JAH24910	R0.5	8.0	8	32	75
E5H24911	JAH24911	R1.0	8.0	8	32	75
E5H24912	JAH24912	R1.5	8.0	8	32	75
E5H24913	JAH24913	R2.0	8.0	8	32	75
E5H24100	JAH24100	R0.3	10.0	10	22	72
E5H24914	JAH24914	R0.5	10.0	10	22	72
E5H24915	JAH24915	R1.0	10.0	10	22	72
E5H24916	JAH24916	R1.5	10.0	10	22	72
E5H24917	JAH24917	R0.5	10.0	10	40	100

▶ NEXT PAGE

Mill Diameter Tolerances (mm)		Shank Diameter Tolerance
Diameter	Tolerance	
Up to 3	+0/-0.006	h5
Over 3 ~ up to 6	+0/-0.008	
Over 6 ~ up to 10	+0/-0.009	
Over 10 ~ up to 18	+0/-0.011	
Over 18 ~ up to 25	+0/-0.013	

◎ : Excellent ○ : Good

ISO Material Description	P											M				K								
	Non-alloy steel					Low alloy steel						High alloyed steel, and tool steel				Stainless steel				Grey cast iron		Nodular cast iron		Malleable cast iron
VDI 3323	1	2	3	4	5	6	7	8	9	10	11	12	13	14	15	16	17	18	19	20				
HRc		13	25	28	32	10	29	32	38	15	35	15	23	10	10	26	3	25						
HB	125	190	250	270	300	180	275	300	350	200	325	200	240	180	180	260	160	250	130	230				
Recommend																								
ISO Material Description	N										S							H						
	Aluminum-wrought alloy		Aluminum-cast, alloyed			Copper and Copper Alloys (Bronze / Brass)			Non Metallic Materials		Heat Resistant Super Alloys							Titanium Alloys		Hardened steel	Chilled Cast Iron	Hardened Cast Iron		
VDI 3323	21	22	23	24	25	26	27	28	29	30	31	32	33	34	35	36	37	38	39	40	41			
HRc											15	30	25	38	34			55	60	42	55			
HB	60	100	75	90	130	110	90	100			200	280	250	350	320	400 Rm	1050 Rm	550	630	400	550			
Recommend	◎	◎	◎	◎	○	○	○	○	○	○														

CARBIDE, 3 FLUTE 37° HELIX CORNER RADIUS

- Vollhartmetall, 3 Schneiden 37° Eckradius
- Fraise carbure, 3 dents, torique, hélice 37°
- 3 TAGLIANTI, ELICA 37°, SPIGOLO RAGGIATO

- ▶ Balanced cutting with less vibration
- ▶ Ability to run at higher speeds with less heat in aluminum
- ▶ More efficient chip evacuation
- ▶ Ability to counteract extreme radial forces
- ▶ DLC Coating provides edge strength and unsurpassed tool life

- ▶ Ausgewogenes Fräsen, mit weniger Vibrationen
- ▶ Höhere Schnittgeschwindigkeiten möglich bei weniger Wärmeinbringung in den Werkstoff Aluminium
- ▶ Effizientere Spanabfuhr
- ▶ Fähigkeit, extremen Radialkräften entgegenzuwirken
- ▶ Die DLC-Beschichtung bietet Kantenfestigkeit und unübertroffene Standzeit

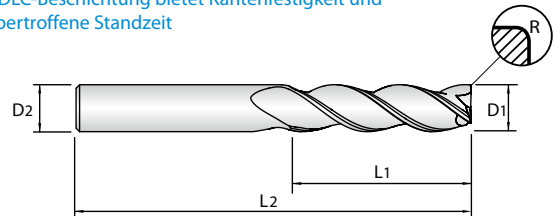
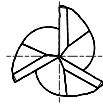

Unit : mm

EDP No.		Corner Radius	Mill Diameter	Shank Diameter	Length of Cut	Overall Length
Uncoated	DLC	R	D ₁	D ₂	L ₁	L ₂
E5H24918	JAH24918	R1.0	10.0	10	40	100
E5H24919	JAH24919	R1.5	10.0	10	40	100
E5H24920	JAH24920	R2.0	10.0	10	40	100
E5H24120	JAH24120	R1.5	12.0	12	26	83
E5H24921	JAH24921	R2.0	12.0	12	26	83
E5H24922	JAH24922	R2.5	12.0	12	26	83
E5H24923	JAH24923	R3.0	12.0	12	26	83
E5H24924	JAH24924	R0.5	12.0	12	48	100
E5H24925	JAH24925	R1.0	12.0	12	48	100
E5H24926	JAH24926	R1.5	12.0	12	48	100
E5H24927	JAH24927	R2.0	12.0	12	48	100
E5H24928	JAH24928	R2.5	12.0	12	48	100
E5H24929	JAH24929	R3.0	12.0	12	48	100
E5H24140	JAH24140	R1.0	14.0	14	30	89
E5H24930	JAH24930	R2.0	14.0	14	30	89
E5H24931	JAH24931	R3.0	14.0	14	30	89
E5H24160	JAH24160	R1.5	16.0	16	32	92
E5H24932	JAH24932	R2.0	16.0	16	32	92
E5H24933	JAH24933	R2.5	16.0	16	32	92
E5H24934	JAH24934	R3.0	16.0	16	32	92

▶ NEXT PAGE

Mill Diameter Tolerances (mm)		Shank Diameter Tolerance
Diameter	Tolerance	
Up to 3	+0/-0.006	h5
Over 3 ~ up to 6	+0/-0.008	
Over 6 ~ up to 10	+0/-0.009	
Over 10 ~ up to 18	+0/-0.011	
Over 18 ~ up to 25	+0/-0.013	

◎ : Excellent ○ : Good

ISO Material Description	P										M				K						
	Non-alloy steel					Low alloy steel					High alloyed steel, and tool steel				Stainless steel		Grey cast iron		Nodular cast iron		Malleable cast iron
VDI 3323	1	2	3	4	5	6	7	8	9	10	11	12	13	14	15	16	17	18	19	20	
HRC																					
HB	125	190	250	270	300	180	275	300	350	200	325	200	240	180	180	260	160	250	130	230	
Recommend																					

ISO Material Description	N					S					H											
	Aluminum-wrought alloy		Aluminum-cast, alloyed		Copper and Copper Alloys (Bronze / Brass)	Non Metallic Materials	Heat Resistant Super Alloys				Titanium Alloys		Hardened steel	Chilled Cast Iron	Hardened Cast Iron							
VDI 3323	21	22	23	24	25	26	27	28	29	30	31	32	33	34	35	36	37	38	39	40	41	
HRC																						
HB	60	100	75	90	130	110	90	100			15	30	25	38	34	200	280	250	350	320	400 Rm	1050 Rm
Recommend	◎	◎	◎	◎	◎	◎	◎	◎	◎	◎												

YG ALU-POWER HPC END MILLS

UNCOATED

E5H24 SERIES

DLC COATED

JAH24 SERIES

PLAIN SHANK

CARBIDE, 3 FLUTE 37° HELIX CORNER RADIUS

- Vollhartmetall, 3 Schneiden 37° Eckradius
- Fraise carbure, 3 dents, torique, hélice 37°
- 3 TAGLIENTI, ELICA 37°, SPIGOLO RAGGIATO

- ▶ Balanced cutting with less vibration
- ▶ Ability to run at higher speeds with less heat in aluminum
- ▶ More efficient chip evacuation
- ▶ Ability to counteract extreme radial forces
- ▶ DLC Coating provides edge strength and unsurpassed tool life

- ▶ Ausgewogenes Fräsen, mit weniger Vibrationen
- ▶ Höhere Schnittgeschwindigkeiten möglich bei weniger Wärmeeinbringung in den Werkstoff Aluminium
- ▶ Effizientere Spanabfuhr
- ▶ Fähigkeit, extremen Radialkräften entgegenzuwirken
- ▶ Die DLC-Beschichtung bietet Kantenfestigkeit und unübertroffene Standzeit

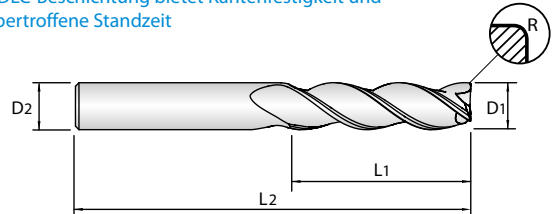
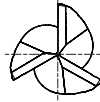

Unit : mm

EDP No.		Corner Radius	Mill Diameter	Shank Diameter	Length of Cut	Overall Length
Uncoated	DLC	R	D1	D2	L1	L2
E5H24935	JAH24935	R4.0	16.0	16	32	92
E5H24936	JAH24936	R0.5	16.0	16	64	125
E5H24937	JAH24937	R1.0	16.0	16	64	125
E5H24938	JAH24938	R1.5	16.0	16	64	125
E5H24939	JAH24939	R2.0	16.0	16	64	125
E5H24940	JAH24940	R2.5	16.0	16	64	125
E5H24941	JAH24941	R3.0	16.0	16	64	125
E5H24942	JAH24942	R4.0	16.0	16	64	125
E5H24200	JAH24200	R2.0	20.0	20	38	104
E5H24943	JAH24943	R2.5	20.0	20	38	104
E5H24944	JAH24944	R3.0	20.0	20	38	104
E5H24945	JAH24945	R4.0	20.0	20	38	104
E5H24946	JAH24946	R0.5	20.0	20	80	150
E5H24947	JAH24947	R1.0	20.0	20	80	150
E5H24948	JAH24948	R1.5	20.0	20	80	150
E5H24949	JAH24949	R2.0	20.0	20	80	150
E5H24950	JAH24950	R2.5	20.0	20	80	150
E5H24951	JAH24951	R3.0	20.0	20	80	150
E5H24952	JAH24952	R4.0	20.0	20	80	150

Mill Diameter Tolerances (mm)		Shank Diameter Tolerance
Diameter	Tolerance	
Up to 3	+0/-0.006	h5
Over 3 ~ up to 6	+0/-0.008	
Over 6 ~ up to 10	+0/-0.009	
Over 10 ~ up to 18	+0/-0.011	
Over 18 ~ up to 25	+0/-0.013	

◎ : Excellent ○ : Good

ISO Material Description	P									M				K							
	Non-alloy steel					Low alloy steel				High alloyed steel, and tool steel				Stainless steel		Grey cast iron		Nodular cast iron		Malleable cast iron	
VDI 3323	1	2	3	4	5	6	7	8	9	10	11	12	13	14	15	16	17	18	19	20	
HRc		13	25	28	32	10	29	32	38	15	35	15	23	10	10	26	3	25		21	
HB	125	190	250	270	300	180	275	300	350	200	325	200	240	180	180	260	160	250	130	230	
Recommend																					
ISO Material Description	N					S					H										
	Aluminum-wrought alloy		Aluminum-cast, alloyed			Copper and Copper Alloys (Bronze / Brass)			Non Metallic Materials		Heat Resistant Super Alloys					Titanium Alloys		Hardened steel	Chilled Cast Iron		Hardened Cast Iron
VDI 3323	21	22	23	24	25	26	27	28	29	30	31	32	33	34	35	36	37	38	39	40	41
HRc											15	30	25	38	34			55	60	42	55
HB	60	100	75	90	130	110	90	100			200	280	250	350	320	400 Rm	1050 Rm	550	630	400	550
Recommend	◎	◎	◎	◎	○	○	○	○	○	○											

CARBIDE, 3 FLUTE 37° HELIX CORNER RADIUS with EXTENDED NECK

- Vollhartmetall, 3 Schneiden 37° Eckradius mit verlängertem Hals
- Fraise carbure, 3 dents, torique, hélice 37°, détalonnée, extra-courte
- 3 TAGLIANTI, ELICA 37°, SPIGOLO RAGGIATO SCARICATA

- ▶ Balanced cutting with less vibration
- ▶ Ability to run at higher speeds with less heat in aluminum
- ▶ More efficient chip evacuation
- ▶ Ability to counteract extreme radial forces
- ▶ DLC Coating provides edge strength and unsurpassed tool life

- ▶ Ausgewogenes Fräsen, mit weniger Vibrationen
- ▶ Höhere Schnittgeschwindigkeiten möglich bei weniger Wärmeeinbringung in den Werkstoff Aluminium
- ▶ Effizientere Spanabfuhr
- ▶ Fähigkeit, extremen Radialkräften entgegenzuwirken
- ▶ Die DLC-Beschichtung bietet Kantenfestigkeit und unübertroffene Standzeit

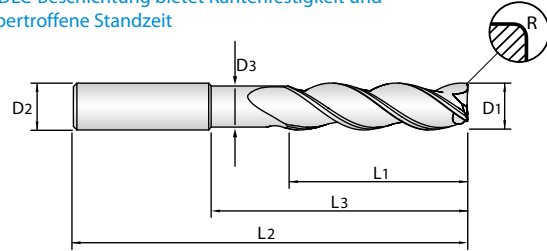
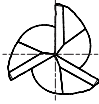

P.474

Unit : mm

EDP No.		Corner Radius	Mill Diameter	Shank Diameter	Length of Cut	Length Below Shank	Overall Length	Neck Diameter
Uncoated	DLC	R	D1	D2	L1	L3	L2	D3
E5H25060	JAH25060	R0.5	6.0	6	10	20	63	5.7
E5H25901	JAH25901	R1.0	6.0	6	10	20	63	5.7
E5H25902	JAH25902	R0.5	6.0	6	13	30	72	5.7
E5H25903	JAH25903	R1.0	6.0	6	13	30	72	5.7
E5H25080	JAH25080	R0.3	8.0	8	12	25	75	7.4
E5H25904	JAH25904	R0.5	8.0	8	12	25	75	7.4
E5H25905	JAH25905	R0.8	8.0	8	12	25	75	7.4
E5H25906	JAH25906	R1.0	8.0	8	12	25	75	7.4
E5H25907	JAH25907	R1.2	8.0	8	12	25	75	7.4
E5H25908	JAH25908	R1.5	8.0	8	12	25	75	7.4
E5H25909	JAH25909	R1.6	8.0	8	12	25	75	7.4
E5H25100	JAH25100	R0.3	10.0	10	14	35	100	9.2
E5H25910	JAH25910	R0.5	10.0	10	14	35	100	9.2
E5H25911	JAH25911	R0.8	10.0	10	14	35	100	9.2
E5H25912	JAH25912	R1.0	10.0	10	14	35	100	9.2
E5H25913	JAH25913	R1.2	10.0	10	14	35	100	9.2
E5H25914	JAH25914	R1.5	10.0	10	14	35	100	9.2
E5H25915	JAH25915	R1.6	10.0	10	14	35	100	9.2

▶ NEXT PAGE

Mill Diameter Tolerances (mm)		Shank Diameter Tolerance
Diameter	Tolerance	
Up to 3	+0/-0.006	h5
Over 3 ~ up to 6	+0/-0.008	
Over 6 ~ up to 10	+0/-0.009	
Over 10 ~ up to 18	+0/-0.011	
Over 18 ~ up to 25	+0/-0.013	

◎ : Excellent ○ : Good

ISO Material Description	P											M				K								
	Non-alloy steel					Low alloy steel						High alloyed steel, and tool steel				Stainless steel				Grey cast iron		Nodular cast iron		Malleable cast iron
VDI 3323	1	2	3	4	5	6	7	8	9	10	11	12	13	14	15	16	17	18	19	20				
HRc		13	25	28	32	10	29	32	38	15	35	15	23	10	10	26	3	25	42	21				
HB	125	190	250	270	300	180	275	300	350	200	325	200	240	180	180	260	160	250	130	230				
Recommend																								

ISO Material Description	N					S					H										
	Aluminum-wrought alloy		Aluminum-cast, alloyed		Copper and Copper Alloys (Bronze / Brass)	Non Metallic Materials	Heat Resistant Super Alloys				Titanium Alloys		Hardened steel	Chilled Cast Iron	Hardened Cast Iron						
VDI 3323	21	22	23	24	25	26	27	28	29	30	31	32	33	34	35	36	37	38	39	40	41
HRc											15	30	25	38	34	55	60	55	60	42	55
HB	60	100	75	90	130	110	90	100			200	280	250	350	320	400 Rm	1050 Rm	550	630	400	550
Recommend	◎	◎	◎	◎	◎	◎	◎	◎	◎	◎											

CARBIDE, 3 FLUTE 37° HELIX CORNER RADIUS with EXTENDED NECK

- Vollhartmetall, 3 Schneiden 37° Eckradius mit verlängertem Hals
- Fraise carbure, 3 dents, torique, hélice 37°, détalonnée, extra-courte
- 3 TAGLIANTI, ELICA 37°, SPIGOLO RAGGIATO SCARICATA

- ▶ Balanced cutting with less vibration
- ▶ Ability to run at higher speeds with less heat in aluminum
- ▶ More efficient chip evacuation
- ▶ Ability to counteract extreme radial forces
- ▶ DLC Coating provides edge strength and unsurpassed tool life

- ▶ Ausgewogenes Fräsen, mit weniger Vibrationen
- ▶ Höhere Schnittgeschwindigkeiten möglich bei weniger Wärmeinbringung in den Werkstoff Aluminium
- ▶ Effizientere Spanabfuhr
- ▶ Fähigkeit, extremen Radialkräften entgegenzuwirken
- ▶ Die DLC-Beschichtung bietet Kantenfestigkeit und unübertroffene Standzeit

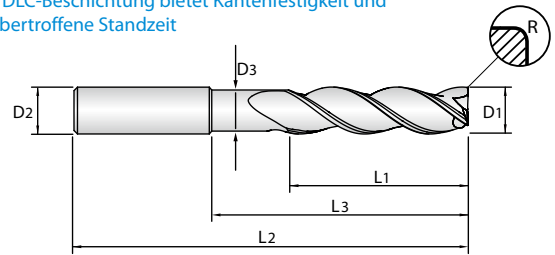
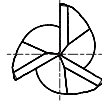

Unit : mm

EDP No.		Corner Radius	Mill Diameter	Shank Diameter	Length of Cut	Length Below Shank	Overall Length	Neck Diameter
Uncoated	DLC	R	D1	D2	L1	L3	L2	D3
E5H25916	JAH25916	R2.4	10.0	10	14	35	100	9.2
E5H25120	JAH25120	R0.5	12.0	12	16	40	100	11.0
E5H25917	JAH25917	R0.8	12.0	12	16	40	100	11.0
E5H25918	JAH25918	R1.0	12.0	12	16	40	100	11.0
E5H25919	JAH25919	R1.2	12.0	12	16	40	100	11.0
E5H25920	JAH25920	R1.5	12.0	12	16	40	100	11.0
E5H25921	JAH25921	R1.6	12.0	12	16	40	100	11.0
E5H25922	JAH25922	R2.0	12.0	12	16	40	100	11.0
E5H25923	JAH25923	R2.4	12.0	12	16	40	100	11.0
E5H25924	JAH25924	R2.5	12.0	12	16	40	100	11.0
E5H25925	JAH25925	R3.0	12.0	12	16	40	100	11.0
E5H25926	JAH25926	R4.0	12.0	12	16	40	100	11.0
E5H25140	JAH25140	R1.0	14.0	14	18	45	125	13.0
E5H25927	JAH25927	R2.0	14.0	14	18	45	125	13.0
E5H25928	JAH25928	R3.0	14.0	14	18	45	125	13.0
E5H25929	JAH25929	R4.0	14.0	14	18	45	125	13.0
E5H25160	JAH25160	R0.8	16.0	16	20	50	125	15.0
E5H25930	JAH25930	R1.2	16.0	16	20	50	125	15.0

▶ NEXT PAGE

Mill Diameter Tolerances (mm)		Shank Diameter Tolerance
Diameter	Tolerance	
Up to 3	+0/-0.006	h5
Over 3 ~ up to 6	+0/-0.008	
Over 6 ~ up to 10	+0/-0.009	
Over 10 ~ up to 18	+0/-0.011	
Over 18 ~ up to 25	+0/-0.013	

◎ : Excellent ○ : Good

ISO Material Description	P									M				K								
	Non-alloy steel					Low alloy steel				High alloyed steel, and tool steel				Stainless steel				Grey cast iron		Nodular cast iron		Malleable cast iron
VDI 3323	1	2	3	4	5	6	7	8	9	10	11	12	13	14	15	16	17	18	19	20		
HRc		13	25	28	32	10	29	32	38	15	35	15	23	10	10	26	3	25	42	21		
HB	125	190	250	270	300	180	275	300	350	200	325	200	240	180	180	260	160	250	130	230		
Recommend																						
ISO Material Description	N					S					H											
	Aluminum-wrought alloy		Aluminum-cast, alloyed			Copper and Copper Alloys (Bronze / Brass)		Non Metallic Materials			Heat Resistant Super Alloys					Titanium Alloys		Hardened steel		Chilled Cast Iron	Hardened Cast Iron	
VDI 3323	21	22	23	24	25	26	27	28	29	30	31	32	33	34	35	36	37	38	39	40	41	
HRc											15	30	25	38	34	36	37	55	60	42	55	
HB	60	100	75	90	130	110	90	100			200	280	250	350	320	400 Rm	1050 Rm	550	630	400	550	
Recommend	◎	◎	◎	◎	○	○	○	○	○	○												

CARBIDE, 3 FLUTE 37° HELIX CORNER RADIUS with EXTENDED NECK

- Vollhartmetall, 3 Schneiden 37° Eckradius mit verlängertem Hals
- Fraise carbure, 3 dents, torique, hélice 37°, détalonnée, extra-courte
- 3 TAGLIANTI, ELICA 37°, SPIGOLO RAGGIATO SCARICATA

- ▶ Balanced cutting with less vibration
- ▶ Ability to run at higher speeds with less heat in aluminum
- ▶ More efficient chip evacuation
- ▶ Ability to counteract extreme radial forces
- ▶ DLC Coating provides edge strength and unsurpassed tool life

- ▶ Ausgewogenes Fräsen, mit weniger Vibrationen
- ▶ Höhere Schnittgeschwindigkeiten möglich bei weniger Wärmeeinbringung in den Werkstoff Aluminium
- ▶ Effizientere Spanabfuhr
- ▶ Fähigkeit, extremen Radialkräften entgegenzuwirken
- ▶ Die DLC-Beschichtung bietet Kantenfestigkeit und unübertroffene Standzeit

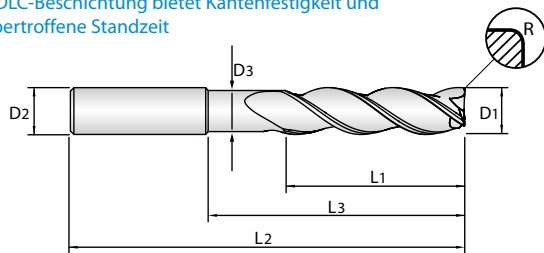
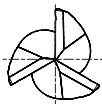

Unit : mm

EDP No.		Corner Radius	Mill Diameter	Shank Diameter	Length of Cut	Length Below Shank	Overall Length	Neck Diameter
Uncoated	DLC	R	D1	D2	L1	L3	L2	D3
E5H25931	JAH25931	R1.6	16.0	16	20	50	125	15.0
E5H25932	JAH25932	R2.0	16.0	16	20	50	125	15.0
E5H25933	JAH25933	R2.4	16.0	16	20	50	125	15.0
E5H25934	JAH25934	R2.5	16.0	16	20	50	125	15.0
E5H25935	JAH25935	R3.0	16.0	16	20	50	125	15.0
E5H25936	JAH25936	R3.2	16.0	16	20	50	125	15.0
E5H25937	JAH25937	R4.0	16.0	16	20	50	125	15.0
E5H25200	JAH25200	R0.8	20.0	20	25	65	150	19.0
E5H25938	JAH25938	R1.2	20.0	20	25	65	150	19.0
E5H25939	JAH25939	R1.6	20.0	20	25	65	150	19.0
E5H25940	JAH25940	R2.0	20.0	20	25	65	150	19.0
E5H25941	JAH25941	R2.4	20.0	20	25	65	150	19.0
E5H25942	JAH25942	R2.5	20.0	20	25	65	150	19.0
E5H25943	JAH25943	R3.0	20.0	20	25	65	150	19.0
E5H25944	JAH25944	R3.2	20.0	20	25	65	150	19.0
E5H25945	JAH25945	R4.0	20.0	20	25	65	150	19.0

Mill Diameter Tolerances (mm)		Shank Diameter Tolerance
Diameter	Tolerance	
Up to 3	+0/-0.006	h5
Over 3 ~ up to 6	+0/-0.008	
Over 6 ~ up to 10	+0/-0.009	
Over 10 ~ up to 18	+0/-0.011	
Over 18 ~ up to 25	+0/-0.013	

◎ : Excellent ○ : Good

ISO Material Description	P										M				K						
	Non-alloy steel					Low alloy steel					High alloyed steel, and tool steel				Stainless steel		Grey cast iron		Nodular cast iron		Malleable cast iron
VDI 3323	1	2	3	4	5	6	7	8	9	10	11	12	13	14	15	16	17	18	19	20	
HRc		13	25	28	32	10	29	32	38	15	35	15	23	10	10	26	3	25	42	21	
HB	125	190	250	270	300	180	275	300	350	200	325	200	240	180	180	260	160	250	130	230	
Recommend																					

ISO Material Description	N					S										H					
	Aluminum-wrought alloy		Aluminum-cast, alloyed			Copper and Copper Alloys (Bronze / Brass)			Non Metallic Materials		Heat Resistant Super Alloys					Titanium Alloys		Hardened steel	Chilled Cast Iron	Hardened Cast Iron	
VDI 3323	21	22	23	24	25	26	27	28	29	30	31	32	33	34	35	36	37	38	39	40	41
HRc											15	30	25	38	34			55	60	42	55
HB	60	100	75	90	130	110	90	100			200	280	250	350	320	400 Rm	1050 Rm	550	630	400	550
Recommend	◎	◎	◎	◎	○	○	○	○	○	○											

YG ALU-POWER HPC END MILLS

UNCOATED

E5H22 SERIES

DLC COATED

JAH22 SERIES

PLAIN SHANK

CARBIDE, 3 FLUTE 37° HELIX

- Vollhartmetall, 3 Schneiden 37°
- Fraise carbure, torique, hélice 37°
- 3 TAGLIANTI, ELICA 37°

- ▶ Balanced cutting with less vibration
- ▶ Ability to run at higher speeds with less heat in aluminum
- ▶ More efficient chip evacuation
- ▶ Ability to counteract extreme radial forces
- ▶ DLC Coating provides edge strength and unsurpassed tool life

- ▶ Ausgewogenes Fräsen, mit weniger Vibrationen
- ▶ Höhere Schnittgeschwindigkeiten möglich bei weniger Wärmeeinbringung in den Werkstoff Aluminium
- ▶ Effizientere Spanabfuhr
- ▶ Fähigkeit, extremen Radialkräften entgegenzuwirken
- ▶ Die DLC-Beschichtung bietet Kantenfestigkeit und unübertroffene Standzeit

UNCOATED



DLC COATED

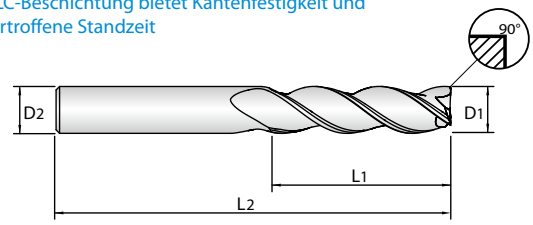
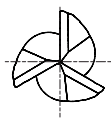

CARBIDE 3 37° PLAIN P.475

Unit : mm

EDP No.		Mill Diameter	Shank Diameter	Length of Cut	Overall Length
Uncoated	DLC	D1	D2	L1	L2
E5H22030	JAH22030	3.0	6	8	52
E5H22040	JAH22040	4.0	6	11	55
E5H22050	JAH22050	5.0	6	13	57
E5H22060	JAH22060	6.0	6	13	57
E5H22901	JAH22901	6.0	6	13	72
E5H22902	JAH22902	6.0	6	24	75
E5H22080	JAH22080	8.0	8	19	63
E5H22903	JAH22903	8.0	8	32	75
E5H22100	JAH22100	10.0	10	22	72
E5H22904	JAH22904	10.0	10	40	100
E5H22120	JAH22120	12.0	12	26	83
E5H22905	JAH22905	12.0	12	48	100
E5H22140	JAH22140	14.0	14	30	89
E5H22160	JAH22160	16.0	16	32	92
E5H22906	JAH22906	16.0	16	64	125
E5H22200	JAH22200	20.0	20	38	104
E5H22907	JAH22907	20.0	20	80	150
E5H22250	JAH22250	25.0	25	50	125

Mill Diameter Tolerances (mm)		Shank Diameter Tolerance
Diameter	Tolerance	
Up to 3	+0/-0.006	h5
Over 3 ~ up to 6	+0/-0.008	
Over 6 ~ up to 10	+0/-0.009	
Over 10 ~ up to 18	+0/-0.011	
Over 18 ~ up to 25	+0/-0.013	

◎ : Excellent ○ : Good

ISO Material Description	P										M				K															
	Non-alloy steel					Low alloy steel					High alloyed steel, and tool steel				Stainless steel				Grey cast iron		Nodular cast iron		Malleable cast iron							
VDI 3323	1	2	3	4	5	6	7	8	9	10	11	12	13	14	15	16	17	18	19	20	21	22	23	24	25	26	27	28	29	30
HRc		13	25	28	32	10	29	32	38	15	35	15	23	10	10	26	3	3	25	21										
HB	125	190	250	270	300	180	275	300	350	200	325	200	240	180	180	260	160	250	130	230										
Recommend																														

ISO Material Description	N										S							H												
	Aluminum-wrought alloy		Aluminum-cast, alloyed			Copper and Copper Alloys (Bronze / Brass)			Non Metallic Materials		Heat Resistant Super Alloys							Titanium Alloys		Hardened steel	Chilled Cast Iron	Hardened Cast Iron								
VDI 3323	21	22	23	24	25	26	27	28	29	30	31	32	33	34	35	36	37	38	39	40	41	42	43	44	45	46	47	48	49	50
HRc																														
HB	60	100	75	90	130	110	90	100			200	280	250	350	320	400 Rm	1050 Rm	550	630	400	550									
Recommend	◎	◎	◎	◎	◎	◎	◎	◎	◎	◎	◎	◎	◎	◎	◎	◎	◎	◎	◎	◎	◎	◎	◎	◎	◎	◎	◎	◎	◎	◎

CARBIDE, 3 FLUTE 37° HELIX with EXTENDED NECK

- Vollhartmetall, 3 Schneiden 37°
- Fraise carbure, 3 dents, hélice 37°, détalonnée, extra-courte
- 3 TAGLIANTI, ELICA 37°, SCARICATA

- ▶ Balanced cutting with less vibration
- ▶ Ability to run at higher speeds with less heat in aluminum
- ▶ More efficient chip evacuation
- ▶ Ability to counteract extreme radial forces
- ▶ DLC Coating provides edge strength and unsurpassed tool life

- ▶ Ausgewogenes Fräsen, mit weniger Vibrationen
- ▶ Höhere Schnittgeschwindigkeiten möglich bei weniger Wärmeeinbringung in den Werkstoff Aluminium
- ▶ Effizientere Spanabfuhr
- ▶ Fähigkeit, extremen Radialkräften entgegenzuwirken
- ▶ Die DLC-Beschichtung bietet Kantenfestigkeit und unübertroffene Standzeit

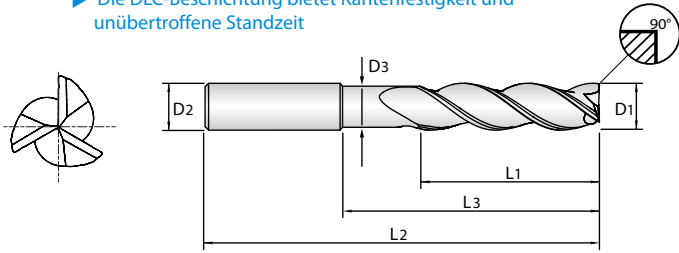

Unit : mm

EDP No.		Mill Diameter	Shank Diameter	Length of Cut	Length Below Shank	Overall Length	Neck Diameter
Uncoated	DLC	D1	D2	L1	L3	L2	D3
E5H23060	JAH23060	6.0	6	10	20	75	5.7
E5H23080	JAH23080	8.0	8	12	25	75	7.4
E5H23100	JAH23100	10.0	10	14	35	100	9.2
E5H23120	JAH23120	12.0	12	16	40	100	11.0
E5H23140	JAH23140	14.0	14	18	45	125	13.0
E5H23160	JAH23160	16.0	16	20	50	125	15.0
E5H23200	JAH23200	20.0	20	25	65	150	19.0

Mill Diameter Tolerances (mm)		Shank Diameter Tolerance
Diameter	Tolerance	
Up to 3	+0/-0.006	h5
Over 3 ~ up to 6	+0/-0.008	
Over 6 ~ up to 10	+0/-0.009	
Over 10 ~ up to 18	+0/-0.011	
Over 18 ~ up to 25	+0/-0.013	

◎ : Excellent ○ : Good

ISO Material Description	P										M				K								
	Non-alloy steel					Low alloy steel					High alloyed steel, and tool steel				Stainless steel				Grey cast iron		Nodular cast iron		Malleable cast iron
VDI 3323	1	2	3	4	5	6	7	8	9	10	11	12	13	14	15	16	17	18	19	20			
HRc	13	25	28	32	10	29	32	38	15	35	15	23	10	10	26	3	25	42	21				
HB	125	190	250	270	300	180	275	300	350	200	325	200	240	180	180	260	160	250	130	230			
Recommend																							
ISO Material Description	N					S					H												
	Aluminum-wrought alloy		Aluminum-cast, alloyed			Copper and Copper Alloys (Bronze / Brass)			Non Metallic Materials		Heat Resistant Super Alloys					Titanium Alloys		Hardened steel	Chilled Cast Iron	Hardened Cast Iron			
VDI 3323	21	22	23	24	25	26	27	28	29	30	31	32	33	34	35	36	37	38	39	40	41		
HRc	60	100	75	90	130	110	90	100			200	280	250	350	320	400 Rm	1050 Rm	550	630	400	550		
Recommend	◎	◎	◎	◎	◎	◎	◎	◎	◎	◎													

E5H24, JAH24, E5H25, JAH25 SERIES

Vc = m/min.
fz = mm/tooth
RPM = rev./min.
FEED = mm/min.

3 FLUTE CORNER RADIUS - SLOTTING

ISO	VDI 3323	Material Description	Ae	Ap	Parameter	6.0	10.0	12.0	16.0	20.0
						N	21~22	Aluminum-wrought alloy	1.0D	1.0D
fz	0.076	0.114	0.152	0.168	0.191					
RPM	25889	15533	12945	9708	7767					
23~25	Aluminum-cast, alloyed	1.0D	1.0D	Vc	183		183	183	183	183
				fz	0.076		0.114	0.152	0.168	0.191
				RPM	9708		5825	4854	3641	2913
26-28	Copper and Copper Alloys (Bronze / Brass)	1.0D	1.0D	Vc	268		268	268	268	268
				fz	0.051		0.102	0.127	0.140	0.152
				RPM	14218		8531	7109	5332	4265
29.1	Non Metallic Materials	1.0D	1.0D	Vc	503		503	503	503	503
				fz	0.102		0.191	0.254	0.279	0.305
				RPM	26685		16011	13342	10007	8005
					FEED	8134	9150	10167	8388	7320

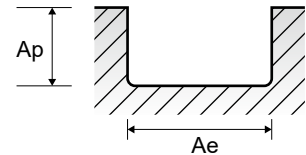

3 FLUTE CORNER RADIUS - SIDE CUTTING

ISO	VDI 3323	Material Description	Ae	Ap	Parameter	6.0	10.0	12.0	16.0	20.0
						N	21~22	Aluminum-wrought alloy	0.5D	1.5D
fz	0.076	0.114	0.152	0.168	0.191					
RPM	32361	19417	16181	12136	9708					
23~25	Aluminum-cast, alloyed	0.5D	1.5D	Vc	244		244	244	244	244
				fz	0.076		0.114	0.152	0.168	0.191
				RPM	12945		7767	6472	4854	3883
26-28	Copper and Copper Alloys (Bronze / Brass)	0.5D	1.5D	Vc	351		351	351	351	351
				fz	0.051		0.102	0.127	0.140	0.152
				RPM	18621		11173	9311	6983	5586
29.1	Non Metallic Materials	0.5D	1.5D	Vc	625		625	625	625	625
				fz	0.102		0.191	0.254	0.279	0.305
				RPM	33157		19894	16579	12434	9947
					FEED	10106	11370	12633	10422	9096

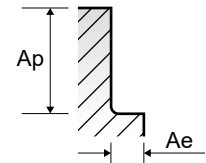

3 FLUTE CORNER RADIUS - SIDE CUTTING HSM (Light)

ISO	VDI 3323	Material Description	Ae	Ap	Parameter	6.0	10.0	12.0	16.0	20.0
						N	21~22	Aluminum-wrought alloy	0.05D	2.0D
fz	0.140	0.267	0.356	0.381	0.419					
RPM	53370	32022	26685	20014	16011					
23~25	Aluminum-cast, alloyed	0.05D	2.0D	Vc	366		366	366	366	366
				fz	0.140		0.267	0.356	0.381	0.419
				RPM	19417		11650	9708	7281	5825
26-28	Copper and Copper Alloys (Bronze / Brass)	0.05D	2.0D	Vc	564		564	564	564	564
				fz	0.114		0.216	0.292	0.330	0.356
				RPM	29921		17953	14961	11220	8976
29.1	Non Metallic Materials	0.05D	2.0D	Vc	1021		1021	1021	1021	1021
				fz	0.229		0.432	0.584	0.635	0.699
				RPM	54166		32499	27083	20312	16250
					FEED	37147	42100	47465	38695	34051

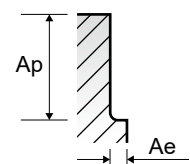

Vc = m/min.
fz = mm/tooth
RPM = rev./min.
FEED = mm/min.

E5H22, JAH22, E5H23, JAH23 SERIES

3 FLUTE - SLOTING

ISO	VDI 3323	Material Description	Ae	Ap	Parameter	Mill Diameter (Ø)						
						3.0	6.0	10.0	12.0	16.0	20.0	25.0
N	21~22	Aluminum-wrought alloy	1.0D	1.0D	Vc	488	488	488	488	488	488	488
					fz	0.025	0.076	0.114	0.152	0.168	0.191	0.254
					RPM	51778	25889	15533	12945	9708	7767	6213
					FEED	3946	5918	5326	5918	4883	4439	4735
	23~25	Aluminum-cast, alloyed	1.0D	1.0D	Vc	183	183	183	183	183	183	183
					fz	0.025	0.076	0.114	0.152	0.168	0.191	0.254
					RPM	19417	9708	5825	4854	3641	2913	2330
					FEED	1480	2219	1997	2219	1831	1665	1775
	26-28	Copper and Copper Alloys (Bronze / Brass)	1.0D	1.0D	Vc	268	268	268	268	268	268	268
					fz	0.020	0.051	0.102	0.127	0.140	0.152	0.178
					RPM	28436	14218	8531	7109	5332	4265	3412
					FEED	1733	2167	2600	2708	2235	1950	1820
29.1	Non Metallic Materials	1.0D	1.0D	Vc	503	503	503	503	503	503	503	
				fz	0.038	0.102	0.191	0.254	0.279	0.305	0.356	
				RPM	53370	26685	16011	13342	10007	8005	6404	
				FEED	6100	8134	9150	10167	8388	7320	6832	

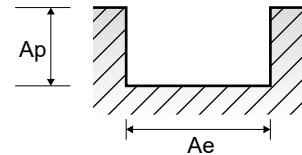

3 FLUTE - SIDE CUTTING

ISO	VDI 3323	Material Description	Ae	Ap	Parameter	Mill Diameter (Ø)						
						3.0	6.0	10.0	12.0	16.0	20.0	25.0
N	21~22	Aluminum-wrought alloy	0.5D	1.5D	Vc	610	610	610	610	610	610	610
					fz	0.025	0.076	0.114	0.152	0.168	0.191	0.254
					RPM	64723	32361	19417	16181	12136	9708	7767
					FEED	4932	7398	6658	7398	6103	5548	5918
	23~25	Aluminum-cast, alloyed	0.5D	1.5D	Vc	244	244	244	244	244	244	244
					fz	0.025	0.076	0.114	0.152	0.168	0.191	0.254
					RPM	25889	12945	7767	6472	4854	3883	3107
					FEED	1973	2959	2663	2959	2441	2219	2367
	26-28	Copper and Copper Alloys (Bronze / Brass)	0.5D	1.5D	Vc	351	351	351	351	351	351	351
					fz	0.020	0.051	0.102	0.127	0.140	0.152	0.178
					RPM	37242	18621	11173	9311	6983	5586	4469
					FEED	2270	2838	3405	3547	2927	2554	2384
29.1	Non Metallic Materials	0.5D	1.5D	Vc	625	625	625	625	625	625	625	
				fz	0.038	0.102	0.191	0.254	0.279	0.305	0.356	
				RPM	66314	33157	19894	16579	12434	9947	7958	
				FEED	7580	10106	11370	12633	10422	9096	8489	

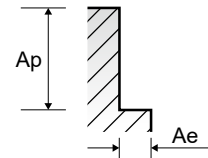

3 FLUTE - SIDE CUTTING HSM (Light)

ISO	VDI 3323	Material Description	Ae	Ap	Parameter	Mill Diameter (Ø)						
						3.0	6.0	10.0	12.0	16.0	20.0	25.0
N	21~22	Aluminum-wrought alloy	0.05D	2.0D	Vc	1006	1006	1006	1006	1006	1006	1006
					fz	0.053	0.140	0.267	0.356	0.381	0.419	0.495
					RPM	106740	53370	32022	26685	20014	16011	12809
					FEED	17080	22367	25621	28467	22876	20131	19033
	23~25	Aluminum-cast, alloyed	0.05D	2.0D	Vc	366	366	366	366	366	366	366
					fz	0.053	0.140	0.267	0.356	0.381	0.419	0.495
					RPM	38834	19417	11650	9708	7281	5825	4660
					FEED	6214	8138	9321	10357	8323	7324	6924
	26-28	Copper and Copper Alloys (Bronze / Brass)	0.05D	2.0D	Vc	564	564	564	564	564	564	564
					fz	0.043	0.114	0.216	0.292	0.330	0.356	0.406
					RPM	59842	29921	17953	14961	11220	8976	7181
					FEED	7752	10260	11628	13110	11115	9576	8755
29.1	Non Metallic Materials	0.05D	2.0D	Vc	1021	1021	1021	1021	1021	1021	1021	
				fz	0.086	0.229	0.432	0.584	0.635	0.699	0.813	
				RPM	108331	54166	32499	27083	20312	16250	13000	
				FEED	28066	37147	42100	47465	38695	34051	31699	

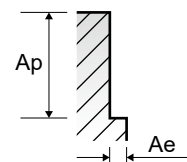



Global Cutting Tool Leader **YG-1**



MILLING



Leading Through Innovation



SOLID CARBIDE

ALU-POWER END MILLS

Alu - Power VHM/HSS-PM - Fräser

- For Aluminium Alloys and Silent Cutting
- Für Aluminiumlegierungen und geräuscharmen Schnitt

SELECTION GUIDE



SERIES	E5910	E5908	E5909
FLUTE	2	3	2
HELIX ANGLE	50°	40°	30°
CUTTING EDGE SHAPE	BALL NOSE	BALL NOSE	CORNER RADIUS
SIZE MIN	R3.0	R1.0	D4.0
SIZE MAX	R10.0	R8.0	D20.0
PAGE	480	481	482

SOLID CARBIDE
ALU POWER
END MILLS

Aluminium Alloys and Silent Cutting



Please visit globalyg1.com/mat for material search

◎ : Excellent ○ : Good

Recommended cutting conditions : P 494



ISO	VDI 3323	Material Description	Composition / Structure / Heat Treatment	HB	HRc			
P	1	Non-alloy steel	About 0.15% C Annealed	125				
	2		About 0.45% C Annealed	190	13			
	3		About 0.45% C Quenched & Tempered	250	25			
	4		About 0.75% C Annealed	270	28			
	5		About 0.75% C Quenched & Tempered	300	32			
	6	Low alloy steel	Annealed	180	10			
	7		Quenched & Tempered	275	29			
	8		Quenched & Tempered	300	32			
	9		Quenched & Tempered	350	38			
	10		High alloyed steel, and tool steel	Annealed	200	15		
	11	Quenched & Tempered		325	35			
M	12	Stainless steel	Ferritic / Martensitic Annealed	200	15			
	13		Martensitic Quenched & Tempered	240	23			
	14	Austenitic	180	10				
K	15	Grey cast iron	Pearlitic / ferritic	180	10			
	16		Pearlitic (Martensitic)	260	26			
	17	Nodular cast iron	Ferritic	160	3			
	18		Pearlitic	250	25			
	19		Ferritic	130				
20	Malleable cast iron	Pearlitic	230	21				
N	21	Aluminum-wrought alloy	Not Curable	60		◎	◎	◎
	22		Curable Hardened	100		◎	◎	◎
	23	Aluminum-cast, alloyed	≤ 12% Si, Not Curable	75		◎	◎	◎
	24		≤ 12% Si, Curable Hardened	90		◎	◎	◎
	25		> 12% Si, Not Curable	130		○	○	○
	26	Copper and Copper Alloys	Cutting Alloys, PB>1%	110		○	○	○
	27		CuZn, CuSnZn (Brass)	90		○	○	○
	28	(Bronze / Brass)	CuSn, lead-free copper and electrolytic copper	100		○	○	○
	29	Non Metallic Materials	Duroplastic, Fiber Reinforced Plastic					
	30		Rubber, Wood, etc.					
S	31	Heat Resistant Super Alloys	Fe Based Annealed	200	15			
	32		Cured	280	30			
	33		Annealed	250	25			
	34		Ni or Co Based Cured	350	38			
	35		Cast	320	34			
	36	Titanium Alloys	Pure Titanium	400 Rm				
	37		Alpha + Beta Alloys Hardened	1050 Rm				
H	38	Hardened steel	Hardened	550	55			
	39		Hardened	630	60			
	40	Chilled Cast Iron	Cast	400	42			
	41	Hardened Cast Iron	Hardened	550	55			

E5930	E5E51	E5E47	E5E48	E5522 E5521	E5E49	E5E50	E5742 E5711	E5E39 E5E40	EP922 EP923	EP924 EP925
2	3	1	2	2	3	3	3	3	3	3
25°	45°	30°	45°	45°	45°	45°	30°	30°	42°	42°
CORNER RADIUS	CORNER RADIUS	SQUARE	SQUARE	SQUARE	SQUARE	SQUARE	ROUGHING	ROUGHING	ROUGHING	ROUGHING
D2.0	D3.0	D2.0	D3.0	D3.0	D3.0	D3.0	D6.0	D6.0	D12.0	D12.0
D20.0	D20.0	D12.0	D20.0	D20.0	D20.0	D20.0	D25.0	D20.0	D28.0	D32.0
483	484	485	486	487	488	489	490	491	492	493
NECK	LONG LENGTH	-	SHORT LENGTH	LONG LENGTH	LONG LENGTH	NECK	LONG LENGTH	NECK	SHORT LENGTH	LONG LENGTH
Uncoated	Uncoated	Uncoated	Uncoated	Uncoated	Uncoated	Uncoated	Uncoated	Uncoated	TiAIN	TiAIN



							○	○			1
							○	○			2
							○	○			3
							○	○			4
											5
							○	○			6 P
							○	○			7
											8
											9
							○	○			10
											11
											12
											13 M
											14
							○	○	○	○	15
							○	○	○	○	16
							○	○	○	○	17 K
							○	○	○	○	18
							○	○	○	○	19
							○	○	○	○	20
◎	◎	◎	◎	◎	◎	◎	◎	◎	◎	◎	21
◎	◎	◎	◎	◎	◎	◎	◎	◎	◎	◎	22
◎	◎	◎	◎	◎	◎	◎	◎	◎	◎	◎	23
◎	◎	◎	◎	◎	◎	◎	◎	◎	◎	◎	24
○	○	○	○	○	○	○	○	○	○	○	25 N
											26
											27
											28
		◎									29
											30
											31
											32
											33
											34 S
											35
											36
											37
											38
											39 H
											40
											41

HSS

CBN
END MILLS

i-Xmill
END MILLS

i-SMART
MODULARTYPE
END MILLS

X5070
END MILLS

4G MILL
END MILLS

X-POWER
PRO
END MILLS

TitaNox-
POWER
END MILLS

JET-POWER
END MILLS

V7 PLUS
END MILLS

ALU-POWER
HPC
END MILLS

ALU-
POWER
END MILLS

D-POWER
GRAPHITE
END MILLS

D-POWER
CFRP
END MILLS

ROUTERS

CRX S
END MILLS

K-2
END MILLS

ONLY ONE
COATED PM60
END MILLS

TANK-
POWER
END MILLS

GENERAL
HSS
END MILLS

MILLING
CUTTER

TECHNICAL
DATA

CARBIDE, 2 FLUTE 50° HELIX BALL NOSE with NECK

● **VOLLHARTMETALL, 2 SCHNEIDEN 50° RECHTSSPIRALE STIRNRADIUS mit ABGESETZTEM SCHAFTTETEL**
● **Fraise carbure, 2 dents, hémisphérique, hélice 50°, détalonnée**
● **2 TAGLIENTI, ELICA 50°, SEMISFERICA, SCARICATA**

- ▶ Excellent cutting qualities on aluminum and copper
- ▶ Increased tool life and higher cutting accuracy
- ▶ Mirror surface - Excellent surface finish

- ▶ Ausgezeichnete Schneideigenschaften in Aluminium, Kupfer
- ▶ Verbesserte Standzeiten und höhere Fräsgenauigkeit.
- ▶ Spiegel-Oberfläche - Hervorragendes Oberflächenfinishing.

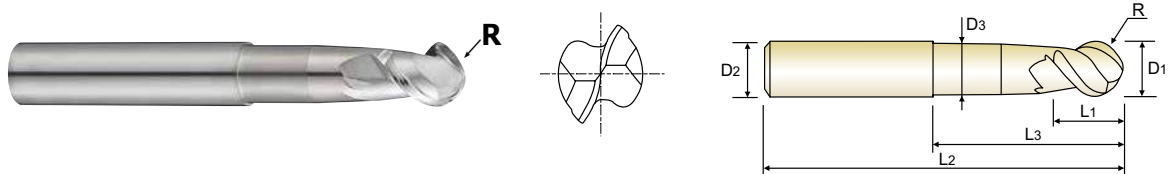

Unit : mm

EDP No.	Radius of Ball Nose	Mill Diameter	Shank Diameter	Length of Cut	Length Below Shank	Overall Length	Neck Diameter
	R(±0.02)	D1	D2	L1	L3	L2	D3
E5910060	R3.0	6.0	6	5.5	25	55	5.4
E5910080	R4.0	8.0	8	7	30	65	7.2
E5910100	R5.0	10.0	10	8.5	35	75	9
E5910120	R6.0	12.0	12	10.5	40	75	11
E5910160	R8.0	16.0	16	14	50	90	14.5
E5910200	R10.0	20.0	20	17	50	100	18

▶ TIN, TiCN and TiAlN Coatings are available on your request.

Mill Dia. Tolerance(mm)	Shank Dia. Tolerance
± 0.02	h5

◎ : Excellent ○ : Good

ISO Material Description	P											M				K								
	Non-alloy steel					Low alloy steel						High alloyed steel, and tool steel				Stainless steel				Grey cast iron		Nodular cast iron		Malleable cast iron
VDI 3323	1	2	3	4	5	6	7	8	9	10	11	12	13	14	15	16	17	18	19	20				
HRc	13	25	28	32	10	29	32	38	15	35	15	23	10	10	26	3	25	42	21					
HB	125	190	250	270	300	180	275	300	350	200	325	200	240	180	180	260	160	250	130	230				
Recommend																								
ISO Material Description	N										S							H						
	Aluminum-wrought alloy		Aluminum-cast, alloyed			Copper and Copper Alloys (Bronze / Brass)			Non Metallic Materials		Heat Resistant Super Alloys							Titanium Alloys		Hardened steel	Chilled Cast Iron	Hardened Cast Iron		
VDI 3323	21	22	23	24	25	26	27	28	29	30	31	32	33	34	35	36	37	38	39	40	41			
HRc											15	30	25	38	34			55	60	42	55			
HB	60	100	75	90	130	110	90	100			200	280	250	350	320	400 Rm	1050 Rm	550	630	400	550			
Recommend	◎	◎	◎	◎	○	○	○	○																

CARBIDE, 3 FLUTE 40° HELIX BALL NOSE with NECK

- VOLLHARTMETALL, 3 SCHNEIDEN 40° RECHTSSPIRALE STIRNRADIUS mit ABGESETZTEM SCHAFTTETL
- Fraise carbure, 3 dents, hémisphérique, hélice 40°, détalonnée
- 3 TAGLIANTI, ELICA 40°, SEMISFERICA, SCARICATA

- ▶ Excellent cutting qualities on aluminum and copper
- ▶ Increased tool life and higher cutting accuracy
- ▶ Mirror surface - Excellent surface finish

- ▶ Ausgezeichnete Schneideigenschaften in Aluminium, Kupfer
- ▶ Verbesserte Standzeiten und höhere Fräsgenauigkeit.
- ▶ Spiegel-Oberfläche - Hervorragendes Oberflächenfinishing.

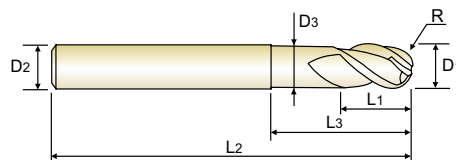
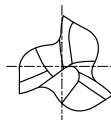

CARBIDE
3
40°
R ±0.02
PLAIN
P.494

Unit : mm

EDP No.	Radius of Ball Nose	Mill Diameter	Shank Diameter	Length of Cut	Length Below Shank	Overall Length	Neck Diameter
	R(±0.02)	D1	D2	L1	L3	L2	D3
E5908020	R1.0	2.0	6	3	5	60	1.9
E5908025	R1.25	2.5	6	4	6	60	2.4
E5908030	R1.5	3.0	6	4.5	6.5	60	2.8
E5908035	R1.75	3.5	6	5	7	65	3.2
E5908040	R2.0	4.0	6	6	8	65	3.7
E5908050	R2.5	5.0	6	7.5	10	65	4.6
E5908060	R3.0	6.0	6	9	12	75	5.6
E5908080	R4.0	8.0	8	12	25	75	7.4
E5908100	R5.0	10.0	10	15	30	80	9.4
E5908120	R6.0	12.0	12	18	36	90	11.4
E5908160	R8.0	16.0	16	24	40	100	15.4

▶ TiN, TiCN and TiAlN Coatings are available on your request.

Mill Dia. Tolerance(mm)	Shank Dia. Tolerance
0 ~ - 0.03	h5

◎ : Excellent ○ : Good

ISO Material Description	P										M				K								
	Non-alloy steel					Low alloy steel					High alloyed steel, and tool steel				Stainless steel				Grey cast iron		Nodular cast iron		Malleable cast iron
VDI 3323	1	2	3	4	5	6	7	8	9	10	11	12	13	14	15	16	17	18	19	20			
HRC	13	13	25	28	32	10	29	32	38	15	35	15	23	10	10	26	3	25	42	21			
HB	125	190	250	270	300	180	275	300	350	200	325	200	240	180	180	260	160	250	130	230			
Recommend																							
ISO Material Description	N										S						H						
	Aluminum-wrought alloy		Aluminum-cast, alloyed			Copper and Copper Alloys (Bronze / Brass)			Non Metallic Materials		Heat Resistant Super Alloys						Titanium Alloys		Hardened steel	Chilled Cast Iron	Hardened Cast Iron		
VDI 3323	21	22	23	24	25	26	27	28	29	30	31	32	33	34	35	36	37	38	39	40	41		
HRC	60	100	75	90	130	110	90	100			15	30	25	38	34			55	60	42	55		
HB	60	100	75	90	130	110	90	100			200	280	250	350	320	400 Rm	1050 Rm	550	630	400	550		
Recommend	◎	◎	◎	◎	◎	◎	◎	◎															

CARBIDE, 2 FLUTE CORNER RADIUS with NECK

- **VOLLHARTMETALL, 2 SCHNEIDEN ECKENRADIUS mit ABGESETZTEM SCHAFTTETL**
- **Fraise carbure, 2 dents, torique, détalonnée**
- **2 TAGLIENTI, TORICA, SCARICATA**

- ▶ Excellent cutting qualities on aluminum and copper
- ▶ Increased tool life and higher cutting accuracy
- ▶ Mirror surface - Excellent surface finish
- ▶ Superior chip evacuation
- ▶ Reduces chipping of corner edges

- ▶ Ausgezeichnete Schneideigenschaften in Aluminium, Kupfer
- ▶ Verbesserte Standzeiten und höhere Fräsgenauigkeit.
- ▶ Spiegel-Oberfläche - Hervorragendes Oberflächenfinishing.
- ▶ Überlegene Spanabfuhr
- ▶ Reduzierung von Schneideckenausbrüchen.

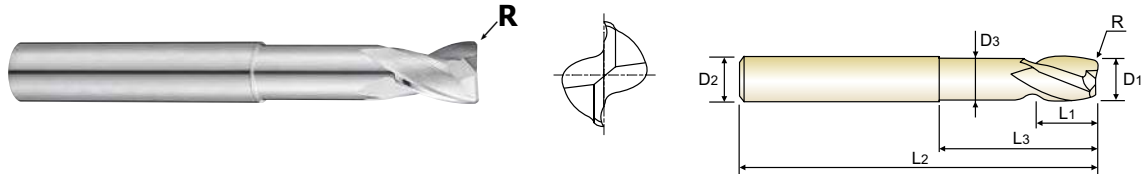

Unit : mm

EDP No.	Corner Radius	Mill Diameter	Shank Diameter	Length of Cut	Length Below Shank	Overall Length	Neck Diameter
	R(±0.01)	D1	D2	L1	L3	L2	D3
E5909040	R0.3	4.0	6.0	5	10	50	3.6
E5909060	R0.5	6.0	6.0	8	20	60	5.4
E5909080	R0.6	8.0	8.0	10	30	70	7.2
E5909100	R0.8	10.0	10.0	12	36	80	9
E5909120	R1.0	12.0	12.0	14	40	90	11
E5909160	R1.3	16.0	16.0	18	45	100	14.5
E5909200	R1.6	20.0	20.0	24	45	100	18

▶ TiN, TiCN and TiAlN Coatings are available on your request.

Mill Dia. Tolerance(mm)	Shank Dia. Tolerance
0 ~ - 0.03	h5

◎ : Excellent ○ : Good

ISO Material Description	P											M				K								
	Non-alloy steel					Low alloy steel						High alloyed steel, and tool steel				Stainless steel				Grey cast iron		Nodular cast iron		Malleable cast iron
VDI 3323	1	2	3	4	5	6	7	8	9	10	11	12	13	14	15	16	17	18	19	20				
HRc	13	25	28	32	30	10	29	32	38	15	35	15	23	10	10	26	3	25	42	21				
HB	125	190	250	270	300	180	275	300	350	200	325	200	240	180	180	260	160	250	130	230				
Recommend																								
ISO Material Description	N										S							H						
	Aluminum-wrought alloy		Aluminum-cast, alloyed			Copper and Copper Alloys (Bronze / Brass)			Non Metallic Materials		Heat Resistant Super Alloys							Titanium Alloys		Hardened steel	Chilled Cast Iron	Hardened Cast Iron		
VDI 3323	21	22	23	24	25	26	27	28	29	30	31	32	33	34	35	36	37	38	39	40	41			
HRc	60	100	75	90	130	110	90	100			15	30	25	38	34			55	60	42	55			
HB	60	100	75	90	130	110	90	100			200	280	250	350	320	400 Rm	1050 Rm	550	630	400	550			
Recommend	◎	◎	◎	◎	◎	○	○	○	○															

CARBIDE, 2 FLUTE 25° HELIX CORNER RADIUS with NECK

● VOLLHARTMETALL, 2 SCHNEIDEN 25° RECHTSSPIRALE ECKENRADIUS mit ABGESETZTEM SCHAFTTETL
 () Fraise carbure, 2 dents, torique, hélice 25°, détalonnée
 () 2 TAGLIANTI, ELICA 25°, TORICA, SCARICATA

- ▶ Designed for machining aluminum, aluminum alloys and non-ferrous material
- ▶ Mirror surface - Excellent surface finish
- ▶ Increased tool life and higher cutting accuracy
- ▶ Maximum-metal removal rate
- ▶ Superior chip evacuation
- ▶ Corner Radius to avoid chipping problems

- ▶ Entwickelt für die Bearbeitung von Aluminium, Aluminiumlegierungen, NE-Metalle
- ▶ Spiegel-Oberfläche - Hervorragendes Oberflächenfinishing.
- ▶ Verbesserte Standzeiten und höhere Fräsgenauigkeit.
- ▶ Maximale Zerspanungsleistung.
- ▶ Überlegene Spanabfuhr
- ▶ Eckradien verhindern Schneidkantenausbrüche

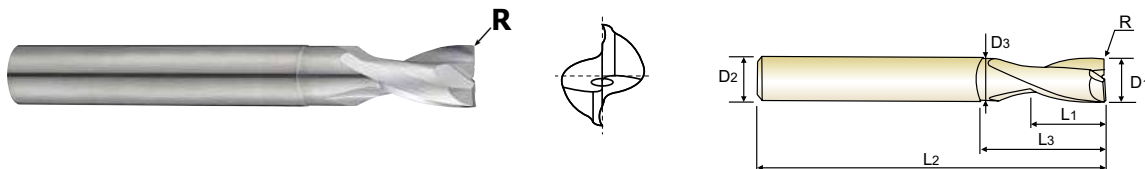

Unit : mm

EDP No.	Corner Radius	Mill Diameter	Shank Diameter	Length of Cut	Length Below Shank	Overall Length	Neck Diameter
	R(±0.01)	D1	D2	L1	L3	L2	D3
E5930020	R0.2	2.0	3	3	6	40	1.9
E5930030	R0.2	3.0	3	4	8	40	2.9
E5930040	R0.2	4.0	4	5	12	50	3.8
E5930050	R0.2	5.0	5	8	14	50	4.8
E5930060	R0.2	6.0	6	8	18	65	5.7
E5930080	R0.2	8.0	8	10	22	70	7.7
E5930100	R0.2	10.0	10	14	28	80	9.7
E5930120	R0.2	12.0	12	16	35	90	11.5
E5930160	R0.2	16.0	16	20	40	90	15.5
E5930200	R0.2	20.0	20	25	50	100	19.5

▶ TiN, TiCN and TiAlN Coatings are available on your request.

Mill Dia. Tolerance(mm)	Shank Dia. Tolerance
0 ~ - 0.03	h5

ISO Material Description	P										M				K									
	Non-alloy steel					Low alloy steel					High alloyed steel, and tool steel				Stainless steel				Grey cast iron	Nodular cast iron		Malleable cast iron		
VDI 3323	1	2	3	4	5	6	7	8	9	10	11	12	13	14	15	16	17	18	19	20	21	22	23	24
HRC	125	13	25	28	32	10	29	32	38	15	35	15	23	10	10	26	3	25	25	21	130	230		
HB	125	190	250	270	300	180	275	300	350	200	325	200	240	180	180	260	160	250	130	230				
Recommend																								
ISO Material Description	N										S						H							
	Aluminum-wrought alloy		Aluminum-cast, alloyed			Copper and Copper Alloys (Bronze / Brass)			Non Metallic Materials		Heat Resistant Super Alloys						Titanium Alloys		Hardened steel	Chilled Cast Iron	Hardened Cast Iron			
VDI 3323	21	22	23	24	25	26	27	28	29	30	31	32	33	34	35	36	37	38	39	40	41			
HRC	60	100	75	90	130	110	90	100			15	30	25	38	34	400 Rm	1050 Rm	550	600	42	55			
HB	60	100	75	90	130	110	90	100			200	280	250	350	320	400 Rm	1050 Rm	550	630	400	550			
Recommend	◎	◎	◎	◎	◎																			

◎ : Excellent ○ : Good

CARBIDE, 3 FLUTE 45° HELIX LONG LENGTH CORNER RADIUS

● **VOLLHARTMETALL, 3 SCHNEIDEN 45° RECHTSSPIRALE LANG ECKENRADIUS**
 ○ **Fraise carbure, 3 dents, torique, hélice 45°, longue**
 ○ **3 TAGLIENTI, ELICA 45°, TORICA, SERIE LUNGA**

- ▶ Excellent cutting qualities on aluminum and copper
- ▶ Increased tool life and higher cutting accuracy
- ▶ Mirror surface - Excellent surface finish
- ▶ Superior chip evacuation
- ▶ Reduces chipping of corner edges

- ▶ Ausgezeichnete Schneideigenschaften in Aluminium, Kupfer
- ▶ Verbesserte Standzeiten und höhere Fräsgenauigkeit.
- ▶ Spiegel-Oberfläche - Hervorragendes Oberflächenfinishing.
- ▶ Überlegene Spanabfuhr
- ▶ Reduzierung von Schneideckenausbrüchen.

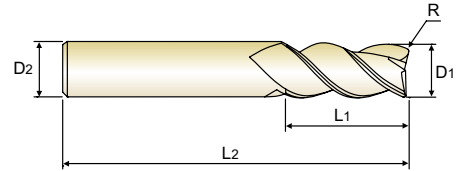
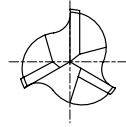

Unit : mm

EDP No.	Corner Radius	Mill Diameter	Shank Diameter	Length of Cut	Overall Length
	R	D1	D2	L1	L2
E5E51030	R0.5	3.0	6	12	57
E5E51901	R1.0	3.0	6	12	57
E5E51040	R0.5	4.0	6	15	57
E5E51902	R1.0	4.0	6	15	57
E5E51050	R0.5	5.0	6	20	57
E5E51903	R1.0	5.0	6	20	57
E5E51060	R0.5	6.0	6	20	65
E5E51904	R1.0	6.0	6	20	65
E5E51080	R0.5	8.0	8	22	65
E5E51905	R1.0	8.0	8	22	65
E5E51100	R0.5	10.0	10	25	70
E5E51906	R1.0	10.0	10	25	70
E5E51907	R2.0	10.0	10	25	70
E5E51120	R0.5	12.0	12	25	75
E5E51908	R1.0	12.0	12	25	75
E5E51909	R2.0	12.0	12	25	75
E5E51160	R0.5	16.0	16	35	90
E5E51910	R1.0	16.0	16	35	90
E5E51911	R2.0	16.0	16	35	90
E5E51200	R0.5	20.0	20	40	100
E5E51912	R1.0	20.0	20	40	100
E5E51913	R2.0	20.0	20	40	100

▶ TiN, TiCN and TiAlN Coatings are available on your request.

Mill Dia. Tolerance(mm)	Shank Dia. Tolerance
0 ~ -0.015	h5

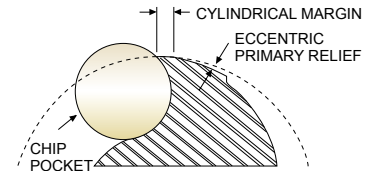

◎ : Excellent ○ : Good

ISO Material Description	P										M				K							
	Non-alloy steel					Low alloy steel					High alloyed steel, and tool steel				Stainless steel				Grey cast iron		Nodular cast iron	
VDI 3323	1	2	3	4	5	6	7	8	9	10	11	12	13	14	15	16	17	18	19	20		
HRc	13	25	28	32	10	29	32	38	15	35	15	23	10	10	26	3	25		21			
HB	125	190	250	270	300	180	275	300	350	200	325	200	240	180	180	260	160	250	130	230		
Recommend																						
ISO Material Description	N										S							H				
	Aluminum-wrought alloy		Aluminum-cast, alloyed			Copper and Copper Alloys (Bronze / Brass)			Non Metallic Materials		Heat Resistant Super Alloys					Titanium Alloys		Hardened steel	Chilled Cast Iron	Hardened Cast Iron		
VDI 3323	21	22	23	24	25	26	27	28	29	30	31	32	33	34	35	36	37	38	39	40	41	
HRc											15	30	25	38	34			55	60	42	55	
HB	60	100	75	90	130	110	90	100			200	280	250	350	320	400 Rm	1050 Rm	550	630	400	550	
Recommend	◎	◎	◎	◎	○																	

CARBIDE, 1 FLUTE

- VOLLHARTMETALL, 1 SCHNEIDEN
- Fraise carbure, 1 dent
- 1 TAGLIENTE

- ▶ Designed for non-ferrous material, non-metal like aluminum and acrylic
- ▶ 1 Flute allows excellent finished workpiece and chip evacuation

- ▶ Entwickelt für NE-Metalle und nichtmetallische Werkstoffe wie Aluminium und Acryl
- ▶ 1 Spannute ermöglicht hervorragende Werkstückoberflächen und Spanabfuhr

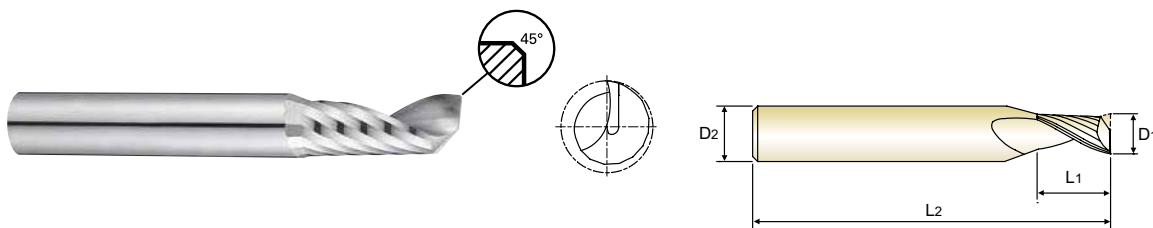

Unit : mm

EDP No.	Mill Diameter	Shank Diameter	Length of Cut	Overall Length	Chamfer
	D1	D2	L1	L2	
E5E47020	2.0	3	8	50	0.04
E5E47030	3.0	3	12	50	0.05
E5E47040	4.0	4	15	60	0.07
E5E47050	5.0	5	17	60	0.09
E5E47060	6.0	6	20	65	0.10
E5E47080	8.0	8	22	65	0.14
E5E47100	10.0	10	25	75	0.14
E5E47120	12.0	12	30	80	0.14

▶ TiN, TiCN and TiAlN Coatings are available on your request.

Mill Dia. Tolerance(mm)	Shank Dia. Tolerance
0 ~ -0.03	h5

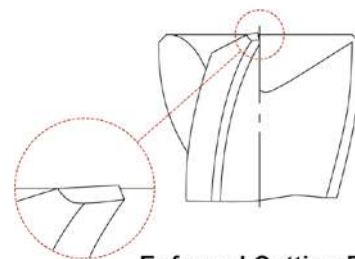

Enforced Cutting Edge

◎ : Excellent ○ : Good

ISO Material Description	P										M				K								
	Non-alloy steel					Low alloy steel					High alloyed steel, and tool steel				Stainless steel				Grey cast iron		Nodular cast iron		Malleable cast iron
VDI 3323	1	2	3	4	5	6	7	8	9	10	11	12	13	14	15	16	17	18	19	20			
HRc	13	25	28	32	10	29	32	38	15	35	15	23	10	10	26	3	25	25	21				
HB	125	190	250	270	300	180	275	300	350	200	325	200	240	180	180	260	160	250	130	230			
Recommend																							
ISO Material Description	N					S					H												
	Aluminum-wrought alloy		Aluminum-cast, alloyed			Copper and Copper Alloys (Bronze / Brass)			Non Metallic Materials		Heat Resistant Super Alloys					Titanium Alloys		Hardened steel	Chilled Cast Iron	Hardened Cast Iron			
VDI 3323	21	22	23	24	25	26	27	28	29	30	31	32	33	34	35	36	37	38	39	40	41		
HRc	60	100	75	90	130	110	90	100			15	30	25	38	34	55	60	55	60	42	55		
HB	60	100	75	90	130	110	90	100			200	280	250	350	320	400 Rm	1050 Rm	550	630	400	550		
Recommend	◎	◎	◎	◎	◎				◎														

CARBIDE, 2 FLUTE 45° HELIX SHORT LENGTH

- **VOLLHARTMETALL, 2 SCHNEIDEN 45° RECHTSSPIRALE KURZ**
- **Fraise carbure, 2 dents, hélice 45°, courte**
- **2 TAGLIENTI, ELICA 45°, SERIE CORTA**

- ▶ Suitable for high speed machining in aluminum and other non-ferrous materials
- ▶ Mirror surface - Excellent surface finish
- ▶ Superior chip evacuation

- ▶ Zur HSC-Bearbeitung von Aluminium und anderen Nichteisenmetallen.
- ▶ Spiegel-Oberfläche - Hervorragendes Oberflächenfinishing.
- ▶ Überlegene Spanabfuhr

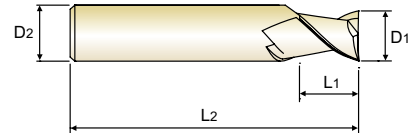
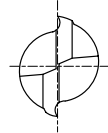

Unit : mm

EDP No.	Mill Diameter	Shank Diameter	Length of Cut	Overall Length
	D1	D2	L1	L2
E5E48030	3.0	6	5	50
E5E48040	4.0	6	8	54
E5E48050	5.0	6	9	54
E5E48060	6.0	6	10	54
E5E48080	8.0	8	12	58
E5E48100	10.0	10	14	66
E5E48120	12.0	12	16	73
E5E48140	14.0	14	18	75
E5E48160	16.0	16	22	82
E5E48180	18.0	18	24	84
E5E48200	20.0	20	26	92

▶ TiN, TiCN and TiAlN Coatings are available on your request.

Mill Dia. Tolerance(mm)	Shank Dia. Tolerance
0 ~ -0.015	h5

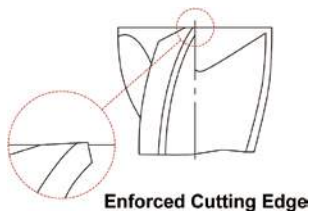
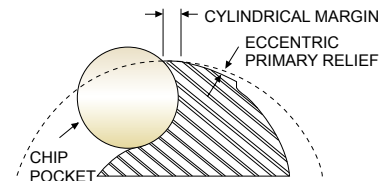

◎ : Excellent ○ : Good

ISO Material Description	P										M				K						
	Non-alloy steel					Low alloy steel					High alloyed steel, and tool steel				Stainless steel		Grey cast iron		Nodular cast iron		Malleable cast iron
VDI 3323	1	2	3	4	5	6	7	8	9	10	11	12	13	14	15	16	17	18	19	20	
HRc	13	25	28	32	10	29	32	38	15	35	15	23	10	10	26	3	25				
HB	125	190	250	270	300	180	275	300	350	200	325	200	240	180	180	260	160	250	130	230	
Recommend																					
ISO Material Description	N										S							H			
	Aluminum-wrought alloy		Aluminum-cast, alloyed			Copper and Copper Alloys (Bronze / Brass)			Non Metallic Materials		Heat Resistant Super Alloys					Titanium Alloys		Hardened steel	Chilled Cast Iron	Hardened Cast Iron	
VDI 3323	21	22	23	24	25	26	27	28	29	30	31	32	33	34	35	36	37	38	39	40	41
HRc											15	30	25	38	34			55	60	42	55
HB	60	100	75	90	130	110	90	100			200	280	250	350	320	400 Rm	1050 Rm	550	630	400	550
Recommend	◎	◎	◎	◎	○																

CARBIDE, 2 FLUTE 45° HELIX LONG LENGTH

- VOLLHARTMETALL, 2 SCHNEIDEN 45° RECHTSSPIRALE LANG
- Fraise carbure, 2 dents, hélice 45°, longue
- 2 TAGLIANTI, ELICA 45°, SERIE LUNGA

- ▶ Suitable for high speed machining in aluminum and other non-ferrous materials
- ▶ Mirror surface - Excellent surface finish
- ▶ Superior chip evacuation
- ▶ Reduces chipping of corner edges
- ▶ Zur HSC- Bearbeitung von Aluminium und anderen Nichteisenmetallen.
- ▶ Spiegel-Oberfläche - Hervorragendes Oberflächenfinishing.
- ▶ Überlegene Spanabfuhr
- ▶ Reduzierung von Schneideckenausbrüchen.

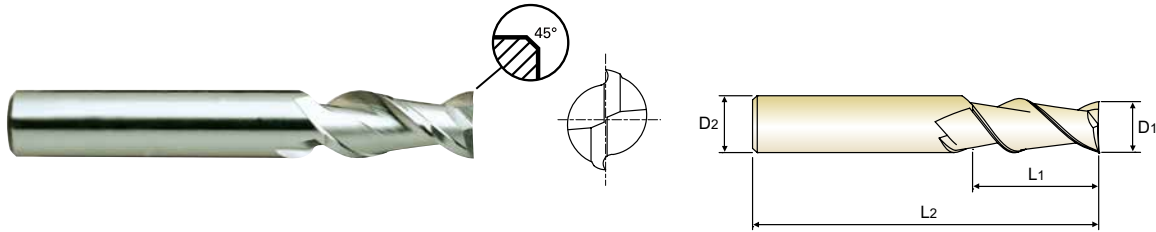

Unit : mm

EDP No.		Mill Diameter	Shank Diameter	Length of Cut	Overall length	Chamfer
PLAIN	FLAT	D1	D2	L1	L2	
E5522030	E5521030	3.0	6	8	57	0.05
E5522040	E5521040	4.0	6	11	57	0.05
E5522050	E5521050	5.0	6	13	57	0.05
E5522060	E5521060	6.0	6	13	57	0.05
E5522080	E5521080	8.0	8	19	63	0.05
E5522100	E5521100	10.0	10	22	72	0.10
E5522120	E5521120	12.0	12	26	83	0.10
E5522140	E5521140	14.0	14	26	83	0.10
E5522160	E5521160	16.0	16	32	92	0.10
E5522180	E5521180	18.0	18	32	92	0.10
E5522200	E5521200	20.0	20	38	104	0.10

▶ TiN, TiCN and TiAlN Coatings are available on your request.

Mill Dia. Tolerance(mm)	Shank Dia. Tolerance
0 ~ -0.015	h5

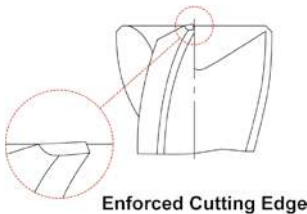
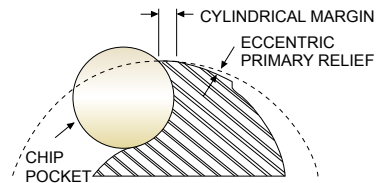

◎ : Excellent ○ : Good

ISO Material Description	P										M				K						
	Non-alloy steel					Low alloy steel					High alloyed steel, and tool steel				Stainless steel		Grey cast iron		Nodular cast iron		Malleable cast iron
VDI 3323	1	2	3	4	5	6	7	8	9	10	11	12	13	14	15	16	17	18	19	20	
HRC																					
HB	125	190	250	270	300	180	275	300	350	200	325	200	240	180	180	260	160	250	130	230	
Recommend																					
ISO Material Description	N					S					H										
	Aluminum-wrought alloy		Aluminum-cast, alloyed			Copper and Copper Alloys (Bronze / Brass)		Non Metallic Materials			Heat Resistant Super Alloys					Titanium Alloys		Hardened steel	Chilled Cast Iron	Hardened Cast Iron	
VDI 3323	21	22	23	24	25	26	27	28	29	30	31	32	33	34	35	36	37	38	39	40	41
HRC																					
HB	60	100	75	90	130	110	90	100			200	280	250	350	320	400 Rm	1050 Rm	550	630	400	550
Recommend	◎	◎		◎	○																

- CBN END MILLS
- i-Xmill END MILLS
- i-SMART MODULAR END MILLS
- X5070 END MILLS
- 4G MILL END MILLS
- X-POWER PRO END MILLS
- TitaNox-POWER END MILLS
- JET-POWER END MILLS
- V7 PLUS END MILLS
- ALU-POWER HPC END MILLS
- ALU-POWER END MILLS
- D-POWER GRAPHITE END MILLS
- D-POWER CFRP END MILLS
- ROUTERS
- CRX S END MILLS
- K-2 END MILLS
- ONLY ONE COATED PM60 END MILLS
- TANK-POWER END MILLS
- GENERAL HSS END MILLS
- MILLING CUTTERS
- TECHNICAL DATA

CARBIDE, 3 FLUTE 45° HELIX LONG LENGTH

- **VOLLHARTMETALL, 3 SCHNEIDEN 45° RECHTSSPIRALE LANG**
- **Fraise carbure, 3 dents, hélice 45°, longue**
- **3 TAGLIENTI, ELICA 45°, SERIE LUNGA**

- ▶ Excellent cutting qualities on aluminum and copper
- ▶ Increased tool life and higher cutting accuracy
- ▶ Mirror surface - Excellent surface finish
- ▶ Superior chip evacuation

- ▶ **Ausgezeichnete Schneideigenschaften in Aluminium, Kupfer**
- ▶ **Verbesserte Standzeiten und höhere Fräsgenauigkeit.**
- ▶ **Spiegel-Oberfläche - Hervorragendes Oberflächenfinishing.**
- ▶ **Überlegene Spanabfuhr**

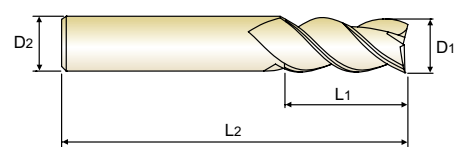
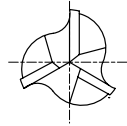

Unit : mm

EDP No.	Mill Diameter	Shank Diameter	Length of Cut	Overall Length
	D1	D2	L1	L2
E5E49030	3.0	6	12	57
E5E49040	4.0	6	15	57
E5E49050	5.0	6	20	57
E5E49060	6.0	6	20	65
E5E49080	8.0	8	22	65
E5E49100	10.0	10	25	70
E5E49120	12.0	12	25	75
E5E49160	16.0	16	35	90
E5E49200	20.0	20	40	100

▶ TiN, TiCN and TiAlN Coatings are available on your request.

Mill Dia. Tolerance(mm)	Shank Dia. Tolerance
0 ~ -0.015	h5

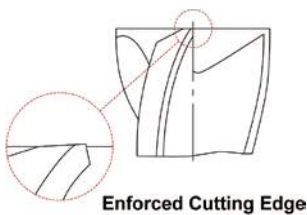
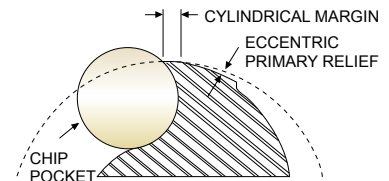

◎ : Excellent ○ : Good

ISO Material Description	P										M				K						
	Non-alloy steel					Low alloy steel					High alloyed steel, and tool steel				Stainless steel		Grey cast iron		Nodular cast iron		Malleable cast iron
VDI 3323	1	2	3	4	5	6	7	8	9	10	11	12	13	14	15	16	17	18	19	20	
HRc		13	25	28	32	10	29	32	38	15	35	15	23	10	10	26	3	25			
HB	125	190	250	270	300	180	275	300	350	200	325	200	240	180	180	260	160	250	130	230	
Recommend																					
ISO Material Description	N										S							H			
	Aluminum-wrought alloy		Aluminum-cast, alloyed			Copper and Copper Alloys (Bronze / Brass)			Non Metallic Materials		Heat Resistant Super Alloys					Titanium Alloys		Hardened steel	Chilled Cast Iron	Hardened Cast Iron	
VDI 3323	21	22	23	24	25	26	27	28	29	30	31	32	33	34	35	36	37	38	39	40	41
HRc											15	30	25	38	34			55	60	42	55
HB	60	100	75	90	130	110	90	100			200	280	250	350	320	400 Rm	1050 Rm	550	630	400	550
Recommend	◎	◎	◎	◎	○																

CARBIDE, 3 FLUTE 45° HELIX with NECK

● **VOLLHARTMETALL, 3 SCHNEIDEN 45° RECHTSSPIRALE mit ABGESETZTEM SCHAFTTETL**
 (●) **Fraise carbure, 3 dents, hélice 45°, détalonnée**
 (●) **3 TAGLIANTI, ELICA 45°, SCARICATA**

- ▶ Excellent cutting qualities on aluminum and copper
- ▶ Increased tool life and higher cutting accuracy
- ▶ Mirror surface - Excellent surface finish
- ▶ Superior chip evacuation

- ▶ **Ausgezeichnete Schneideigenschaften in Aluminium, Kupfer**
- ▶ **Verbesserte Standzeiten und höhere Fräsgenauigkeit.**
- ▶ **Spiegel-Oberfläche - Hervorragendes Oberflächenfinishing.**
- ▶ **Überlegene Spanabfuhr**

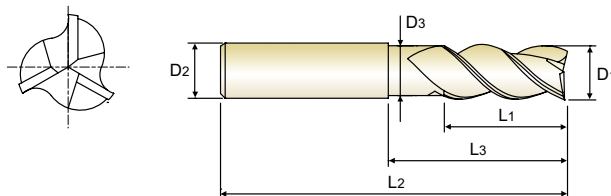

Unit : mm

EDP No.	Mill Diameter	Shank Diameter	Length of Cut	Length Below Shank	Overall Length	Neck Diameter
	D1	D2	L1	L3	L2	D3
E5E50030	3.0	6	8	12	57	2.7
E5E50040	4.0	6	11	18	57	3.7
E5E50050	5.0	6	13	18	57	4.7
E5E50060	6.0	6	13	18	57	5.7
E5E50080	8.0	8	21	25	63	7.4
E5E50100	10.0	10	22	30	72	9.2
E5E50120	12.0	12	26	36	83	11
E5E50160	16.0	16	36	42	92	15
E5E50200	20.0	20	41	52	104	19

▶ TiN, TiCN and TiAlN Coatings are available on your request.

Mill Dia. Tolerance(mm)	Shank Dia. Tolerance
0 ~ -0.015	h5

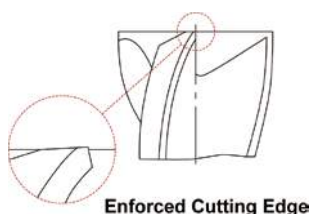
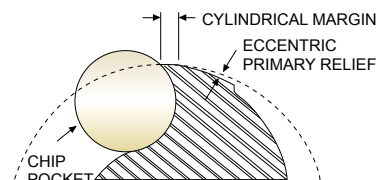

◎ : Excellent ○ : Good

ISO Material Description	P										M				K								
	Non-alloy steel					Low alloy steel					High alloyed steel, and tool steel				Stainless steel				Grey cast iron		Nodular cast iron		Malleable cast iron
VDI 3323	1	2	3	4	5	6	7	8	9	10	11	12	13	14	15	16	17	18	19	20			
HRc																							
HB	125	190	250	270	300	180	275	300	350	200	325	200	240	180	180	260	160	250	130	230			
Recommend																							
ISO Material Description	N					S					H												
	Aluminum-wrought alloy		Aluminum-cast, alloyed			Copper and Copper Alloys (Bronze / Brass)		Non Metallic Materials			Heat Resistant Super Alloys					Titanium Alloys		Hardened steel	Chilled Cast Iron	Hardened Cast Iron			
VDI 3323	21	22	23	24	25	26	27	28	29	30	31	32	33	34	35	36	37	38	39	40	41		
HRc																							
HB	60	100	75	90	130	110	90	100			200	280	250	350	320	400 Rm	1050 Rm	550	630	400	550		
Recommend	◎	◎	◎	◎	◎																		

CARBIDE, 3 FLUTE LONG LENGTH ROUGHING

- **VOLLHARTMETALL, 3 SCHNEIDEN LANG SCHRUPPFÄSER**
- **Fraise carbure, 3 dents, ébauche, longue**
- **3 TAGLIENTI, PER SGROSSATURA, SERIE LUNGA**

- ▶ Excellent cutting qualities on aluminum and copper
- ▶ Increased tool life and higher cutting accuracy
- ▶ Mirror surface - Excellent surface finish

- ▶ **Ausgezeichnete Schneideigenschaften in Aluminium, Kupfer**
- ▶ **Verbesserte Standzeiten und höhere Fräsgenauigkeit.**
- ▶ **Spiegel-Oberfläche - Hervorragendes Oberflächenfinishing.**

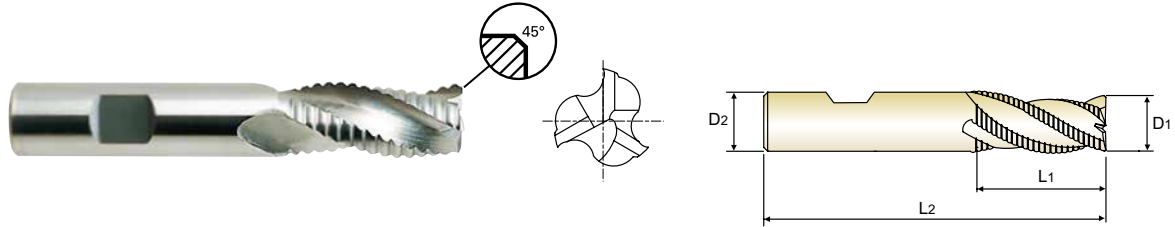

Unit : mm

EDP No.		Mill Diameter	Shank Diameter	Length of Cut	Overall length	Chamfer
PLAIN	FLAT	D1	D2	L1	L2	
E5742060	E5711060	6.0	6	16	57	0.60
E5742070	E5711070	7.0	8	16	63	0.60
E5742080	E5711080	8.0	8	16	63	0.60
E5742090	E5711090	9.0	10	19	72	0.60
E5742100	E5711100	10.0	10	22	72	0.60
E5742120	E5711120	12.0	12	26	83	0.60
E5742140	E5711140	14.0	14	26	83	0.91
E5742160	E5711160	16.0	16	32	92	0.91
E5742180	E5711180	18.0	18	32	92	0.91
E5742200	E5711200	20.0	20	38	104	0.91
E5742250	E5711250	25.0	25	45	121	0.91

▶ TiN, TiCN and TiAlN Coatings are available on your request.

Tolerances according to DIN 7160 & 7161

Tolerance range in μm					
Nominal-Diameter in mm					
	from 1 to 3	over 3 to 6	over 6 to 10	over 10 to 18	over 18 to 30
h10	0 - 40	0 - 48	0 - 58	0 - 70	0 - 84
h5	0 - 4	0 - 5	0 - 6	0 - 8	0 - 9

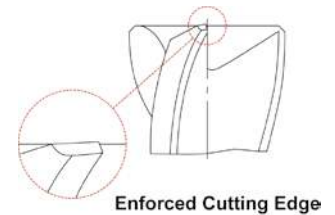

◎ : Excellent ○ : Good

ISO	P											M			K						
Material Description	Non-alloy steel					Low alloy steel				High alloyed steel, and tool steel		Stainless steel			Grey cast iron		Nodular cast iron		Malleable cast iron		
VDI 3323	1	2	3	4	5	6	7	8	9	10	11	12	13	14	15	16	17	18	19	20	
HRc		13	25	28	32	10	29	32	38	15	35	15	23	10	10	26	3	25		21	
HB	125	190	250	270	300	180	275	300	350	200	325	200	240	180	180	260	160	250	130	230	
Recommend	○	○	○	○	○	○	○			○					○	○	○	○	○	○	
ISO	N									S							H				
Material Description	Aluminum-wrought alloy		Aluminum-cast, alloyed			Copper and Copper Alloys (Bronze / Brass)		Non Metallic Materials		Heat Resistant Super Alloys					Titanium Alloys		Hardened steel	Chilled Cast Iron	Hardened Cast Iron		
VDI 3323	21	22	23	24	25	26	27	28	29	30	31	32	33	34	35	36	37	38	39	40	41
HRc											15	30	25	38	34			55	60	42	55
HB	60	100	75	90	130	110	90	100			200	280	250	350	320	400 Rm	1050 Rm	550	630	400	550
Recommend	◎	◎	◎	◎	○																

CARBIDE, 3 FLUTE ROUGHING with NECK

- VOLLHARTMETALL, 3 SCHNEIDEN SCHRUPPFÄRER mit ABGESETZTEM SCHAFTTETL
- Fraise carbure, 3 dents, ébauche détalonnée
- 3 TAGLIANTI, PER SGROSSATURA, SCARICATA

- ▶ Excellent cutting qualities on aluminum and copper
- ▶ Increased tool life and higher cutting accuracy
- ▶ Mirror surface - Excellent surface finish
- ▶ Ausgezeichnete Schneideigenschaften in Aluminium, Kupfer
- ▶ Verbesserte Standzeiten und höhere Fräsgenauigkeit.
- ▶ Spiegel-Oberfläche - Hervorragendes Oberflächenfinishing.

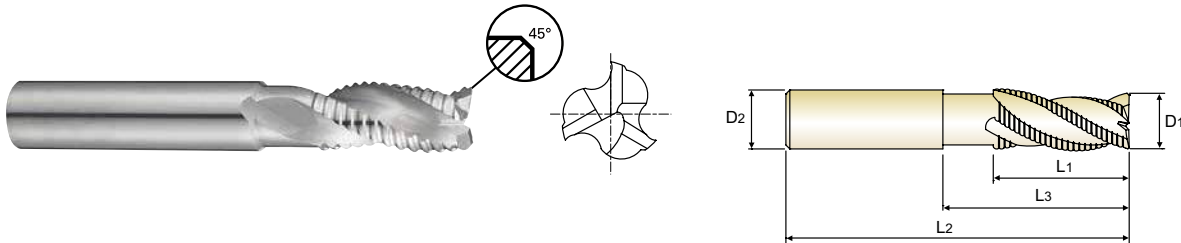

Unit : mm

EDP No.		Mill Diameter	Shank Diameter	Length of Cut	Length Below Shank	Overall length	Neck Diameter	Chamfer
PLAIN	FLAT	D1	D2	L1	L3	L2	D3	
E5E39060	E5E40060	6.0	6	16	20	57	5	0.60
E5E39080	E5E40080	8.0	8	16	25	63	7	0.60
E5E39100	E5E40100	10.0	10	22	30	72	9	0.60
E5E39120	E5E40120	12.0	12	26	36	83	10.5	0.60
E5E39160	E5E40160	16.0	16	32	42	92	14.5	0.91
E5E39200	E5E40200	20.0	20	38	52	104	18.5	0.91

▶ TiN, TiCN and TiAlN Coatings are available on your request.

Tolerances according to DIN 7160 & 7161

Tolerance range in μm					
Nominal-Diameter in mm					
	from 1 to 3	over 3 to 6	over 6 to 10	over 10 to 18	over 18 to 30
h10	0 - 40	0 - 48	0 - 58	0 - 70	0 - 84
h5	0 - 4	0 - 5	0 - 6	0 - 8	0 - 9

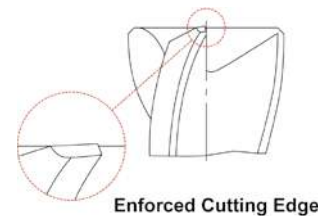

◎ : Excellent ○ : Good

ISO Material Description	P										M				K								
	Non-alloy steel					Low alloy steel					High alloyed steel, and tool steel				Stainless steel				Grey cast iron		Nodular cast iron		Malleable cast iron
VDI 3323	1	2	3	4	5	6	7	8	9	10	11	12	13	14	15	16	17	18	19	20			
HRC																							
HB	125	190	250	270	300	180	275	300	350	200	325	200	240	180	180	260	160	250	130	230			
Recommend	○	○	○	○	○	○	○			○	○				○	○	○	○	○	○			
ISO Material Description	N					S					H												
	Aluminum-wrought alloy		Aluminum-cast, alloyed			Copper and Copper Alloys (Bronze / Brass)			Non Metallic Materials		Heat Resistant Super Alloys					Titanium Alloys		Hardened steel	Chilled Cast Iron	Hardened Cast Iron			
VDI 3323	21	22	23	24	25	26	27	28	29	30	31	32	33	34	35	36	37	38	39	40	41		
HRC																							
HB	60	100	75	90	130	110	90	100			200	280	250	350	320	400 Rm	1050 Rm	550	630	400	550		
Recommend	◎	◎	◎	◎	○																		

- CBN END MILLS
- i-Xmill END MILLS
- i-SMART MODULAR END MILLS
- X5070 END MILLS
- 4G MILL END MILLS
- X-POWER PRO END MILLS
- TitaNox-POWER END MILLS
- JET-POWER END MILLS
- V7 PLUS END MILLS
- ALU-POWER HPC END MILLS
- ALU-POWER END MILLS
- D-POWER GRAPHITE END MILLS
- D-POWER CFRP END MILLS
- ROUTERS
- CRX S END MILLS
- K-2 END MILLS
- ONLY ONE COATED PM60 END MILLS
- TANK-POWER END MILLS
- GENERAL HSS END MILLS
- MILLING CUTTERS
- TECHNICAL DATA

YPM, 3 FLUTE 42° HELIX SHORT LENGTH ROUGHING TiAIN COATED

- PREMIUM HSS-PM, 3 SCHNEIDEN 42° RECHTSSPIRALE KURZ SCHRUPPFÄRER TiAIN-BESCHICHTET
- Fraise YPM, 3 dents, ébauche, hélice 42°, revêtue TiAIN, courte
- 3 TAGLIENTI, CORTA, ELICA 42°, RIVESTITA TiAIN PER SGROSSATURA - HSS PM

- ▶ Maximum metal removal rate at High Speed Condition
- ▶ Reduces vibrations and improves surface roughness
- ▶ Reduces chipping of corner edges

- ▶ Maximale Zerspanungsleistung bei der High-Speed-Bearbeitung (HSC)
- ▶ Reduziert Vibrationen und verbessert die Oberflächenrauigkeit
- ▶ Reduzierung von Schneideckenausbrüchen.



HSS PM
WR
3
42°
PLAIN
FLAT
C x 45°
P.498

Unit : mm

EDP No.	Mill Diameter		Shank Diameter	Length of Cut		Overall length	Chamfer
	PLAIN	FLAT		D1(js12)	D2(h6)		
▲ EP922120	▲ EP923120	12.0	12	26	83	1.10	
▲ EP922140	▲ EP923140	14.0	12	26	83	1.10	
▲ EP922160	▲ EP923160	16.0	16	32	92	1.10	
▲ EP922180	▲ EP923180	18.0	16	32	92	1.10	
▲ EP922200	▲ EP923200	20.0	20	38	104	1.10	
▲ EP922220	▲ EP923220	22.0	20	38	104	1.10	
▲ EP922250	▲ EP923250	25.0	25	45	121	1.10	
▲ EP922280	▲ EP923280	28.0	25	45	121	1.22	

▲ : Only available till stock runs out

Tolerances according to DIN 7160 & 7161

		Tolerance range in μm					
		Nominal-Diameter in mm					
		from 1 to 3	over 3 to 6	over 6 to 10	over 10 to 18	over 18 to 30	over 30 to 50
js12		± 50	± 60	± 75	± 90	± 105	± 125
h6		0 -6	0 -8	0 -9	0 -11	0 -13	0 -16

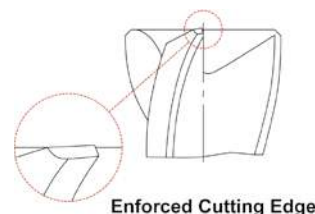

Enforced Cutting Edge

◎ : Excellent ○ : Good

ISO	P										M				K						
	Non-alloy steel					Low alloy steel					High alloyed steel, and tool steel				Stainless steel		Grey cast iron		Nodular cast iron		Malleable cast iron
Material Description	1	2	3	4	5	6	7	8	9	10	11	12	13	14	15	16	17	18	19	20	
VDI 3323	1	2	3	4	5	6	7	8	9	10	11	12	13	14	15	16	17	18	19	20	
HRc	13	13	25	28	32	10	29	32	38	15	35	15	23	10	10	26	3	25		21	
HB	125	190	250	270	300	180	275	300	350	200	325	200	240	180	180	260	160	250	130	230	
Recommend															○	○	○	○	○	○	
ISO	N									S							H				
	Aluminum-wrought alloy		Aluminum-cast, alloyed			Copper and Copper Alloys (Bronze / Brass)				Non Metallic Materials		Heat Resistant Super Alloys					Titanium Alloys		Hardened steel	Chilled Cast Iron	Hardened Cast Iron
Material Description	21	22	23	24	25	26	27	28	29	30	31	32	33	34	35	36	37	38	39	40	41
VDI 3323	21	22	23	24	25	26	27	28	29	30	31	32	33	34	35	36	37	38	39	40	41
HRc	60	100	75	90	130	110	90	100			15	30	25	38	34	55	60	42	55		
HB	60	100	75	90	130	110	90	100			200	280	250	350	320	400 Rm	1050 Rm	550	630	400	550
Recommend	◎	◎	◎	◎	○																

YPM, 3 FLUTE 42° HELIX LONG LENGTH ROUGHING TiAlN COATED

- PREMIUM HSS-PM, 3 SCHNEIDEN 42° RECHTSSPIRALE LANG SCHRUPPFÄSER TiAlN-BESCHICHTET
- Fraise YPM, 3 dents, ébauche, hélice 42°, revêtue TiAlN, longue
- 3 TAGLIANTI, CORTA, ELICA 42°, RIVESTITA TiAlN PER SGROSSATURA - HSS PM

- Maximum metal removal rate at High Speed Condition
- Reduces vibrations and improves surface roughness
- Reduces chipping of corner edges
- Maximale Zerspanungsleistung bei der High-Speed-Bearbeitung (HSC)
- Reduziert Vibrationen und verbessert die Oberflächenrauigkeit
- Reduzierung von Schneidekrenausrüchen.



HSS PM WR 3 42° PLAIN FLAT C x 45° P.498

Unit : mm

EDP No.		Mill Diameter	Shank Diameter	Length of Cut	Overall length	Chamfer
PLAIN	FLAT	D1(js12)	D2(h6)	L1	L2	
▲ EP924120	▲ EP925120	12.0	12	53	110	1.10
-	▲ EP925140	14.0	12	53	110	1.10
▲ EP924160	▲ EP925160	16.0	16	63	123	1.10
▲ EP924200	▲ EP925200	20.0	20	75	141	1.10
▲ EP924220	-	22.0	20	75	141	1.10
-	▲ EP925250	25.0	25	90	166	1.10
-	▲ EP925280	28.0	25	90	166	1.22
▲ EP924320	▲ EP925320	32.0	32	106	186	1.22

▲ : Only available till stock runs out

Tolerances according to DIN 7160 & 7161

		Tolerance range in μm					
		Nominal-Diameter in mm					
		from 1 to 3	over 3 to 6	over 6 to 10	over 10 to 18	over 18 to 30	over 30 to 50
js12		± 50	± 60	± 75	± 90	± 105	± 125
h6		$\begin{matrix} 0 \\ -6 \end{matrix}$	$\begin{matrix} 0 \\ -8 \end{matrix}$	$\begin{matrix} 0 \\ -9 \end{matrix}$	$\begin{matrix} 0 \\ -11 \end{matrix}$	$\begin{matrix} 0 \\ -13 \end{matrix}$	$\begin{matrix} 0 \\ -16 \end{matrix}$

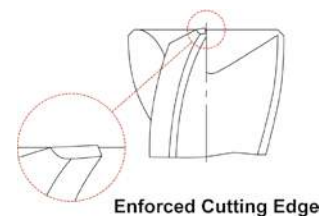

◎ : Excellent ○ : Good

ISO Material Description	P										M				K								
	Non-alloy steel					Low alloy steel					High alloyed steel, and tool steel				Stainless steel				Grey cast iron		Nodular cast iron		Malleable cast iron
VDI 3323	1	2	3	4	5	6	7	8	9	10	11	12	13	14	15	16	17	18	19	20			
HRc		13	25	28	32	10	29	32	38	15	35	15	23	10	10	26	3	25		21			
HB	125	190	250	270	300	180	275	300	350	200	325	200	240	180	180	260	160	250	130	230			
Recommend															○	○	○	○	○	○			

ISO Material Description	N					S					H										
	Aluminum-wrought alloy		Aluminum-cast, alloyed			Copper and Copper Alloys (Bronze / Brass)		Non Metallic Materials			Heat Resistant Super Alloys					Titanium Alloys		Hardened steel	Chilled Cast Iron	Hardened Cast Iron	
VDI 3323	21	22	23	24	25	26	27	28	29	30	31	32	33	34	35	36	37	38	39	40	41
HRc											15	30	25	38	34	55	60	55	60	42	55
HB	60	100	75	90	130	110	90	100			200	280	250	350	320	400 Rm	1050 Rm	550	630	400	550
Recommend	◎	◎	◎	◎	○																

YG ALU-POWER END MILLS

RECOMMENDED CUTTING CONDITIONS EMPFOHLENE SCHNEIDPARAMETER

E5910 SERIES 2 FLUTE BALL

Vc = m/min.
fz = mm/tooth
RPM = rev./min.
FEED = mm/min.

ISO	VDI 3323	Material Description	Ae	Ap	Parameter	Mill Diameter (Ø)					
						6.0	8.0	10.0	12.0	16.0	20.0
N	21~22	Aluminum-wrought alloy	0.2D	0.5D	Vc	270	280	350	420	440	350
					fz	0.049	0.071	0.084	0.107	0.123	0.157
					RPM	14324	11141	11141	11141	8754	5570
	23~24	Aluminum-cast, alloyed	0.2D	0.5D	Vc	176	182	228	273	286	228
					fz	0.049	0.071	0.084	0.107	0.123	0.157
					RPM	9311	7242	7242	7242	5690	3621
	26-28	Copper and Copper Alloys (Bronze / Brass)	0.2D	0.5D	Vc	85	85	105	125	135	105
					fz	0.04	0.06	0.069	0.089	0.101	0.131
					RPM	4509	3382	3342	3316	2686	1671
FEED	361	406	461	590	543	438					

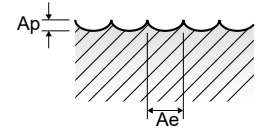

E5908 SERIES 3 FLUTE BALL

ISO	VDI 3323	Material Description	Ae	Ap	Parameter	Mill Diameter (Ø)										
						2.0	2.5	3.0	3.5	4.0	5.0	6.0	8.0	10.0	12.0	16.0
N	21~22	Aluminum-wrought alloy	0.2D	0.5D	Vc	135	140	135	160	180	225	270	280	350	420	440
					fz	0.018	0.022	0.026	0.028	0.035	0.038	0.049	0.071	0.084	0.107	0.123
					RPM	21486	17825	14324	14551	14324	14324	11141	11141	11141	8754	3230
	23~24	Aluminum-cast, alloyed	0.2D	0.5D	Vc	88	91	88	104	117	146	176	182	228	273	286
					fz	0.018	0.022	0.026	0.028	0.035	0.038	0.049	0.071	0.084	0.107	0.123
					RPM	13966	11586	9311	9458	9311	9311	7242	7242	7242	5690	2100
	26-28	Copper and Copper Alloys (Bronze / Brass)	0.2D	0.5D	Vc	40	40	40	50	55	70	85	85	105	125	135
					fz	0.015	0.018	0.022	0.022	0.028	0.031	0.04	0.06	0.069	0.089	0.101
					RPM	6366	5093	4244	4547	4377	4456	4509	3382	3342	3316	2686
FEED	286	275	280	300	368	414	541	609	692	885	814					

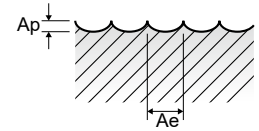

E5930 SERIES

2 FLUTE CORNER RADIUS - SLOTTING

ISO	VDI 3323	Material Description	Ae	Ap	Parameter	Mill Diameter (Ø)									
						2.0	3.0	4.0	5.0	6.0	8.0	10.0	12.0	16.0	20.0
N	21~22	Aluminum-wrought alloy	1.0D	0.5D	Vc	65	100	130	165	195	200	250	300	320	250
					fz	0.022	0.035	0.046	0.05	0.058	0.09	0.11	0.135	0.156	0.2
					RPM	10345	10610	10345	10504	10345	7958	7958	7958	6366	3979
	23~24	Aluminum-cast, alloyed	1.0D	0.5D	Vc	42	65	85	107	127	130	163	195	208	163
					fz	0.022	0.035	0.046	0.05	0.058	0.09	0.11	0.135	0.156	0.2
					RPM	6724	6897	6724	6828	6724	5173	5173	5173	4138	2586
FEED	296	483	619	683	780	931	1138	1397	1291	1035					

2 FLUTE CORNER RADIUS - SIDE CUTTING

ISO	VDI 3323	Material Description	Ae	Ap	Parameter	Mill Diameter (Ø)									
						2.0	3.0	4.0	5.0	6.0	8.0	10.0	12.0	16.0	20.0
N	21~22	Aluminum-wrought alloy	0.2~0.10-0.25D 0.12~0.20-0.5D	1.0D	Vc	65	100	130	165	195	200	250	300	320	250
					fz	0.039	0.046	0.054	0.065	0.077	0.115	0.135	0.170	0.194	0.250
					RPM	10345	10610	10345	10504	10345	7958	7958	7958	6366	3979
	23~24	Aluminum-cast, alloyed	0.2~0.10-0.25D 0.12~0.20-0.5D	1.0D	Vc	42	65	85	107	127	130	163	195	208	163
					fz	0.039	0.046	0.054	0.065	0.077	0.115	0.135	0.170	0.194	0.250
					RPM	6724	6897	6724	6828	6724	5173	5173	5173	4138	2586
FEED	524	634	726	888	1036	1190	1397	1759	1606	1293					

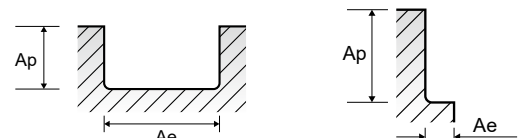

Vc = m/min.
fz = mm/tooth
RPM = rev./min.
FEED = mm/min.

E5909 SERIES

2 FLUTE CORNER RADIUS - SLOTTING

ISO	VDI 3323	Material Description	Ae	Ap	Parameter	Mill Diameter (Ø)						
						4.0	6.0	8.0	10.0	12.0	16.0	20.0
N	21~22	Aluminum-wrought alloy	1.0D	0.5D	Vc	130	195	200	250	300	320	250
					fz	0.046	0.058	0.09	0.11	0.135	0.156	0.2
					RPM	10345	10345	7958	7958	7958	6366	3979
	23~24	Aluminum-cast, alloyed	1.0D	0.5D	Vc	85	127	130	163	195	208	163
					fz	0.046	0.058	0.09	0.11	0.135	0.156	0.2
					RPM	6724	6724	5173	5173	5173	4138	2586
26-28	Copper and Copper Alloys (Bronze / Brass)	1.0D	0.5D	Vc	40	60	60	75	90	95	75	
				fz	0.038	0.049	0.075	0.092	0.114	0.132	0.167	
				RPM	3183	3183	2387	2387	2387	1890	1194	
FEED	242	312	358	439	544	499	399					

2 FLUTE CORNER RADIUS - SIDE CUTTING

ISO	VDI 3323	Material Description	Ae	Ap	Parameter	Mill Diameter (Ø)						
						4.0	6.0	8.0	10.0	12.0	16.0	20.0
N	21~22	Aluminum-wrought alloy	~Ø10=0.25D Ø12~Ø20=0.5D	1.0D	Vc	130	195	200	250	300	320	250
					fz	0.054	0.077	0.115	0.135	0.17	0.194	0.25
					RPM	10345	10345	7958	7958	7958	6366	3979
	23~24	Aluminum-cast, alloyed	~Ø10=0.25D Ø12~Ø20=0.5D	1.0D	Vc	85	127	130	163	195	208	163
					fz	0.054	0.077	0.115	0.135	0.17	0.194	0.25
					RPM	6724	6724	5173	5173	5173	4138	2586
26-28	Copper and Copper Alloys (Bronze / Brass)	~Ø10=0.25D Ø12~Ø20=0.5D	1.0D	Vc	40	60	60	75	90	95	75	
				fz	0.045	0.064	0.097	0.114	0.142	0.163	0.21	
				RPM	3183	3183	2387	2387	2387	1890	1194	
FEED	286	407	463	544	678	616	501					

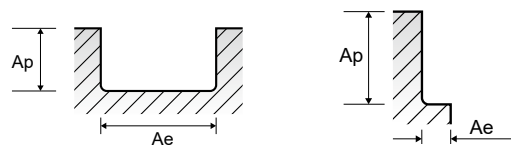

E5E51 SERIES

3 FLUTE CORNER RADIUS - SLOTTING

ISO	VDI 3323	Material Description	Ae	Ap	Parameter	Mill Diameter (Ø)								
						3.0	4.0	5.0	6.0	8.0	10.0	12.0	16.0	20.0
N	21~22	Aluminum-wrought alloy	1.0D	0.5D	Vc	95	125	155	190	200	250	300	300	250
					fz	0.039	0.050	0.055	0.066	0.096	0.117	0.145	0.174	0.220
					RPM	10080	9947	9868	10080	7958	7958	7958	5968	3979
	23~24	Aluminum-cast, alloyed	1.0D	0.5D	Vc	62	81	101	124	130	163	195	195	163
					fz	0.039	0.050	0.055	0.066	0.096	0.117	0.145	0.174	0.220
					RPM	6552	6466	6414	6552	5173	5173	5173	3879	2586
FEED	767	970	1058	1297	1490	1816	2250	2025	1707					

3 FLUTE CORNER RADIUS - SIDE CUTTING

ISO	VDI 3323	Material Description	Ae	Ap	Parameter	Mill Diameter (Ø)								
						3.0	4.0	5.0	6.0	8.0	10.0	12.0	16.0	20.0
N	21~22	Aluminum-wrought alloy	0.15D	2.5D	Vc	95	125	155	190	200	250	300	300	250
					fz	0.050	0.061	0.072	0.083	0.125	0.145	0.179	0.220	0.262
					RPM	10080	9947	9868	10080	7958	7958	7958	5968	3979
	23~24	Aluminum-cast, alloyed	0.15D	2.5D	Vc	62	81	101	124	130	163	195	195	163
					fz	0.050	0.061	0.072	0.083	0.125	0.145	0.179	0.220	0.262
					RPM	6552	6466	6414	6552	5173	5173	5173	3879	2586
FEED	983	1183	1385	1631	1940	2250	2778	2560	2033					

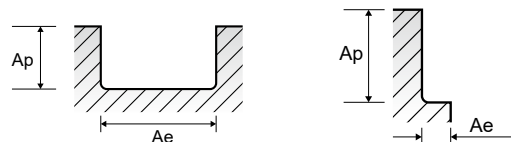

E5E47 SERIES

1 FLUTE - SLOTTING

Vc = m/min.
fz = mm/tooth
RPM = rev./min.
FEED = mm/min.

ISO	VDI 3323	Material Description	Ae	Ap	Parameter	Mill Diameter (Ø)								
						2.0	3.0	4.0	5.0	6.0	8.0	10.0	12.0	
N	21~22	Aluminum-wrought alloy	1.0D	1.5D	Vc	145	170	190	190	190	195	190	190	
					fz	0.065	0.094	0.120	0.150	0.180	0.244	0.333	0.440	
					RPM	23077	18038	15120	12096	10080	7759	6048	5040	
N	23~24	Aluminum-cast, alloyed	1.0D	1.5D	Vc	94	111	124	124	124	127	124	124	
					fz	0.065	0.094	0.120	0.150	0.180	0.244	0.333	0.440	
					RPM	15000	11724	9828	7862	6552	5043	3931	3276	
N	29.1	Non Metallic Materials (Duroplastic)	1.0D	1.5D	Vc	200	235	250	235	255	250	250	255	
					fz	0.069	0.096	0.120	0.147	0.170	0.240	0.300	0.343	
					RPM	31831	24934	19894	14961	13528	9947	7958	6764	
					FEED	2196	2394	2387	2199	2300	2387	2387	2387	2320

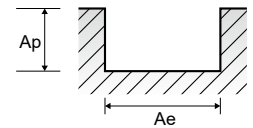

E5E48, E5522, E5521 SERIES

2 FLUTE - SLOTTING

ISO	VDI 3323	Material Description	Ae	Ap	Parameter	Mill Diameter (Ø)										
						3.0	4.0	5.0	6.0	8.0	10.0	12.0	14.0	16.0	18.0	20.0
N	21~22	Aluminum-wrought alloy	1.0D	0.5D	Vc	95	125	155	190	200	250	300	265	300	225	250
					fz	0.035	0.045	0.050	0.060	0.088	0.106	0.131	0.150	0.158	0.175	0.200
					RPM	10080	9947	9868	10080	7958	7958	7958	6025	5968	3979	3979
N	23~24	Aluminum-cast, alloyed	1.0D	0.5D	Vc	62	81	101	124	130	163	195	172	195	146	163
					fz	0.035	0.045	0.050	0.060	0.088	0.106	0.131	0.150	0.158	0.175	0.200
					RPM	6552	6466	6414	6552	5173	5173	5173	3916	3879	2586	2586
					FEED	459	582	641	786	910	1097	1355	1175	1226	905	1035

2 FLUTE - SIDE CUTTING

ISO	VDI 3323	Material Description	Ae	Ap	Parameter	Mill Diameter (Ø)										
						3.0	4.0	5.0	6.0	8.0	10.0	12.0	14.0	16.0	18.0	20.0
N	21~22	Aluminum-wrought alloy	Ø3~Ø10-0.25D Ø12~Ø20-0.5D	1.0D	Vc	95	125	155	190	200	250	300	265	300	225	250
					fz	0.045	0.055	0.065	0.075	0.113	0.131	0.163	0.183	0.200	0.225	0.238
					RPM	10080	9947	9868	10080	7958	7958	7958	6025	5968	3979	3979
					FEED	907	1094	1283	1512	1798	2085	2594	2205	2387	1790	1894
N	23~24	Aluminum-cast, alloyed	Ø3~Ø10-0.25D Ø12~Ø20-0.5D	1.0D	Vc	62	81	101	124	130	163	195	172	195	146	163
					fz	0.045	0.055	0.065	0.075	0.113	0.131	0.163	0.183	0.200	0.225	0.238
					RPM	6552	6466	6414	6552	5173	5173	5173	3916	3879	2586	2586
					FEED	590	711	834	983	1169	1355	1686	1433	1552	1164	1231

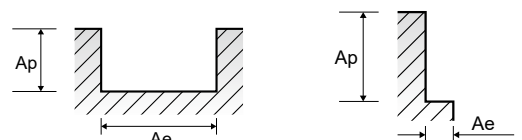

Vc = m/min.
fz = mm/tooth
RPM = rev./min.
FEED = mm/min.

E5E49, E5E50 SERIES

3 FLUTE - SLOTING

ISO	VDI 3323	Material Description	Ae	Ap	Parameter	Mill Diameter (Ø)									
						3.0	4.0	5.0	6.0	8.0	9.0	10.0	12.0	16.0	20.0
N	21~22	Aluminum-wrought alloy	1.0D	0.5D	Vc	65	90	110	130	140	160	175	210	210	175
					fz	0.035	0.045	0.050	0.060	0.088	0.097	0.106	0.131	0.158	0.200
					RPM	6897	7162	7003	6897	5570	5659	5570	5570	4178	2785
	FEED	724	967	1050	1241	1471	1647	1771	2189	1980	1671				
	23~24	Aluminum-cast, alloyed	1.0D	0.5D	Vc	42	59	72	85	91	104	114	137	137	114
					fz	0.035	0.045	0.050	0.060	0.088	0.097	0.106	0.131	0.158	0.200
RPM					4483	4655	4552	4483	3621	3678	3621	3621	2716	1810	
FEED	471	628	683	807	956	1070	1151	1423	1287	1086					

3 FLUTE - SIDE CUTTING

ISO	VDI 3323	Material Description	Ae	Ap	Parameter	Mill Diameter (Ø)									
						3.0	4.0	5.0	6.0	8.0	9.0	10.0	12.0	16.0	20.0
N	21~22	Aluminum-wrought alloy	0.15D	1.5D ~ 2.5D	Vc	65	90	110	130	140	160	175	210	210	175
					fz	0.045	0.055	0.065	0.075	0.113	0.122	0.131	0.163	0.200	0.238
					RPM	6897	7162	7003	6897	5570	5659	5570	5570	4178	2785
	FEED	931	1182	1366	1552	1888	2071	2189	2724	2507	1989				
	23~24	Aluminum-cast, alloyed	0.15D	1.5D ~ 2.5D	Vc	42	59	72	85	91	104	114	137	137	114
					fz	0.045	0.055	0.065	0.075	0.113	0.122	0.131	0.163	0.200	0.238
RPM					4483	4655	4552	4483	3621	3678	3621	3621	2716	1810	
FEED	605	768	888	1009	1227	1346	1423	1771	1629	1293					

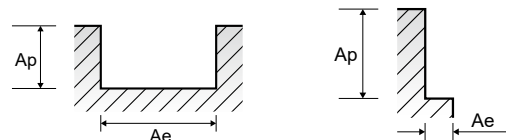

E5E39, E5E40, E5742, E5711 SERIES

3 FLUTE ROUGHING - SLOTING

ISO	VDI 3323	Material Description	Ae	Ap	Parameter	Mill Diameter (Ø)					
						6.0	8.0	10.0	12.0	16.0	20.0
N	21~22	Aluminum-wrought alloy	1.0D	1.5D	Vc	198	201	204	241	241	242
					fz	0.168	0.167	0.179	0.167	0.167	0.165
					RPM	10504	7998	6494	6393	4795	3852
	FEED	5294	4007	3487	3203	2402	1907				
	23~24	Aluminum-cast, alloyed	1.0D	1.5D	Vc	129	131	133	157	157	157
					fz	0.168	0.167	0.179	0.167	0.167	0.165
RPM					6828	5198	4221	4155	3116	2504	
FEED	3441	2604	2267	2082	1561	1239					

3 FLUTE ROUGHING - SIDE CUTTING

ISO	VDI 3323	Material Description	Ae	Ap	Parameter	Mill Diameter (Ø)			
						6.0	8.0	10.0	12.0
N	21~22	Aluminum-wrought alloy	0.5D	1.5D	Vc	254	264	267	320
					fz	0.168	0.168	0.169	0.165
					RPM	13475	10504	8499	8488
	FEED	6791	5294	4309	4202				
	23~24	Aluminum-cast, alloyed	0.5D	1.5D	Vc	165	172	174	208
					fz	0.168	0.168	0.169	0.165
RPM					8759	6828	5524	5517	
FEED	4414	3441	2801	2731					

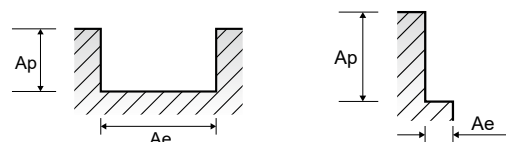

EP922, EP923, EP924, EP925 SERIES

3 FLUTE ROUGHING - SLOTTING

ISO	VDI 3323	Material Description	Ae	Ap	Parameter	Mill Diameter (Ø)									
						12.0	14.0	16.0	18.0	20.0	22.0	25.0	28.0	32.0	
N	21~22	Aluminum-wrought alloy	1.0D	0.5D	Vc	105	110	110	110	105	110	110	110	110	
					fz	0.049	0.060	0.070	0.087	0.103	0.107	0.111	0.135	0.159	
					RPM	2785	2501	2188	1945	1671	1592	1401	1251	1094	
	FEED	409	450	460	508	516	511	466	506	522					
	23~24	Aluminum-cast, alloyed	1.0D	0.5D	Vc	68	72	72	72	68	72	72	72	72	
					fz	0.049	0.060	0.070	0.087	0.103	0.107	0.111	0.135	0.159	
RPM					1810	1626	1422	1264	1086	1035	910	813	711		
FEED	266	293	299	330	336	332	303	329	339						

3 FLUTE ROUGHING - SIDE CUTTING

ISO	VDI 3323	Material Description	Ae	Ap	Parameter	Mill Diameter (Ø)									
						12.0	14.0	16.0	18.0	20.0	22.0	25.0	28.0	32.0	
N	21~22	Aluminum-wrought alloy	0.5D	1.5D	Vc	105	110	110	110	105	110	110	110	110	
					fz	0.065	0.080	0.095	0.116	0.137	0.143	0.149	0.180	0.212	
					RPM	2785	2501	2188	1945	1671	1592	1401	1251	1094	
	FEED	543	600	624	677	687	683	626	675	696					
	23~24	Aluminum-cast, alloyed	0.5D	1.5D	Vc	68	72	72	72	68	72	72	72	72	
					fz	0.065	0.080	0.095	0.116	0.137	0.143	0.149	0.180	0.212	
RPM					1810	1626	1422	1264	1086	1035	910	813	711		
FEED	353	390	405	440	446	444	407	439	452						

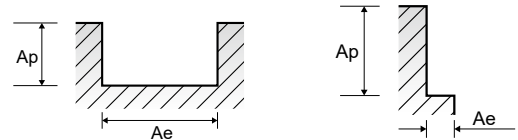



Leading Through Innovation



SOLID CARBIDE

D-POWER GRAPHITE END MILLS

D - POWER Graphit VHM - Fräser

- For Graphites
- Für Graphite

SELECTION GUIDE

HSS



SERIES	EI997	EIB93	EI880
FLUTE	2	2	2
HELIX ANGLE	30°	30°	30°
CUTTING EDGE SHAPE	BALL NOSE	BALL NOSE	BALL NOSE
SIZE MIN	R0.1	R0.2	R1.0
SIZE MAX	R3.0	R2.0	R6.0
PAGE	502	504	505

CBN END MILLS

i-Xmill END MILLS

i-SMART MODULAR END MILLS

X5070 END MILLS

4G MILL END MILLS

X-POWER PRO END MILLS

TitaNox-POWER END MILLS

JET-POWER END MILLS

V7 PLUS END MILLS

ALU-POWER HPC END MILLS

ALU-POWER END MILLS

D-POWER GRAPHITE END MILLS

D-POWER CFRP END MILLS

ROUTERS

CRX S END MILLS

K-2 END MILLS

ONLY ONE COATED PM60 END MILLS

TANK-POWER END MILLS

GENERAL HSS END MILLS

MILLING CUTTERS

TECHNICAL DATA

SOLID CARBIDE
D-POWER
for GRAPHITE
END MILLS

High performance on graphite



Please visit globalyg1.com/mat for material search

◎ : Excellent ○ : Good

Recommended cutting conditions : P 517

MINIATURE NECK	MINIATURE NECK	SHORT LENGTH NECK
Diamond	Diamond	Diamond



ISO	VDI 3323	Material Description	Composition / Structure / Heat Treatment	HB	HRc
P	1	Non-alloy steel	About 0.15% C Annealed	125	
	2		About 0.45% C Annealed	190	13
	3		About 0.45% C Quenched & Tempered	250	25
	4		About 0.75% C Annealed	270	28
	5		About 0.75% C Quenched & Tempered	300	32
	6	Low alloy steel	Annealed	180	10
	7		Quenched & Tempered	275	29
	8		Quenched & Tempered	300	32
	9		Quenched & Tempered	350	38
	10		High alloyed steel, and tool steel	Annealed	200
	11	Quenched & Tempered		325	35
M	12	Stainless steel	Ferritic / Martensitic Annealed	200	15
	13		Martensitic Quenched & Tempered	240	23
	14		Austenitic	180	10
K	15	Grey cast iron	Pearlitic / ferritic	180	10
	16		Pearlitic (Martensitic)	260	26
	17	Nodular cast iron	Ferritic	160	3
	18		Pearlitic	250	25
	19	Malleable cast iron	Ferritic	130	
	20		Pearlitic	230	21
N	21	Aluminum-wrought alloy	Not Curable	60	
	22		Curable Hardened	100	
	23	Aluminum-cast, alloyed	≤ 12% Si, Not Curable	75	
	24		≤ 12% Si, Curable Hardened	90	
	25		> 12% Si, Not Curable	130	
	26		Cutting Alloys, PB>1%	110	
	27	Copper and Copper Alloys (Bronze / Brass)	CuZn, CuSnZn (Brass)	90	
	28		CuSn, lead-free copper and electrolytic copper	100	
	29.1	Non Metallic Materials	Duroplastic, Fiber Reinforced Plastic		
	29.2		Graphite		
29.3	CFRP, GFRP				
30	Rubber, Wood, etc.				
S	31	Heat Resistant Super Alloys	Fe Based Annealed	200	15
	32		Cured	280	30
	33		Annealed	250	25
	34		Ni or Co Based Cured	350	38
	35		Cast	320	34
	36	Titanium Alloys	Pure Titanium	400 Rm	
	37		Alpha + Beta Alloys Hardened	1050 Rm	
H	38	Hardened steel	Hardened	550	55
	39		Hardened	630	60
	40	Chilled Cast Iron	Cast	400	42
	41	Hardened Cast Iron	Hardened	550	55

EI451	EI450	EIB87	EI881	EI996	EIB86	EIA13	EIA14	EIB88	EIB04
2	2	2	3	2	2	3	3	4	2
30°	30°	30°	30°	30°	30°	40°	40°	30°	30°
BALL NOSE	BALL NOSE	BALL NOSE	BALL NOSE	CORNER RADIUS	CORNER RADIUS	CORNER RADIUS	CORNER RADIUS	CORNER RADIUS	SQUARE
R1.0	R1.0	R0.5	R1.0	D0.2	D1.0	D2.0	D2.0	D6.0	D0.5
R6.0	R6.0	R1.0	R6.0	D6.0	D2.0	D12.0	D12.0	D12.0	D12.0
506	507	508	509	510	512	513	514	515	516
LONG LENGTH NECK	LONG REACH NECK	TAPER NECK	SHORT LENGTH NECK	MINIATURE NECK	TAPER NECK	SHORT LENGTH	LONG LENGTH	NECK	LONG LENGTH NECK
Diamond	Diamond	Diamond	Diamond	Diamond	Diamond	Diamond	Diamond	Diamond	Diamond

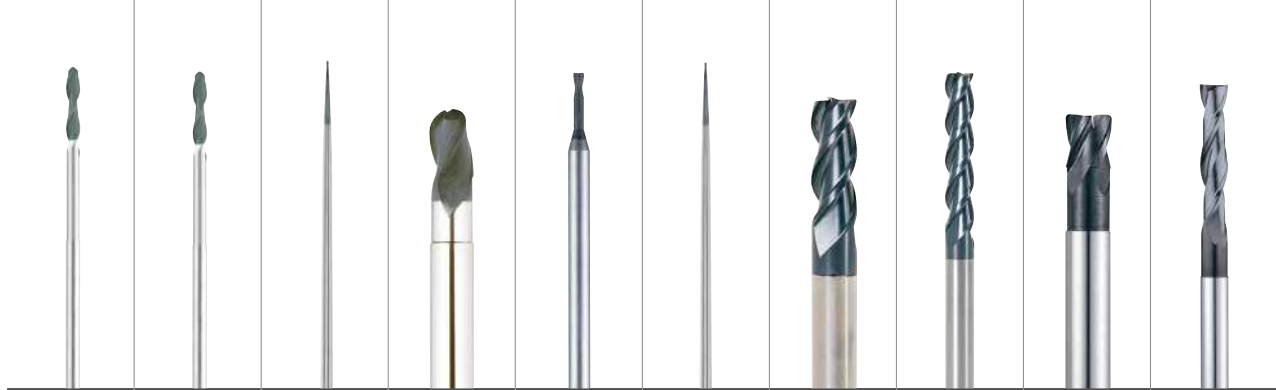

										1
										2
										3
										4
										5
										6 P
										7
										8
										9
										10
										11
										12
										13 M
										14
										15
										16
										17 K
										18
										19
										20
○	○	○	○	○	○	○	○	○	○	21
○	○	○	○	○	○	○	○	○	○	22
○	○	○	○	○	○	○	○	○	○	23
○	○	○	○	○	○	○	○	○	○	24
○	○	○	○	○	○	○	○	○	○	25
										26
										27 N
										28
										29
◎	◎	◎	◎	◎	◎	◎	◎	◎	◎	291
										292
										293
										30
										31
										32
										33
										34 S
										35
										36
										37
										38
										39
										40 H
										41

HSS

CBN END MILLS

i-Xmill END MILLS

i-SMART MODULAR END MILLS

X5070 END MILLS

4G MILL END MILLS

X-POWER PRO END MILLS

TitaNox-POWER END MILLS

JET-POWER END MILLS

V7 PLUS END MILLS

ALU-POWER HPC END MILLS

ALU-POWER END MILLS

D-POWER GRAPHITE END MILLS

D-POWER CFRP END MILLS

ROUTERS

CRX S END MILLS

K-2 END MILLS

ONLY ONE COATED PM60 END MILLS

TANK-POWER END MILLS

GENERAL HSS END MILLS

MILLING CUTTERS

TECHNICAL DATA



CARBIDE, 2 FLUTE MINIATURE BALL NOSE with NECK

- **VOLLHARTMETALL, 2 SCHNEIDEN MINI STIRNRADIUS mit ABGESETZTEM SCHAFTTETL**
- **Fraise carbure, 2 dents, hémisphérique, détalonnée, micro-fraise**
- **2 TAGLIENTI, SEMISFERICA, SERIE MINI, SCARICATA**

- ▶ Higher hardness of film and excellent wear-resistance increase the tool life surprisingly.
- ▶ Ultra fine film of YG-1's diamond coated carbide ball end mills ensure the smooth and excellent surface on work materials.
- ▶ High performance on graphite, wrought aluminum, bakelite, plastics, wood, brass etc. YG-1's diamond coated carbide ball end mills have good result for the machining of non-ferrous metals and non-metallic materials.

- ▶ **Höhere Härte der Beschichtung und ausgezeichnete Verschleißfestigkeit verlängern die Standzeit beachtlich.**
- ▶ **Ultrafeiner Film auf YG-1 Diamant - beschichteten Hartmetall Schaftfräser gewährleisten eine glatte und ausgezeichnete Oberflächengüte.**
- ▶ **Hohe Leistungsfähigkeit bei Graphit, Aluminium ohne Silicon, Bakelit, Plastik, Holz, Messing, etc. YG-1 Diamant - beschichtete Hartmetall Schaftfräser zeigen gute Ergebnisse beim Bearbeiten von NE - Metallen und Nichtmetall - Werkstoffen.**

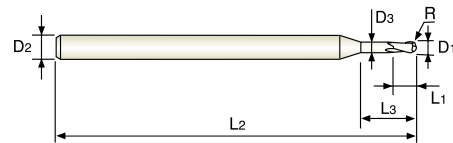

Unit : mm

EDP No.	Radius of Ball Nose	Mill Diameter	Shank Diameter	Length of Cut	Length Below Shank	Overall Length	Neck Diameter
	R (±0.01)	D1	D2	L1	L3	L2	D3
EI997002000040	R0.1	0.2	3	0.2	-	40	-
EI997003000040	R0.15	0.3	3	0.3	-	40	-
EI997004000040	R0.2	0.4	3	0.4	-	40	-
EI997005025040	R0.25	0.5	3	0.5	2.5	40	0.45
EI997006	R0.3	0.6	3	0.6	3	40	0.55
EI997006050040	R0.3	0.6	3	0.6	5	40	0.55
EI997008	R0.4	0.8	3	0.8	4	40	0.75
EI997008070040	R0.4	0.8	3	0.8	7	40	0.75
EI997010	R0.5	1.0	3	1	5	40	0.95
EI997903	R0.5	1.0	3	1	8.5	40	0.95
EI997010120040	R0.5	1.0	3	1	12	40	0.95
EI997012	R0.6	1.2	3	1.2	6	50	1.15
EI997012100050	R0.6	1.2	3	1.2	10	50	1.15
EI997015	R0.75	1.5	3	1.5	7.5	50	1.4
EI997906	R0.75	1.5	3	1.5	12	50	1.4
EI997015180050	R0.75	1.5	3	1.5	18	50	1.4
EI997020	R1.0	2.0	3	2.2	10	60	1.9
EI997908	R1.0	2.0	3	2.2	16	60	1.9
EI997020250060	R1.0	2.0	3	2.2	25	60	1.9
EI997030100065	R1.5	3.0	4	3	10	65	2.9
EI997030150065	R1.5	3.0	4	3	15	65	2.9
EI997030200065	R1.5	3.0	4	3	20	65	2.9
EI997030250075	R1.5	3.0	4	3	25	75	2.9
EI997030300075	R1.5	3.0	4	3	30	75	2.9

▶ NEXT PAGE

Mill Dia. Tolerance (mm)	Shank Dia. Tolerance
0 ~ - 0.02	h5

◎ : Excellent ○ : Good

ISO Material Description	P										M				K						
	Non-alloy steel					Low alloy steel					High alloyed steel, and tool steel				Stainless steel		Grey cast iron		Nodular cast iron		Malleable cast iron
VDI 3323	1	2	3	4	5	6	7	8	9	10	11	12	13	14	15	16	17	18	19	20	
HRc		13	25	28	32	10	29	32	38	15	35	15	23	10	10	26	3	25		21	
HB	125	190	250	270	300	180	275	300	350	200	325	200	240	180	180	260	160	250	130	230	
Recommend																					
ISO Material Description	N										S							H			
	Aluminum-wrought alloy		Aluminum-cast, alloyed			Copper and Copper Alloys (Bronze / Brass)			Non Metallic Materials		Heat Resistant Super Alloys					Titanium Alloys		Hardened steel	Chilled Cast Iron	Hardened Cast Iron	
VDI 3323	21	22	23	24	25	26	27	28	29	30	31	32	33	34	35	36	37	38	39	40	41
HRc											15	30	25	38	34			55	60	42	55
HB	60	100	75	90	130	110	90	100			200	280	250	350	320	400 Rm	1050 Rm	550	630	400	550
Recommend	○	○	○	○	○				◎												

CARBIDE, 2 FLUTE MINIATURE BALL NOSE with NECK
 ● VOLLHARTMETALL, 2 SCHNEIDEN MINI STIRNRADIUS mit ABGESETZTEM SCHAFTTETL
 () Fraise carbure, 2 dents, hémisphérique, détalonnée, micro-fraise
 () 2 TAGLIANTI, SEMISFERICA, SERIE MINI, SCARICATA

- ▶ Higher hardness of film and excellent wear-resistance increase the tool life surprisingly.
- ▶ Ultra fine film of YG-1's diamond coated carbide ball end mills ensure the smooth and excellent surface on work materials.
- ▶ High performance on graphite, wrought aluminum, bakelite, plastics, wood, brass etc. YG-1's diamond coated carbide ball end mills have good result for the machining of non-ferrous metals and non-metallic materials.

- ▶ Höhere Härte der Beschichtung und ausgezeichnete Verschleißfestigkeit verlängern die Standzeit beachtlich.
- ▶ Ultrafeiner Film auf YG-1 Diamant - beschichteten Hartmetall Schaffräser gewährleisten eine glatte und ausgezeichnete Oberflächengüte.
- ▶ Hohe Leistungsfähigkeit bei Graphit, Aluminium ohne Silicon, Bakelit, Plastik, Holz, Messing, etc. YG-1 Diamant - beschichtete Hartmetall Schaffräser zeigen gute Ergebnisse beim Bearbeiten von NE - Metallen und Nichtmetall - Werkstoffen.

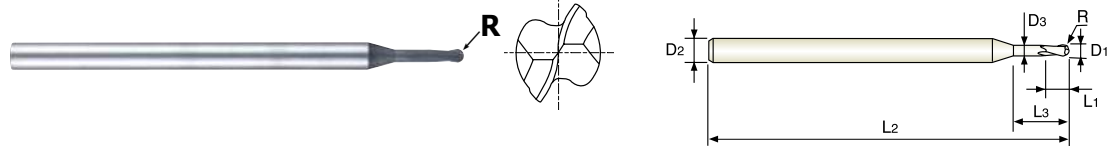

CARBIDE 2 30° ±0.01 PLAIN P.517

Unit : mm

EDP No.	Radius of Ball Nose	Mill Diameter	Shank Diameter	Length of Cut	Length Below Shank	Overall Length	Neck Diameter
	R (±0.01)	D1	D2	L1	L3	L2	D3
EI997040200065	R2.0	4.0	6	4	20	65	3.9
EI997040300075	R2.0	4.0	6	4	30	75	3.9
EI997040400090	R2.0	4.0	6	4	40	90	3.9
EI997050200065	R2.5	5.0	6	5	20	65	4.9
EI997050300075	R2.5	5.0	6	5	30	75	4.9
EI997050400090	R2.5	5.0	6	5	40	90	4.9
EI997050500090	R2.5	5.0	6	5	50	90	4.9
EI997060300075	R3.0	6.0	6	6	30	75	5.9
EI997060400090	R3.0	6.0	6	6	40	90	5.9
EI997060500090	R3.0	6.0	6	6	50	90	5.9
EI997060600100	R3.0	6.0	6	6	60	100	5.9

Mill Dia. Tolerance (mm)	Shank Dia. Tolerance
0 ~ - 0.02	h5

◎ : Excellent ○ : Good

ISO Material Description	P										M				K						
	Non-alloy steel					Low alloy steel					High alloyed steel, and tool steel				Stainless steel		Grey cast iron		Nodular cast iron		Malleable cast iron
VDI 3323	1	2	3	4	5	6	7	8	9	10	11	12	13	14	15	16	17	18	19	20	
HRC	13	25	28	32	10	29	32	38	15	35	15	23	10	10	26	3	25	25	21		
HB	125	190	250	270	300	180	275	300	350	200	325	200	240	180	180	260	160	250	130	230	
Recommend																					
ISO Material Description	N					S					H										
	Aluminum-wrought alloy		Aluminum-cast, alloyed			Copper and Copper Alloys (Bronze / Brass)			Non Metallic Materials		Heat Resistant Super Alloys					Titanium Alloys		Hardened steel	Chilled Cast Iron	Hardened Cast Iron	
VDI 3323	21	22	23	24	25	26	27	28	29	30	31	32	33	34	35	36	37	38	39	40	41
HRC	60	100	75	90	130	110	90	100			15	30	25	38	34	200	280	250	350	400 Rm	1050 Rm
HB	60	100	75	90	130	110	90	100			200	280	250	350	320	400 Rm	1050 Rm	550	630	400	550
Recommend	○	○	○	○	○				◎												



CARBIDE, 2 FLUTE MINIATURE BALL NOSE with NECK

- **VOLLHARTMETALL, 2 SCHNEIDEN MINI STIRNRADIUS mit ABGESETZTEM SCHAFTTETL**
- **Fraise carbure, 2 dents, hémisphérique, détalonnée, micro-fraise**
- **2 TAGLIENTI, SEMISFERICA, SERIE MINI, SCARICATA**

- ▶ Higher hardness of film and excellent wear-resistance increase the tool life surprisingly.
- ▶ Ultra fine film of YG-1's diamond coated carbide ball end mills ensure the smooth and excellent surface on work materials.
- ▶ High performance on graphite, wrought aluminum, bakelite, plastics, wood, brass etc. YG-1's diamond coated carbide ball end mills have good result for the machining of non-ferrous metals and non-metallic materials.

- ▶ Höhere Härte der Beschichtung und ausgezeichnete Verschleißfestigkeit verlängern die Standzeit beachtlich.
- ▶ Ultrafeiner Film auf YG-1 Diamant - beschichteten Hartmetall Schaftfräser gewährleisten eine glatte und ausgezeichnete Oberflächengüte.
- ▶ Hohe Leistungsfähigkeit bei Graphit, Aluminium ohne Silicon, Bakelit, Plastik, Holz, Messing, etc. YG-1 Diamant - beschichtete Hartmetall Schaftfräser zeigen gute Ergebnisse beim Bearbeiten von NE - Metallen und Nichtmetall - Werkstoffen.

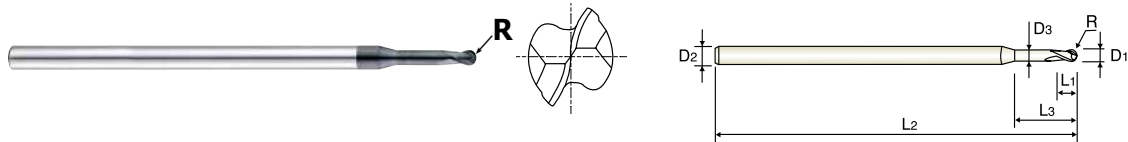

Unit : mm

EDP No.	Radius of Ball Nose	Mill Diameter	Shank Diameter	Length of Cut	Length Below Shank	Overall Length	Neck Diameter
	R (±0.01)	D1	D2	L1	L3	L2	D3
EIB93004040	R0.2	0.4	4	0.6	4	45	0.36
EIB93004060	R0.2	0.4	4	0.6	6	45	0.36
EIB93006040	R0.3	0.6	4	1	4	45	0.56
EIB93006060	R0.3	0.6	4	1	6	45	0.56
EIB93006080	R0.3	0.6	4	1	8	45	0.56
EIB93010060	R0.5	1.0	4	1.5	6	45	0.95
EIB93010080	R0.5	1.0	4	1.5	8	45	0.95
EIB93010120	R0.5	1.0	4	1.5	12	45	0.95
EIB93015120	R0.75	1.5	4	1.75	12	45	1.45
EIB93020080	R1.0	2.0	4	3	8	60	1.95
EIB93020120	R1.0	2.0	4	3	12	60	1.95
EIB93020160	R1.0	2.0	4	3	16	60	1.95
EIB93040160	R2.0	4.0	4	6	16	60	3.9

Mill Dia. Tolerance (mm)	Shank Dia. Tolerance
0 ~ - 0.02	h5

◎ : Excellent ○ : Good

ISO Material Description	P											M			K						
	Non-alloy steel					Low alloy steel				High alloyed steel, and tool steel		Stainless steel			Grey cast iron		Nodular cast iron		Malleable cast iron		
VDI 3323	1	2	3	4	5	6	7	8	9	10	11	12	13	14	15	16	17	18	19	20	
HRc		13	25	28	32	10	29	32	38	15	35	15	23	10	10	26	3	25		21	
HB	125	190	250	270	300	180	275	300	350	200	325	200	240	180	180	260	160	250	130	230	
Recommend																					
ISO Material Description	N										S					H					
	Aluminum-wrought alloy		Aluminum-cast, alloyed			Copper and Copper Alloys (Bronze / Brass)			Non Metallic Materials		Heat Resistant Super Alloys					Titanium Alloys		Hardened steel	Chilled Cast Iron	Hardened Cast Iron	
VDI 3323	21	22	23	24	25	26	27	28	29	30	31	32	33	34	35	36	37	38	39	40	41
HRc											15	30	25	38	34			55	60	42	55
HB	60	100	75	90	130	110	90	100			200	280	250	350	320	400 Rm	1050 Rm	550	630	400	550
Recommend	○	○	○	○	○					◎											



CARBIDE, 2 FLUTE BALL NOSE SHORT LENGTH with NECK

● **VOLLHARTMETALL, 2 SCHNEIDEN STIRNRADIUS KURZ mit ABGESETZTEM SCHAFTTETEL**

⦿ **Fraise carbure, 2 dents, hémisphérique, détalonnée, courte**

🇮🇹 **2 TAGLIANTI, SEMISFERICA, SERIE CORTA, SCARICATA**

- ▶ Higher hardness of film and excellent wear-resistance increase the tool life surprisingly!
- ▶ Ultra fine film of YG-1's diamond coated carbide ball end mills ensure the smooth and excellent surface on work materials.
- ▶ High performance on graphite, wrought aluminum, bakelite, plastics, wood, brass etc. YG-1's diamond coated carbide ball end mills have good result for the machining of non-ferrous metals and non-metallic materials.

- ▶ Höhere Härte der Beschichtung und ausgezeichnete Verschleißfestigkeit verlängern die Standzeit beachtlich.
- ▶ Ultrafeiner Film auf YG-1 Diamant - beschichteten Hartmetall Schaffräser gewährleisten eine glatte und ausgezeichnete Oberflächengüte.
- ▶ Hohe Leistungsfähigkeit bei Graphit, Aluminium ohne Silicon, Bakelit, Plastik, Holz, Messing, etc. YG-1 Diamant - beschichtete Hartmetall Schaffräser zeigen gute Ergebnisse beim Bearbeiten von NE - Metallen und Nichtmetall - Werkstoffen.

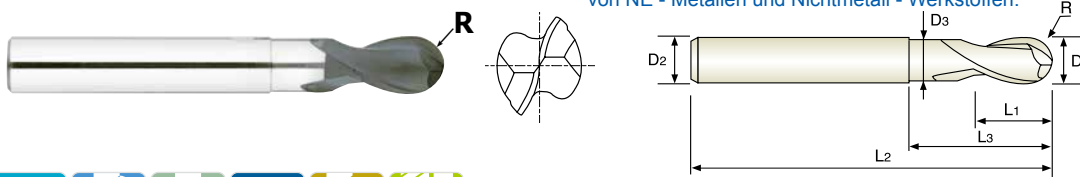

Unit : mm

EDP No.	Radius of Ball Nose	Mill Diameter	Shank Diameter	Length of Cut	Length Below Shank	Overall Length	Neck Diameter
	R (±0.01)	D1	D2	L1	L3	L2	D3
EI880020	R1.0	2.0	6	3	5	60	1.9
EI880025	R1.25	2.5	6	4	6	60	2.4
EI880030	R1.5	3.0	6	4.5	6.5	60	2.8
EI880035	R1.75	3.5	6	5	7	65	3.2
EI880040	R2.0	4.0	6	6	8	65	3.7
EI880050	R2.5	5.0	6	7.5	10	65	4.6
EI880060	R3.0	6.0	6	9	12	75	5.6
EI880080	R4.0	8.0	8	12	25	75	7.4
EI880100	R5.0	10.0	10	15	30	80	9.4
EI880120	R6.0	12.0	12	18	36	90	11.4

Mill Dia. Tolerance (mm)	Shank Dia. Tolerance
0 ~ - 0.03	h5

◎ : Excellent ○ : Good

ISO Material Description	P										M				K							
	Non-alloy steel					Low alloy steel					High alloyed steel, and tool steel				Stainless steel			Grey cast iron		Nodular cast iron		Malleable cast iron
VDI 3323	1	2	3	4	5	6	7	8	9	10	11	12	13	14	15	16	17	18	19	20		
HRC	13	25	28	32	10	29	32	38	15	35	15	23	10	10	26	3	25	21	21			
HB	125	190	250	270	300	180	275	300	350	200	325	200	240	180	180	260	160	250	130	230		
Recommend																						
ISO Material Description	N					S					H											
	Aluminum-wrought alloy		Aluminum-cast, alloyed			Copper and Copper Alloys (Bronze / Brass)			Non Metallic Materials		Heat Resistant Super Alloys					Titanium Alloys		Hardened steel	Chilled Cast Iron	Hardened Cast Iron		
VDI 3323	21	22	23	24	25	26	27	28	29	30	31	32	33	34	35	36	37	38	39	40	41	
HRC	60	100	75	90	130	110	90	100			15	30	25	38	34	55	60	42	55	42	55	
HB	60	100	75	90	130	110	90	100			200	280	250	350	320	400 Rm	1050 Rm	550	630	400	550	
Recommend	○	○	○	○	○				◎													



CARBIDE, 2 FLUTE BALL NOSE LONG LENGTH with NECK

- **VOLLHARTMETALL, 2 SCHNEIDEN STIRNRADIUS LANG mit ABGESETZTEM SCHAFTTETL**
- **Fraise carbure, 2 dents, hémisphérique, détalonnée, longue**
- **2 TAGLIENTI, SEMISFERICA, SERIE LUNGA**

- ▶ Higher hardness of film and excellent wear-resistance increase the tool life surprisingly.
- ▶ Ultra fine film of YG-1's diamond coated carbide ball end mills ensure the smooth and excellent surface on work materials.
- ▶ High performance on graphite, wrought aluminum, bakelite, plastics, wood, brass etc. YG-1's diamond coated carbide ball end mills have good result for the machining of non-ferrous metals and non-metallic materials.

- ▶ **Höhere Härte der Beschichtung und ausgezeichnete Verschleißfestigkeit verlängern die Standzeit beachtlich.**
- ▶ **Ultrafeiner Film auf YG-1 Diamant - beschichteten Hartmetall Schaftfräser gewährleisten eine glatte und ausgezeichnete Oberflächengüte.**
- ▶ **Hohe Leistungsfähigkeit bei Graphit, Aluminium ohne Silicon, Bakelit, Plastik, Holz, Messing, etc. YG-1 Diamant - beschichtete Hartmetall Schaftfräser zeigen gute Ergebnisse beim Bearbeiten von NE - Metallen und Nichtmetall - Werkstoffen.**

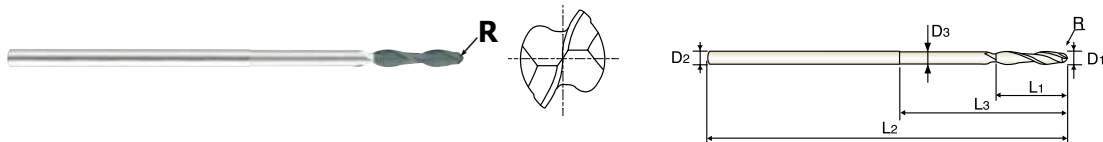

Unit : mm

EDP No.	Radius of Ball Nose	Mill Diameter	Shank Diameter	Length of Cut	Length Below Shank	Overall Length	Neck Diameter
	R (±0.01)	D1	D2	L1	L3	L2	D3
EI451020	R1.0	2.0	4	10	20	80	1.95
EI451030	R1.5	3.0	4	15	25	80	2.9
EI451040	R2.0	4.0	4	20	30	80	3.9
EI451050	R2.5	5.0	6	30	50	100	4.9
EI451060	R3.0	6.0	6	30	50	100	5.5
EI451070	R3.5	7.0	6	30	-	100	-
EI451080	R4.0	8.0	8	40	60	110	7.5
EI451090	R4.5	9.0	8	40	-	110	-
EI451100	R5.0	10.0	10	50	70	120	9.5
EI451120	R6.0	12.0	12	55	75	130	11.5

Mill Dia. Tolerance (mm)	Shank Dia. Tolerance
0 ~ - 0.03	h5

◎ : Excellent ○ : Good

ISO Material Description	P											M				K								
	Non-alloy steel					Low alloy steel						High alloyed steel, and tool steel				Stainless steel				Grey cast iron		Nodular cast iron		Malleable cast iron
VDI 3323	1	2	3	4	5	6	7	8	9	10	11	12	13	14	15	16	17	18	19	20				
HRc		13	25	28	32	10	29	32	38	15	35	15	23	10	10	26	3	25		21				
HB	125	190	250	270	300	180	275	300	350	200	325	200	240	180	180	260	160	250	130	230				
Recommend																								
ISO Material Description	N										S							H						
	Aluminum-wrought alloy		Aluminum-cast, alloyed			Copper and Copper Alloys (Bronze / Brass)			Non Metallic Materials		Heat Resistant Super Alloys							Titanium Alloys		Hardened steel	Chilled Cast Iron	Hardened Cast Iron		
VDI 3323	21	22	23	24	25	26	27	28	29	30	31	32	33	34	35	36	37	38	39	40	41			
HRc											15	30	25	38	34			55	60	42	55			
HB	60	100	75	90	130	110	90	100			200	280	250	350	320	400 Rm	1050 Rm	550	630	400	550			
Recommend	○	○	○	○	○					◎														



CARBIDE, 2 FLUTE BALL NOSE LONG REACH with NECK

- **VOLLHARTMETALL, 2 SCHNEIDEN STIRNRADIUS GROÖE REICHWEITE mit ABGESETZTEM SCHAFTTETL**
- **Fraise carbure, 2 dents, hémisphérique longue portée, détalonnée**
- **2 TAGLIANTI, SEMISFERICA PER CAVITA' PROFONDE**

- ▶ Higher hardness of film and excellent wear-resistance increase the tool life surprisingly.
- ▶ Ultra fine film of YG-1's diamond coated carbide ball end mills ensure the smooth and excellent surface on work materials.
- ▶ High performance on graphite, wrought aluminum, bakelite, plastics, wood, brass etc. YG-1's diamond coated carbide ball end mills have good result for the machining of non-ferrous metals and non-metallic materials.

- ▶ Höhere Härte der Beschichtung und ausgezeichnete Verschleißfestigkeit verlängern die Standzeit beachtlich.
- ▶ Ultrafeiner Film auf YG-1 Diamant - beschichteten Hartmetall Schauffräser gewährleisten eine glatte und ausgezeichnete Oberflächengüte.
- ▶ Hohe Leistungsfähigkeit bei Graphit, Aluminium ohne Silicon, Bakelit, Plastik, Holz, Messing, etc. YG-1 Diamant - beschichtete Hartmetall Schauffräser zeigen gute Ergebnisse beim Bearbeiten von NE - Metallen und Nichtmetall - Werkstoffen.

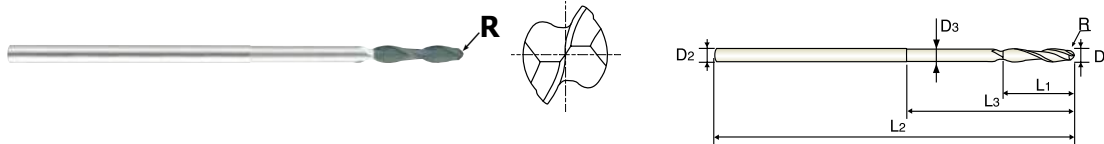

Unit : mm

EDP No.	Radius of Ball Nose	Mill Diameter	Shank Diameter	Length of Cut	Length Below Shank	Overall Length	Neck Diameter
	R (±0.01)	D1	D2	L1	L3	L2	D3
EI450020	R1.0	2.0	4	10	20	100	1.95
EI450030	R1.5	3.0	4	15	25	100	2.9
EI450040	R2.0	4.0	4	20	30	100	3.9
EI450050	R2.5	5.0	6	30	50	120	4.9
EI450060	R3.0	6.0	6	30	50	150	5.5
EI450070	R3.5	7.0	6	30	-	150	-
EI450080	R4.0	8.0	8	40	60	150	7.5
EI450090	R4.5	9.0	8	40	-	150	-
EI450100	R5.0	10.0	10	50	70	180	9.5
EI450120	R6.0	12.0	12	55	75	200	11.5

Mill Dia. Tolerance (mm)	Shank Dia. Tolerance
0 ~ - 0.03	h5

◎ : Excellent ○ : Good

ISO Material Description	P										M				K								
	Non-alloy steel					Low alloy steel					High alloyed steel, and tool steel				Stainless steel				Grey cast iron		Nodular cast iron		Malleable cast iron
VDI 3323	1	2	3	4	5	6	7	8	9	10	11	12	13	14	15	16	17	18	19	20			
HRC	13	25	28	32	10	29	32	38	15	35	15	23	10	10	26	3	25	25	21				
HB	125	190	250	270	300	180	275	300	350	200	325	200	240	180	180	260	160	250	130	230			
Recommend																							
ISO Material Description	N					S					H												
	Aluminum-wrought alloy		Aluminum-cast, alloyed			Copper and Copper Alloys (Bronze / Brass)			Non Metallic Materials		Heat Resistant Super Alloys					Titanium Alloys		Hardened steel	Chilled Cast Iron	Hardened Cast Iron			
VDI 3323	21	22	23	24	25	26	27	28	29	30	31	32	33	34	35	36	37	38	39	40	41		
HRC	60	100	75	90	130	110	90	100			15	30	25	38	34	200	280	250	350	320	400 Rm		
HB	60	100	75	90	130	110	90	100			200	280	250	350	320	400 Rm	1050 Rm	550	630	400	550		
Recommend	○	○	○	○	○				◎														



CARBIDE, 2 FLUTE BALL NOSE with TAPER NECK

- **VOLLHARTMETALL, 2 SCHNEIDEN STIRNRADIUS mit KONISCH ABGESETZTEM SCHAFTTEIL**
- **Fraise carbure, 2 dents, hémisphérique avec entrée conique**
- **2 TAGLIENTI, SEMISFERICA CON SCARICO CONICO**

- ▶ Higher hardness of film and excellent wear-resistance increase the tool life surprisingly.
- ▶ Ultra fine film of YG-1's diamond coated carbide ball end mills ensure the smooth and excellent surface on work materials.
- ▶ High performance on graphite, wrought aluminum, bakelite, plastics, wood, brass etc. YG-1's diamond coated carbide ball end mills have good result for the machining of non-ferrous metals and non-metallic materials.

- ▶ Höhere Härte der Beschichtung und ausgezeichnete Verschleißfestigkeit verlängern die Standzeit beachtlich.
- ▶ Ultrafeiner Film auf YG-1 Diamant - beschichteten Hartmetall Schaftfräser gewährleisten eine glatte und ausgezeichnete Oberflächengüte.
- ▶ Hohe Leistungsfähigkeit bei Graphit, Aluminium ohne Silicon, Bakelit, Plastik, Holz, Messing, etc. YG-1 Diamant - beschichtete Hartmetall Schaftfräser zeigen gute Ergebnisse beim Bearbeiten von NE - Metallen und Nichtmetall - Werkstoffen.

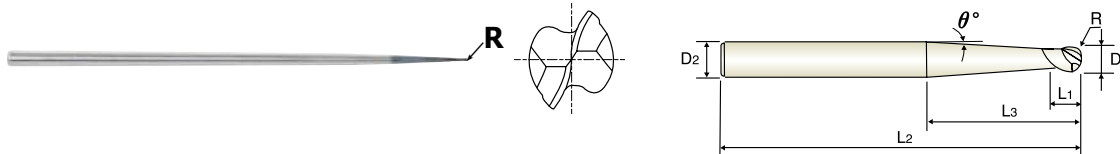

Unit : mm

EDP No.	Radius of Ball Nose	Mill Diameter	Shank Diameter	Length of Cut	Length Below Shank	Overall Length	Neck Taper Angle
	R (±0.01)	D1	D2	L1	L3	L2	θ°
EIB87010	R0.5	1.0	3	2	-	40	8° 30'
EIB87901	R0.5	1.0	3	2	30	60	2°
EIB87902	R0.5	1.0	3	2	70	100	1°
EIB87015	R0.75	1.5	3	3	-	40	6° 15'
EIB87903	R0.75	1.5	3	3	30	60	1° 30'
EIB87904	R0.75	1.5	3	3	58	100	45'
EIB87020	R1.0	2.0	3	4	-	40	4° 15'
EIB87905	R1.0	2.0	3	4	30	60	1°
EIB87906	R1.0	2.0	4	4	70	100	1°

Mill Dia. Tolerance (mm)	Shank Dia. Tolerance
0 ~ - 0.02	h5

◎ : Excellent ○ : Good

ISO Material Description	P											M			K						
	Non-alloy steel					Low alloy steel				High alloyed steel, and tool steel		Stainless steel			Grey cast iron		Nodular cast iron		Malleable cast iron		
VDI 3323	1	2	3	4	5	6	7	8	9	10	11	12	13	14	15	16	17	18	19	20	
HRc		13	25	28	32	10	29	32	38	15	35	15	23	10	10	26	3	25		21	
HB	125	190	250	270	300	180	275	300	350	200	325	200	240	180	180	260	160	250	130	230	
Recommend																					
ISO Material Description	N										S						H				
	Aluminum-wrought alloy		Aluminum-cast, alloyed			Copper and Copper Alloys (Bronze / Brass)			Non Metallic Materials		Heat Resistant Super Alloys						Titanium Alloys		Hardened steel	Chilled Cast Iron	Hardened Cast Iron
VDI 3323	21	22	23	24	25	26	27	28	29	30	31	32	33	34	35	36	37	38	39	40	41
HRc											15	30	25	38	34			55	60	42	55
HB	60	100	75	90	130	110	90	100			200	280	250	350	320	400 Rm	1050 Rm	550	630	400	550
Recommend	○	○	○	○	○					◎											

CARBIDE, 3 FLUTE BALL NOSE SHORT LENGTH with NECK

- **VOLLHARTMETALL, 3 SCHNEIDEN STIRNRADIUS KURZ mit ABGESETZTEM SCHAFTTETL**
- **Fraise carbure, 3 dents, hémisphérique, détalonnée, courte**
- **3 TAGLIANTI, SEMISFERICA, SERIE CORTA**

- ▶ Higher hardness of film and excellent wear-resistance increase the tool life surprisingly.
- ▶ Ultra fine film of YG-1's diamond coated carbide ball end mills ensure the smooth and excellent surface on work materials.
- ▶ High performance on graphite, wrought aluminum, bakelite, plastics, wood, brass etc. YG-1's diamond coated carbide ball end mills have good result for the machining of non-ferrous metals and non-metallic materials.

- ▶ Höhere Härte der Beschichtung und ausgezeichnete Verschleißfestigkeit verlängern die Standzeit beachtlich.
- ▶ Ultrafeiner Film auf YG-1 Diamant - beschichteten Hartmetall Schaftfräser gewährleisten eine glatte und ausgezeichnete Oberflächengüte.
- ▶ Hohe Leistungsfähigkeit bei Graphit, Aluminium ohne Silicon, Bakelit, Plastik, Holz, Messing, etc. YG-1 Diamant - beschichtete Hartmetall Schaftfräser zeigen gute Ergebnisse beim Bearbeiten von NE - Metallen und Nichtmetall - Werkstoffen.

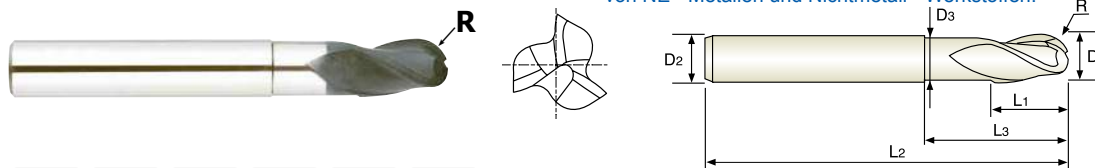

Unit : mm

EDP No.	Radius of Ball Nose	Mill Diameter	Shank Diameter	Length of Cut	Length Below Shank	Overall Length	Neck Diameter
	R (±0.01)	D1	D2	L1	L3	L2	D3
EI881020	R1.0	2.0	6	3	5	60	1.9
EI881025	R1.25	2.5	6	4	6	60	2.4
EI881030	R1.5	3.0	6	4.5	6.5	60	2.8
EI881035	R1.75	3.5	6	5	7	65	3.2
EI881040	R2.0	4.0	6	6	8	65	3.7
EI881050	R2.5	5.0	6	7.5	10	65	4.6
EI881060	R3.0	6.0	6	9	12	75	5.6
EI881080	R4.0	8.0	8	12	25	75	7.4
EI881100	R5.0	10.0	10	15	30	80	9.4
EI881120	R6.0	12.0	12	18	36	90	11.4

Mill Dia. Tolerance (mm)	Shank Dia. Tolerance
0 ~ - 0.03	h5

◎ : Excellent ○ : Good

ISO Material Description	P										M				K							
	Non-alloy steel					Low alloy steel					High alloyed steel, and tool steel				Stainless steel			Grey cast iron		Nodular cast iron		Malleable cast iron
VDI 3323	1	2	3	4	5	6	7	8	9	10	11	12	13	14	15	16	17	18	19	20		
HRc	13	25	28	32	10	29	32	38	15	35	15	23	10	10	26	3	25	21	21			
HB	125	190	250	270	300	180	275	300	350	200	325	200	240	180	180	260	160	250	130	230		
Recommend																						
ISO Material Description	N					S					H											
	Aluminum-wrought alloy		Aluminum-cast, alloyed			Copper and Copper Alloys (Bronze / Brass)			Non Metallic Materials		Heat Resistant Super Alloys					Titanium Alloys		Hardened steel	Chilled Cast Iron	Hardened Cast Iron		
VDI 3323	21	22	23	24	25	26	27	28	29	30	31	32	33	34	35	36	37	38	39	40	41	
HRc	60	100	75	90	130	110	90	100			15	30	25	38	34	55	60	42	55	55	55	
HB	60	100	75	90	130	110	90	100			200	280	250	350	320	400 Rm	1050 Rm	550	630	400	550	
Recommend	○	○	○	○	○				◎													

CARBIDE, 2 FLUTE MINIATURE CORNER RADIUS with NECK

VOLLHARTMETALL, 2 SCHNEIDEN MINI ECKENRADIUS mit ABGESETZTEM SCHAFTTETL
Fraise carbure, 2 dents, torique, détalonnée, micro-fraise
2 TAGLIENTI, TORICA, SERIE MINI, SCARICATA

- ▶ Higher hardness of film and excellent wear-resistance increase the tool life surprisingly.
- ▶ Ultra fine film of YG-1's diamond coated carbide end mills ensure the smooth and excellent surface on work materials.
- ▶ High performance on graphite, wrought aluminum, bakelite, plastics, wood, brass etc. YG-1's diamond coated carbide end mills have good result for the machining of non-ferrous metals and non-metallic materials.
- ▶ Höhere Härte der Beschichtung und ausgezeichnete Verschleißfestigkeit verlängern die Standzeit beachtlich.
- ▶ Ultrafeiner Film auf YG-1 Diamant - beschichteten Hartmetall Schaftfräser gewährleisten eine glatte und ausgezeichnete Oberflächengüte.
- ▶ Hohe Leistungsfähigkeit bei Graphit, Aluminium ohne Silicon, Bakelit, Plastik, Holz, Messing, etc. YG-1 Diamant - Beschichtete Hartmetall Schaftfräser zeigen gute Ergebnisse beim Bearbeiten von NE - Metallen und Nichtmetall - Werkstoffen.

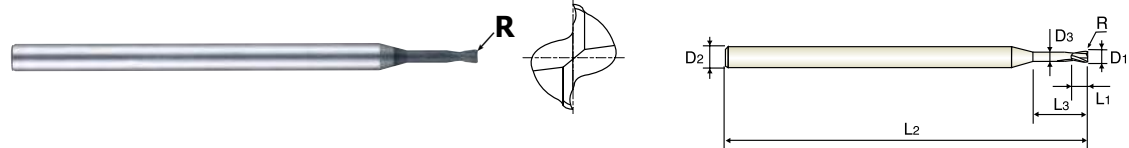

Unit : mm

EDP No.	Corner Radius	Mill Diameter	Shank Diameter	Length of Cut	Length Below Shank	Overall Length	Neck Diameter
	R	D1	D2	L1	L3	L2	D3
EI99600200000	-	0.2	3	0.3	-	40	-
EI99600300000	-	0.3	3	0.5	-	40	-
EI99600400000	-	0.4	3	0.6	-	40	-
EI99600505025	R0.05	0.5	3	0.7	2.5	40	0.45
EI99600505040	R0.05	0.5	3	0.7	4	40	0.45
EI996006	R0.05	0.6	3	0.9	3	40	0.55
EI99600605050	R0.05	0.6	3	0.9	5	40	0.55
EI996008	R0.05	0.8	3	1.2	4	40	0.75
EI99600805070	R0.05	0.8	3	1.2	7	40	0.75
EI996010	R0.1	1.0	3	1.5	5	40	0.95
EI996904	R0.1	1.0	3	1.5	8.5	40	0.95
EI99601010120	R0.1	1.0	3	1.5	12	40	0.95
EI996012	R0.1	1.2	3	1.8	6	50	1.15
EI99601210100	R0.1	1.2	3	1.8	10	50	1.15
EI996015	R0.15	1.5	3	2.2	7.5	50	1.4
EI996907	R0.15	1.5	3	2.2	12	50	1.4
EI99601515180	R0.15	1.5	3	2.2	18	50	1.4
EI996020	R0.15	2.0	3	2.2	10	60	1.9
EI996909	R0.15	2.0	3	2.2	16	60	1.9
EI99602015250	R0.15	2.0	3	2.2	25	60	1.9
EI99603020100	R0.2	3.0	4	3	10	65	2.9
EI99603020150	R0.2	3.0	4	3	15	65	2.9
EI99603020200	R0.2	3.0	4	3	20	65	2.9
EI99603020250	R0.2	3.0	4	3	25	75	2.9

Mill Dia. Tolerance (mm)	Shank Dia. Tolerance
0 ~ - 0.02	h5

▶ NEXT PAGE

◎ : Excellent ○ : Good

ISO Material Description	P											M				K					
	Non-alloy steel					Low alloy steel				High alloyed steel, and tool steel		Stainless steel				Grey cast iron		Nodular cast iron		Malleable cast iron	
VDI 3323	1	2	3	4	5	6	7	8	9	10	11	12	13	14	15	16	17	18	19	20	
HRc		13	25	28	32	10	29	32	38	15	35	15	23	10	10	26	3	25		21	
HB	125	190	250	270	300	180	275	300	350	200	325	200	240	180	180	260	160	250	130	230	
Recommend																					
ISO Material Description	N										S							H			
	Aluminum-wrought alloy		Aluminum-cast, alloyed			Copper and Copper Alloys (Bronze / Brass)			Non Metallic Materials		Heat Resistant Super Alloys					Titanium Alloys		Hardened steel	Chilled Cast Iron	Hardened Cast Iron	
VDI 3323	21	22	23	24	25	26	27	28	29	30	31	32	33	34	35	36	37	38	39	40	41
HRc											15	30	25	38	34			55	60	42	55
HB	60	100	75	90	130	110	90	100			200	280	250	350	320	400 Rm	1050 Rm	550	630	400	550
Recommend	○	○	○	○	○				◎												

CARBIDE, 2 FLUTE MINIATURE CORNER RADIUS with NECK

GERMANY VOLLHARTMETALL, 2 SCHNEIDEN MINI ECKENRADIUS mit ABGESETZTEM SCHAFTTETL
FRANCE Fraise carbure, 2 dents, torique, détalonnée, micro-fraise
ITALY 2 TAGLIENTI, TORICA, SERIE MINI, SCARICATA

- ▶ Higher hardness of film and excellent wear-resistance increase the tool life surprisingly.
- ▶ Ultra fine film of YG-1's diamond coated carbide end mills ensure the smooth and excellent surface on work materials.
- ▶ High performance on graphite, wrought aluminum, bakelite, plastics, wood, brass etc. YG-1's diamond coated carbide end mills have good result for the machining of non-ferrous metals and non-metallic materials.

- ▶ Höhere Härte der Beschichtung und ausgezeichnete Verschleißfestigkeit verlängern die Standzeit beachtlich.
- ▶ Ultrafeiner Film auf YG-1 Diamant - beschichteten Hartmetall Schaffräser gewährleisten eine glatte und ausgezeichnete Oberflächengüte.
- ▶ Hohe Leistungsfähigkeit bei Graphit, Aluminium ohne Silicon, Bakelit, Plastik, Holz, Messing, etc. YG-1 Diamant - beschichtete Hartmetall Schaffräser zeigen gute Ergebnisse beim Bearbeiten von NE - Metallen und Nichtmetall - Werkstoffen.

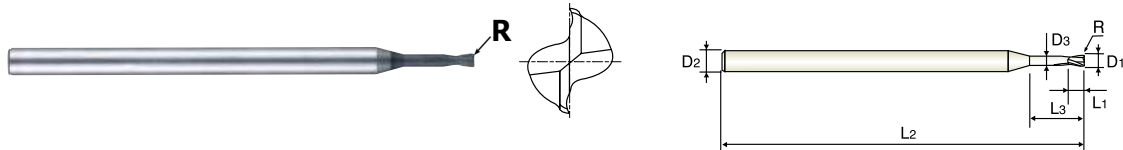

EDP No.	Corner Radius	Mill Diameter	Shank Diameter	Length of Cut	Length Below Shank	Overall Length	Neck Diameter
	R	D1	D2	L1	L3	L2	D3
E199603020300	R0.2	3.0	4	3	30	75	2.9
E199604020200	R0.2	4.0	6	4	20	65	3.9
E199604020300	R0.2	4.0	6	4	30	75	3.9
E199604020400	R0.2	4.0	6	4	40	90	3.9
E199605030200	R0.3	5.0	6	5	20	75	4.9
E199605030300	R0.3	5.0	6	5	30	75	4.9
E199605030400	R0.3	5.0	6	5	40	90	4.9
E199605030500	R0.3	5.0	6	5	50	90	4.9
E199606030300	R0.3	6.0	6	6	30	75	5.9
E199606030400	R0.3	6.0	6	6	40	90	5.9
E199606030500	R0.3	6.0	6	6	50	90	5.9
E199606030600	R0.3	6.0	6	6	60	100	5.9

Mill Dia. Tolerance (mm)	Shank Dia. Tolerance
0 ~ - 0.02	h5

◎ : Excellent ○ : Good

ISO Material Description	P										M				K								
	Non-alloy steel					Low alloy steel					High alloyed steel, and tool steel				Stainless steel				Grey cast iron		Nodular cast iron		Malleable cast iron
VDI 3323	1	2	3	4	5	6	7	8	9	10	11	12	13	14	15	16	17	18	19	20			
HRC	13	25	28	32	10	29	32	38	15	35	15	23	10	10	26	3	25	25	21				
HB	125	190	250	270	300	180	275	300	350	200	325	200	240	180	180	260	160	250	130	230			
Recommend																							

ISO Material Description	N					S					H										
	Aluminum-wrought alloy		Aluminum-cast, alloyed		Copper and Copper Alloys (Bronze / Brass)	Non Metallic Materials	Heat Resistant Super Alloys				Titanium Alloys		Hardened steel	Chilled Cast Iron	Hardened Cast Iron						
VDI 3323	21	22	23	24	25	26	27	28	29	30	31	32	33	34	35	36	37	38	39	40	41
HRC	60	100	75	90	130	110	90	100			15	30	25	38	34	55	60	55	60	42	55
HB	60	100	75	90	130	110	90	100			200	280	250	350	320	400 Rm	1050 Rm	550	630	400	550
Recommend	○	○	○	○	○				◎												

CARBIDE, 2 FLUTE CORNER RADIUS with TAPER NECK

- **VOLLHARTMETALL, 2 SCHEIDEN ECKENRADIUS mit KONISCH ABGESETZTEM SCHAFTTEIL**
- **Fraise carbure, 2 dents, torique avec entrée conique**
- **2 TAGLIENTI, TORICA CON SCARICO CONICO**

- ▶ Higher hardness of film and excellent wear-resistance increase the tool life surprisingly.
- ▶ Ultra fine film of YG-1's diamond coated carbide end mills ensure the smooth and excellent surface on work materials.
- ▶ High performance on graphite, wrought aluminum, bakelite, plastics, wood, brass etc. YG-1's diamond coated carbide end mills have good result for the machining of non-ferrous metals and non-metallic materials.

- ▶ Höhere Härte der Beschichtung und ausgezeichnete Verschleißfestigkeit verlängern die Standzeit beachtlich.
- ▶ Ultrafeiner Film auf YG-1 Diamant - beschichteten Hartmetall Schaftfräser gewährleisten eine glatte und ausgezeichnete Oberflächengüte.
- ▶ Hohe Leistungsfähigkeit bei Graphit, Aluminium ohne Silicon, Bakelit, Plastik, Holz, Messing, etc. YG-1 Diamant - beschichtete Hartmetall Schaftfräser zeigen gute Ergebnisse beim Bearbeiten von NE - Metallen und Nichtmetall - Werkstoffen.

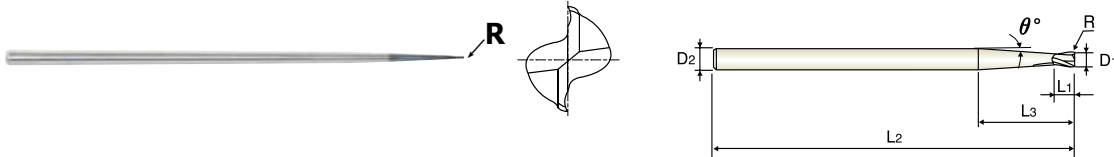

Unit : mm

EDP No.	Corner Radius	Mill Diameter	Shank Diameter	Length of Cut	Length Below Shank	Overall Length	Neck Taper Angle
	R	D1	D2	L1	L3	L2	θ°
EIB86010	R0.1	1.0	3	2	30	60	2°
EIB86901	R0.1	1.0	3	2	70	100	1°
EIB86015	R0.15	1.5	3	3	30	60	1° 30'
EIB86902	R0.15	1.5	3	3	50	100	1°
EIB86020	R0.15	2.0	3	4	30	60	1°
EIB86903	R0.15	2.0	4	4	70	100	1°

Mill Dia. Tolerance (mm)	Shank Dia. Tolerance
0 ~ - 0.02	h5

◎ : Excellent ○ : Good

ISO Material Description	P											M				K							
	Non-alloy steel					Low alloy steel						High alloyed steel, and tool steel				Stainless steel				Grey cast iron		Nodular cast iron	
VDI 3323	1	2	3	4	5	6	7	8	9	10	11	12	13	14	15	16	17	18	19	20			
HRc		13	25	28	32	10	29	32	38	15	35	15	23	10	10	26	3	25		21			
HB	125	190	250	270	300	180	275	300	350	200	325	200	240	180	180	260	160	250	130	230			
Recommend																							
ISO Material Description	N										S							H					
	Aluminum-wrought alloy		Aluminum-cast, alloyed			Copper and Copper Alloys (Bronze / Brass)			Non Metallic Materials		Heat Resistant Super Alloys							Titanium Alloys		Hardened steel	Chilled Cast Iron	Hardened Cast Iron	
VDI 3323	21	22	23	24	25	26	27	28	29	30	31	32	33	34	35	36	37	38	39	40	41		
HRc											15	30	25	38	34			55	60	42	55		
HB	60	100	75	90	130	110	90	100			200	280	250	350	320	400 Rm	1050 Rm	550	630	400	550		
Recommend	○	○	○	○	○				◎														

CARBIDE, 3 FLUTE 40° HELIX CORNER RADIUS SHORT LENGTH

● VOLLHARTMETALL, 3 SCHNEIDEN 40° RECHTSSPIRALE ECKENRADIUS KURZ

⦿ Fraise carbure, 3 dents, torique, hélice 40°, courte

🇮🇹 3 TAGLIANTI, ELICA 40°, TORICA, SERIE CORTA

- ▶ Higher hardness of film and excellent wear-resistance increase the tool life surprisingly.
- ▶ Ultra fine film of YG-1's diamond coated carbide end mills ensure the smooth and excellent surface on work materials.
- ▶ High performance on graphite, wrought aluminum, bakelite, plastics, wood, brass etc. YG-1's diamond coated carbide end mills have good result for the machining of non-ferrous metals and non-metallic materials.

- ▶ Höhere Härte der Beschichtung und ausgezeichnete Verschleißfestigkeit verlängern die Standzeit beachtlich.
- ▶ Ultrafeiner Film auf YG-1 Diamant - beschichteten Hartmetall Schaffräser gewährleisten eine glatte und ausgezeichnete Oberflächengüte.
- ▶ Hohe Leistungsfähigkeit bei Graphit, Aluminium ohne Silicon, Bakelit, Plastik, Holz, Messing, etc. YG-1 Diamant - beschichtete Hartmetall Schaffräser zeigen gute Ergebnisse beim Bearbeiten von NE - Metallen und Nichtmetall - Werkstoffen.

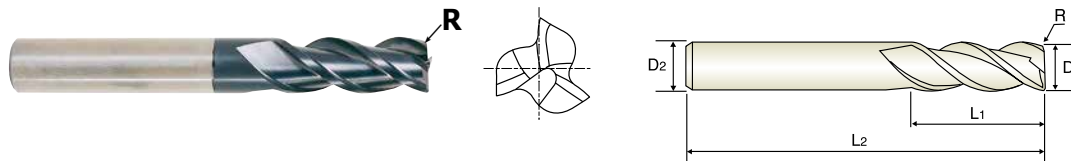

Unit : mm

EDP No.	Corner Radius	Mill Diameter	Shank Diameter	Length of Cut	Overall Length
	R	D1	D2	L1	L2
EIA13020	R0.15	2.0	3	6	40
EIA13030	R0.15	3.0	3	12	40
EIA13040	R0.2	4.0	4	14	50
EIA13050	R0.3	5.0	5	16	50
EIA13060	R0.3	6.0	6	20	65
EIA13080	R0.5	8.0	8	20	65
EIA13100	R0.5	10.0	10	25	75
EIA13120	R0.5	12.0	12	25	75

Mill Dia. Tolerance (mm)	Shank Dia. Tolerance
0 ~ - 0.03	h5

◎ : Excellent ○ : Good

ISO Material Description	P										M			K							
	Non-alloy steel					Low alloy steel					High alloyed steel, and tool steel			Stainless steel			Grey cast iron		Nodular cast iron		Malleable cast iron
VDI 3323	1	2	3	4	5	6	7	8	9	10	11	12	13	14	15	16	17	18	19	20	
HRc	13	13	25	28	32	10	29	32	38	15	35	15	23	10	10	26	3	25	42	21	
HB	125	190	250	270	300	180	275	300	350	200	325	200	240	180	180	260	160	250	130	230	
Recommend																					
ISO Material Description	N					S					H										
	Aluminum-wrought alloy		Aluminum-cast, alloyed			Copper and Copper Alloys (Bronze / Brass)			Non Metallic Materials		Heat Resistant Super Alloys					Titanium Alloys		Hardened steel	Chilled Cast Iron	Hardened Cast Iron	
VDI 3323	21	22	23	24	25	26	27	28	29	30	31	32	33	34	35	36	37	38	39	40	41
HRc	60	100	75	90	130	110	90	100			15	30	25	38	34	400 Rm	1050 Rm	55	60	42	55
HB	60	100	75	90	130	110	90	100			200	280	250	350	320	400 Rm	1050 Rm	550	630	400	550
Recommend	○	○	○	○	○				◎												



CARBIDE, 3 FLUTE 40° HELIX CORNER RADIUS LONG LENGTH

- **VOLLHARTMETALL, 3 SCHNEIDN 40° RECHTSSPIRALE ECKENRADIUS LANG**
- **Fraise carbure, 3 dents, torique, hélice 40°, longue**
- **3 TAGLIENTI, ELICA 40°, TORICA, SERIE LUNGA**

- ▶ Higher hardness of film and excellent wear-resistance increase the tool life surprisingly.
- ▶ Ultra fine film of YG-1's diamond coated carbide end mills ensure the smooth and excellent surface on work materials.
- ▶ High performance on graphite, wrought aluminum, bakelite, plastics, wood, brass etc. YG-1's diamond coated carbide end mills have good result for the machining of non-ferrous metals and non-metallic materials.
- ▶ **Höhere Härte der Beschichtung und ausgezeichnete Verschleißfestigkeit verlängern die Standzeit beachtlich.**
- ▶ **Ultrafeiner Film auf YG-1 Diamant - beschichteten Hartmetall Schafffräser gewährleisten eine glatte und ausgezeichnete Oberflächengüte.**
- ▶ **Hohe Leistungsfähigkeit bei Graphit, Aluminium ohne Silicon, Bakelit, Plastik, Holz, Messing, etc. YG-1 Diamant - beschichtete Hartmetall Schafffräser zeigen gute Ergebnisse beim Bearbeiten von NE - Metallen und Nichtmetall - Werkstoffen.**

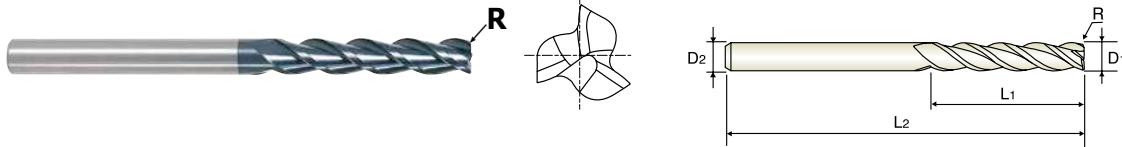

Unit : mm

EDP No.	Corner Radius	Mill Diameter	Shank Diameter	Length of Cut	Overall Length
	R	D1	D2	L1	L2
EIA14020	R0.15	2.0	3	9	60
EIA14030	R0.15	3.0	3	30	60
EIA14040	R0.2	4.0	4	30	60
EIA14050	R0.3	5.0	5	35	70
EIA14060	R0.3	6.0	6	40	100
EIA14080	R0.5	8.0	8	40	100
EIA14100	R0.5	10.0	10	40	100
EIA14120	R0.5	12.0	12	45	100

Mill Dia. Tolerance (mm)	Shank Dia. Tolerance
0 ~ - 0.03	h5

◎ : Excellent ○ : Good

ISO Material Description	P											M				K							
	Non-alloy steel					Low alloy steel						High alloyed steel, and tool steel				Stainless steel				Grey cast iron		Nodular cast iron	
VDI 3323	1	2	3	4	5	6	7	8	9	10	11	12	13	14	15	16	17	18	19	20			
HRc		13	25	28	32	10	29	32	38	15	35	15	23	10	10	26	3	25		21			
HB	125	190	250	270	300	180	275	300	350	200	325	200	240	180	180	260	160	250	130	230			
Recommend																							
ISO Material Description	N										S							H					
	Aluminum-wrought alloy		Aluminum-cast, alloyed			Copper and Copper Alloys (Bronze / Brass)			Non Metallic Materials		Heat Resistant Super Alloys							Titanium Alloys		Hardened steel	Chilled Cast Iron	Hardened Cast Iron	
VDI 3323	21	22	23	24	25	26	27	28	29	30	31	32	33	34	35	36	37	38	39	40	41		
HRc											15	30	25	38	34			55	60	42	55		
HB	60	100	75	90	130	110	90	100			200	280	250	350	320	400 Rm	1050 Rm	550	630	400	550		
Recommend	○	○	○	○	○					◎													

CARBIDE, 4 FLUTE CORNER RADIUS with NECK

- VOLLHARTMETALL, 4 SCHNEIDEN ECKENRADIUS mit ABGESETZTEM SCHAFTTETEL
- Fraise carbure, 4 dents, torique, détalonnée
- 4 TAGLIANTI, TORICA, SCARICATA

- ▶ Higher hardness of film and excellent wear-resistance increase the tool life surprisingly.
- ▶ Ultra fine film of YG-1's diamond coated carbide end mills ensure the smooth and excellent surface on work materials.
- ▶ High performance on graphite, wrought aluminum, bakelite, plastics, wood, brass etc. YG-1's diamond coated carbide end mills have good result for the machining of non-ferrous metals and non-metallic materials.

- ▶ Höhere Härte der Beschichtung und ausgezeichnete Verschleißfestigkeit verlängern die Standzeit beachtlich.
- ▶ Ultrafeiner Film auf YG-1 Diamant - beschichteten Hartmetall Schaffräser gewährleisten eine glatte und ausgezeichnete Oberflächengüte.
- ▶ Hohe Leistungsfähigkeit bei Graphit, Aluminium ohne Silicon, Bakelit, Plastik, Holz, Messing, etc. YG-1 Diamant - beschichtete Hartmetall Schaffräser zeigen gute Ergebnisse beim Bearbeiten von NE - Metallen und Nichtmetall - Werkstoffen.

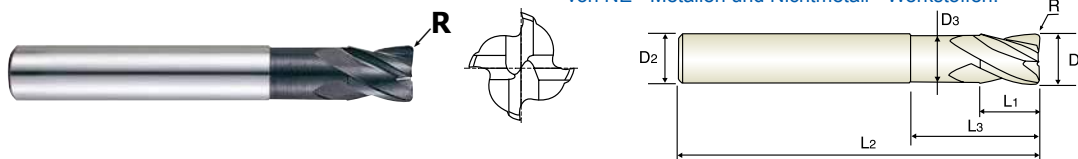

EDP No.	Corner Radius	Mill Diameter	Shank Diameter	Length of Cut	Length Below Shank	Overall Length	Neck Diameter
	R	D1	D2	L1	L3	L2	D3
EIB88060	R0.5	6.0	6	10	40	80	5.9
EIB88080	R0.5	8.0	8	10	40	80	7.8
EIB88901	R1.0	8.0	8	10	60	100	7.8
EIB88100	R0.5	10.0	10	25	-	75	-
EIB88902	R0.5	10.0	10	12	40	80	9.8
EIB88903	R1.0	10.0	10	12	40	80	9.8
EIB88904	R0.5	10.0	10	12	80	125	9.8
EIB88120	R0.5	12.0	12	25	-	80	-
EIB88905	R0.5	12.0	12	15	40	80	11.8
EIB88906	R1.0	12.0	12	15	40	80	11.8
EIB88907	R1.0	12.0	12	15	80	125	11.8

Mill Dia. Tolerance (mm)	Shank Dia. Tolerance
0 ~ - 0.03	h5

◎ : Excellent ○ : Good

ISO Material Description	P										M				K								
	Non-alloy steel					Low alloy steel					High alloyed steel, and tool steel				Stainless steel				Grey cast iron		Nodular cast iron		Malleable cast iron
VDI 3323	1	2	3	4	5	6	7	8	9	10	11	12	13	14	15	16	17	18	19	20			
HRc	13	25	28	32	10	29	32	38	15	35	15	23	10	10	26	3	25	25	21				
HB	125	190	250	270	300	180	275	300	350	200	325	200	240	180	180	260	160	250	130	230			
Recommend																							
ISO Material Description	N					S					H												
	Aluminum-wrought alloy		Aluminum-cast, alloyed			Copper and Copper Alloys (Bronze / Brass)			Non Metallic Materials		Heat Resistant Super Alloys					Titanium Alloys		Hardened steel	Chilled Cast Iron	Hardened Cast Iron			
VDI 3323	21	22	23	24	25	26	27	28	29	30	31	32	33	34	35	36	37	38	39	40	41		
HRc											15	30	25	38	34			55	60	42	55		
HB	60	100	75	90	130	110	90	100			200	280	250	350	320	400 Rm	1050 Rm	550	630	400	550		
Recommend	○	○	○	○	○				◎														



CARBIDE, 2 FLUTE LONG LENGTH with NECK

- **VOLLHARTMETALL, 2 SCHNEIDEN LANG mit ABGESETZTEM SCHAFTTETL**
- **Fraise carbure, 2 dents, détalonnée, longue**
- **2 TAGLIENTI, SERIE LUNGA**

- ▶ Higher hardness of film and excellent wear-resistance increase the tool life surprisingly.
- ▶ Ultra fine film of YG-1's diamond coated carbide end mills ensure the smooth and excellent surface on work materials.
- ▶ High performance on graphite, wrought aluminum, bakelite, plastics, wood, brass etc. YG-1's diamond coated carbide end mills have good result for the machining of non-ferrous metals and non-metallic materials.

- ▶ **Höhere Härte der Beschichtung und ausgezeichnete Verschleißfestigkeit verlängern die Standzeit beachtlich.**
- ▶ **Ultrafeiner Film auf YG-1 Diamant - beschichteten Hartmetall Schaffräser gewährleisten eine glatte und ausgezeichnete Oberflächengüte.**
- ▶ **Hohe Leistungsfähigkeit bei Graphit, Aluminium ohne Silicon, Bakelit, Plastik, Holz, Messing, etc. YG-1 Diamant - beschichtete Hartmetall Schaffräser zeigen gute Ergebnisse beim Bearbeiten von NE - Metallen und Nichtmetall - Werkstoffen.**

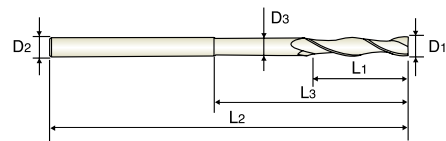
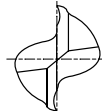

Unit : mm

EDP No.	Mill Diameter	Shank Diameter	Length of Cut	Length Below Shank	Overall Length	Neck Diameter
	D1	D2	L1	L3	L2	D3
EIB0400502040	0.5	3	1	2	40	0.45
EIB0400603040	0.6	3	2	3	40	0.55
EIB0400704040	0.7	3	2	4	40	0.65
EIB0400805040	0.8	3	2	5	40	0.75
EIB0400906040	0.9	3	2	6	40	0.85
EIB0401008075	1.0	4	3	8	75	0.95
EIB0401510075	1.5	4	4	10	75	1.45
EIB0402016100	2.0	4	6	16	100	1.9
EIB0402520100	2.5	4	8	20	100	2.4
EIB0403030100	3.0	6	8	30	100	2.8
EIB0403535100	3.5	6	10	35	100	3.2
EIB0404040100	4.0	6	20	40	100	3.7
EIB0405050125	5.0	6	25	50	125	4.6
EIB0406060140	6.0	6	30	60	140	5.6
EIB0407000140	7.0	6	35	-	140	-
EIB0408080150	8.0	8	40	80	150	7.4
EIB0409000150	9.0	8	45	-	150	-
EIB0410080150	10.0	10	50	80	150	9.4
EIB0411000150	11.0	10	50	-	150	-
EIB0412080150	12.0	12	55	80	150	11.4

Mill Dia. Tolerance (mm)	Shank Dia. Tolerance
0 ~ - 0.03	h5

◎ : Excellent ○ : Good

ISO Material Description	P											M				K								
	Non-alloy steel					Low alloy steel						High alloyed steel, and tool steel				Stainless steel				Grey cast iron		Nodular cast iron		Malleable cast iron
VDI 3323	1	2	3	4	5	6	7	8	9	10	11	12	13	14	15	16	17	18	19	20				
HRc	13	25	28	32	10	29	32	38	15	35	15	23	10	10	26	3	25							
HB	125	190	250	270	300	180	275	300	350	200	325	200	240	180	180	260	160	250	130	230				
Recommend																								
ISO Material Description	N										S							H						
	Aluminum-wrought alloy		Aluminum-cast, alloyed			Copper and Copper Alloys (Bronze / Brass)			Non Metallic Materials		Heat Resistant Super Alloys							Titanium Alloys		Hardened steel	Chilled Cast Iron	Hardened Cast Iron		
VDI 3323	21	22	23	24	25	26	27	28	29	30	31	32	33	34	35	36	37	38	39	40	41			
HRc											15	30	25	38	34			55	60	42	55			
HB	60	100	75	90	130	110	90	100			200	280	250	350	320	400 Rm	1050 Rm	550	630	400	550			
Recommend	○	○	○	○	○					◎														

Vc = m/min.
fz = mm/tooth
RPM = rev./min.
FEED = mm/min.

EI997, EIB93, EIB87 SERIES **2 FLUTE BALL NOSE**

ISO	VDI 3323	Material Description	Ae	Ap	Parameter	Diameter (Ø)										
						0.4	0.6	0.8	1.0	1.2	1.5	2.0	3.0	4.0	5.0	6.0
N	29.2	Graphite	0.2D	0.2D	Vc	50	75	100	125	150	190	250	255	250	265	
					fz	0.008	0.010	0.012	0.015	0.018	0.020	0.025	0.041	0.073	0.091	0.104
					RPM	39789	39789	39789	39789	39789	40319	39789	27056	19894	15915	14059
					FEED	637	796	955	1194	1432	1613	1989	2219	2905	2897	2924

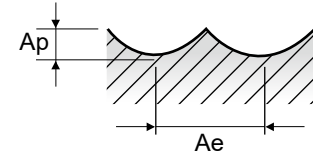

EI880, EI451, EI450 SERIES **2 FLUTE BALL NOSE**

ISO	VDI 3323	Material Description	Ae	Ap	Parameter	Diameter (Ø)									
						2.0	2.5	3.0	3.5	4.0	5.0	6.0	8.0	10.0	12.0
N	29.2	Graphite	0.2D	0.2D	Vc	100	125	150	175	200	245	285	325	360	395
					fz	0.025	0.035	0.045	0.055	0.066	0.082	0.098	0.115	0.133	0.150
					RPM	15915	15915	15915	15915	15915	15597	15120	12931	11459	10478
					FEED	796	1114	1432	1751	2101	2558	2963	2974	3048	3143

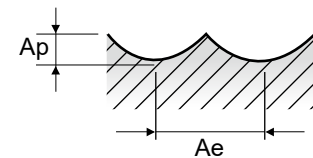

EI881 SERIES **3 FLUTE BALL NOSE**

ISO	VDI 3323	Material Description	Ae	Ap	Parameter	Diameter (Ø)									
						2.0	2.5	3.0	3.5	4.0	5.0	6.0	8.0	10.0	12.0
N	29.2	Graphite	0.2D	0.2D	Vc	100	125	150	175	200	245	285	325	360	395
					fz	0.025	0.035	0.045	0.055	0.065	0.082	0.099	0.115	0.133	0.151
					RPM	15915	15915	15915	15915	15915	15597	15120	12931	11459	10478
					FEED	1194	1671	2149	2626	3104	3837	4491	4461	4572	4746

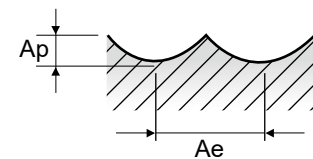

EI996, EIB86 SERIES **2 FLUTE CORNER RADIUS - SLOTTING**

ISO	VDI 3323	Material Description	Ae	Ap	Parameter	Diameter (Ø)										
						0.4	0.6	0.8	1.0	1.2	1.5	2.0	3.0	4.0	5.0	6.0
N	29.2	Graphite	1.0D	0.5D	Vc	50	75	100	125	150	190	250	255	250	265	
					fz	0.008	0.008	0.010	0.012	0.015	0.018	0.020	0.035	0.058	0.072	0.082
					RPM	39789	39789	39789	39789	39789	40319	39789	27056	19894	15915	14059
					FEED	637	637	796	955	1194	1451	1592	1894	2308	2292	2306

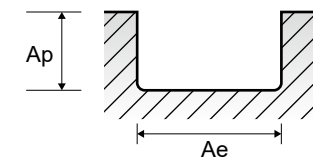



EIA13, EIA14 SERIES

3 FLUTE CORNER RADIUS - SIDE CUTTING

Vc = m/min.
fz = mm/tooth
RPM = rev./min.
FEED = mm/min.

ISO	VDI 3323	Material Description	Ae	Ap	Parameter	Diameter (Ø)							
						2.0	3.0	4.0	5.0	6.0	8.0	10.0	12.0
N	29.2	Graphite	0.3D	0.3D	Vc	250	375	505	630	755	805	815	790
					fz	0.025	0.035	0.05	0.06	0.07	0.088	0.11	0.13
					RPM	39789	39789	40187	40107	40054	32030	25942	20955
					FEED	2984	4178	6028	7219	8411	8456	8561	8173

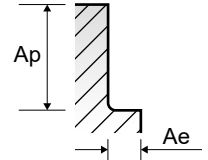

EIB88 SERIES

4 FLUTE CORNER RADIUS - SIDE CUTTING

ISO	VDI 3323	Material Description	Ae	Ap	Parameter	Diameter (Ø)			
						6.0	8.0	10.0	12.0
N	29.2	Graphite	0.3D	0.3D	Vc	755	805	815	790
					fz	0.035	0.044	0.055	0.065
					RPM	40054	32030	25942	20955
					FEED	5608	5637	5707	5448

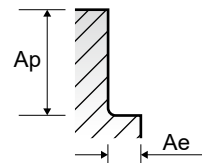

EIB04 SERIES

2 FLUTE - SIDE CUTTING

ISO	VDI 3323	Material Description	Ae	Ap	Parameter	Diameter (Ø)												
						0.4	0.6	0.8	1.0	1.5	2.0	3.0	4.0	5.0	6.0	8.0	10.0	12.0
N	29.2	Graphite	0.1D	1.5D	Vc	50	75	100	125	190	155	190	225	220	205	200	205	205
					fz	0.003	0.004	0.007	0.009	0.010	0.016	0.020	0.026	0.043	0.064	0.081	0.092	0.109
					RPM	39789	39789	39789	39789	40319	24669	20160	17905	14006	10876	7958	6525	5438
					FEED	239	318	557	716	806	789	806	931	1204	1392	1289	1201	1185

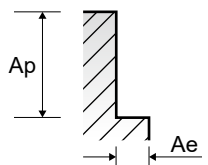



Leading Through Innovation



SOLID CARBIDE

**D-POWER CFRP
END MILLS**

D - POWER CFK VHM - Fräser

- For Composite Materials including CFRP and GFRP
- Für Verbundwerkstoffe einschließlich CFK und GFK

SELECTION GUIDE



SERIES	GU40	GU39
FLUTE	4, 6, 8	4
HELIX ANGLE	20° / 20° DUAL HELIX	15°
CUTTING EDGE SHAPE	SQUARE	SQUARE
SIZE MIN	D6.0	D6.0
SIZE MAX	D12.0	D12.0
PAGE	522	523

SOLID CARBIDE
D-POWER
for CFRP
END MILLS

For composite materials including CFRP, GFRP



Please visit
globalyg1.com/mat
for material search

◎ : Excellent ○ : Good

Recommended cutting conditions : P 524

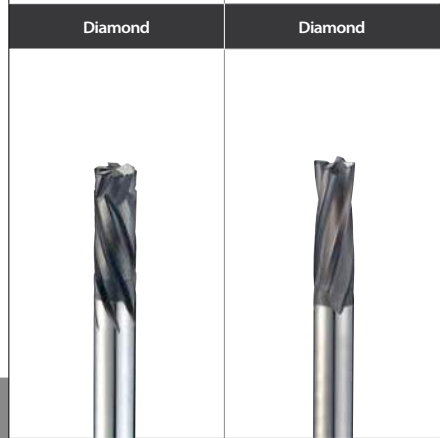

HSS

CBN
END MILLS

i-Xmill
END MILLS

i-SMART
MODULAR
END MILLS

X5070
END MILLS

4G MILL
END MILLS

X-POWER
PRO
END MILLS

TitaNox-
POWER
END MILLS

JET-POWER
END MILLS

V7 PLUS
END MILLS

ALU-POWER
HPC
END MILLS

ALU-
POWER
END MILLS

D-POWER
GRAPHITE
END MILLS

D-POWER
CFRP
END MILLS

ROUTERS

CRX S
END MILLS

K-2
END MILLS

ONLY ONE
COATED PM60
END MILLS

TANK-
POWER
END MILLS

GENERAL
HSS
END MILLS

MILLING
CUTTERS

TECHNICAL
DATA

ISO	VDI 3323	Material Description	Composition / Structure / Heat Treatment	HB	HRc
P	1	Non-alloy steel	About 0.15% C Annealed	125	
	2		About 0.45% C Annealed	190	13
	3		About 0.45% C Quenched & Tempered	250	25
	4		About 0.75% C Annealed	270	28
	5		About 0.75% C Quenched & Tempered	300	32
	6	Low alloy steel	Annealed	180	10
	7		Quenched & Tempered	275	29
	8		Quenched & Tempered	300	32
	9		Quenched & Tempered	350	38
	10		High alloyed steel, and tool steel	Annealed	200
	11	Quenched & Tempered		325	35
M	12	Stainless steel	Ferritic / Martensitic Annealed	200	15
	13		Martensitic Quenched & Tempered	240	23
	14		Austenitic	180	10
K	15	Grey cast iron	Pearlitic / ferritic	180	10
	16		Pearlitic (Martensitic)	260	26
	17	Nodular cast iron	Ferritic	160	3
	18		Pearlitic	250	25
	19	Malleable cast iron	Ferritic	130	
	20		Pearlitic	230	21
N	21	Aluminum-wrought alloy	Not Curable	60	
	22		Curable Hardened	100	
	23	Aluminum-cast, alloyed	≤ 12% Si, Not Curable	75	
	24		≤ 12% Si, Curable Hardened	90	
	25		> 12% Si, Not Curable	130	
	26	Copper and Copper Alloys (Bronze / Brass)	Cutting Alloys, PB>1%	110	
	27		CuZn, CuSnZn (Brass)	90	
	28		CuSn, lead-free copper and electrolytic copper	100	
	29.1	Non Metallic Materials	Duroplastic, Fiber Reinforced Plastic		
	29.2		Graphite		
29.3	CFRP, GFRP			◎	
30	Rubber, Wood, etc.				
S	31	Heat Resistant Super Alloys	Fe Based Annealed	200	15
	32		Cured	280	30
	33		Annealed	250	25
	34		Cured	350	38
	35	Ni or Co Based Cast	320	34	
	36	Titanium Alloys	Pure Titanium	400 Rm	
	37		Alpha + Beta Alloys Hardened	1050 Rm	
H	38	Hardened steel	Hardened	550	55
	39		Hardened	630	60
	40	Chilled Cast Iron	Cast	400	42
	41	Hardened Cast Iron	Hardened	550	55

CBN
END MILLS

i-Xmill
END MILLS

i-SMART
MODULAR
END MILLS

X5070
END MILLS

4G MILL
END MILLS

X-POWER
PRO
END MILLS

TitaNox-
POWER
END MILLS

JET-POWER
END MILLS

V7 PLUS
END MILLS

ALU-POWER
HPC
END MILLS

ALU-
POWER
END MILLS

D-POWER
GRAPHITE
END MILLS

**D-POWER
CFRP
END MILLS**

ROUTERS

CRX S
END MILLS

K-2
END MILLS

ONLY ONE
COATED PM60
END MILLS

TANK-
POWER
END MILLS

GENERAL
HSS
END MILLS

MILLING
CUTTERS

TECHNICAL
DATA

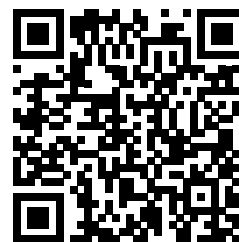

Scan QR Code
to See More Tools for
COMPOSITE MATERIALS

D-Power for CFRP is
only available till stock runs out!

CARBIDE, MULTI FLUTE DUAL HELIX

- **VOLLHARTMETALL, MULTI SCHNEIDEN DOPPEL HELIX**
- **Fraise carbure, multi-dents, double hélice**
- **MD, MULTI ELICA CONTRAPPOSTA**

- ▶ For composite materials - CFRP, GFRP.
- ▶ Reduce delamination and burrs.
- ▶ Diamond coating with excellent abrasion resistance

- ▶ Für verbund materialien - CFK und GFK
- ▶ Verringert Ablösungen (Delamination) und Gratbildung
- ▶ Diamant-Beschichtung mit ausgezeichneter Abriebfestigkeit.



CARBIDE 4-8 20°/20° PLAIN P.524

Unit : mm

EDP No.	Corner Radius	Mill Diameter	Shank Diameter	Length of Cut	Overall Length	No. of Flute
	R	D1	D2	L1(l)	L2	
▲ GUF40060	R0.5	6.0	6	12(3)	65	4
▲ GUF40080	R0.5	8.0	8	16(4)	70	6
▲ GUF40100	R0.5	10.0	10	20(5)	80	6
▲ GUF40120	R0.5	12.0	12	24(6)	90	8

▲ : Only available till stock runs out

Mill Dia. Tolerance (mm)	Shank Dia. Tolerance
0 ~ - 0.03	h5



Scan QR Code to See More Tools for COMPOSITE MATERIALS
D-Power for CFRP is only available till stock runs out!

◎ : Excellent ○ : Good

ISO Material Description	P									M				K							
	Non-alloy steel					Low alloy steel				High alloyed steel, and tool steel		Stainless steel		Grey cast iron		Nodular cast iron		Malleable cast iron			
VDI 3323	1	2	3	4	5	6	7	8	9	10	11	12	13	14	15	16	17	18	19	20	
HRc		13	25	28	32	10	29	32	38	15	35	15	23	10	10	26	3	25		21	
HB	125	190	250	270	300	180	275	300	350	200	325	200	240	180	180	260	160	250	130	230	
Recommend																					
ISO Material Description	N										S						H				
	Aluminum-wrought alloy		Aluminum-cast, alloyed			Copper and Copper Alloys (Bronze / Brass)			Non Metallic Materials		Heat Resistant Super Alloys						Titanium Alloys		Hardened steel	Chilled Cast Iron	Hardened Cast Iron
VDI 3323	21	22	23	24	25	26	27	28	29	30	31	32	33	34	35	36	37	38	39	40	41
HRc											15	30	25	38	34			55	60	42	55
HB	60	100	75	90	130	110	90	100			200	280	250	350	320	400 Rm	1050 Rm	550	630	400	550
Recommend																					



D-POWER CFRP END MILLS

PLAIN SHANK

GUF39 SERIES

CARBIDE, 4 FLUTE

- VOLLHARTMETALL, 4 SCHNEIDEN
- Fraise carbure, 4 dents
- MD, 4 TAGLIANTI

- ▶ For composite materials - CFRP, GFRP.
- ▶ Reduce delamination and burrs.
- ▶ Diamond coating with excellent abrasion resistance

- ▶ Für verbundmaterialien - CFK und GFK
- ▶ Verringert Ablösungen (Delamination) und Gratbildung
- ▶ Diamant-Beschichtung mit ausgezeichneter Abriebfestigkeit.



EDP No.	Corner Radius	Mill Diameter	Shank Diameter	Length of Cut	Overall Length
	R	D1	D2	L1	L2
▲ GUF39060	R0.2	6.0	6	18	65
▲ GUF39080	R0.2	8.0	8	24	70
▲ GUF39100	R0.3	10.0	10	30	80
▲ GUF39120	R0.3	12.0	12	36	100

▲ : Only available till stock runs out

Mill Dia. Tolerance (mm)	Shank Dia. Tolerance
0 ~ - 0.03	h5



Scan QR Code to See More Tools for COMPOSITE MATERIALS
D-Power for CFRP is only available till stock runs out!

ISO	P										M				K								
	Non-alloy steel					Low alloy steel					High alloyed steel, and tool steel				Stainless steel				Grey cast iron		Nodular cast iron		Malleable cast iron
VDI 3323	1	2	3	4	5	6	7	8	9	10	11	12	13	14	15	16	17	18	19	20			
HRc	13	25	28	32	10	29	32	38	15	35	15	23	10	10	26	3	25	42	21				
HB	125	190	250	270	300	180	275	300	350	200	325	200	240	180	180	260	160	250	130	230			
Recommend																							
ISO	N					S					H												
	Aluminum-wrought alloy		Aluminum-cast, alloyed			Copper and Copper Alloys (Bronze / Brass)			Non Metallic Materials		Heat Resistant Super Alloys					Titanium Alloys		Hardened steel	Chilled Cast Iron	Hardened Cast Iron			
VDI 3323	21	22	23	24	25	26	27	28	29	30	31	32	33	34	35	36	37	38	39	40	41		
HRc	60	100	75	90	130	110	90	100			15	30	25	38	34	55	60	55	60	42	55		
HB	60	100	75	90	130	110	90	100			200	280	250	350	320	400 Rm	1050 Rm	550	630	400	550		
Recommend																							

◎ : Excellent ○ : Good

GUF40 SERIES

MULTI FLUTE DUAL HELIX - SIDE CUTTING

Vc = m/min.
fz = mm/tooth
RPM = rev./min.
FEED = mm/min.

ISO	VDI 3323	Material Description	Ae	Ap	Parameter	Diameter (Ø)			
						6.0	8.0	10.0	12.0
N	29.3	CFRP	0.4D	1.0D	Vc	150	150	150	150
					fz	0.035	0.045	0.055	0.065
					RPM	7958	5968	4775	3979
			FEED	1114	1611	1576	2069		
			0.02D	1.0D	Vc	200	200	200	200
					fz	0.047	0.062	0.077	0.092
		RPM			10610	7958	6366	5305	
		GFRP	0.4D	1.0D	Vc	80	80	80	80
					fz	0.025	0.031	0.037	0.043
					RPM	4244	3183	2546	2122
			FEED	424	592	565	730		
			0.02D	1.0D	Vc	100	100	100	100
fz	0.035				0.040	0.045	0.050		
RPM	5305	3979			3183	2653			
FEED	743	955	859	1061					

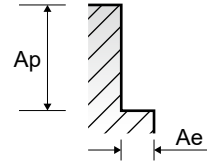

GUF39 SERIES

4 FLUTE - SIDE CUTTING

ISO	VDI 3323	Material Description	Ae	Ap	Parameter	Diameter (Ø)			
						6.0	8.0	10.0	12.0
N	29.3	CFRP	0.4D	1.5D	Vc	200	200	200	200
					fz	0.035	0.045	0.055	0.065
					RPM	10610	7958	6366	5305
			FEED	1485	1432	1401	1379		
			0.1D	1.5D	Vc	200	200	200	200
					fz	0.028	0.036	0.044	0.052
		RPM			10610	7958	6366	5305	
		FEED	1188	1146	1120	1103			
		GFRP	0.4D	1.5D	Vc	100	100	100	100
					fz	0.025	0.031	0.037	0.043
					RPM	5305	3979	3183	2653
			FEED	531	493	471	456		
0.1D	1.5D		Vc	100	100	100	100		
			fz	0.025	0.028	0.032	0.035		
		RPM	5305	3979	3183	2653			
FEED	531	446	407	371					

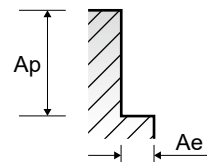



Leading Through Innovation



SOLID CARBIDE

ROUTERS

Mikroverzahnter VHM Fräser

- For Composite Materials including CFRP and GFRP
- Für Verbundwerkstoffe einschließlich CFK und GFK

SELECTION GUIDE

HSS



SERIES	RTI104
FLUTE	-
HELIX ANGLE	-
CUTTING EDGE SHAPE	ROUTER
SIZE MIN	D3.0
SIZE MAX	D12.0
PAGE	527

CBN END MILLS

i-Xmill END MILLS

i-SMART MODULAR END MILLS

X5070 END MILLS

4G MILL END MILLS

X-POWER PRO END MILLS

TitaNox-POWER END MILLS

JET-POWER END MILLS

V7 PLUS END MILLS

ALU-POWER HPC END MILLS

ALU-POWER END MILLS

D-POWER GRAPHITE END MILLS

D-POWER CFRP END MILLS

ROUTERS

CRX S END MILLS

K-2 END MILLS

ONLY ONE COATED PM60 END MILLS

TANK-POWER END MILLS

GENERAL HSS END MILLS

MILLING CUTTERS

TECHNICAL DATA

SOLID CARBIDE ROUTERS

For composite materials including CFRP, GFRP

Diamond



Please visit globalyg1.com/mat for material search

◎ : Excellent ○ : Good

Recommended cutting conditions : P 528

ISO	VDI 3323	Material Description	Composition / Structure / Heat Treatment	HB	HRc	
P	1	Non-alloy steel	About 0.15% C Annealed	125		
	2		About 0.45% C Annealed	190	13	
	3		About 0.45% C Quenched & Tempered	250	25	
	4		About 0.75% C Annealed	270	28	
	5		About 0.75% C Quenched & Tempered	300	32	
	6	Low alloy steel	Annealed	180	10	
	7		Quenched & Tempered	275	29	
	8		Quenched & Tempered	300	32	
	9		Quenched & Tempered	350	38	
	10		High alloyed steel, and tool steel	Annealed	200	15
	11	Quenched & Tempered		325	35	
M	12	Stainless steel	Ferritic / Martensitic Annealed	200	15	
	13		Martensitic Quenched & Tempered	240	23	
	14		Austenitic	180	10	
K	15	Grey cast iron	Pearlitic / ferritic	180	10	
	16		Pearlitic (Martensitic)	260	26	
	17	Nodular cast iron	Ferritic	160	3	
	18		Pearlitic	250	25	
	19		Ferritic	130		
20	Malleable cast iron	Pearlitic	230	21		
N	21	Aluminum-wrought alloy	Not Curable	60		
	22		Curable Hardened	100		
	23	Aluminum-cast, alloyed	≤ 12% Si, Not Curable	75		
	24		≤ 12% Si, Curable Hardened	90		
	25		> 12% Si, Not Curable	130		
	26	Copper and Copper Alloys (Bronze / Brass)	Cutting Alloys, PB>1%	110		
	27		CuZn, CuSnZn (Brass)	90		
	28		CuSn, lead-free copper and electrolytic copper	100		
	29.1	Non Metallic Materials	Duroplastic, Fiber Reinforced Plastic			
	29.2		Graphite			
29.3	CFRP, GFRP				◎	
30	Rubber, Wood, etc.					
S	31	Heat Resistant Super Alloys	Fe Based Annealed	200	15	
	32		Cured	280	30	
	33		Annealed	250	25	
	34		Ni or Co Based Cured	350	38	
	35		Cast	320	34	
	36	Titanium Alloys	Pure Titanium	400 Rm		
	37		Alpha + Beta Alloys Hardened	1050 Rm		
H	38	Hardened steel	Hardened	550	55	
	39		Hardened	630	60	
	40	Chilled Cast Iron	Cast	400	42	
	41	Hardened Cast Iron	Hardened	550	55	



CARBIDE, ROUTER END MILL TYPE

● MIKROVERZAHNTER VHM FRÄSER

○ FRAISE CARBURE À DÉTOURER

○ ROUTERS DI SGROS. - CFRP & GFRP (Per lavorazioni di materiali compositi)

- ▶ For composite materials - CFRP, GFRP.
- ▶ Reduce delamination and burrs.
- ▶ Diamond coating with excellent abrasion resistance

- ▶ Für verbund materialien - CFK und GFK
- ▶ Verringert Ablösungen (Delamination) und Gratbildung
- ▶ Diamant-Beschichtung mit ausgezeichneter Abriebfestigkeit.

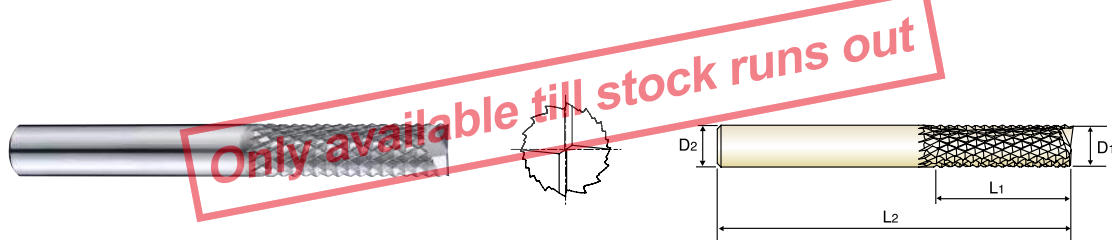

EDP No.	Mill Diameter	Shank Diameter	Length of Cut	Overall Length
	D1	D2	L1	L2
▲ RTI104030	3.0	3	9	50
▲ RTI104040	4.0	4	12	50
▲ RTI104050	5.0	5	15	50
▲ RTI104060	6.0	6	18	65
▲ RTI104080	8.0	8	24	75
▲ RTI104100	10.0	10	30	85
▲ RTI104120	12.0	12	36	100

▲ : Only available till stock runs out

Mill Dia. Tolerance (mm)	Shank Dia. Tolerance
- 0.02 ~ - 0.08	h5

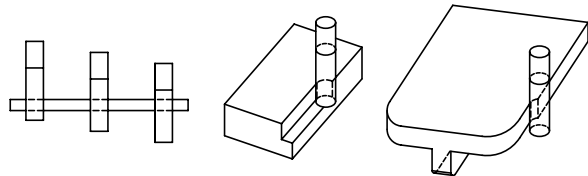

Scan QR Code to See More Tools for COMPOSITE MATERIALS
 SOLID CARBIDE ROUTERS is only available till stock runs out!

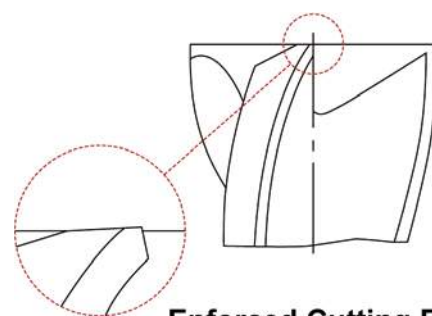

Enforced Cutting Edge

◎ : Excellent ○ : Good

ISO Material Description	P										M				K						
	Non-alloy steel					Low alloy steel					High alloyed steel, and tool steel				Stainless steel		Grey cast iron		Nodular cast iron		Malleable cast iron
VDI 3323	1	2	3	4	5	6	7	8	9	10	11	12	13	14	15	16	17	18	19	20	
HRC																					
HB	125	190	250	270	300	180	275	300	350	200	325	200	240	180	180	260	160	250	130	230	
Recommend																					
ISO Material Description	N					S					H										
	Aluminum-wrought alloy		Aluminum-cast, alloyed			Copper and Copper Alloys (Bronze / Brass)			Non Metallic Materials		Heat Resistant Super Alloys					Titanium Alloys		Hardened steel	Chilled Cast Iron	Hardened Cast Iron	
VDI 3323	21	22	23	24	25	26	27	28	29	30	31	32	33	34	35	36	37	38	39	40	41
HRC																					
HB	60	100	75	90	130	110	90	100			200	280	250	350	320	400 Rm	1050 Rm	550	630	400	550
Recommend																					



RT1104 SERIES

ROUTER END MILL TYPE - SIDE CUTTING

Vc = m/min.
fz = mm/tooth
RPM = rev./min.
FEED = mm/min.

ISO	VDI 3323	Material Description	Ae	Ap	Parameter	Diameter (Ø)						
						3.0	4.0	5.0	6.0	8.0	10.0	12.0
N	29.3	CFRP	0.35D	2.0D	Vc	200	200	200	200	200	200	200
					fz	-	-	-	-	-	-	-
					RPM	21221	15915	12732	10610	7958	6366	5305
		GFRP	0.35D	2.0D	FEED	1270	1430	1910	2225	2623	3053	3393
					Vc	100	100	100	100	100	100	100
					fz	-	-	-	-	-	-	-
X5070					RPM	10610	7958	6366	5305	3979	3183	2653
					FEED	635	715	955	1113	1311	1526	1697

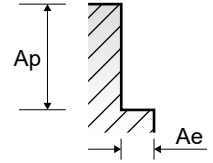

CBN END MILLS

i-Xmill END MILLS

i-SMART MODULAR END MILLS

X5070 END MILLS

4G MILL END MILLS

X-POWER PRO END MILLS

TitaNox-POWER END MILLS

JET-POWER END MILLS

V7 PLUS END MILLS

ALU-POWER HPC END MILLS

ALU-POWER END MILLS

D-POWER GRAPHITE END MILLS

D-POWER CFRP END MILLS

ROUTERS

CRX S END MILLS

K-2 END MILLS

ONLY ONE COATED PMØ0 END MILLS

TANK-POWER END MILLS

GENERAL HSS END MILLS

MILLING CUTTERS

TECHNICAL DATA



Leading Through Innovation



SOLID CARBIDE

CRX S END MILLS

CRX S FRÄSER

- DLC Coated Carbide End Mills for Copper
- DLC beschichtete VHM Fräser für die Kuper - und Kupferlegierungen zu bearbeiten

SELECTION GUIDE



SERIES	SGED28	SGED27	SGED29	SGED31	SGED30
FLUTE	2	2	2	2	2
HELIX ANGLE	30°	30°	30°	30°	30°
CUTTING EDGE SHAPE	BALL NOSE	BALL NOSE	CORNER RADIUS	SQUARE	SQUARE
SIZE MIN	R0.5	R0.25	D1.0	D1.0	D0.5
SIZE MAX	R6.0	R6.0	D12.0	D12.0	D12.0
PAGE	531	532	534	536	537

SOLID CARBIDE
CRX S
END MILLS

DLC Coated Carbide End Mills for Copper



Please visit globalyg1.com/mat for material search

◎ : Excellent ○ : Good

Recommended cutting conditions : P 539

ISO	VDI 3323	Material Description	Composition / Structure / Heat Treatment	HB	HRc					
P	1	Non-alloy steel	About 0.15% C Annealed	125						
	2		About 0.45% C Annealed	190	13					
	3		About 0.45% C Quenched & Tempered	250	25					
	4		About 0.75% C Annealed	270	28					
	5		About 0.75% C Quenched & Tempered	300	32					
	6	Low alloy steel	Annealed	180	10					
	7		Quenched & Tempered	275	29					
	8		Quenched & Tempered	300	32					
	9		Quenched & Tempered	350	38					
	10		High alloyed steel, and tool steel	Annealed	200	15				
	11	Quenched & Tempered		325	35					
M	12	Stainless steel	Ferritic / Martensitic Annealed	200	15					
	13		Martensitic Quenched & Tempered	240	23					
	14		Austenitic	180	10					
K	15	Grey cast iron	Pearlitic / ferritic	180	10					
	16		Pearlitic (Martensitic)	260	26					
	17	Nodular cast iron	Ferritic	160	3					
	18		Pearlitic	250	25					
	19		Ferritic	130						
20	Malleable cast iron	Pearlitic	230	21						
N	21	Aluminum-wrought alloy	Not Curable	60		○	○	○	○	○
	22		Curable Hardened	100		○	○	○	○	○
	23	Aluminum-cast, alloyed	≤ 12% Si, Not Curable	75						
	24		≤ 12% Si, Curable Hardened	90						
	25		> 12% Si, Not Curable	130						
	26		Copper and Copper Alloys (Bronze / Brass)	Cutting Alloys, PB>1%	110		◎	◎	◎	◎
	27	Copper and Copper Alloys (Bronze / Brass)	CuZn, CuSnZn (Brass)	90		◎	◎	◎	◎	◎
	28		CuSn, lead-free copper and electrolytic copper	100		◎	◎	◎	◎	◎
	29		Non Metallic Materials	Duroplastic, Fiber Reinforced Plastic			○	○	○	○
	30	Rubber, Wood, etc.								
S	31	Heat Resistant Super Alloys	Fe Based Annealed	200	15					
	32		Cured	280	30					
	33		Annealed	250	25					
	34		Cured	350	38					
	35	Ni or Co Based Cast	320	34						
	36	Titanium Alloys	Pure Titanium	400 Rm						
	37		Alpha + Beta Alloys Hardened	1050 Rm						
H	38	Hardened steel	Hardened	550	55					
	39		Hardened	630	60					
	40	Chilled Cast Iron	Cast	400	42					
	41	Hardened Cast Iron	Hardened	550	55					

CARBIDE, 2 FLUTE BALL NOSE DLC COATING

- **VOLLHARTMETALL, 2 SCHNEIDEN STIRNRADIUS DLC BESCHICHTUNG**
- **Fraise carbure, 2 dents, hémisphérique, revêtue DLC**
- **2 TAGLIANTI, SEMISFERICA, RIVESTIMENTO DLC**

- ▶ Designed for copper, copper alloys, soft graphite, reinforced plastics and materials affiliated with non-ferrous metals.
- ▶ Tight radius tolerance is applied ($\pm 0.005\text{mm}$ tolerance under R3).
- ▶ Excellent surface roughness from Mirror Face of cutting edges

- ▶ Entwickelt für die Bearbeitung von Kupfer, Kupferlegierungen, sowie faserverstärkten Kunststoffen, NE- Metallen
- ▶ Hochgenaue Raduistoleranz ($\pm 0.005\text{mm}$ Toleranz unter R3mm)
- ▶ Sehr gute Oberflächenrauigkeit wird durch die besonders behandelte Schneide erreicht



Unit : mm

EDP No.	Radius of Ball Nose R(± 0.005)	Mill Diameter	Shank Diameter	Length of Cut	Overall Length
SGED28010	R0.5	1.0	6	2.5	50
SGED28015	R0.75	1.5	6	4	50
SGED28020	R1.0	2.0	6	5	50
SGED28030	R1.5	3.0	6	8	60
SGED28040	R2.0	4.0	6	8	70
SGED28050	R2.5	5.0	6	12	90
SGED28060	R3.0	6.0	6	12	90
SGED28080	R4.0	8.0	8	16	100
SGED28100	R5.0	10.0	10	20	100
SGED28120	R6.0	12.0	12	25	110

Size	Radius Tolerance (mm)	Mill Dia. Tolerance (mm)	Shank Dia. Tolerance
up to R3	± 0.005	0 ~ - 0.012	h5
over R3		0 ~ - 0.015	

◎ : Excellent ○ : Good

ISO Material Description	P										M				K						
	Non-alloy steel					Low alloy steel					High alloyed steel, and tool steel				Stainless steel		Grey cast iron		Nodular cast iron		Malleable cast iron
VDI 3323	1	2	3	4	5	6	7	8	9	10	11	12	13	14	15	16	17	18	19	20	
HRC	13	25	28	32	10	29	32	38	15	35	15	23	10	10	26	3	25	25	21		
HB	125	190	250	270	300	180	275	300	350	200	325	200	240	180	180	260	160	250	130	230	
Recommend																					

ISO Material Description	N					S					H										
	Aluminum-wrought alloy		Aluminum-cast, alloyed			Copper and Copper Alloys (Bronze / Brass)		Non Metallic Materials			Heat Resistant Super Alloys					Titanium Alloys		Hardened steel	Chilled Cast Iron	Hardened Cast Iron	
VDI 3323	21	22	23	24	25	26	27	28	29	30	31	32	33	34	35	36	37	38	39	40	41
HRC	60	100	75	90	130	110	90	100			15	30	25	38	34	55	60	55	60	42	55
HB	60	100	75	90	130	110	90	100			200	280	250	350	320	400 Rm	1050 Rm	550	630	400	550
Recommend	○	○				◎	◎	◎		○											

CARBIDE, 2 FLUTE BALL NOSE DLC COATING with EXTENDED NECK

● **VOLLHARTMETALL, 2 SCHNEIDEN STIRNRADIUS DLC BESCHICHTUNG mit ABGESETZTEM SCHAFTTETTEL**
 (●) **Fraise carbure, 2 dents, hémisphérique, détalonnée, revêtue DLC**
 (●) **2 TAGLIENTI, SEMISFERICA CON SCARICO ESTESO, RIV. DLC**

- ▶ Designed for copper, copper alloys soft graphite, reinforced plastics and the materials affiliated with non-ferrous metals.
- ▶ Tight radius tolerance is applied ($\pm 0.005\text{mm}$ tolerance under R3).
- ▶ Excellent surface roughness thanks to Mirror Face of cutting edges
- ▶ High strength and minimized vibration are available due to two step taper neck(under R0.5).

- ▶ Entwickelt für die Bearbeitung von Kupfer, Kupferlegierungen, sowie faserverstärkten Kunststoffen, NE- Metallen
- ▶ Hochgenaue Raduistoleranz ($\pm 0.005\text{mm}$ Toleranz unter R3mm)
- ▶ Sehr gute Oberflächenrauigkeit wird durch die besonders behandelte Schneide erreicht
- ▶ Hohe Zähigkeit und verminderte Vibrationen werden durch den besonderen kegelförmigen Hals erreicht, (unter R 0,5mm)

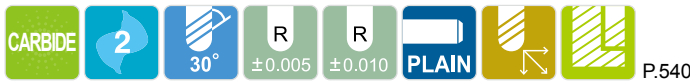
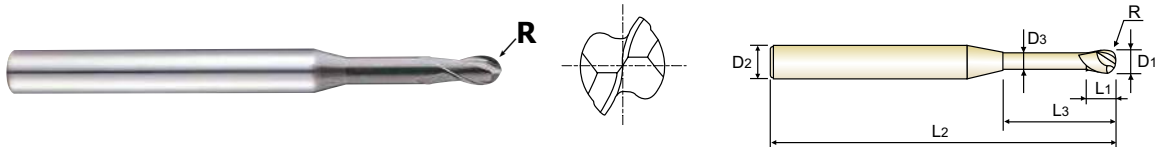

R0.25-R3 R4-R6

Unit : mm

EDP No.	Radius of Ball Nose	Mill Diameter	Shank Diameter	Length of Cut	Length Below Shank	Overall Length	Neck Diameter
	R(± 0.005)						
SGED2700502	R0.25	0.5	4	0.5	2	45	0.45
SGED2700504	R0.25	0.5	4	0.5	4	45	0.45
SGED2700506	R0.25	0.5	4	0.5	6	45	0.45
SGED2700508	R0.25	0.5	4	0.5	8	45	0.45
SGED2700510	R0.25	0.5	4	0.5	10	45	0.45
SGED2700602	R0.3	0.6	4	0.6	2	45	0.55
SGED2700604	R0.3	0.6	4	0.6	4	45	0.55
SGED2700606	R0.3	0.6	4	0.6	6	45	0.55
SGED2700608	R0.3	0.6	4	0.6	8	45	0.55
SGED2700610	R0.3	0.6	4	0.6	10	45	0.55
SGED2700804	R0.4	0.8	4	0.8	4	45	0.75
SGED2700806	R0.4	0.8	4	0.8	6	45	0.75
SGED2700808	R0.4	0.8	4	0.8	8	45	0.75
SGED2700810	R0.4	0.8	4	0.8	10	45	0.75
SGED2700812	R0.4	0.8	4	0.8	12	45	0.75
SGED2701004	R0.5	1.0	4	1	4	45	0.95
SGED2701006	R0.5	1.0	4	1	6	45	0.95
SGED2701008	R0.5	1.0	4	1	8	45	0.95
SGED2701010	R0.5	1.0	4	1	10	45	0.95
SGED2701012	R0.5	1.0	4	1	12	45	0.95
SGED2701506	R0.75	1.5	4	1.5	6	45	1.45
SGED2701508	R0.75	1.5	4	1.5	8	45	1.45
SGED2701510	R0.75	1.5	4	1.5	10	45	1.45
SGED2701512	R0.75	1.5	4	1.5	12	45	1.45

▶ NEXT PAGE

Size	Radius Tolerance (mm)	Mill Dia. Tolerance (mm)	Shank Dia. Tolerance
up to R3	± 0.005	0 ~ -0.012	h5
over R3	± 0.010	0 ~ -0.015	

◎ : Excellent ○ : Good

ISO Material Description	P											M				K								
	Non-alloy steel					Low alloy steel						High alloyed steel, and tool steel				Stainless steel				Grey cast iron		Nodular cast iron		Malleable cast iron
VDI 3323	1	2	3	4	5	6	7	8	9	10	11	12	13	14	15	16	17	18	19	20				
HRc	13	25	28	32	10	29	32	38	15	35	15	23	10	10	26	3	25	42	21					
HB	125	190	250	270	300	180	275	300	350	200	325	200	240	180	180	260	160	250	130	230				
Recommend																								
ISO Material Description	N										S							H						
	Aluminum-wrought alloy		Aluminum-cast, alloyed			Copper and Copper Alloys (Bronze / Brass)			Non Metallic Materials		Heat Resistant Super Alloys					Titanium Alloys		Hardened steel	Chilled Cast Iron	Hardened Cast Iron				
VDI 3323	21	22	23	24	25	26	27	28	29	30	31	32	33	34	35	36	37	38	39	40	41			
HRc											15	30	25	38	34			55	60	42	55			
HB	60	100	75	90	130	110	90	100			200	280	250	350	320	400 Rm	1050 Rm	550	630	400	550			
Recommend	○	○				◎	◎	◎		○														

CARBIDE, 2 FLUTE BALL NOSE DLC COATING with EXTENDED NECK

- VOLLHARTMETALL, 2 SCHNEIDEN STIRNRADIUS DLC BESCHICHTUNG mit ABGESETZTEM SCHAFTTETL
- Fraise carbure, 2 dents, hémisphérique, détalonnée, revêtue DLC
- 2 TAGLIANTI, SEMISFERICA CON SCARICO ESTESO, RIV. DLC

- ▶ Designed to copper, copper alloys soft graphite, reinforced plastics and the materials affiliated with non-ferrous metals.
- ▶ Tight radius tolerance is applied ($\pm 0.005\text{mm}$ tolerance under R3).
- ▶ Excellent surface roughness thanks to Mirror Face of cutting edges
- ▶ High strength and minimized vibration are available due to two step taper neck(under R0.5).

- ▶ Entwickelt für die Bearbeitung von Kupfer, Kupferlegierungen, sowie faserverstärkten Kunststoffen, NE- Metallen
- ▶ Hochgenaue Raduistoleranz ($\pm 0.005\text{mm}$ Toleranz unter R3mm)
- ▶ Sehr gute Oberflächenrauigkeit wird durch die besonders behandelte Schneide erreicht
- ▶ Hohe Zähigkeit und verminderte Vibrationen werden durch den besonderen kegelförmigen Hals erreicht, (unter R 0,5mm)

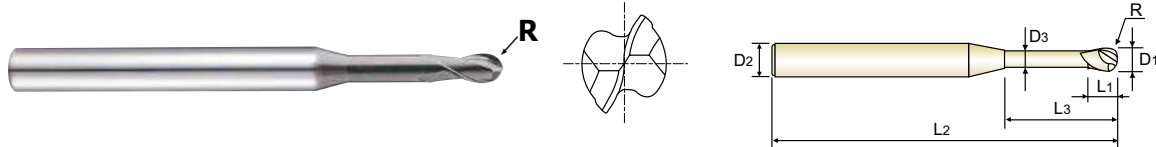

CARBIDE 2 30° R ±0.005 R ±0.010 PLAIN P.540

R0.25-R3 R4-R6

Unit : mm

EDP No.	Radius of Ball Nose	Mill Diameter	Shank Diameter	Length of Cut	Length Below Shank	Overall Length	Neck Diameter
	R(± 0.005)	D1	D2	L1	L3	L2	D3
SGED2701516	R0.75	1.5	4	1.5	16	50	1.45
SGED2702006	R1.0	2.0	4	3	6	45	1.95
SGED2702008	R1.0	2.0	4	3	8	45	1.95
SGED2702010	R1.0	2.0	4	3	10	45	1.95
SGED2702012	R1.0	2.0	4	3	12	45	1.95
SGED2702016	R1.0	2.0	4	3	16	50	1.95
SGED2703010	R1.5	3.0	6	4	10	50	2.85
SGED2703012	R1.5	3.0	6	4	12	50	2.85
SGED2703016	R1.5	3.0	6	4	16	60	2.85
SGED2703020	R1.5	3.0	6	4	20	60	2.85
SGED2704010	R2.0	4.0	6	5	10	50	3.85
SGED2704012	R2.0	4.0	6	5	12	50	3.85
SGED2704016	R2.0	4.0	6	5	16	60	3.85
SGED2704020	R2.0	4.0	6	5	20	60	3.85
SGED2704025	R2.0	4.0	6	5	25	60	3.85
SGED2706020	R3.0	6.0	6	8	20	60	5.85
SGED2706030	R3.0	6.0	6	8	30	90	5.85
SGED2708020	R4.0	8.0	8	10	20	70	7.70
SGED2710025	R5.0	10.0	10	12	25	80	9.70
SGED2712025	R6.0	12.0	12	14	25	80	11.70

Size	Radius Tolerance (mm)	Mill Dia. Tolerance (mm)	Shank Dia. Tolerance
up to R3	± 0.005	0 ~ - 0.012	h5
over R3	± 0.010	0 ~ - 0.015	

◎ : Excellent ○ : Good

ISO Material Description	P										M				K								
	Non-alloy steel					Low alloy steel					High alloyed steel, and tool steel				Stainless steel				Grey cast iron		Nodular cast iron		Malleable cast iron
VDI 3323	1	2	3	4	5	6	7	8	9	10	11	12	13	14	15	16	17	18	19	20			
HRc		13	25	28	32	10	29	32	38	15	35	15	23	10	10	26	3	25	25	21			
HB	125	190	250	270	300	180	275	300	350	200	325	200	240	180	180	260	160	250	130	230			
Recommend																							

ISO Material Description	N					S					H										
	Aluminum-wrought alloy		Aluminum-cast, alloyed		Copper and Copper Alloys (Bronze / Brass)	Non Metallic Materials	Heat Resistant Super Alloys				Titanium Alloys		Hardened steel	Chilled Cast Iron	Hardened Cast Iron						
VDI 3323	21	22	23	24	25	26	27	28	29	30	31	32	33	34	35	36	37	38	39	40	41
HRc											15	30	25	38	34			55	60	42	55
HB	60	100	75	90	130	110	90	100			200	280	250	350	320	400 Rm	1050 Rm	550	630	400	550
Recommend	○	○				◎	◎	◎		○											

CARBIDE, 2 FLUTE CORNER RADIUS DLC COATING with EXTENDED NECK

- **VOLLHARTMETALL, 2 SCHNEIDEN ECKENRADIUS DLC Beschichtung mit ABGESETZTEM SCHAFTTETEL**
- **Fraise carbure, 2 dents, torique, détalonnée, revêtue DLC**
- **2 TAGLIANTI, TORICA CON SCARICO ESTESO, RIVESTIMENTO DLC**

- ▶ Designed for copper, copper alloys, soft graphite, reinforced plastics and materials affiliated with non-ferrous metals.
- ▶ Excellent surface roughness from Mirror Face of cutting edges

- ▶ Entwickelt für die Bearbeitung von Kupfer, Kupferlegierungen, sowie faserverstärkten Kunststoffen, NE- Metallen
- ▶ Ausgelegt für verschiedene Anwendungen, z.B. schrumpfen, schrumpfschichten und zur schlicht Bearbeitung, aufgrund der neuartigen Geometrie

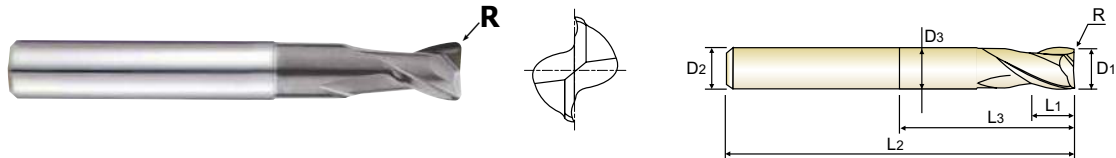

CARBIDE 2 30° ±0.010 ±0.015 PLAIN P.539

Ø1~Ø6 Ø8~Ø12

Unit : mm

EDP No.	Corner Radius	Mill Diameter	Shank Diameter	Length of Cut	Length Below Shank	Overall Length	Neck Diameter
	R	D1	D2	L1	L3	L2	D3
SGED290100104	R0.1	1.0	4	1.5	4	45	0.95
SGED290100106	R0.1	1.0	4	1.5	6	45	0.95
SGED290100108	R0.1	1.0	4	1.5	8	45	0.95
SGED290100204	R0.2	1.0	4	1.5	4	45	0.95
SGED290100206	R0.2	1.0	4	1.5	6	45	0.95
SGED290100208	R0.2	1.0	4	1.5	8	45	0.95
SGED290150106	R0.1	1.5	4	2.3	6	45	1.45
SGED290150108	R0.1	1.5	4	2.3	8	45	1.45
SGED290150110	R0.1	1.5	4	2.3	10	45	1.45
SGED290150206	R0.2	1.5	4	2.3	6	45	1.45
SGED290150208	R0.2	1.5	4	2.3	8	45	1.45
SGED290150210	R0.2	1.5	4	2.3	10	45	1.45
SGED290200208	R0.2	2.0	4	3	8	45	1.95
SGED290200210	R0.2	2.0	4	3	10	45	1.95
SGED290200212	R0.2	2.0	4	3	12	45	1.95
SGED290200508	R0.5	2.0	4	3	8	45	1.95
SGED290200510	R0.5	2.0	4	3	10	45	1.95
SGED290200512	R0.5	2.0	4	3	12	45	1.95
SGED290300210	R0.2	3.0	6	4.5	10	50	2.85
SGED290300212	R0.2	3.0	6	4.5	12	50	2.85
SGED290300216	R0.2	3.0	6	4.5	16	60	2.85
SGED290300310	R0.3	3.0	6	4.5	10	50	2.85
SGED290300312	R0.3	3.0	6	4.5	12	50	2.85
SGED290300316	R0.3	3.0	6	4.5	16	60	2.85

Size	Corner Radius Tolerance (mm)	Mill Dia. Tolerance (mm)	Shank Dia. Tolerance
up to Ø6	±0.010	0 ~ -0.012	h5
over Ø6	±0.015	0 ~ -0.015	

▶ NEXT PAGE

◎ : Excellent ○ : Good

ISO Material Description	P											M				K					
	Non-alloy steel					Low alloy steel				High alloyed steel, and tool steel		Stainless steel				Grey cast iron		Nodular cast iron		Malleable cast iron	
VDI 3323	1	2	3	4	5	6	7	8	9	10	11	12	13	14	15	16	17	18	19	20	
HRc		13	25	28	32	10	29	32	38	15	35	15	23	10	10	26	3	25		21	
HB	125	190	250	270	300	180	275	300	350	200	325	200	240	180	180	260	160	250	130	230	
Recommend																					
ISO Material Description	N										S							H			
	Aluminum-wrought alloy		Aluminum-cast, alloyed			Copper and Copper Alloys (Bronze / Brass)			Non Metallic Materials		Heat Resistant Super Alloys					Titanium Alloys		Hardened steel	Chilled Cast Iron	Hardened Cast Iron	
VDI 3323	21	22	23	24	25	26	27	28	29	30	31	32	33	34	35	36	37	38	39	40	41
HRc											15	30	25	38	34			55	60	42	55
HB	60	100	75	90	130	110	90	100			200	280	250	350	320	400 Rm	1050 Rm	550	630	400	550
Recommend	○	○				◎	◎	◎		○											

CARBIDE, 2 FLUTE CORNER RADIUS DLC COATING with EXTENDED NECK

- VOLLHARTMETALL, 2 SCHNEIDEN ECKENRADIUS DLC Beschichtung mit ABGESETZTEM SCHAFTTETEL
- Fraise carbure, 2 dents, torique, détalonnée, revêtue DLC
- 2 TAGLIENTI, TORICA CON SCARICO ESTESO, RIVESTIMENTO DLC

- ▶ Designed for copper, copper alloys, soft graphite, reinforced plastics and materials affiliated with non-ferrous metals.
- ▶ Excellent surface roughness from Mirror Face of cutting edges
- ▶ Entwickelt für die Bearbeitung von Kupfer, Kupferlegierungen, sowie faserverstärkten Kunststoffen, NE- Metallen
- ▶ Ausgelegt für verschiedene Anwendungen, z.B. schrumpfen, schrumpfschichten und zur schlicht Bearbeitung, aufgrund der neuartigen Geometrie

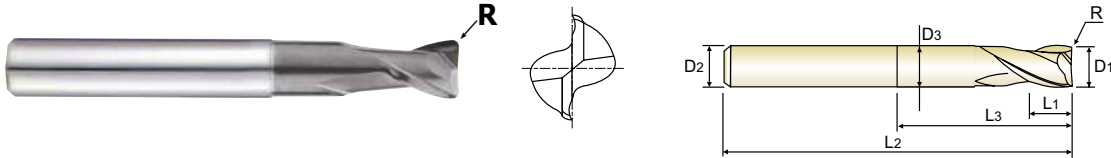

Ø1-Ø6 Ø8-Ø12

Unit : mm

EDP No.	Corner Radius	Mill Diameter	Shank Diameter	Length of Cut	Length Below Shank	Overall Length	Neck Diameter
	R	D1	D2	L1	L3	L2	D3
SGED290400212	R0.2	4.0	6	6	12	50	3.85
SGED290400216	R0.2	4.0	6	6	16	60	3.85
SGED290400220	R0.2	4.0	6	6	20	60	3.85
SGED290400512	R0.5	4.0	6	6	12	50	3.85
SGED290400516	R0.5	4.0	6	6	16	60	3.85
SGED290400520	R0.5	4.0	6	6	20	60	3.85
SGED290600320	R0.3	6.0	6	9	20	60	5.85
SGED290600520	R0.5	6.0	6	9	20	60	5.85
SGED290601020	R1.0	6.0	6	9	20	60	5.85
SGED290800325	R0.3	8.0	8	12	25	65	7.70
SGED290800525	R0.5	8.0	8	12	25	65	7.70
SGED290801025	R1.0	8.0	8	12	25	65	7.70
SGED291000530	R0.5	10.0	10	15	30	70	9.70
SGED291001030	R1.0	10.0	10	15	30	70	9.70
SGED291200532	R0.5	12.0	12	18	32	80	11.70
SGED291201032	R1.0	12.0	12	18	32	80	11.70

Size	Corner Radius Tolerance (mm)	Mill Dia. Tolerance (mm)	Shank Dia. Tolerance
up to Ø6	±0.010	0 ~ - 0.012	h5
over Ø6	±0.015	0 ~ - 0.015	

◎ : Excellent ○ : Good

ISO Material Description	P										M				K								
	Non-alloy steel					Low alloy steel					High alloyed steel, and tool steel				Stainless steel				Grey cast iron		Nodular cast iron		Malleable cast iron
VDI 3323	1	2	3	4	5	6	7	8	9	10	11	12	13	14	15	16	17	18	19	20			
HRc																							
HB	125	190	250	270	300	180	275	300	350	200	325	200	240	180	180	260	160	250	130	230			
Recommend																							
ISO Material Description	N					S					H												
	Aluminum-wrought alloy		Aluminum-cast, alloyed			Copper and Copper Alloys (Bronze / Brass)			Non Metallic Materials		Heat Resistant Super Alloys					Titanium Alloys		Hardened steel	Chilled Cast Iron	Hardened Cast Iron			
VDI 3323	21	22	23	24	25	26	27	28	29	30	31	32	33	34	35	36	37	38	39	40	41		
HRc																							
HB	60	100	75	90	130	110	90	100			200	280	250	350	320	400 Rm	1050 Rm	550	630	400	550		
Recommend	○	○				◎	◎	◎	○														

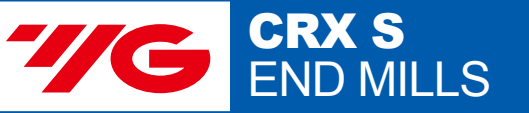

CARBIDE, 2 FLUTE DLC COATING

- **VOLLHARTMETALL, 2 SCHNEIDEN DLC BESCHICHTUNG**
- **Fraise carbure, 2 dents, revêtue DLC**
- **2 TAGLIENTI, RIVESTIMENTO DLC**

- ▶ Designed for copper, copper alloys, soft graphite, reinforced plastics and materials affiliated with non-ferrous metals.
- ▶ Excellent surface roughness from special flute geometry for removing burrs

- ▶ Entwickelt für die Bearbeitung von Kupfer, Kupferlegierungen, sowie faserverstärkten Kunststoffen, NE- Metallen
- ▶ Hervorragende Oberflächenrauheit durch speziell behandelte Nutengeometrie was zur verminderten Gratbildung führt

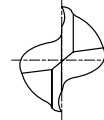

Unit : mm

EDP No.	Mill Diameter	Shank Diameter	Length of Cut	Overall Length
SGED31010	1.0	6	2.5	50
SGED31015	1.5	6	4	50
SGED31020	2.0	6	6	50
SGED31025	2.5	6	8	50
SGED31030	3.0	6	10	50
SGED31040	4.0	6	12	50
SGED31050	5.0	6	15	60
SGED31060	6.0	6	15	60
SGED31080	8.0	8	20	65
SGED31100	10.0	10	25	70
SGED31120	12.0	12	30	80

Size	Mill Dia. Tolerance (mm)	Shank Dia. Tolerance
up to Ø6	0 ~ -0.012	h5
over Ø6	0 ~ -0.015	

◎ : Excellent ○ : Good

ISO Material Description	P											M				K								
	Non-alloy steel					Low alloy steel						High alloyed steel, and tool steel				Stainless steel				Grey cast iron		Nodular cast iron		Malleable cast iron
VDI 3323	1	2	3	4	5	6	7	8	9	10	11	12	13	14	15	16	17	18	19	20				
HRc	13	25	28	32	10	29	32	38	15	35	15	23	10	10	26	3	25	40	21					
HB	125	190	250	270	300	180	275	300	350	200	325	200	240	180	180	260	160	250	130	230				
Recommend																								
ISO Material Description	N										S							H						
	Aluminum-wrought alloy		Aluminum-cast, alloyed			Copper and Copper Alloys (Bronze / Brass)			Non Metallic Materials		Heat Resistant Super Alloys							Titanium Alloys		Hardened steel	Chilled Cast Iron	Hardened Cast Iron		
VDI 3323	21	22	23	24	25	26	27	28	29	30	31	32	33	34	35	36	37	38	39	40	41			
HRc											15	30	25	38	34			55	60	42	55			
HB	60	100	75	90	130	110	90	100			200	280	250	350	320	400 Rm	1050 Rm	550	630	400	550			
Recommend	○	○				◎	◎	◎	○															

CARBIDE, 2 FLUTE DLC COATING with EXTENDED NECK
● VOLLHARTMETALL, 2 SCHNEIDEN DLC BESCHICHTUNG mit ABGESETZTEM SCHAFTTETL
() Fraise carbure, 2 dents, détalonnée, revêtue DLC
() 2 TAGLIANTI, SCARICO ESTESO, RIVESTIMENTO DLC

- ▶ Designed for copper, copper alloys, soft graphite, reinforced plastics and materials affiliated with non-ferrous metals.
- ▶ High toughness and minimized vibration applied from two step taper neck (under dia. 1.0mm)
- ▶ Excellent surface roughness from special flute geometry for removing burrs

- ▶ Entwickelt für die Bearbeitung von Kupfer, Kupferlegierungen, sowie faserverstärkten Kunststoffen, NE- Metallen
- ▶ Hohe Zähigkeit und verminderte Vibrationen werden durch den besonderen kegelförmigen Hals erreicht, (unter Ø 1mm)
- ▶ Hervorragende Oberflächenrauheit durch speziell behandelte Nutengeometrie

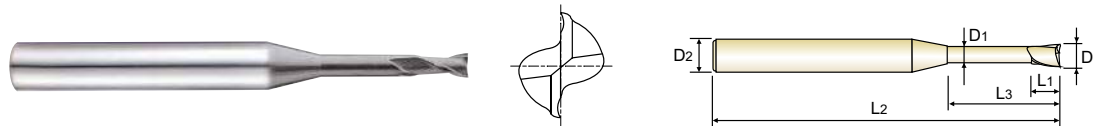

Unit : mm

EDP No.	Mill Diameter	Shank Diameter	Length of Cut	Length Below Shank	Overall Length	Neck Diameter
	D1	D2	L1	L3	L2	D3
SGED3000502	0.5	4	0.7	2	45	0.45
SGED3000504	0.5	4	0.7	4	45	0.45
SGED3000506	0.5	4	0.7	6	45	0.45
SGED3000508	0.5	4	0.7	8	45	0.45
SGED3000510	0.5	4	0.7	10	45	0.45
SGED3000602	0.6	4	0.9	2	45	0.55
SGED3000604	0.6	4	0.9	4	45	0.55
SGED3000606	0.6	4	0.9	6	45	0.55
SGED3000608	0.6	4	0.9	8	45	0.55
SGED3000610	0.6	4	0.9	10	45	0.55
SGED3000804	0.8	4	1.2	4	45	0.75
SGED3000806	0.8	4	1.2	6	45	0.75
SGED3000808	0.8	4	1.2	8	45	0.75
SGED3000810	0.8	4	1.2	10	45	0.75
SGED3000812	0.8	4	1.2	12	45	0.75
SGED3001004	1.0	4	1.5	4	45	0.95
SGED3001006	1.0	4	1.5	6	45	0.95
SGED3001008	1.0	4	1.5	8	45	0.95
SGED3001010	1.0	4	1.5	10	45	0.95
SGED3001012	1.0	4	1.5	12	45	0.95
SGED3001506	1.5	4	2.3	6	45	1.45
SGED3001508	1.5	4	2.3	8	45	1.45
SGED3001510	1.5	4	2.3	10	45	1.45
SGED3001512	1.5	4	2.3	12	45	1.45

▶ NEXT PAGE

Size	Mill Dia. Tolerance (mm)	Shank Dia. Tolerance
up to Ø6	0 ~ -0.012	h5
over Ø6	0 ~ -0.015	

◎ : Excellent ○ : Good

ISO Material Description	P										M				K						
	Non-alloy steel					Low alloy steel					High alloyed steel, and tool steel				Stainless steel		Grey cast iron		Nodular cast iron		Malleable cast iron
VDI 3323	1	2	3	4	5	6	7	8	9	10	11	12	13	14	15	16	17	18	19	20	
HRC																					
HB	125	190	250	270	300	180	275	300	350	200	325	200	240	180	180	260	160	250	130	230	
Recommend																					
ISO Material Description	N					S					H										
	Aluminum-wrought alloy		Aluminum-cast, alloyed			Copper and Copper Alloys (Bronze / Brass)			Non Metallic Materials		Heat Resistant Super Alloys					Titanium Alloys		Hardened steel	Chilled Cast Iron	Hardened Cast Iron	
VDI 3323	21	22	23	24	25	26	27	28	29	30	31	32	33	34	35	36	37	38	39	40	41
HRC																					
HB	60	100	75	90	130	110	90	100			200	280	250	350	320	400 Rm	1050 Rm	550	630	400	550
Recommend	○	○				◎	◎	◎		○											

CARBIDE, 2 FLUTE DLC COATING with EXTENDED NECK

- **VOLLHARTMETALL, 2 SCHNEIDEN DLC BESCHICHTUNG mit ABGESETZTEM SCHAFTTETL**
- 🇩🇪 **Fraise carbure, 2 dents, détalonnée, revêtue DLC**
- 🇮🇹 **2 TAGLIENTI, SCARICO ESTESO, RIVESTIMENTO DLC**

- ▶ Designed for copper, copper alloys, soft graphite, reinforced plastics and materials affiliated with non-ferrous metals.
- ▶ High toughness and minimized vibration applied from two step taper neck (under dia. 1.0mm)
- ▶ Excellent surface roughness from special flute geometry for removing burrs

- ▶ Entwickelt für die Bearbeitung von Kupfer, Kupferlegierungen, sowie faserverstärkten Kunststoffen, NE- Metallen
- ▶ Hohe Zähigkeit und verminderte Vibrationen werden durch den besonderen kegelförmigen Hals erreicht, (unter Ø 1mm)
- ▶ Hervorragende Oberflächenrauheit durch speziell behandelte Nutengeometrie

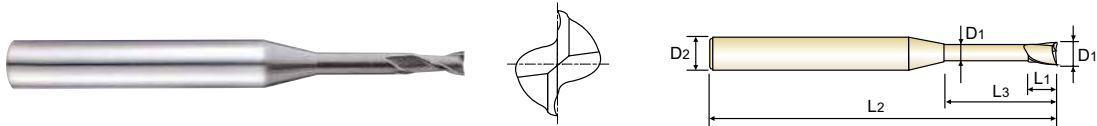

Unit : mm

EDP No.	Mill Diameter	Shank Diameter	Length of Cut	Length Below Shank	Overall Length	Neck Diameter
	D1	D2	L1	L3	L2	D3
SGED3001516	1.5	4	2.3	16	50	1.45
SGED3002008	2.0	4	3	8	45	1.95
SGED3002010	2.0	4	3	10	45	1.95
SGED3002012	2.0	4	3	12	45	1.95
SGED3002016	2.0	4	3	16	50	1.95
SGED3003008	3.0	6	4.5	8	50	2.85
SGED3003010	3.0	6	4.5	10	50	2.85
SGED3003012	3.0	6	4.5	12	50	2.85
SGED3003016	3.0	6	4.5	16	60	2.85
SGED3003020	3.0	6	4.5	20	60	2.85
SGED3004010	4.0	6	6	10	50	3.85
SGED3004012	4.0	6	6	12	50	3.85
SGED3004016	4.0	6	6	16	60	3.85
SGED3004020	4.0	6	6	20	60	3.85
SGED3004025	4.0	6	6	25	60	3.85
SGED3006020	6.0	6	8	20	60	5.85
SGED3006030	6.0	6	8	30	90	5.85
SGED3008020	8.0	8	12	20	70	7.70
SGED3010025	10.0	10	15	25	80	9.70
SGED3012025	12.0	12	18	25	80	11.70

Size	Mill Dia. Tolerance (mm)	Shank Dia. Tolerance
up to Ø6	0 ~ - 0.012	h5
over Ø6	0 ~ - 0.015	

◎ : Excellent ○ : Good

ISO Material Description	P									M							K				
	Non-alloy steel					Low alloy steel				High alloyed steel, and tool steel		Stainless steel					Grey cast iron		Nodular cast iron		Malleable cast iron
VDI 3323	1	2	3	4	5	6	7	8	9	10	11	12	13	14	15	16	17	18	19	20	
HRc	13	25	28	32	10	29	32	38	15	35	15	23	10	10	26	3	25				
HB	125	190	250	270	300	180	275	300	350	200	325	200	240	180	180	260	160	250	130	230	
Recommend																					
ISO Material Description	N										S							H			
	Aluminum-wrought alloy		Aluminum-cast, alloyed			Copper and Copper Alloys (Bronze / Brass)			Non Metallic Materials		Heat Resistant Super Alloys					Titanium Alloys		Hardened steel	Chilled Cast Iron	Hardened Cast Iron	
VDI 3323	21	22	23	24	25	26	27	28	29	30	31	32	33	34	35	36	37	38	39	40	41
HRc											15	30	25	38	34			55	60	42	55
HB	60	100	75	90	130	110	90	100			200	280	250	350	320	400 Rm	1050 Rm	550	630	400	550
Recommend	○	○				◎	◎	◎	○												

Vc = m/min.
fz = mm/tooth
RPM = rev./min.
FEED = mm/min.

SGED28 SERIES 2 FLUTE BALL

ISO	VDI 3323	Material Description	Ae	Ap	Parameter	Diameter (Ø)												
						1.0	2.0	3.0	4.0	5.0	6.0	8.0	10.0	12.0				
N	21-22	Aluminum-wrought alloy	0.05D	0.02D	Vc	155	300	295	285	290	295	300	300	300				
					fz	0.01	0.022	0.031	0.042	0.052	0.061	0.079	0.101	0.12				
					RPM	49338	47746	31300	22680	18462	15650	11937	9549	7958				
	26-28	Copper and Copper Alloys (Bronze / Brass)	0.05D	0.02D	Vc	130	150	150	145	145	145	150	150	150				
					fz	0.011	0.02	0.028	0.038	0.047	0.055	0.072	0.092	0.109				
					RPM	41380	23873	15915	11539	9231	7692	5968	4775	3979				
	29.1	Duroplastic	0.05D	0.02D	Vc	155	315	445	435	440	445	450	455	450				
					fz	0.008	0.015	0.019	0.026	0.033	0.038	0.05	0.063	0.076				
					RPM	49338	50134	47216	34616	28011	23608	17905	14483	11937				
FEED	987	2101	1941	1905	1920	1909	1886	1929	1910	910	955	891	877	868	846	859	879	867

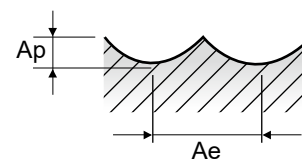

SGED29 SERIES 2 FLUTE CORNER RADIUS - SLOTTING

ISO	VDI 3323	Material Description	Ae	Ap	Parameter	Diameter (Ø)								
						1.0	2.0	3.0	4.0	5.0	6.0	8.0	10.0	12.0
N	21-22	Aluminum-wrought alloy	1.0D	0.5D	Vc	155	315	470	630	785	840	840	840	835
					fz	0.01	0.018	0.026	0.037	0.043	0.052	0.068	0.089	0.105
					RPM	49338	50134	49869	50134	49975	44563	33423	26738	22149
	26-28	Copper and Copper Alloys (Bronze / Brass)	1.0D	0.5D	Vc	155	315	420	420	425	420	420	420	420
					fz	0.01	0.017	0.026	0.031	0.039	0.047	0.063	0.079	0.095
					RPM	49338	50134	44563	33423	27056	22282	16711	13369	11141
	29.1	Duroplastic	1.0D	0.5D	Vc	155	315	470	630	785	940	1255	1255	1265
					fz	0.007	0.014	0.021	0.026	0.034	0.042	0.057	0.069	0.084
					RPM	49338	50134	49869	50134	49975	49869	49935	39948	33555
FEED	691	1404	2094	2607	3398	4189	5693	5513	5637					

2 FLUTE CORNER RADIUS - SIDE CUTTING

ISO	VDI 3323	Material Description	Ae	Ap	Parameter	Diameter (Ø)											
						1.0	2.0	3.0	4.0	5.0	6.0	8.0	10.0	12.0			
N	21-22	Aluminum-wrought alloy	0.5D	1.0D	Vc	155	315	470	630	785	940	940	940	940			
					fz	0.014	0.028	0.042	0.053	0.065	0.079	0.105	0.131	0.157			
					RPM	49338	50134	49869	50134	49975	49869	37401	29921	24934			
	26-28	Copper and Copper Alloys (Bronze / Brass)	0.5D	1.0D	Vc	155	315	470	630	630	630	630	630	630			
					fz	0.012	0.025	0.037	0.047	0.06	0.073	0.094	0.12	0.141			
					RPM	49338	50134	49869	50134	40107	33423	25067	20054	16711			
	29.1	Duroplastic	0.5D	1.0D	Vc	155	315	470	630	785	940	1255	1255	1265			
					fz	0.012	0.025	0.037	0.05	0.065	0.075	0.084	0.105	0.125			
					RPM	49338	50134	49869	50134	49975	49869	49935	39948	33555			
FEED	1184	2507	3690	4713	4813	4880	4713	4813	4713	1184	2507	3690	5013	6497	7480	8389	8389

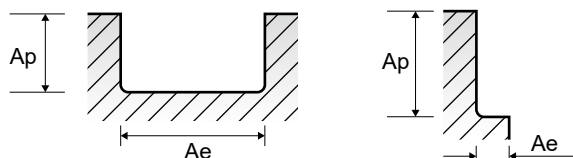

SGED27 SERIES 2 FLUTE BALL

Vc = m/min.
fz = mm/tooth
RPM = rev./min.
FEED = mm/min.

ISO	VDI 3323	Material Description	Ae	Ap	Parameter	Diameter (Ø)											
						0.5	0.6	0.8	1.0	2.0	3.0	4.0	5.0	6.0	8.0	10.0	12.0
N	21	Aluminum-wrought alloy	0.05D	0.02D	Vc	80	95	125	155	250	245	240	240	245	250	250	250
					fz	0.005	0.007	0.009	0.01	0.022	0.03	0.042	0.052	0.061	0.079	0.1	0.122
					RPM	50930	50399	49736	49338	39789	25995	19099	15279	12998	9947	7958	6631
					FEED	509	706	895	987	1751	1560	1604	1589	1586	1572	1592	1618
N	26-28	Copper and Copper Alloys (Bronze / Brass)	0.05D	0.02D	Vc	80	95	110	110	125	125	120	120	125	125	125	125
					fz	0.005	0.007	0.009	0.011	0.02	0.028	0.038	0.047	0.055	0.072	0.091	0.111
					RPM	50930	50399	43768	35014	19894	13263	9549	7639	6631	4974	3979	3316
					FEED	509	706	788	770	796	743	726	718	729	716	724	736
N	29.1	Duroplastic	0.05D	0.02D	Vc	80	95	125	155	315	370	360	365	370	375	375	375
					fz	0.004	0.005	0.006	0.006	0.013	0.019	0.027	0.033	0.039	0.05	0.064	0.077
					RPM	50930	50399	49736	49338	50134	39258	28648	23237	19629	14921	11937	9947
					FEED	407	504	597	592	1303	1492	1547	1534	1531	1492	1528	1532

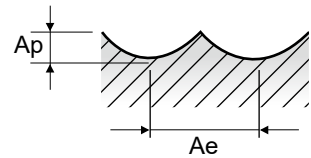

SGED30, SGED31 SERIES

2 FLUTE - SLOTTING

ISO	VDI 3323	Material Description	Ae	Ap	Parameter	Diameter (Ø)										
						0.5	0.6	0.8	1.0	2.0	3.0	4.0	6.0	8.0	10.0	12.0
N	21-22	Aluminum-wrought alloy	1.0D	0.5D	Vc	80	95	125	155	315	330	325	325	330	325	330
					fz	0.005	0.006	0.008	0.01	0.01	0.023	0.032	0.048	0.064	0.081	0.097
					RPM	50930	50399	49736	49338	50134	35014	25863	17242	13130	10345	8754
					FEED	509	605	796	987	1003	1611	1655	1655	1681	1676	1698
N	26-28	Copper and Copper Alloys (Bronze / Brass)	1.0D	0.5D	Vc	80	95	105	110	160	165	160	165	165	160	165
					fz	0.005	0.006	0.008	0.01	0.01	0.023	0.032	0.048	0.064	0.081	0.097
					RPM	50930	50399	41778	35014	25465	17507	12732	8754	6565	5093	4377
					FEED	509	605	668	700	509	805	815	840	840	825	849
N	29.1	Duroplastic	1.0D	0.5D	Vc	80	95	125	155	315	470	490	490	500	490	495
					fz	0.001	0.002	0.002	0.003	0.004	0.007	0.009	0.014	0.018	0.023	0.028
					RPM	50930	50399	49736	49338	50134	49869	38993	25995	19894	15597	13130
					FEED	102	202	199	296	401	698	702	728	716	717	735

2 FLUTE - SIDE CUTTING

ISO	VDI 3323	Material Description	Ae	Ap	Parameter	Diameter (Ø)										
						0.5	0.6	0.8	1.0	2.0	3.0	4.0	6.0	8.0	10.0	12.0
N	21-22	Aluminum-wrought alloy	0.5D	1.0D	Vc	80	95	125	130	260	260	265	270	265	265	270
					fz	0.005	0.006	0.008	0.01	0.011	0.025	0.034	0.053	0.069	0.086	0.107
					RPM	50930	50399	49736	41380	41380	27587	21088	14324	10544	8435	7162
					FEED	509	605	796	828	910	1379	1434	1518	1455	1451	1533
N	26-28	Copper and Copper Alloys (Bronze / Brass)	0.5D	1.0D	Vc	80	85	85	85	170	175	175	180	175	175	180
					fz	0.005	0.006	0.008	0.01	0.01	0.023	0.032	0.05	0.064	0.08	0.1
					RPM	50930	45094	33820	27056	27056	18568	13926	9549	6963	5570	4775
					FEED	509	541	541	541	541	854	891	955	891	891	955
N	29.1	Duroplastic	0.5D	1.0D	Vc	80	95	125	155	315	350	350	360	350	350	360
					fz	0.004	0.005	0.006	0.008	0.009	0.018	0.026	0.04	0.051	0.064	0.08
					RPM	50930	50399	49736	49338	50134	37136	27852	19099	13926	11141	9549
					FEED	407	504	597	789	902	1337	1448	1528	1420	1426	1528

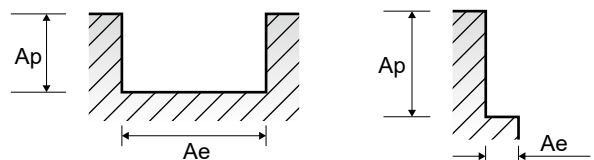



Leading Through Innovation

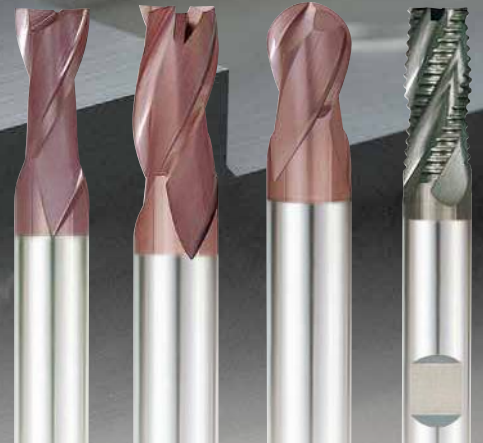

SOLID CARBIDE

K-2 END MILLS

K-2 VHM - Fräser

- General Purpose / Conventional or High Speed Milling / Wet & Dry Cutting
- Für allgemeinen Einsatz / Konventionelles oder Hochgeschwindigkeitsfräsen

SELECTION GUIDE



SERIES	G9624	G9A70	G9437	G9438
FLUTE	2	2	2	2
HELIX ANGLE	30°	30°	≈ 30°	≈ 30°
CUTTING EDGE SHAPE	BALL NOSE	BALL NOSE	BALL NOSE	BALL NOSE
SIZE MIN	R1.0	R0.5	R1.0	R1.0
SIZE MAX	R10.0	R10.0	R10.0	R10.0
PAGE	548	549	550	551

SOLID CARBIDE
K-2
END MILLS

General Purpose
Conventional or High Speed Milling
Wet & Dry Cutting

SHORT LENGTH	SHORT LENGTH	SHORT LENGTH	LONG LENGTH
TiAlN based	TiAlN based	TiAlN based	TiAlN based



Please visit
globalyg1.com/mat
for material search

◎ : Excellent ○ : Good

Recommended cutting conditions : P 597

ISO	VDI 3323	Material Description	Composition / Structure / Heat Treatment	HB	HRc					
P	1	Non-alloy steel	About 0.15% C Annealed	125		◎	◎	◎	◎	
	2		About 0.45% C Annealed	190	13	◎	◎	◎	◎	
	3		About 0.45% C Quenched & Tempered	250	25	◎	◎	◎	◎	
	4		About 0.75% C Annealed	270	28	◎	◎	◎	◎	
	5		About 0.75% C Quenched & Tempered	300	32	◎	◎	◎	◎	
	6	Low alloy steel	Annealed	180	10	◎	◎	◎	◎	
	7		Quenched & Tempered	275	29	◎	◎	◎	◎	
	8		Quenched & Tempered	300	32	◎	◎	◎	◎	
	9		Quenched & Tempered	350	38	◎	◎	◎	◎	
	10		High alloyed steel, and tool steel	Annealed	200	15	◎	◎	◎	◎
	11			Quenched & Tempered	325	35	◎	◎	◎	◎
M	12	Stainless steel	Ferritic / Martensitic Annealed	200	15	○	○	○	○	
	13		Martensitic Quenched & Tempered	240	23	○	○	○	○	
	14		Austenitic	180	10	○	○	○	○	
K	15	Grey cast iron	Pearlitic / ferritic	180	10	○	○	○	○	
	16		Pearlitic (Martensitic)	260	26	○	○	○	○	
	17	Nodular cast iron	Ferritic	160	3	○	○	○	○	
	18		Pearlitic	250	25	○	○	○	○	
	19		Ferritic	130		○	○	○	○	
20	Malleable cast iron	Pearlitic	230	21	○	○	○	○		
N	21	Aluminum-wrought alloy	Not Curable	60		○	○	○	○	
	22		Curable Hardened	100		○	○	○	○	
	23	Aluminum-cast, alloyed	≤ 12% Si, Not Curable	75		○	○	○	○	
	24		≤ 12% Si, Curable Hardened	90		○	○	○	○	
	25		> 12% Si, Not Curable	130		○	○	○	○	
	26	Copper and Copper Alloys (Bronze / Brass)	Cutting Alloys, PB>1%	110		○	○	○	○	
	27		CuZn, CuSnZn (Brass)	90		○	○	○	○	
	28		CuSn, lead-free copper and electrolytic copper	100		○	○	○	○	
	29	Non Metallic Materials	Duroplastic, Fiber Reinforced Plastic							
	30		Rubber, Wood, etc.							
S	31	Heat Resistant Super Alloys	Fe Based Annealed	200	15	○	○	○	○	
	32		Cured	280	30	○	○	○	○	
	33		Annealed	250	25	○	○	○	○	
	34		Ni or Co Based Cured	350	38	○	○	○	○	
	35	Cast	320	34	○	○	○	○		
	36	Titanium Alloys	Pure Titanium	400 Rm		○	○	○	○	
	37		Alpha + Beta Alloys Hardened	1050 Rm		○	○	○	○	
H	38	Hardened steel	Hardened	550	55					
	39		Hardened	630	60					
	40	Chilled Cast Iron	Cast	400	42	○	○	○	○	
	41	Hardened Cast Iron	Hardened	550	55					

G9454	G9455	G9B81	G9634	G9B82	G9B83	G9B84	G9B85	G9424	G9G44	G9A68
2	2	2	4	2	2	4	4	2	2	2
30°	30°	30°	30°	30°	30°	30°	30°	30°	30°	30°
BALL NOSE	BALL NOSE	BALL NOSE	BALL NOSE	CORNER RADIUS	CORNER RADIUS	CORNER RADIUS	CORNER RADIUS	SQUARE	SQUARE	SQUARE
R1.5	R1.5	R0.2	R1.0	D2.0	D3.0	D2.0	D3.0	D1.0	D3.0	D1.0
R10.0	R10.0	R2.0	R10.0	D12.0	D12.0	D12.0	D12.0	D20.0	D20.0	D20.0
552	553	554	556	557	559	560	562	563	564	565
LONG REACH	EXTRA LONG LENGTH	RIB PROCESSING	SHORT LENGTH	SHORT LENGTH	LONG REACH	SHORT LENGTH	LONG REACH	SHORT LENGTH	SHORT LENGTH WITH CHAMFER	SHORT LENGTH
TiAlN based	TiAlN based	TiAlN based	TiAlN based	TiAlN based	TiAlN based	TiAlN based	TiAlN based	TiAlN based	TiAlN based	TiAlN based



○	○	○	○	○	○	○	○	○	○	○	1
○	○	○	○	○	○	○	○	○	○	○	2
○	○	○	○	○	○	○	○	○	○	○	3
○	○	○	○	○	○	○	○	○	○	○	4
○	○	○	○	○	○	○	○	○	○	○	5
○	○	○	○	○	○	○	○	○	○	○	6 P
○	○	○	○	○	○	○	○	○	○	○	7
○	○	○	○	○	○	○	○	○	○	○	8
○	○	○	○	○	○	○	○	○	○	○	9
○	○	○	○	○	○	○	○	○	○	○	10
○	○	○	○	○	○	○	○	○	○	○	11
○	○	○	○	○	○	○	○	○	○	○	12
○	○	○	○	○	○	○	○	○	○	○	13 M
○	○	○	○	○	○	○	○	○	○	○	14
○	○	○	○	○	○	○	○	○	○	○	15
○	○	○	○	○	○	○	○	○	○	○	16
○	○	○	○	○	○	○	○	○	○	○	17 K
○	○	○	○	○	○	○	○	○	○	○	18
○	○	○	○	○	○	○	○	○	○	○	19
○	○	○	○	○	○	○	○	○	○	○	20
○	○	○	○	○	○	○	○	○	○	○	21
○	○	○	○	○	○	○	○	○	○	○	22
○	○	○	○	○	○	○	○	○	○	○	23
○	○	○	○	○	○	○	○	○	○	○	24
○	○	○	○	○	○	○	○	○	○	○	25 N
○	○	○	○	○	○	○	○	○	○	○	26
○	○	○	○	○	○	○	○	○	○	○	27
○	○	○	○	○	○	○	○	○	○	○	28
○	○	○	○	○	○	○	○	○	○	○	29
○	○	○	○	○	○	○	○	○	○	○	30
○	○	○	○	○	○	○	○	○	○	○	31
○	○	○	○	○	○	○	○	○	○	○	32
○	○	○	○	○	○	○	○	○	○	○	33
○	○	○	○	○	○	○	○	○	○	○	34 S
○	○	○	○	○	○	○	○	○	○	○	35
○	○	○	○	○	○	○	○	○	○	○	36
○	○	○	○	○	○	○	○	○	○	○	37
○	○	○	○	○	○	○	○	○	○	○	38
○	○	○	○	○	○	○	○	○	○	○	39 H
○	○	○	○	○	○	○	○	○	○	○	40
○	○	○	○	○	○	○	○	○	○	○	41

HSS

CBN END MILLS

i-Xmill END MILLS

i-SMART MODULAR END MILLS

X5070 END MILLS

4G MILL END MILLS

X-POWER PRO END MILLS

TitaNox-POWER END MILLS

JET-POWER END MILLS

V7 PLUS END MILLS

ALU-POWER HPC END MILLS

ALU-POWER END MILLS

D-POWER GRAPHITE END MILLS

D-POWER CFRP END MILLS

ROUTERS

CRX S END MILLS

K-2 END MILLS

ONLY ONE COATED PM60 END MILLS

TANK-POWER END MILLS

GENERAL HSS END MILLS

MILLING CUTTERS

TECHNICAL DATA

SELECTION GUIDE



SERIES	G9444	G9527	G9445	G9G45
FLUTE	2	2	2	2
HELIX ANGLE	≈ 30°	≈ 30°	≈ 30°	≈ 30°
CUTTING EDGE SHAPE	SQUARE	SQUARE	SQUARE	SQUARE
SIZE MIN	D2.0	D3.5	D2.0	D3.0
SIZE MAX	D20.0	D20.0	D20.0	D20.0
PAGE	566	567	568	570

**SOLID CARBIDE
K-2
END MILLS**

General Purpose with Coating
Conventional or High Speed Milling, Wet or Dry Cutting

SHORT LENGTH	LONG LENGTH	LONG LENGTH	LONG LENGTH with CHAMFER
TiAlN based	TiAlN based	TiAlN based	TiAlN based



Please visit globalyg1.com/mat for material search

◎ : Excellent ○ : Good

Recommended cutting conditions : P 597

ISO	VDI 3323	Material Description	Composition / Structure / Heat Treatment	HB	HRc					
P	1	Non-alloy steel	About 0.15% C Annealed	125		◎	◎	◎	◎	
	2		About 0.45% C Annealed	190	13	◎	◎	◎	◎	
	3		About 0.45% C Quenched & Tempered	250	25	◎	◎	◎	◎	
	4		About 0.75% C Annealed	270	28	◎	◎	◎	◎	
	5		About 0.75% C Quenched & Tempered	300	32	◎	◎	◎	◎	
	6	Low alloy steel	Annealed	180	10	◎	◎	◎	◎	
	7		Quenched & Tempered	275	29	◎	◎	◎	◎	
	8		Quenched & Tempered	300	32	◎	◎	◎	◎	
	9		Quenched & Tempered	350	38	◎	◎	◎	◎	
	10		High alloyed steel, and tool steel	Annealed	200	15	◎	◎	◎	◎
	11			Quenched & Tempered	325	35	◎	◎	◎	◎
M	12	Stainless steel	Ferritic / Martensitic Annealed	200	15	○	○	○	○	
	13		Martensitic Quenched & Tempered	240	23	○	○	○	○	
	14	Austenitic	180	10	○	○	○	○		
K	15	Grey cast iron	Pearlitic / ferritic	180	10	○	○	○	○	
	16		Pearlitic (Martensitic)	260	26	○	○	○	○	
	17	Nodular cast iron	Ferritic	160	3	○	○	○	○	
	18		Pearlitic	250	25	○	○	○	○	
	19		Ferritic	130		○	○	○	○	
20	Malleable cast iron	Pearlitic	230	21	○	○	○	○		
N	21	Aluminum-wrought alloy	Not Curable	60		○	○	○	○	
	22		Curable Hardened	100		○	○	○	○	
	23	Aluminum-cast, alloyed	≤ 12% Si, Not Curable	75		○	○	○	○	
	24		≤ 12% Si, Curable Hardened	90		○	○	○	○	
	25		> 12% Si, Not Curable	130		○	○	○	○	
	26		Cutting Alloys, PB>1%	110		○	○	○	○	
	27	Copper and Copper Alloys (Bronze / Brass)	CuZn, CuSnZn (Brass)	90		○	○	○	○	
	28		CuSn, lead-free copper and electrolytic copper	100		○	○	○	○	
	29	Non Metallic Materials	Duroplastic, Fiber Reinforced Plastic			○	○	○	○	
	30		Rubber, Wood, etc.							
S	31	Heat Resistant Super Alloys	Fe Based Annealed	200	15	○	○	○	○	
	32		Cured	280	30	○	○	○	○	
	33		Annealed	250	25	○	○	○	○	
	34		Ni or Co Based Cured	350	38	○	○	○	○	
	35	Cast	320	34	○	○	○	○		
	36	Titanium Alloys	Pure Titanium	400 Rm		○	○	○	○	
	37		Alpha + Beta Alloys Hardened	1050 Rm		○	○	○	○	
H	38	Hardened steel	Hardened	550	55					
	39		Hardened	630	60					
	40	Chilled Cast Iron	Cast	400	42	○	○	○	○	
	41	Hardened Cast Iron	Hardened	550	55					

G9452	G9B80	G9410 G9553	G9G46	G9425	G9G47	G9439	G9528	G9433	G9G48	G9447
2	2	3	3	3	3	3	3	3	3	3
30°	30°	30°	30°	30°	30°	≈ 30°	≈ 30°	≈ 30°	≈ 30°	45°
SQUARE	SQUARE	SQUARE	SQUARE	SQUARE	SQUARE	SQUARE	SQUARE	SQUARE	SQUARE	SQUARE
D3.0	D0.4	D0.5	D3.0	D1.0	D3.0	D2.0	D3.5	D3.0	D3.0	D3.0
D20.0	D4.0	D20.0	D20.0	D20.0	D20.0	D20.0	D20.0	D20.0	D20.0	D20.0
571	572	575	577	578	579	580	581	582	583	584
EXTRA LONG LENGTH	RIB PROCESSING	THROW AWAY	THROW AWAY with CHAMFER	SHORT LENGTH	SHORT LENGTH with CHAMFER	SHORT LENGTH	LONG LENGTH	LONG LENGTH	LONG LENGTH with CHAMFER	LONG LENGTH
TiAlN based	TiAlN based	TiAlN based	TiAlN based	TiAlN based	TiAlN based	TiAlN based	TiAlN based	TiAlN based	TiAlN based	TiAlN based

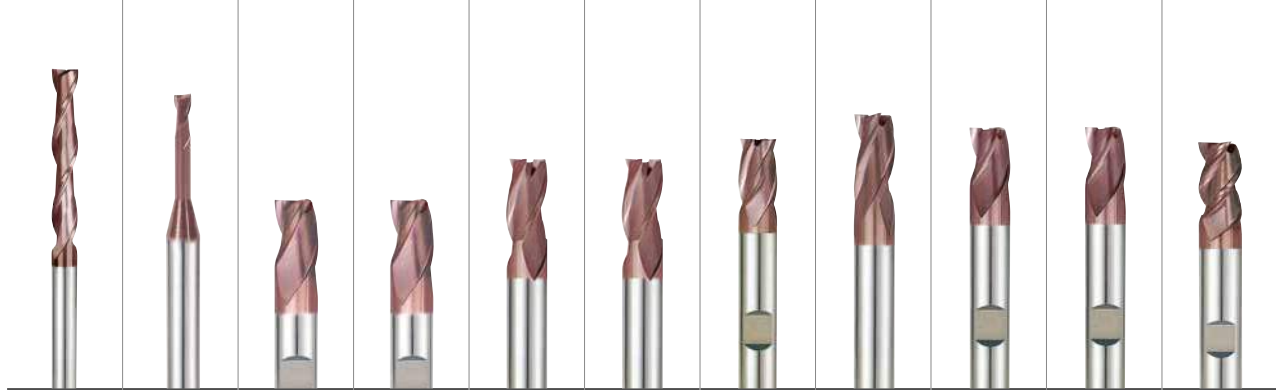

○	○	○	○	○	○	○	○	○	○	○	1
○	○	○	○	○	○	○	○	○	○	○	2
○	○	○	○	○	○	○	○	○	○	○	3
○	○	○	○	○	○	○	○	○	○	○	4
○	○	○	○	○	○	○	○	○	○	○	5
○	○	○	○	○	○	○	○	○	○	○	6 P
○	○	○	○	○	○	○	○	○	○	○	7
○	○	○	○	○	○	○	○	○	○	○	8
○	○	○	○	○	○	○	○	○	○	○	9
○	○	○	○	○	○	○	○	○	○	○	10
○	○	○	○	○	○	○	○	○	○	○	11
○	○	○	○	○	○	○	○	○	○	○	12
○	○	○	○	○	○	○	○	○	○	○	13 M
○	○	○	○	○	○	○	○	○	○	○	14
○	○	○	○	○	○	○	○	○	○	○	15
○	○	○	○	○	○	○	○	○	○	○	16
○	○	○	○	○	○	○	○	○	○	○	17 K
○	○	○	○	○	○	○	○	○	○	○	18
○	○	○	○	○	○	○	○	○	○	○	19
○	○	○	○	○	○	○	○	○	○	○	20
○	○	○	○	○	○	○	○	○	○	○	21
○	○	○	○	○	○	○	○	○	○	○	22
○	○	○	○	○	○	○	○	○	○	○	23
○	○	○	○	○	○	○	○	○	○	○	24
○	○	○	○	○	○	○	○	○	○	○	25 N
○	○	○	○	○	○	○	○	○	○	○	26
○	○	○	○	○	○	○	○	○	○	○	27
○	○	○	○	○	○	○	○	○	○	○	28
○	○	○	○	○	○	○	○	○	○	○	29
○	○	○	○	○	○	○	○	○	○	○	30
○	○	○	○	○	○	○	○	○	○	○	31
○	○	○	○	○	○	○	○	○	○	○	32
○	○	○	○	○	○	○	○	○	○	○	33
○	○	○	○	○	○	○	○	○	○	○	34 S
○	○	○	○	○	○	○	○	○	○	○	35
○	○	○	○	○	○	○	○	○	○	○	36
○	○	○	○	○	○	○	○	○	○	○	37
○	○	○	○	○	○	○	○	○	○	○	38
○	○	○	○	○	○	○	○	○	○	○	39 H
○	○	○	○	○	○	○	○	○	○	○	40
○	○	○	○	○	○	○	○	○	○	○	41

HSS

CBN END MILLS

i-Xmill END MILLS

i-SMART MODULAR END MILLS

X5070 END MILLS

4G MILL END MILLS

X-POWER PRO END MILLS

TitaNox-POWER END MILLS

JET-POWER END MILLS

V7 PLUS END MILLS

ALU-POWER HPC END MILLS

ALU-POWER END MILLS

D-POWER GRAPHITE END MILLS

D-POWER CFRP END MILLS

ROUTERS

CRX S END MILLS

K-2 END MILLS

ONLY ONE COATED PM60 END MILLS

TANK-POWER END MILLS

GENERAL HSS END MILLS

MILLING CUTTERS

TECHNICAL DATA

SELECTION GUIDE



SERIES	G9G49	G9432	G9G50
FLUTE	3	4	4
HELIX ANGLE	45°	30°	30°
CUTTING EDGE SHAPE	SQUARE	SQUARE	SQUARE
SIZE MIN	D3.0	D1.0	D3.0
SIZE MAX	D20.0	D20.0	D20.0
PAGE	585	586	587

SOLID CARBIDE
K-2
END MILLS

General Purpose with Coating
Conventional or High Speed Milling, Wet or Dry Cutting

LONG LENGTH with CHAMFER	SHORT LENGTH	SHORT LENGTH with CHAMFER
TiAlN based	TiAlN based	TiAlN based

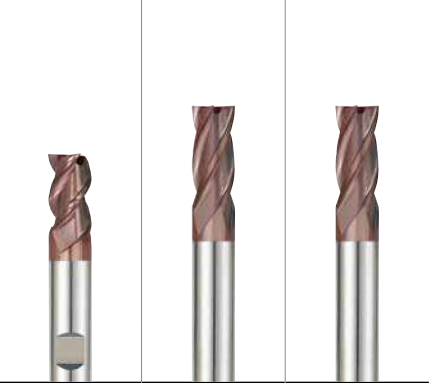

Please visit globalyg1.com/mat for material search

◎ : Excellent ○ : Good

Recommended cutting conditions : P 597

ISO	VDI 3323	Material Description	Composition / Structure / Heat Treatment	HB	HRc	G9G49	G9432	G9G50
P	1	Non-alloy steel	About 0.15% C Annealed	125		◎	◎	◎
	2		About 0.45% C Annealed	190	13	◎	◎	◎
	3		About 0.45% C Quenched & Tempered	250	25	◎	◎	◎
	4		About 0.75% C Annealed	270	28	◎	◎	◎
	5		About 0.75% C Quenched & Tempered	300	32	◎	◎	◎
	6	Low alloy steel	Annealed	180	10	◎	◎	◎
	7		Quenched & Tempered	275	29	◎	◎	◎
	8		Quenched & Tempered	300	32	◎	◎	◎
	9		Quenched & Tempered	350	38	◎	◎	◎
	10		High alloyed steel, and tool steel	Annealed	200	15	◎	◎
	11	Quenched & Tempered		325	35	◎	◎	◎
M	12	Stainless steel	Ferritic / Martensitic Annealed	200	15	○	○	○
	13		Martensitic Quenched & Tempered	240	23	○	○	○
	14		Austenitic	180	10	○	○	○
K	15	Grey cast iron	Pearlitic / ferritic	180	10	○	○	○
	16		Pearlitic (Martensitic)	260	26	○	○	○
	17	Nodular cast iron	Ferritic	160	3	○	○	○
	18		Pearlitic	250	25	○	○	○
	19		Ferritic	130		○	○	○
20	Malleable cast iron	Pearlitic	230	21	○	○	○	
N	21	Aluminum-wrought alloy	Not Curable	60		○	○	○
	22		Curable Hardened	100		○	○	○
	23	Aluminum-cast, alloyed	≤ 12% Si, Not Curable	75		○	○	○
	24		≤ 12% Si, Curable Hardened	90		○	○	○
	25		> 12% Si, Not Curable	130		○	○	○
	26		Cutting Alloys, PB>1%	110		○	○	○
	27	Copper and Copper Alloys (Bronze / Brass)	CuZn, CuSnZn (Brass)	90		○	○	○
	28		CuSn, lead-free copper and electrolytic copper	100		○	○	○
	29	Non Metallic Materials	Duroplastic, Fiber Reinforced Plastic			○	○	○
	30		Rubber, Wood, etc.			○	○	○
S	31	Heat Resistant Super Alloys	Fe Based Annealed	200	15	○	○	○
	32		Fe Based Cured	280	30	○	○	○
	33		Ni or Co Based Annealed	250	25	○	○	○
	34		Ni or Co Based Cured	350	38	○	○	○
	35	Cast	320	34	○	○	○	
	36	Titanium Alloys	Pure Titanium	400 Rm		○	○	○
	37		Alpha + Beta Alloys Hardened	1050 Rm		○	○	○
H	38	Hardened steel	Hardened	550	55			
	39		Hardened	630	60			
	40	Chilled Cast Iron	Cast	400	42	○	○	○
	41	Hardened Cast Iron	Hardened	550	55			

G9A69	G9448	G9540	G9449	G9G51	G9453	G9F45 G9F46	G9A42	G9400
4	4	4	4	4	4	4&6	Multi Flute	2
30°	≈ 30°	≈ 30°	≈ 30°	≈ 30°	30°	45°	30°	30°
SQUARE	SQUARE	SQUARE	SQUARE	SQUARE	SQUARE	SQUARE	ROUGHING	DRILL MILL
D1.0	D2.0	D3.5	D2.0	D3.0	D3.0	D3.0	D6.0	D3.0
D20.0	D20.0	D20.0	D20.0	D20.0	D20.0	D20.0	D25.0	D20.0
588	589	590	591	592	593	594	595	596
SHORT LENGTH	SHORT LENGTH	LONG LENGTH	LONG LENGTH	LONG LENGTH with CHAMFER	EXTRA LONG LENGTH	SHORT LENGTH LONG LENGTH	LONG LENGTH	-
TiAlN based	TiAlN based	TiAlN based	TiAlN based	TiAlN based	TiAlN based	TiAlN based	X-Coating	TiAlN based

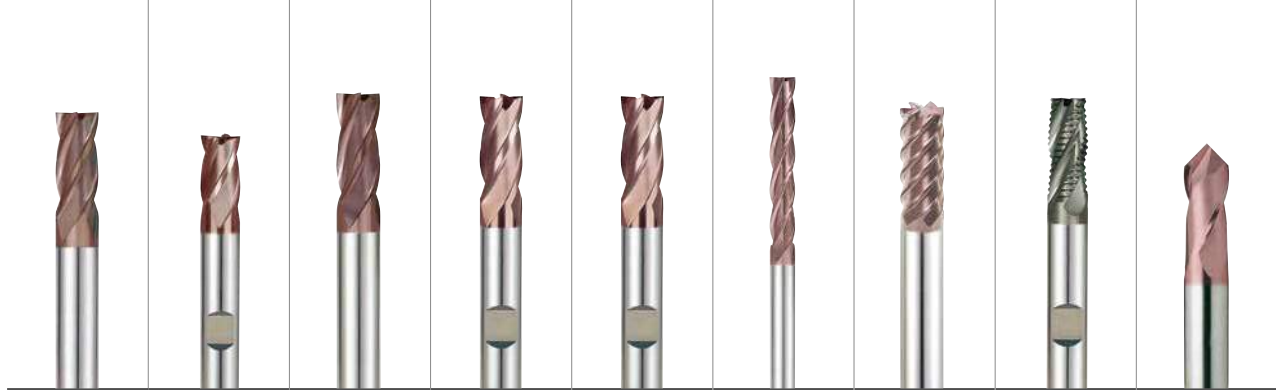

○	○	○	○	○	○	○	○	○	1
○	○	○	○	○	○	○	○	○	2
○	○	○	○	○	○	○	○	○	3
○	○	○	○	○	○	○	○	○	4
○	○	○	○	○	○	○	○	○	5
○	○	○	○	○	○	○	○	○	6 P
○	○	○	○	○	○	○	○	○	7
○	○	○	○	○	○	○	○	○	8
○	○	○	○	○	○	○	○	○	9
○	○	○	○	○	○	○	○	○	10
○	○	○	○	○	○	○	○	○	11
○	○	○	○	○	○	○	○	○	12
○	○	○	○	○	○	○	○	○	13 M
○	○	○	○	○	○	○	○	○	14
○	○	○	○	○	○	○	○	○	15
○	○	○	○	○	○	○	○	○	16
○	○	○	○	○	○	○	○	○	17 K
○	○	○	○	○	○	○	○	○	18
○	○	○	○	○	○	○	○	○	19
○	○	○	○	○	○	○	○	○	20
○	○	○	○	○	○	○	○	○	21
○	○	○	○	○	○	○	○	○	22
○	○	○	○	○	○	○	○	○	23
○	○	○	○	○	○	○	○	○	24
○	○	○	○	○	○	○	○	○	25 N
○	○	○	○	○	○	○	○	○	26
○	○	○	○	○	○	○	○	○	27
○	○	○	○	○	○	○	○	○	28
○	○	○	○	○	○	○	○	○	29
○	○	○	○	○	○	○	○	○	30
○	○	○	○	○	○	○	○	○	31
○	○	○	○	○	○	○	○	○	32
○	○	○	○	○	○	○	○	○	33
○	○	○	○	○	○	○	○	○	34 S
○	○	○	○	○	○	○	○	○	35
○	○	○	○	○	○	○	○	○	36
○	○	○	○	○	○	○	○	○	37
○	○	○	○	○	○	○	○	○	38
○	○	○	○	○	○	○	○	○	39 H
○	○	○	○	○	○	○	○	○	40
○	○	○	○	○	○	○	○	○	41

HSS

CBN
END MILLS

i-Xmill
END MILLS

i-SMART
MODULAR
END MILLS

X5070
END MILLS

4G MILL
END MILLS

X-POWER
PRO
END MILLS

TitaNox-
POWER
END MILLS

JET-POWER
END MILLS

V7 PLUS
END MILLS

ALU-POWER
HPC
END MILLS

ALU-
POWER
END MILLS

D-POWER
GRAPHITE
END MILLS

D-POWER
CFRP
END MILLS

ROUTERS

CRX S
END MILLS

K-2
END MILLS

ONLY ONE
COATED PM60
END MILLS

TANK-
POWER
END MILLS

GENERAL
HSS
END MILLS

MILLING
CUTTERS

TECHNICAL
DATA

CARBIDE, 2 FLUTE SHORT LENGTH BALL NOSE

- **VOLLHARTMETALL, 2 SCHNEIDEN KURZ STIRNRADIUS**
- **Fraise carbure, 2 dents, hémisphérique, courte**
- **2 TAGLIENTI, SEMISFERICA, SERIE CORTA**

- ▶ Suitable for dry milling applications at high temperatures.
- ▶ Excellent high-performance end mills.
- ▶ Designed for milling of radius bottom slots, fillets and special contours.

- ▶ Für die Trockenbearbeitung.
- ▶ Hervorragendes Preis - Leistungsverhältnis.
- ▶ Bestimmt für das Fräsen von Nuten mit konvexem Grund, Sonderprofilen und zum Kopieren.

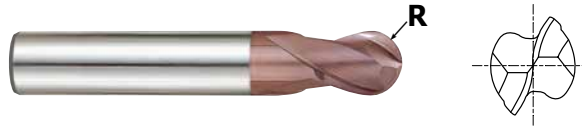

CARBIDE
2
30°
R ±0.02
DIN 6535HA
P.597

Unit : mm

EDP No.	Radius of Ball Nose	Mill Diameter	Shank Diameter	Length of Cut	Overall Length
	R (±0.02)				
G9624020	R1.0	2.0	6	4	48
G9624025	R1.25	2.5	6	4	48
G9624030	R1.5	3.0	6	4	48
G9624040	R2.0	4.0	6	6	50
G9624901	R2.0	4.0	4	12	40
G9624050	R2.5	5.0	6	7	51
G9624902	R2.5	5.0	5	14	50
G9624060	R3.0	6.0	6	7	51
G9624080	R4.0	8.0	8	9	59
G9624100	R5.0	10.0	10	10	60
G9624120	R6.0	12.0	12	14	71
G9624140	R7.0	14.0	14	14	71
G9624160	R8.0	16.0	16	16	76
G9624180	R9.0	18.0	18	18	76
G9624200	R10.0	20.0	20	20	82

Mill Dia. Tolerance(mm)	Shank Dia. Tolerance
0 ~ - 0.03	h5

◎ : Excellent ○ : Good

ISO Material Description	P											M			K						
	Non-alloy steel					Low alloy steel				High alloyed steel, and tool steel		Stainless steel			Grey cast iron		Nodular cast iron		Malleable cast iron		
VDI 3323	1	2	3	4	5	6	7	8	9	10	11	12	13	14	15	16	17	18	19	20	
HRc	13	25	28	32	10	29	32	38	15	35	15	23	10	10	26	3	25		21		
HB	125	190	250	270	300	180	275	300	350	200	325	200	240	180	180	260	160	250	130	230	
Recommend	◎	◎	◎	◎	◎	◎	◎	◎	◎	◎	◎	○	○	○	○	○	○	○	○	○	
ISO Material Description	N										S						H				
	Aluminum-wrought alloy		Aluminum-cast, alloyed			Copper and Copper Alloys (Bronze / Brass)			Non Metallic Materials		Heat Resistant Super Alloys						Titanium Alloys		Hardened steel	Chilled Cast Iron	Hardened Cast Iron
VDI 3323	21	22	23	24	25	26	27	28	29	30	31	32	33	34	35	36	37	38	39	40	41
HRc											15	30	25	38	34			55	60	42	55
HB	60	100	75	90	130	110	90	100			200	280	250	350	320	400 Rm	1050 Rm	550	630	400	550
Recommend	○	○	○	○	○	○	○	○			○	○	○	○	○	○	○	○	○	○	○

CARBIDE, 2 FLUTE SHORT LENGTH BALL NOSE

● VOLLHARTMETALL, 2 SCHNEIDEN KURZ STIRNRADIUS

○ Fraise carbure, 2 dents, hémisphérique, courte

○ 2 TAGLIANTI, SEMISFERICA, SERIE CORTA

- ▶ Suitable for dry milling applications at high temperatures.
- ▶ Excellent high-performance end mills.
- ▶ Designed for milling of radius bottom slots, fillets and special contours.

- ▶ Für die Trockenbearbeitung.
- ▶ Hervorragendes Preis - Leistungsverhältnis.
- ▶ Bestimmt für das Fräsen von Nuten mit konvexem Grund, Sonderprofilen und zum Kopieren.



Unit : mm

EDP No.	Radius of Ball Nose	Mill Diameter	Shank Diameter	Length of Cut	Overall Length
	R (±0.02)				
G9A70010	R0.5	1.0	3	3	39
G9A70015	R0.75	1.5	3	5	39
G9A70020	R1.0	2.0	3	7	39
G9A70025	R1.25	2.5	3	8	39
G9A70030	R1.5	3.0	3	9	39
G9A70040	R2.0	4.0	4	14	51
G9A70050	R2.5	5.0	5	16	51
G9A70060	R3.0	6.0	6	19	64
G9A70080	R4.0	8.0	8	21	64
G9A70100	R5.0	10.0	10	22	70
G9A70110	R5.5	11.0	11	25	70
G9A70120	R6.0	12.0	12	25	76
G9A70160	R8.0	16.0	16	32	89
G9A70200	R10.0	20.0	20	38	102

Mill Dia. Tolerance(mm)	Shank Dia. Tolerance
0 ~ - 0.03	h5

◎ : Excellent ○ : Good

ISO Material Description	P										M				K						
	Non-alloy steel					Low alloy steel					High alloyed steel, and tool steel				Stainless steel		Grey cast iron		Nodular cast iron		Malleable cast iron
VDI 3323	1	2	3	4	5	6	7	8	9	10	11	12	13	14	15	16	17	18	19	20	
HRc	13	25	28	32	10	29	32	38	35	15	35	15	23	10	10	26	3	25	42	55	
HB	125	190	250	270	300	180	275	300	350	200	325	200	240	180	180	260	160	250	130	230	
Recommend	◎	◎	◎	◎	◎	◎	◎	◎	◎	◎	◎	○	○	○	○	○	○	○	○	○	
ISO Material Description	N										S						H				
	Aluminum-wrought alloy		Aluminum-cast, alloyed			Copper and Copper Alloys (Bronze / Brass)			Non Metallic Materials		Heat Resistant Super Alloys						Titanium Alloys		Hardened steel	Chilled Cast Iron	Hardened Cast Iron
VDI 3323	21	22	23	24	25	26	27	28	29	30	31	32	33	34	35	36	37	38	39	40	41
HRc	60	100	75	90	130	110	90	100			200	280	250	350	320	400 Rm	1050 Rm	550	630	400	550
HB	60	100	75	90	130	110	90	100			200	280	250	350	320	400 Rm	1050 Rm	550	630	400	550
Recommend	○	○	○	○	○	○	○	○			○	○	○	○	○	○	○	○	○	○	○

CARBIDE, 2 FLUTE SHORT LENGTH BALL NOSE

- **VOLLHARTMETALL, 2 SCHNEIDEN KURZ STIRNRADIUS**
- **Fraise carbure, 2 dents, hémisphérique, courte**
- **2 TAGLIENTI, SEMISFERICA, SERIE CORTA**

- ▶ Suitable for dry milling applications at high temperatures.
- ▶ Excellent high-performance end mills.
- ▶ Designed for milling of radius bottom slots, fillets and special contours.

- ▶ Für die Trockenbearbeitung.
- ▶ Hervorragendes Preis - Leistungsverhältnis.
- ▶ Bestimmt für das Fräsen von Nuten mit konvexem Grund, Sonderprofilen und zum Kopieren.



CARBIDE
DIN 6527
2
≈ 30°
R ±0.02
DIN 6535HB
P.597

Unit : mm

EDP No.	Radius of Ball Nose	Mill Diameter	Shank Diameter	Length of Cut	Overall Length
	R (±0.02)				
G9437020	R1.0	2.0	6	3	50
G9437030	R1.5	3.0	6	4	50
G9437040	R2.0	4.0	6	5	54
G9437050	R2.5	5.0	6	6	54
G9437060	R3.0	6.0	6	7	54
G9437080	R4.0	8.0	8	9	58
G9437100	R5.0	10.0	10	11	66
G9437120	R6.0	12.0	12	12	73
G9437140	R7.0	14.0	14	14	75
G9437180	R9.0	18.0	18	18	84
G9437200	R10.0	20.0	20	20	92

Mill Dia. Tolerance(mm)	Shank Dia. Tolerance
0 ~ - 0.03	h5

◎ : Excellent ○ : Good

ISO Material Description	P											M			K					
	Non-alloy steel					Low alloy steel				High alloyed steel, and tool steel		Stainless steel			Grey cast iron		Nodular cast iron		Malleable cast iron	
VDI 3323	1	2	3	4	5	6	7	8	9	10	11	12	13	14	15	16	17	18	19	20
HRc	13	25	28	32	10	29	32	38	15	35	15	23	10	10	26	3	25		21	
HB	125	190	250	270	300	180	275	300	350	200	325	200	240	180	180	260	160	250	130	230
Recommend	◎	◎	◎	◎	◎	◎	◎	◎	◎	◎	◎	○	○	○	○	○	○	○	○	○

ISO Material Description	N										S						H				
	Aluminum-wrought alloy		Aluminum-cast, alloyed			Copper and Copper Alloys (Bronze / Brass)		Non Metallic Materials			Heat Resistant Super Alloys						Titanium Alloys		Hardened steel	Chilled Cast Iron	Hardened Cast Iron
VDI 3323	21	22	23	24	25	26	27	28	29	30	31	32	33	34	35	36	37	38	39	40	41
HRc											15	30	25	38	34			55	60	42	55
HB	60	100	75	90	130	110	90	100			200	280	250	350	320	400 Rm	1050 Rm	550	630	400	550
Recommend	○	○	○	○	○	○	○	○			○	○	○	○	○	○	○	○	○	○	○

CARBIDE, 2 FLUTE LONG LENGTH BALL NOSE

● VOLLHARTMETALL, 2 SCHNEIDEN LANG STIRNRADIUS

○ Fraise carbure, 2 dents, hémisphérique, longue

○ 2 TAGLIANTI, SEMISFERICA, SERIE LUNGA

- ▶ Suitable for dry milling applications at high temperatures.
- ▶ Excellent high-performance end mills.
- ▶ Designed for milling of radius bottom slots, fillets and special contours.

- ▶ Für die Trockenbearbeitung.
- ▶ Hervorragendes Preis - Leistungsverhältnis.
- ▶ Bestimmt für das Fräsen von Nuten mit konvexem Grund, Sonderprofilen und zum Kopieren.



Unit : mm

EDP No.	Radius of Ball Nose	Mill Diameter	Shank Diameter	Length of Cut	Overall Length
	R (±0.02)				
G9438020	R1.0	2.0	● 3	6	38
G9438030	R1.5	3.0	6	7	57
G9438040	R2.0	4.0	6	8	57
G9438050	R2.5	5.0	6	10	57
G9438060	R3.0	6.0	6	10	57
G9438080	R4.0	8.0	8	16	63
G9438100	R5.0	10.0	10	19	72
G9438120	R6.0	12.0	12	22	83
G9438140	R7.0	14.0	14	22	83
G9438160	R8.0	16.0	16	26	92
G9438180	R9.0	18.0	18	26	92
G9438200	R10.0	20.0	20	32	104

● with plain shank

Mill Dia. Tolerance(mm)	Shank Dia. Tolerance
0 ~ - 0.03	h5

◎ : Excellent ○ : Good

ISO Material Description	P										M				K						
	Non-alloy steel					Low alloy steel					High alloyed steel, and tool steel				Stainless steel		Grey cast iron		Nodular cast iron		Malleable cast iron
VDI 3323	1	2	3	4	5	6	7	8	9	10	11	12	13	14	15	16	17	18	19	20	
HRC	13	25	28	32	30	29	32	38	35	15	35	15	23	10	10	26	3	25	42	21	
HB	125	190	250	270	300	180	275	300	350	200	325	200	240	180	180	260	160	250	130	230	
Recommend	◎	◎	◎	◎	◎	◎	◎	◎	◎	◎	◎	○	○	○	○	○	○	○	○	○	

ISO Material Description	N					S										H					
	Aluminum-wrought alloy		Aluminum-cast, alloyed			Copper and Copper Alloys (Bronze / Brass)			Non Metallic Materials		Heat Resistant Super Alloys					Titanium Alloys		Hardened steel	Chilled Cast Iron	Hardened Cast Iron	
VDI 3323	21	22	23	24	25	26	27	28	29	30	31	32	33	34	35	36	37	38	39	40	41
HRC											15	30	25	38	34			55	60	42	55
HB	60	100	75	90	130	110	90	100			200	280	250	350	320	400 Rm	1050 Rm	550	630	400	550
Recommend	○	○	○	○	○	○	○	○			○	○	○	○	○	○	○	○	○	○	○

CARBIDE, 2 FLUTE LONG REACH BALL NOSE

- **VOLLHARTMETALL, 2 SCHNEIDEN GROÖE REICHWEITE STIRNRADIUS**
- **Fraise carbure, 2 dents, hémisphérique longue portée**
- **2 TAGLIENTI, SEMISFERICA, GAMBO LUNGO**

- ▶ Suitable for dry milling applications at high temperatures.
- ▶ Excellent high-performance end mills.
- ▶ Designed for milling of radius bottom slots, fillets and special contours.

- ▶ Für die Trockenbearbeitung.
- ▶ Hervorragendes Preis - Leistungsverhältnis.
- ▶ Bestimmt für das Fräsen von Nuten mit konvexem Grund, Sonderprofilen und zum Kopieren.



CARBIDE
2
30°
R ±0.02
DIN 6535HA
P.597

Unit : mm

EDP No.	Radius of Ball Nose	Mill Diameter	Shank Diameter	Length of Cut	Overall Length
	R (±0.02)				
G9454030	R1.5	3.0	3	5	75
G9454040	R2.0	4.0	4	8	75
G9454050	R2.5	5.0	5	9	75
G9454060	R3.0	6.0	6	10	100
G9454080	R4.0	8.0	8	12	100
G9454100	R5.0	10.0	10	14	100
G9454120	R6.0	12.0	12	16	100
G9454140	R7.0	14.0	14	18	100
G9454160	R8.0	16.0	16	22	150
G9454200	R10.0	20.0	20	26	150

Mill Dia. Tolerance(mm)	Shank Dia. Tolerance
0 ~ - 0.03	h5

◎ : Excellent ○ : Good

ISO Material Description	P											M			K					
	Non-alloy steel					Low alloy steel				High alloyed steel, and tool steel		Stainless steel			Grey cast iron		Nodular cast iron		Malleable cast iron	
VDI 3323	1	2	3	4	5	6	7	8	9	10	11	12	13	14	15	16	17	18	19	20
HRc	13	25	28	32	30	29	32	38	15	35	15	23	10	10	26	3	25		21	
HB	125	190	250	270	300	180	275	300	350	200	325	200	240	180	180	260	160	250	130	230
Recommend	◎	◎	◎	◎	◎	◎	◎	◎	◎	◎	◎	○	○	○	○	○	○	○	○	○

ISO Material Description	N										S						H				
	Aluminum-wrought alloy		Aluminum-cast, alloyed			Copper and Copper Alloys (Bronze / Brass)		Non Metallic Materials			Heat Resistant Super Alloys						Titanium Alloys		Hardened steel	Chilled Cast Iron	Hardened Cast Iron
VDI 3323	21	22	23	24	25	26	27	28	29	30	31	32	33	34	35	36	37	38	39	40	41
HRc											15	30	25	38	34			55	60	42	55
HB	60	100	75	90	130	110	90	100			200	280	250	350	320	400 Rm	1050 Rm	550	630	400	550
Recommend	○	○	○	○	○	○	○	○			○	○	○	○	○	○	○	○	○	○	○

CARBIDE, 2 FLUTE EXTRA LONG LENGTH BALL NOSE

● VOLLHARTMETALL, 2 SCHNEIDEN EXTRA LANG STIRNRADIUS

○ Fraise carbure, 2 dents, hémisphérique, extra-longue

○ 2 TAGLIANTI, SEMISFERICA, SERIE EXTRA LUNGA

- ▶ Suitable for dry milling applications at high temperatures.
- ▶ Excellent high-performance end mills.
- ▶ Designed for milling of radius bottom slots, fillets and special contours.

- ▶ Für die Trockenbearbeitung.
- ▶ Hervorragendes Preis - Leistungsverhältnis.
- ▶ Bestimmt für das Fräsen von Nuten mit konvexem Grund, Sonderprofilen und zum Kopieren.



Unit : mm

EDP No.	Radius of Ball Nose	Mill Diameter	Shank Diameter	Length of Cut	Overall Length
	R (±0.02)				
G9455903	R1.5	3.0	3	20	60
G9455030	R1.5	3.0	3	30	75
G9455904	R2.0	4.0	4	20	60
G9455040	R2.0	4.0	4	30	75
G9455905	R2.5	5.0	5	25	75
G9455050	R2.5	5.0	5	40	100
G9455906	R3.0	6.0	6	30	75
G9455060	R3.0	6.0	6	50	150
G9455908	R4.0	8.0	8	30	75
G9455080	R4.0	8.0	8	50	150
G9455910	R5.0	10.0	10	40	100
G9455100	R5.0	10.0	10	60	150
G9455912	R6.0	12.0	12	45	100
G9455914	R7.0	14.0	14	45	100
G9455916	R8.0	16.0	16	45	100
G9455918	R9.0	18.0	18	45	100
G9455920	R10.0	20.0	20	45	100
G9438200	R10.0	20.0	20	32	104

Mill Dia. Tolerance(mm)	Shank Dia. Tolerance
0 ~ - 0.03	h5

◎ : Excellent ○ : Good

ISO Material Description	P										M				K						
	Non-alloy steel					Low alloy steel					High alloyed steel, and tool steel				Stainless steel		Grey cast iron		Nodular cast iron		Malleable cast iron
VDI 3323	1	2	3	4	5	6	7	8	9	10	11	12	13	14	15	16	17	18	19	20	
HRC	13	25	28	32	10	29	32	38	15	35	15	23	10	10	26	3	25	3	25		
HB	125	190	250	270	300	180	275	300	350	200	325	200	240	180	180	260	160	250	130	230	
Recommend	◎	◎	◎	◎	◎	◎	◎	◎	◎	◎	◎	◎	○	○	○	○	○	○	○	○	

ISO Material Description	N										S						H				
	Aluminum-wrought alloy		Aluminum-cast, alloyed			Copper and Copper Alloys (Bronze / Brass)			Non Metallic Materials		Heat Resistant Super Alloys						Titanium Alloys		Hardened steel	Chilled Cast Iron	Hardened Cast Iron
VDI 3323	21	22	23	24	25	26	27	28	29	30	31	32	33	34	35	36	37	38	39	40	41
HRC	60	100	75	90	130	110	90	100			200	280	250	350	320	400 Rm	1050 Rm	550	630	400	550
Recommend	○	○	○	○	○	○	○	○			○	○	○	○	○	○	○	○	○	○	○

CARBIDE, 2 FLUTE BALL NOSE for RIB PROCESSING

- **VOLLHARTMETALL, 2 SCHNEIDEN STIRNRADIUS für SCHMALE RIPPEN**
- **Fraise carbure, 2 dents, hémisphérique pour usinage de rainure**
- **2 TAGLIENTI, SEMISFERICA, SCARICATA PER NERVATURE**

- ▶ Suitable for dry milling applications at high temperatures.
- ▶ Excellent high-performance end mills.
- ▶ Designed for milling of radius bottom slots, fillets and special contours.

- ▶ Für die Trockenbearbeitung.
- ▶ Hervorragendes Preis - Leistungsverhältnis.
- ▶ Bestimmt für das Fräsen von Nuten mit konvexem Grund, Sonderprofilen und zum Kopieren.

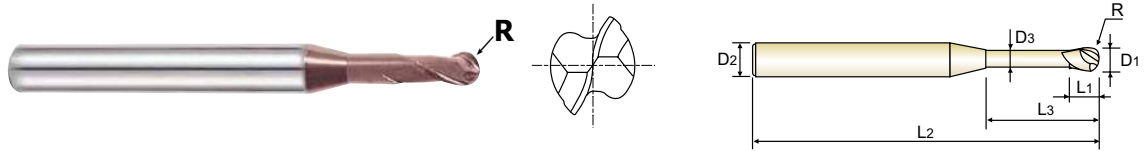

Unit : mm

EDP No.	Radius of Ball Nose	Mill Diameter	Shank Diameter	Length of Cut	Length Below Shank	Overall Length	Neck Diameter
	R (±0.02)	D1	D2	L1	L3	D3	D3
G9B81004	R0.2	0.4	4	0.7	2	50	0.37
G9B81005	R0.25	0.5	4	0.75	2	50	0.45
G9B81901	R0.25	0.5	4	0.75	4	50	0.45
G9B81902	R0.25	0.5	4	0.75	6	50	0.45
G9B81006	R0.3	0.6	4	0.9	2	50	0.55
G9B81903	R0.3	0.6	4	0.9	4	50	0.55
G9B81904	R0.3	0.6	4	0.9	6	50	0.55
G9B81008	R0.4	0.8	4	1.2	4	50	0.75
G9B81905	R0.4	0.8	4	1.2	6	50	0.75
G9B81906	R0.4	0.8	4	1.2	8	50	0.75
G9B81010	R0.5	1.0	4	1.5	6	50	0.95
G9B81907	R0.5	1.0	4	1.5	8	50	0.95
G9B81908	R0.5	1.0	4	1.5	10	50	0.95
G9B81909	R0.5	1.0	4	1.5	12	50	0.95
G9B81012	R0.6	1.2	4	1.8	8	50	1.15
G9B81910	R0.6	1.2	4	1.8	12	50	1.15
G9B81014	R0.7	1.4	4	2.1	16	50	1.35
G9B81015	R0.75	1.5	4	2.3	6	50	1.45
G9B81911	R0.75	1.5	4	2.3	8	50	1.45
G9B81912	R0.75	1.5	4	2.3	10	50	1.45
G9B81913	R0.75	1.5	4	2.3	12	50	1.45
G9B81914	R0.75	1.5	4	2.3	16	50	1.45
G9B81915	R0.75	1.5	4	2.3	20	50	1.45
G9B81016	R0.8	1.6	4	2.4	8	50	1.55

▶ NEXT PAGE

Mill Dia. Tolerance(mm)	Shank Dia. Tolerance
0 ~ - 0.03	h5

◎ : Excellent ○ : Good

ISO Material Description	P											M				K					
	Non-alloy steel					Low alloy steel				High alloyed steel, and tool steel		Stainless steel				Grey cast iron		Nodular cast iron		Malleable cast iron	
VDI 3323	1	2	3	4	5	6	7	8	9	10	11	12	13	14	15	16	17	18	19	20	
HRc		13	25	28	32	10	29	32	38	15	35	15	23	10	10	26	3	25		21	
HB	125	190	250	270	300	180	275	300	350	200	325	200	240	180	180	260	160	250	130	230	
Recommend	◎	◎	◎	◎	◎	◎	◎	◎	◎	◎	◎	○	○	○	○	○	○	○	○	○	
ISO Material Description	N									S							H				
	Aluminum-wrought alloy		Aluminum-cast, alloyed			Copper and Copper Alloys (Bronze / Brass)				Non Metallic Materials		Heat Resistant Super Alloys					Titanium Alloys		Hardened steel	Chilled Cast Iron	Hardened Cast Iron
VDI 3323	21	22	23	24	25	26	27	28	29	30	31	32	33	34	35	36	37	38	39	40	41
HRc											15	30	25	38	34			55	60	42	55
HB	60	100	75	90	130	110	90	100			200	280	250	350	320	400 Rm	1050 Rm	550	630	400	550
Recommend	○	○	○	○	○	○	○	○													

CARBIDE, 2 FLUTE BALL NOSE for RIB PROCESSING

- VOLLHARTMETALL, 2 SCHNEIDEN STIRNRADIUS für SCHMALE RIPPEN
- Ⓢ Fraise carbure, 2 dents, hémisphérique pour usinage de rainure
- Ⓢ 2 TAGLIANTI, SEMISFERICA, SCARICATA PER NERVATURE

- ▶ Suitable for dry milling applications at high temperatures.
- ▶ Für die Trockenbearbeitung.
- ▶ Excellent high-performance end mills.
- ▶ Hervorragendes Preis - Leistungsverhältnis.
- ▶ Designed for milling of radius bottom slots, fillets and special contours.
- ▶ Bestimmt für das Fräsen von Nuten mit konvexem Grund, Sonderprofilen und zum Kopieren.

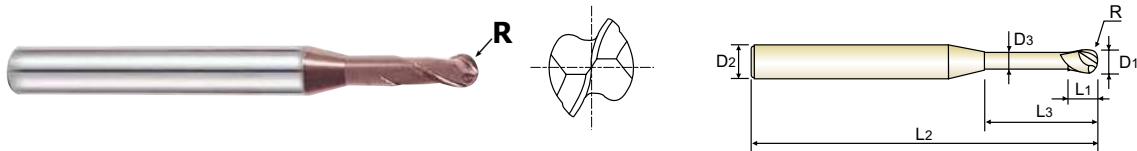

Unit : mm

EDP No.	Radius of Ball Nose	Mill Diameter	Shank Diameter	Length of Cut	Length Below Shank	Overall Length	Neck Diameter
	R (±0.02)	D1	D2	L1	L3	D3	D3
G9B81916	R0.8	1.6	4	2.4	12	50	1.55
G9B81917	R0.8	1.6	4	2.4	16	50	1.55
G9B81918	R0.8	1.6	4	2.4	20	50	1.55
G9B81020	R1.0	2.0	4	3	8	50	1.95
G9B81919	R1.0	2.0	4	3	10	50	1.95
G9B81920	R1.0	2.0	4	3	12	50	1.95
G9B81921	R1.0	2.0	4	3	14	50	1.95
G9B81922	R1.0	2.0	4	3	16	50	1.95
G9B81923	R1.0	2.0	4	3	20	50	1.95
G9B81030	R1.5	3.0	6	4.5	10	50	2.85
G9B81924	R1.5	3.0	6	4.5	12	50	2.85
G9B81925	R1.5	3.0	6	4.5	16	60	2.85
G9B81926	R1.5	3.0	6	4.5	20	60	2.85
G9B81927	R1.5	3.0	6	4.5	25	75	2.85
G9B81040	R2.0	4.0	6	6	12	50	3.85
G9B81928	R2.0	4.0	6	6	16	60	3.85
G9B81929	R2.0	4.0	6	6	20	75	3.85
G9B81930	R2.0	4.0	6	6	25	75	3.85
G9B81931	R2.0	4.0	6	6	30	75	3.85

Mill Dia. Tolerance(mm)	Shank Dia. Tolerance
0 ~ - 0.03	h5

◎ : Excellent ○ : Good

ISO Material Description	P										M				K						
	Non-alloy steel					Low alloy steel					High alloyed steel, and tool steel				Stainless steel		Grey cast iron		Nodular cast iron		Malleable cast iron
VDI 3323	1	2	3	4	5	6	7	8	9	10	11	12	13	14	15	16	17	18	19	20	
HRC	13	25	28	32	10	29	32	38	15	35	15	23	10	10	26	3	25	130	21		
HB	125	190	250	270	300	180	275	300	350	200	325	200	240	180	180	260	160	250	130	230	
Recommend	◎	◎	◎	◎	◎	◎	◎	◎	◎	◎	◎	○	○	○	○	○	○	○	○	○	

ISO Material Description	N					S										H					
	Aluminum-wrought alloy		Aluminum-cast, alloyed			Copper and Copper Alloys (Bronze / Brass)			Non Metallic Materials		Heat Resistant Super Alloys					Titanium Alloys		Hardened steel	Chilled Cast Iron	Hardened Cast Iron	
VDI 3323	21	22	23	24	25	26	27	28	29	30	31	32	33	34	35	36	37	38	39	40	41
HRC	60	100	75	90	130	110	90	100			15	30	25	38	34	400 Rm	1050 Rm	55	60	42	55
HB	60	100	75	90	130	110	90	100			200	280	250	350	320	400 Rm	1050 Rm	550	630	400	550
Recommend	○	○	○	○	○	○	○	○													

CARBIDE, 4 FLUTE SHORT LENGTH BALL NOSE

- **VOLLHARTMETALL, 4 SCHNEIDEN KURZ STIRNRADIUS**
- **Fraise carbure, 4 dents, hémisphérique, courte**
- **4 TAGLIENTI, SEMISFERICA, SERIE CORTA**

- ▶ Suitable for dry milling applications at high temperatures.
- ▶ Excellent high-performance end mills.
- ▶ 4 flute allows for better work piece finishes.
- ▶ Designed for milling of radius bottom slots, fillets and special contours.

- ▶ Für die Trockenbearbeitung.
- ▶ Hervorragendes Preis - Leistungsverhältnis.
- ▶ 4 Schneiden erzeugen eine bessere Oberflächengüte des Werkstücks.
- ▶ Bestimmt für das Fräsen von Nuten mit konvexem Grund, Sonderprofilen und zum Kopieren.



CARBIDE 4 30° R ±0.02 DIN 6535HA P.600

Unit : mm

EDP No.	Radius of Ball Nose	Mill Diameter	Shank Diameter	Length of Cut	Overall Length
	R (±0.02)				
G9634020	R1.0	2.0	6	4	48
G9634030	R1.5	3.0	6	4	48
G9634040	R2.0	4.0	6	6	50
G9634050	R2.5	5.0	6	7	51
G9634060	R3.0	6.0	6	7	51
G9634080	R4.0	8.0	8	9	59
G9634100	R5.0	10.0	10	10	60
G9634120	R6.0	12.0	12	14	71
G9634140	R7.0	14.0	14	14	71
G9634160	R8.0	16.0	16	16	76
G9634180	R9.0	18.0	18	18	76
G9634200	R10.0	20.0	20	20	82

Mill Dia. Tolerance(mm)	Shank Dia. Tolerance
0 ~ - 0.03	h5

K-2
END MILLS

ONLY ONE
COATED PM60
END MILLS

TANK-
POWER
END MILLS

GENERAL
HSS
END MILLS

MILLING
CUTTERS

TECHNICAL
DATA

◎ : Excellent ○ : Good

ISO Material Description	P											M			K						
	Non-alloy steel					Low alloy steel						High alloyed steel, and tool steel			Stainless steel			Grey cast iron		Nodular cast iron	
VDI 3323	1	2	3	4	5	6	7	8	9	10	11	12	13	14	15	16	17	18	19	20	
HRc	13	25	28	32	10	29	32	38	15	35	15	23	10	10	26	3	25		21		
HB	125	190	250	270	300	180	275	300	350	200	325	200	240	180	180	260	160	250	130	230	
Recommend	◎	◎	◎	◎	◎	◎	◎	◎	◎	◎	◎	○	○	○	○	○	○	○	○	○	
ISO Material Description	N										S					H					
	Aluminum-wrought alloy		Aluminum-cast, alloyed			Copper and Copper Alloys (Bronze / Brass)			Non Metallic Materials		Heat Resistant Super Alloys					Titanium Alloys		Hardened steel	Chilled Cast Iron		Hardened Cast Iron
VDI 3323	21	22	23	24	25	26	27	28	29	30	31	32	33	34	35	36	37	38	39	40	41
HRc											15	30	25	38	34			55	60	42	55
HB	60	100	75	90	130	110	90	100			200	280	250	350	320	400 Rm	1050 Rm	550	630	400	550
Recommend	○	○	○	○	○	○	○	○			○	○	○	○	○	○	○	○	○	○	○

CARBIDE, 2 FLUTE SHORT LENGTH CORNER RADIUS

● VOLLHARTMETALL, 2 SCHNEIDEN KURZ ECKENRADIUS

● Fraise carbure, 2 dents, torique, courte

● 2 TAGLIANTI, SERIE CORTA, TORICA

- ▶ Suitable for dry milling applications at high temperatures.
- ▶ Excellent high-performance end mills.
- ▶ 2 flute design for slotting.

- ▶ Für die Trockenbearbeitung.
- ▶ Hervorragendes Preis - Leistungsverhältnis.
- ▶ 2 Schneiden zum Nutenfräsen.



Unit : mm

EDP No.	Corner Radius	Mill Diameter	Shank Diameter	Length of Cut	Overall Length
	R				
G9B82020	R0.2	2.0	4	4	50
G9B82901	R0.3	2.0	4	4	50
G9B82902	R0.5	2.0	4	4	50
G9B82025	R0.2	2.5	4	5	50
G9B82903	R0.3	2.5	4	5	50
G9B82904	R0.5	2.5	4	5	50
G9B82030	R0.2	3.0	4	6	50
G9B82905	R0.3	3.0	4	6	50
G9B82906	R0.5	3.0	4	6	50
G9B82907	R1.0	3.0	4	6	50
G9B82040	R0.2	4.0	4	8	50
G9B82908	R0.3	4.0	4	8	50
G9B82909	R0.5	4.0	4	8	50
G9B82910	R1.0	4.0	4	8	50
G9B82050	R0.2	5.0	6	10	50
G9B82911	R0.3	5.0	6	10	50
G9B82912	R0.5	5.0	6	10	50
G9B82913	R1.0	5.0	6	10	50
G9B82060	R0.2	6.0	6	12	50
G9B82914	R0.3	6.0	6	12	50
G9B82915	R0.5	6.0	6	12	50
G9B82916	R1.0	6.0	6	12	50

▶ NEXT PAGE

Mill Dia. Tolerance(mm)	Shank Dia. Tolerance
0 ~ - 0.03	h5

◎ : Excellent ○ : Good

ISO Material Description	P										M				K					
	Non-alloy steel					Low alloy steel					High alloyed steel, and tool steel		Stainless steel		Grey cast iron		Nodular cast iron		Malleable cast iron	
VDI 3323	1	2	3	4	5	6	7	8	9	10	11	12	13	14	15	16	17	18	19	20
HRC		13	25	28	32	10	29	32	38	15	35	15	23	10	10	26	3	25	42	21
HB	125	190	250	270	300	180	275	300	350	200	325	200	240	180	180	260	160	250	130	230
Recommend	◎	◎	◎	◎	◎	◎	◎	◎	◎	◎	◎	○	○	○	○	○	○	○	○	○

ISO Material Description	N					S										H					
	Aluminum-wrought alloy		Aluminum-cast, alloyed		Copper and Copper Alloys (Bronze / Brass)	Non Metallic Materials	Heat Resistant Super Alloys					Titanium Alloys		Hardened steel	Chilled Cast Iron	Hardened Cast Iron					
VDI 3323	21	22	23	24	25	26	27	28	29	30	31	32	33	34	35	36	37	38	39	40	41
HRC											15	30	25	38	34			55	60	42	55
HB	60	100	75	90	130	110	90	100			200	280	250	350	320	400 Rm	1050 Rm	550	630	400	550
Recommend	○	○	○	○	○	○	○	○	○	○	○	○	○	○	○	○	○	○	○	○	○

CARBIDE, 2 FLUTE SHORT LENGTH CORNER RADIUS

- **VOLLHARTMETALL, 2 SCHNEIDEN KURZ ECKENRADIUS**
- **Fraise carbure, 2 dents, torique, courte**
- **2 TAGLIENTI, SERIE CORTA, TORICA**

- ▶ Suitable for dry milling applications at high temperatures.
- ▶ Excellent high-performance end mills.
- ▶ 2 flute design for slotting.

- ▶ Für die Trockenbearbeitung.
- ▶ Hervorragendes Preis - Leistungsverhältnis.
- ▶ 2 Schneiden zum Nutenfräsen.



CARBIDE 2 30° DIN 6535HA P.601

Unit : mm

EDP No.	Corner Radius	Mill Diameter	Shank Diameter	Length of Cut	Overall Length
	R				
G9B82080	R0.5	8.0	8	16	60
G9B82917	R1.0	8.0	8	16	60
G9B82918	R1.5	8.0	8	16	60
G9B82919	R2.0	8.0	8	16	60
G9B82920	R2.5	8.0	8	16	60
G9B82100	R0.5	10.0	10	20	75
G9B82921	R1.0	10.0	10	20	75
G9B82922	R1.5	10.0	10	20	75
G9B82923	R2.0	10.0	10	20	75
G9B82924	R2.5	10.0	10	20	75
G9B82120	R0.5	12.0	12	24	75
G9B82925	R1.0	12.0	12	24	75
G9B82926	R1.5	12.0	12	24	75
G9B82927	R2.0	12.0	12	24	75
G9B82928	R2.5	12.0	12	24	75

Mill Dia. Tolerance(mm)	Shank Dia. Tolerance
0 ~ - 0.03	h5

◎ : Excellent ○ : Good

ISO Material Description	P											M			K						
	Non-alloy steel					Low alloy steel				High alloyed steel, and tool steel		Stainless steel			Grey cast iron		Nodular cast iron		Malleable cast iron		
VDI 3323	1	2	3	4	5	6	7	8	9	10	11	12	13	14	15	16	17	18	19	20	
HRc	13	25	28	32	10	29	32	38	15	35	15	23	10	10	26	3	25		21		
HB	125	190	250	270	300	180	275	300	350	200	325	200	240	180	180	260	160	250	130	230	
Recommend	◎	◎	◎	◎	◎	◎	◎	◎	◎	◎	◎	○	○	○	○	○	○	○	○	○	
ISO Material Description	N										S						H				
	Aluminum-wrought alloy		Aluminum-cast, alloyed			Copper and Copper Alloys (Bronze / Brass)			Non Metallic Materials		Heat Resistant Super Alloys						Titanium Alloys		Hardened steel	Chilled Cast Iron	Hardened Cast Iron
VDI 3323	21	22	23	24	25	26	27	28	29	30	31	32	33	34	35	36	37	38	39	40	41
HRc											15	30	25	38	34			55	60	42	55
HB	60	100	75	90	130	110	90	100			200	280	250	350	320	400 Rm	1050 Rm	550	630	400	550
Recommend	○	○	○	○	○	○	○	○	○	○											

CARBIDE, 2 FLUTE LONG REACH CORNER RADIUS

- VOLLHARTMETALL, 2 SCHNEIDEN GROÙE REICHWEITE ECKENRADIUS
- Fraise carbure, 2 dents, torique longue portée
- 2 TAGLIANTI, SERIE LUNGA, TORICA

- ▶ Suitable for dry milling applications at high temperatures.
- ▶ Excellent high-performance end mills.
- ▶ 2 flute design for slotting.

- ▶ Für die Trockenbearbeitung.
- ▶ Hervorragendes Preis - Leistungsverhältnis.
- ▶ 2 Schneiden zum Nutenfräsen.



Unit : mm

EDP No.	Corner Radius	Mill Diameter	Shank Diameter	Length of Cut	Overall Length
	R				
G9B83030	R0.5	3.0	4	6	75
G9B83901	R1.0	3.0	4	6	75
G9B83040	R0.5	4.0	4	8	75
G9B83902	R1.0	4.0	4	8	75
G9B83050	R0.5	5.0	6	10	75
G9B83903	R1.0	5.0	6	10	75
G9B83060	R0.5	6.0	6	12	75
G9B83904	R1.0	6.0	6	12	75
G9B83080	R0.5	8.0	8	16	100
G9B83905	R1.0	8.0	8	16	100
G9B83906	R1.5	8.0	8	16	100
G9B83907	R2.0	8.0	8	16	100
G9B83908	R2.5	8.0	8	16	100
G9B83100	R0.5	10.0	10	20	100
G9B83909	R1.0	10.0	10	20	100
G9B83910	R1.5	10.0	10	20	100
G9B83911	R2.0	10.0	10	20	100
G9B83912	R2.5	10.0	10	20	100
G9B83120	R0.5	12.0	12	24	100
G9B83913	R1.0	12.0	12	24	100
G9B83914	R1.5	12.0	12	24	100
G9B83915	R2.0	12.0	12	24	100
G9B83916	R2.5	12.0	12	24	100

Mill Dia. Tolerance(mm)	Shank Dia. Tolerance
0 ~ - 0.03	h5

◎ : Excellent ○ : Good

ISO Material Description	P										M				K					
	Non-alloy steel					Low alloy steel					High alloyed steel, and tool steel		Stainless steel		Grey cast iron		Nodular cast iron		Malleable cast iron	
VDI 3323	1	2	3	4	5	6	7	8	9	10	11	12	13	14	15	16	17	18	19	20
HRC		13	25	28	32	10	29	32	38	15	35	15	23	10	10	26	3	25		21
HB	125	190	250	270	300	180	275	300	350	200	325	200	240	180	180	260	160	250	130	230
Recommend	◎	◎	◎	◎	◎	◎	◎	◎	◎	◎	◎	○	○	○	○	○	○	○	○	○

ISO Material Description	N										S						H				
	Aluminum-wrought alloy		Aluminum-cast, alloyed			Copper and Copper Alloys (Bronze / Brass)			Non Metallic Materials		Heat Resistant Super Alloys				Titanium Alloys		Hardened steel	Chilled Cast Iron	Hardened Cast Iron		
VDI 3323	21	22	23	24	25	26	27	28	29	30	31	32	33	34	35	36	37	38	39	40	41
HRC											15	30	25	38	34			55	60	42	55
HB	60	100	75	90	130	110	90	100			200	280	250	350	320	400 Rm	1050 Rm	550	630	400	550
Recommend	○	○	○	○	○	○	○	○	○	○	○	○	○	○	○	○	○	○	○	○	○

CARBIDE, 4 FLUTE SHORT LENGTH CORNER RADIUS

- **VOLLHARTMETALL, 4 SCHNEIDEN KURZ ECKENRADIUS**
- **Fraise carbure, 4 dents, torique, courte**
- **4 TAGLIENTI, SERIE CORTA, TORICA**

- ▶ Suitable for dry milling applications at high temperatures.
- ▶ Excellent high-performance end mills.
- ▶ Designed for milling of radius bottom slots, fillets and special contours.

- ▶ Für die Trockenbearbeitung.
- ▶ Hervorragendes Preis - Leistungsverhältnis.
- ▶ Bestimmt für das Fräsen von Nuten mit konvexem Grund, Sonderprofilen und zum Kopieren.



CARBIDE 4 30° DIN 6535HA P.602

Unit : mm

EDP No.	Corner Radius	Mill Diameter	Shank Diameter	Length of Cut	Overall Length
	R				
G9B84020	R0.2	2.0	4	4	50
G9B84901	R0.3	2.0	4	4	50
G9B84902	R0.5	2.0	4	4	50
G9B84025	R0.2	2.5	4	5	50
G9B84903	R0.3	2.5	4	5	50
G9B84904	R0.5	2.5	4	5	50
G9B84030	R0.2	3.0	4	6	50
G9B84905	R0.3	3.0	4	6	50
G9B84906	R0.5	3.0	4	6	50
G9B84907	R1.0	3.0	4	6	50
G9B84040	R0.2	4.0	4	8	50
G9B84908	R0.3	4.0	4	8	50
G9B84909	R0.5	4.0	4	8	50
G9B84910	R1.0	4.0	4	8	50
G9B84050	R0.2	5.0	6	10	50
G9B84911	R0.3	5.0	6	10	50
G9B84912	R0.5	5.0	6	10	50
G9B84913	R1.0	5.0	6	10	50
G9B84060	R0.2	6.0	6	12	50
G9B84914	R0.3	6.0	6	12	50
G9B84915	R0.5	6.0	6	12	50
G9B84916	R1.0	6.0	6	12	50
G9B84080	R0.5	8.0	8	16	60
G9B84917	R1.0	8.0	8	16	60

▶ NEXT PAGE

Mill Dia. Tolerance(mm)	Shank Dia. Tolerance
0 ~ - 0.03	h5

◎ : Excellent ○ : Good

ISO Material Description	P											M			K						
	Non-alloy steel					Low alloy steel				High alloyed steel, and tool steel		Stainless steel			Grey cast iron		Nodular cast iron		Malleable cast iron		
VDI 3323	1	2	3	4	5	6	7	8	9	10	11	12	13	14	15	16	17	18	19	20	
HRc		13	25	28	32	10	29	32	38	15	35	15	23	10	10	26	3	25		21	
HB	125	190	250	270	300	180	275	300	350	200	325	200	240	180	180	260	160	250	130	230	
Recommend	◎	◎	◎	◎	◎	◎	◎	◎	◎	◎	◎	○	○	○	○	○	○	○	○	○	
ISO Material Description	N										S							H			
	Aluminum-wrought alloy		Aluminum-cast, alloyed			Copper and Copper Alloys (Bronze / Brass)			Non Metallic Materials		Heat Resistant Super Alloys					Titanium Alloys		Hardened steel	Chilled Cast Iron	Hardened Cast Iron	
VDI 3323	21	22	23	24	25	26	27	28	29	30	31	32	33	34	35	36	37	38	39	40	41
HRc											15	30	25	38	34			55	60	42	55
HB	60	100	75	90	130	110	90	100			200	280	250	350	320	400 Rm	1050 Rm	550	630	400	550
Recommend	○	○	○	○	○	○	○	○	○	○	○	○	○	○	○	○	○	○	○	○	○

CARBIDE, 4 FLUTE SHORT LENGTH CORNER RADIUS

- **VOLLHARTMETALL, 4 SCHNEIDEN KURZ ECKENRADIUS**
- **Fraise carbure, 4 dents, torique, courte**
- **4 TAGLIANTI, SERIE CORTA, TORICA**

- ▶ Suitable for dry milling applications at high temperatures.
- ▶ Excellent high-performance end mills.
- ▶ Designed for milling of radius bottom slots, fillets and special contours.

- ▶ Für die Trockenbearbeitung.
- ▶ Hervorragendes Preis - Leistungsverhältnis.
- ▶ Bestimmt für das Fräsen von Nuten mit konvexem Grund, Sonderprofilen und zum Kopieren.



Unit : mm

EDP No.	Corner Radius	Mill Diameter	Shank Diameter	Length of Cut	Overall Length
	R				
G9B84918	R1.5	8.0	8	16	60
G9B84919	R2.0	8.0	8	16	60
G9B84920	R2.5	8.0	8	16	60
G9B84100	R0.5	10.0	10	20	75
G9B84921	R1.0	10.0	10	20	75
G9B84922	R1.5	10.0	10	20	75
G9B84923	R2.0	10.0	10	20	75
G9B84924	R2.5	10.0	10	20	75
G9B84120	R0.5	12.0	12	24	75
G9B84925	R1.0	12.0	12	24	75
G9B84926	R1.5	12.0	12	24	75
G9B84927	R2.0	12.0	12	24	75
G9B84928	R2.5	12.0	12	24	75

Mill Dia. Tolerance(mm)	Shank Dia. Tolerance
0 ~ - 0.03	h5

◎ : Excellent ○ : Good

ISO Material Description	P											M				K								
	Non-alloy steel					Low alloy steel						High alloyed steel, and tool steel				Stainless steel				Grey cast iron		Nodular cast iron		Malleable cast iron
VDI 3323	1	2	3	4	5	6	7	8	9	10	11	12	13	14	15	16	17	18	19	20				
HRc	13	25	28	32	10	29	32	38	35	15	35	23	10	10	26	3	25	3	25					
HB	125	190	250	270	300	180	275	300	350	200	325	200	240	180	180	260	160	250	130	230				
Recommend	◎	◎	◎	◎	◎	◎	◎	◎	◎	◎	◎	○	○	○	○	○	○	○	○	○				

ISO Material Description	N										S						H				
	Aluminum-wrought alloy		Aluminum-cast, alloyed			Copper and Copper Alloys (Bronze / Brass)			Non Metallic Materials		Heat Resistant Super Alloys						Titanium Alloys		Hardened steel	Chilled Cast Iron	Hardened Cast Iron
VDI 3323	21	22	23	24	25	26	27	28	29	30	31	32	33	34	35	36	37	38	39	40	41
HRc	60	100	75	90	130	110	90	100			15	30	25	38	34	400 Rm	1050 Rm	550	630	400	550
Recommend	○	○	○	○	○	○	○	○	○	○	○	○	○	○	○	○	○	○	○	○	○

CARBIDE, 4 FLUTE LONG REACH CORNER RADIUS

- **VOLLHARTMETALL, 4 SCHNEIDEN GROÖE REICHWEITE ECKENRADIUS**
- **Fraise carbure, 4 dents, torique longue portée**
- **4 TAGLIENTI, SERIE LUNGA, TORICA**

- ▶ Suitable for dry milling applications at high temperatures.
- ▶ Excellent high-performance end mills.
- ▶ Designed for milling of radius bottom slots, fillets and special contours.

- ▶ Für die Trockenbearbeitung.
- ▶ Hervorragendes Preis - Leistungsverhältnis.
- ▶ Bestimmt für das Fräsen von Nuten mit konvexem Grund, Sonderprofilen und zum Kopieren.



Unit : mm

EDP No.	Corner Radius	Mill Diameter	Shank Diameter	Length of Cut	Overall Length
	R				
G9B85030	R0.5	3.0	4	6	75
G9B85901	R1.0	3.0	4	6	75
G9B85040	R0.5	4.0	4	8	75
G9B85902	R1.0	4.0	4	8	75
G9B85050	R0.5	5.0	6	10	75
G9B85903	R1.0	5.0	6	10	75
G9B85060	R0.5	6.0	6	12	75
G9B85904	R1.0	6.0	6	12	75
G9B85080	R0.5	8.0	8	16	100
G9B85905	R1.0	8.0	8	16	100
G9B85906	R1.5	8.0	8	16	100
G9B85907	R2.0	8.0	8	16	100
G9B85908	R2.5	8.0	8	16	100
G9B85100	R0.5	10.0	10	20	100
G9B85909	R1.0	10.0	10	20	100
G9B85910	R1.5	10.0	10	20	100
G9B85911	R2.0	10.0	10	20	100
G9B85912	R2.5	10.0	10	20	100
G9B85120	R0.5	12.0	12	24	100
G9B85913	R1.0	12.0	12	24	100
G9B85914	R1.5	12.0	12	24	100
G9B85915	R2.0	12.0	12	24	100
G9B85916	R2.5	12.0	12	24	100

Mill Dia. Tolerance(mm)	Shank Dia. Tolerance
0 ~ -0.03	h5

◎ : Excellent ○ : Good

ISO Material Description	P											M			K						
	Non-alloy steel					Low alloy steel				High alloyed steel, and tool steel		Stainless steel			Grey cast iron		Nodular cast iron		Malleable cast iron		
VDI 3323	1	2	3	4	5	6	7	8	9	10	11	12	13	14	15	16	17	18	19	20	
HRc		13	25	28	32	10	29	32	38	15	35	15	23	10	10	26	3	25		21	
HB	125	190	250	270	300	180	275	300	350	200	325	200	240	180	180	260	160	250	130	230	
Recommend	◎	◎	◎	◎	◎	◎	◎	◎	◎	◎	◎	○	○	○	○	○	○	○	○	○	
ISO Material Description	N										S					H					
	Aluminum-wrought alloy		Aluminum-cast, alloyed			Copper and Copper Alloys (Bronze / Brass)			Non Metallic Materials		Heat Resistant Super Alloys					Titanium Alloys		Hardened steel	Chilled Cast Iron	Hardened Cast Iron	
VDI 3323	21	22	23	24	25	26	27	28	29	30	31	32	33	34	35	36	37	38	39	40	41
HRc											15	30	25	38	34			55	60	42	55
HB	60	100	75	90	130	110	90	100			200	280	250	350	320	400 Rm	1050 Rm	550	630	400	550
Recommend	○	○	○	○	○	○	○	○	○	○	○	○	○	○	○	○	○	○	○	○	○

CARBIDE, 2 FLUTE SHORT LENGTH

- VOLLHARTMETALL, 2 SCHNEIDEN KURZ
- Fraise carbure, 2 dents, courte
- 2 TAGLIANTI, CORTA

- ▶ Suitable for dry milling applications at high temperatures.
- ▶ Excellent high-performance end mills.
- ▶ 2 flute design for slotting.

- ▶ Für die Trockenbearbeitung.
- ▶ Hervorragendes Preis - Leistungsverhältnis.
- ▶ 2 Schneiden zum Nutenfräsen.

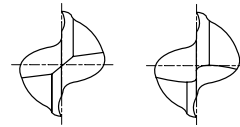

under Ø3mm from Ø3mm

Unit : mm

EDP No.	Mill Diameter	Shank Diameter	Length of Cut	Overall Length
G9424010	1.0	4	3	40
G9424015	1.5	4	4.5	40
G9424020	2.0	2	8	32
G9424025	2.5	2.5	8	32
G9424030	3.0	3	12	32
G9424035	3.5	3.5	12	32
G9424040	4.0	4	12	40
G9424045	4.5	4.5	14	50
G9424050	5.0	5	14	50
G9424055	5.5	5.5	16	50
G9424060	6.0	6	16	50
G9424070	7.0	7	20	60
G9424080	8.0	8	20	60
G9424090	9.0	9	20	60
G9424100	10.0	10	22	70
G9424120	12.0	12	22	70
G9424140	14.0	14	25	75
G9424160	16.0	16	25	75
G9424200	20.0	20	32	100

Mill Dia. Tolerance(mm)	Shank Dia. Tolerance
0 ~ -0.03	h5

◎ : Excellent ○ : Good

ISO Material Description	P										M				K						
	Non-alloy steel					Low alloy steel					High alloyed steel, and tool steel				Stainless steel		Grey cast iron		Nodular cast iron		Malleable cast iron
VDI 3323	1	2	3	4	5	6	7	8	9	10	11	12	13	14	15	16	17	18	19	20	
HRc	13	25	28	32	10	29	32	38	15	35	15	23	10	10	26	3	25	130	230		
HB	125	190	250	270	300	180	275	300	350	200	325	200	240	180	180	260	160	250	130	230	
Recommend	◎	◎	◎	◎	◎	◎	◎	◎	◎	◎	◎	○	○	○	○	○	○	○	○	○	

ISO Material Description	N					S										H					
	Aluminum-wrought alloy		Aluminum-cast, alloyed			Copper and Copper Alloys (Bronze / Brass)			Non Metallic Materials		Heat Resistant Super Alloys					Titanium Alloys		Hardened steel	Chilled Cast Iron	Hardened Cast Iron	
VDI 3323	21	22	23	24	25	26	27	28	29	30	31	32	33	34	35	36	37	38	39	40	41
HRc	60	100	75	90	130	110	90	100			200	280	250	350	320	400 Rm	1050 Rm	550	630	400	550
Recommend	○	○	○	○	○	○	○	○	○	○	○	○	○	○	○	○	○	○	○	○	○

CARBIDE, 2 FLUTE SHORT LENGTH WITH CHAMFER

- **VOLLHARTMETALL, 2 SCHNEIDEN KURZ**
- **Fraise carbure, 2 dents, courte**
- **2 TAGLIENTI, CORTA**

- ▶ Suitable for dry milling applications at high temperatures.
- ▶ Excellent high-performance end mills.
- ▶ 2 flute design for slotting.

- ▶ Für die Trockenbearbeitung.
- ▶ Hervorragendes Preis - Leistungsverhältnis.
- ▶ 2 Schneiden zum Nutenfräsen.



CARBIDE 2 30° DIN 6535HA C x 45° P.603

Unit : mm

EDP No.	Mill Diameter	Shank Diameter	Length of Cut	Overall Length	Chamfer
G9G44030	3.0	3	12	32	0.10
G9G44040	4.0	4	12	40	0.10
G9G44050	5.0	5	14	50	0.10
G9G44060	6.0	6	16	50	0.10
G9G44080	8.0	8	20	60	0.13
G9G44100	10.0	10	22	70	0.13
G9G44120	12.0	12	22	70	0.18
G9G44140	14.0	14	25	75	0.18
G9G44160	16.0	16	25	75	0.18
G9G44200	20.0	20	32	100	0.23

Mill Dia. Tolerance(mm)	Shank Dia. Tolerance
0 ~ - 0.03	h5

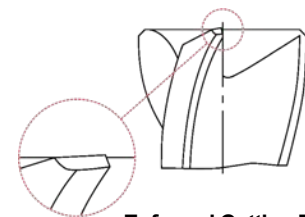

Enforced Cutting Edge

◎ : Excellent ○ : Good

ISO Material Description	P											M				K						
	Non-alloy steel					Low alloy steel						High alloyed steel, and tool steel				Stainless steel		Grey cast iron		Nodular cast iron		Malleable cast iron
VDI 3323	1	2	3	4	5	6	7	8	9	10	11	12	13	14	15	16	17	18	19	20		
HRc		13	25	28	32	10	29	32	38	15	35	15	23	10	10	26	3	25		21		
HB	125	190	250	270	300	180	275	300	350	200	325	200	240	180	180	260	160	250	130	230		
Recommend	◎	◎	◎	◎	◎	◎	◎	◎	◎	◎	◎	○	○	○	○	○	○	○	○	○		
ISO Material Description	N										S							H				
	Aluminum-wrought alloy		Aluminum-cast, alloyed			Copper and Copper Alloys (Bronze / Brass)			Non Metallic Materials		Heat Resistant Super Alloys							Titanium Alloys		Hardened steel	Chilled Cast Iron	Hardened Cast Iron
VDI 3323	21	22	23	24	25	26	27	28	29	30	31	32	33	34	35	36	37	38	39	40	41	
HRc											15	30	25	38	34			55	60	42	55	
HB	60	100	75	90	130	110	90	100			200	280	250	350	320	400 Rm	1050 Rm	550	630	400	550	
Recommend	○	○	○	○	○	○	○	○	○	○	○	○	○	○	○	○	○	○	○	○	○	

CARBIDE, 2 FLUTE SHORT LENGTH

- VOLLHARTMETALL, 2 SCHNEIDEN KURZ
- Ⓢ Fraise carbure, 2 dents, courte
- Ⓢ 2 TAGLIANTI, CORTA

- ▶ Suitable for dry milling applications at high temperatures.
- ▶ Excellent high-performance end mills.
- ▶ 2 flute design for slotting.

- ▶ Für die Trockenbearbeitung.
- ▶ Hervorragendes Preis - Leistungsverhältnis.
- ▶ 2 Schneiden zum Nutenfräsen.

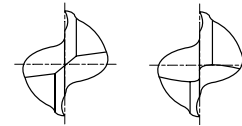
 under \varnothing 3mm from \varnothing 3mm

Unit : mm

EDP No.	Mill Diameter	Shank Diameter	Length of Cut	Overall Length
G9A68010	1.0	3	3	39
G9A68015	1.5	3	5	39
G9A68020	2.0	3	7	39
G9A68025	2.5	3	7	39
G9A68030	3.0	3	9	39
G9A68040	4.0	4	14	51
G9A68050	5.0	5	16	51
G9A68060	6.0	6	19	64
G9A68080	8.0	8	21	64
G9A68100	10.0	10	22	70
G9A68120	12.0	12	25	76
G9A68160	16.0	16	32	89
G9A68200	20.0	20	38	102

Mill Dia. Tolerance(mm)	Shank Dia. Tolerance
0 ~ - 0.03	h5

◎ : Excellent ○ : Good

ISO Material Description	P										M				K						
	Non-alloy steel					Low alloy steel					High alloyed steel, and tool steel				Stainless steel		Grey cast iron		Nodular cast iron		Malleable cast iron
VDI 3323	1	2	3	4	5	6	7	8	9	10	11	12	13	14	15	16	17	18	19	20	
HRC	13	25	28	32	10	29	32	38	10	35	15	23	10	10	26	3	25	13	21		
HB	125	190	250	270	300	180	275	300	350	200	325	200	240	180	180	260	160	250	130	230	
Recommend	◎	◎	◎	◎	◎	◎	◎	◎	◎	◎	◎	○	○	○	○	○	○	○	○	○	

ISO Material Description	N					S										H										
	Aluminum-wrought alloy		Aluminum-cast, alloyed			Copper and Copper Alloys (Bronze / Brass)			Non Metallic Materials		Heat Resistant Super Alloys					Titanium Alloys		Hardened steel	Chilled Cast Iron	Hardened Cast Iron						
VDI 3323	21	22	23	24	25	26	27	28	29	30	31	32	33	34	35	36	37	38	39	40	41					
HRC	60	100	75	90	130	110	90	100			15	30	25	38	34	200	280	250	350	320	400 Rm	1050 Rm	550	630	400	550
Recommend	○	○	○	○	○	○	○	○	○	○	○	○	○	○	○	○	○	○	○	○	○	○	○	○	○	○

CARBIDE, 2 FLUTE SHORT LENGTH

- **VOLLHARTMETALL, 2 SCHNEIDEN KURZ**
- **Fraise carbure, 2 dents, courte**
- **2 TAGLIENTI, CORTA**

- ▶ Suitable for dry milling applications at high temperatures.
- ▶ Excellent high-performance end mills.
- ▶ 2 flute design for slotting.

- ▶ Für die Trockenbearbeitung.
- ▶ Hervorragendes Preis - Leistungsverhältnis.
- ▶ 2 Schneiden zum Nutenfräsen.

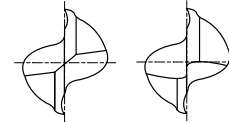

under Ø3mm from Ø3mm

CARBIDE
DIN 6527
2
≈ 30°
DIN 6535HB
P.603

Unit : mm

EDP No.	Mill Diameter	Shank Diameter	Length of Cut	Overall Length
G9444020	2.0	6	3	50
G9444030	3.0	6	4	50
G9444035	3.5	6	4	50
G9444040	4.0	6	5	54
G9444045	4.5	6	5	54
G9444050	5.0	6	6	54
G9444060	6.0	6	7	54
G9444070	7.0	8	8	58
G9444080	8.0	8	9	58
G9444090	9.0	10	10	66
G9444100	10.0	10	11	66
G9444120	12.0	12	12	73
G9444140	14.0	14	14	75
G9444160	16.0	16	16	82
G9444180	18.0	18	18	84
G9444200	20.0	20	20	92

Mill Dia. Tolerance(mm)	Shank Dia. Tolerance
0 ~ - 0.03	h5

◎ : Excellent ○ : Good

ISO Material Description	P											M			K						
	Non-alloy steel					Low alloy steel						High alloyed steel, and tool steel			Stainless steel			Grey cast iron		Nodular cast iron	
VDI 3323	1	2	3	4	5	6	7	8	9	10	11	12	13	14	15	16	17	18	19	20	
HRc		13	25	28	32	10	29	32	38	15	35	15	23	10	10	26	3	25		21	
HB	125	190	250	270	300	180	275	300	350	200	325	200	240	180	180	260	160	250	130	230	
Recommend	◎	◎	◎	◎	◎	◎	◎	◎	◎	◎	◎	○	○	○	○	○	○	○	○	○	
ISO Material Description	N										S							H			
	Aluminum-wrought alloy		Aluminum-cast, alloyed			Copper and Copper Alloys (Bronze / Brass)			Non Metallic Materials		Heat Resistant Super Alloys					Titanium Alloys		Hardened steel	Chilled Cast Iron	Hardened Cast Iron	
VDI 3323	21	22	23	24	25	26	27	28	29	30	31	32	33	34	35	36	37	38	39	40	41
HRc											15	30	25	38	34			55	60	42	55
HB	60	100	75	90	130	110	90	100			200	280	250	350	320	400 Rm	1050 Rm	550	630	400	550
Recommend	○	○	○	○	○	○	○	○	○	○	○	○	○	○	○	○	○	○	○	○	○

CARBIDE, 2 FLUTE LONG LENGTH

- VOLLHARTMETALL, 2 SCHNEIDEN LANG
- Fraise carbure, 2 dents, longue
- 2 TAGLIANTI, SERIE LUNGA

- ▶ Suitable for dry milling applications at high temperatures.
- ▶ Excellent high-performance end mills.
- ▶ 2 flute design for slotting.

- ▶ Für die Trockenbearbeitung.
- ▶ Hervorragendes Preis - Leistungsverhältnis.
- ▶ 2 Schneiden zum Nutenfräsen.

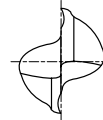

Unit : mm

EDP No.	Mill Diameter	Shank Diameter	Length of Cut	Overall Length
G9527035	3.5	3.5	7	50
G9527040	4.0	4	8	50
G9527045	4.5	4.5	8	50
G9527050	5.0	5	10	50
G9527055	5.5	5.5	10	57
G9527060	6.0	6	10	57
G9527065	6.5	6.5	13	60
G9527070	7.0	7	13	60
G9527075	7.5	7.5	16	63
G9527080	8.0	8	16	63
G9527085	8.5	8.5	16	67
G9527090	9.0	9	16	67
G9527095	9.5	9.5	19	72
G9527100	10.0	10	19	72
G9527110	11.0	11	22	83
G9527120	12.0	12	22	83
G9527130	13.0	13	22	83
G9527140	14.0	14	22	83
G9527150	15.0	15	26	92
G9527160	16.0	16	26	92
G9527180	18.0	18	26	92
G9527200	20.0	20	32	104

Mill Dia. Tolerance(mm)	Shank Dia. Tolerance
0 ~ - 0.03	h5

◎ : Excellent ○ : Good

ISO Material Description	P										M				K						
	Non-alloy steel					Low alloy steel					High alloyed steel, and tool steel				Stainless steel		Grey cast iron		Nodular cast iron		Malleable cast iron
VDI 3323	1	2	3	4	5	6	7	8	9	10	11	12	13	14	15	16	17	18	19	20	
HRC		13	25	28	32	10	29	32	38	15	35	15	23	10	10	26	3	25	42	21	
HB	125	190	250	270	300	180	275	300	350	200	325	200	240	180	180	260	160	250	130	230	
Recommend	◎	◎	◎	◎	◎	◎	◎	◎	◎	◎	◎	○	○	○	○	○	○	○	○	○	

ISO Material Description	N					S										H					
	Aluminum-wrought alloy		Aluminum-cast, alloyed			Copper and Copper Alloys (Bronze / Brass)			Non Metallic Materials		Heat Resistant Super Alloys					Titanium Alloys		Hardened steel	Chilled Cast Iron	Hardened Cast Iron	
VDI 3323	21	22	23	24	25	26	27	28	29	30	31	32	33	34	35	36	37	38	39	40	41
HRC											15	30	25	38	34			55	60	42	55
HB	60	100	75	90	130	110	90	100			200	280	250	350	320	400 Rm	1050 Rm	550	630	400	550
Recommend	○	○	○	○	○	○	○	○	○	○	○	○	○	○	○	○	○	○	○	○	○

CARBIDE, 2 FLUTE LONG LENGTH

- **VOLLHARTMETALL, 2 SCHNEIDEN LANG**
- **Fraise carbure, 2 dents, longue**
- **2 TAGLIENTI, SERIE LUNGA**

- ▶ Suitable for dry milling applications at high temperatures.
- ▶ Excellent high-performance end mills.
- ▶ 2 flute design for slotting.

- ▶ Für die Trockenbearbeitung.
- ▶ Hervorragendes Preis - Leistungsverhältnis.
- ▶ 2 Schneiden zum Nutenfräsen.

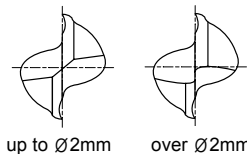

up to Ø2mm

over Ø2mm

CARBIDE
DIN 6527
2
≈ 30°
DIN 6535HA
DIN 6535HB
P.603

Unit : mm

EDP No.	Mill Diameter	Shank Diameter	Length of Cut	Overall Length
G9445901	2.0	● 3	6	38
G9445028	2.8	6	7	57
G9445030	3.0	6	7	57
G9445035	3.5	6	7	57
G9445038	3.8	6	8	57
G9445040	4.0	6	8	57
G9445045	4.5	6	8	57
G9445048	4.8	6	10	57
G9445050	5.0	6	10	57
G9445957	5.8	6	10	57
G9445060	6.0	6	10	57
G9445967	6.8	8	13	63
G9445070	7.0	8	13	63
G9445977	7.8	8	16	63
G9445080	8.0	8	16	63
G9445087	8.7	10	16	72
G9445090	9.0	10	16	72
G9445097	9.7	10	19	72
G9445100	10.0	10	19	72
G9445117	11.7	12	22	83
G9445120	12.0	12	22	83
G9445137	13.7	14	22	83
G9445140	14.0	14	22	83

● with plain shank

▶ NEXT PAGE

Mill Dia. Tolerance(mm)	Shank Dia. Tolerance
0 ~ - 0.03	h5

◎ : Excellent ○ : Good

ISO Material Description	P										M				K						
	Non-alloy steel					Low alloy steel					High alloyed steel, and tool steel				Stainless steel		Grey cast iron		Nodular cast iron		Malleable cast iron
VDI 3323	1	2	3	4	5	6	7	8	9	10	11	12	13	14	15	16	17	18	19	20	
HRc		13	25	28	32	10	29	32	38	15	35	15	23	10	10	26	3	25		21	
HB	125	190	250	270	300	180	275	300	350	200	325	200	240	180	180	260	160	250	130	230	
Recommend	◎	◎	◎	◎	◎	◎	◎	◎	◎	◎	◎	○	○	○	○	○	○	○	○	○	
ISO Material Description	N										S							H			
	Aluminum-wrought alloy		Aluminum-cast, alloyed			Copper and Copper Alloys (Bronze / Brass)			Non Metallic Materials		Heat Resistant Super Alloys					Titanium Alloys		Hardened steel	Chilled Cast Iron	Hardened Cast Iron	
VDI 3323	21	22	23	24	25	26	27	28	29	30	31	32	33	34	35	36	37	38	39	40	41
HRc											15	30	25	38	34			55	60	42	55
HB	60	100	75	90	130	110	90	100			200	280	250	350	320	400 Rm	1050 Rm	550	630	400	550
Recommend	○	○	○	○	○	○	○	○	○	○	○	○	○	○	○	○	○	○	○	○	○

CARBIDE, 2 FLUTE LONG LENGTH

- VOLLHARTMETALL, 2 SCHNEIDEN LANG
- ⊖ Fraise carbure, 2 dents, longue
- ⊖ 2 TAGLIANTI, SERIE LUNGA

- ▶ Suitable for dry milling applications at high temperatures.
- ▶ Excellent high-performance end mills.
- ▶ 2 flute design for slotting.

- ▶ Für die Trockenbearbeitung.
- ▶ Hervorragendes Preis - Leistungsverhältnis.
- ▶ 2 Schneiden zum Nutenfräsen.

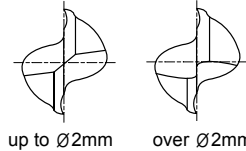

CARBIDE
DIN 6527
2
30°
DIN 6535HA
DIN 6535HB
P.603

Unit : mm

EDP No.	Mill Diameter	Shank Diameter	Length of Cut	Overall Length
G9445157	15.7	16	26	92
G9445160	16.0	16	26	92
G9445177	17.7	18	26	92
G9445180	18.0	18	26	92
G9445197	19.7	20	32	104
G9445200	20.0	20	32	104

Mill Dia. Tolerance(mm)	Shank Dia. Tolerance
0 ~ - 0.03	h5

◎ : Excellent ○ : Good

ISO Material Description	P										M				K						
	Non-alloy steel					Low alloy steel					High alloyed steel, and tool steel				Stainless steel		Grey cast iron		Nodular cast iron		Malleable cast iron
VDI 3323	1	2	3	4	5	6	7	8	9	10	11	12	13	14	15	16	17	18	19	20	
HRC	13	13	25	28	32	10	29	32	38	15	35	15	23	10	10	26	3	25	42	55	
HB	125	190	250	270	300	180	275	300	350	200	325	200	240	180	180	260	160	250	130	230	
Recommend	◎	◎	◎	◎	◎	◎	◎	◎	◎	◎	◎	○	○	○	○	○	○	○	○	○	
ISO Material Description	N										S						H				
	Aluminum-wrought alloy		Aluminum-cast, alloyed			Copper and Copper Alloys (Bronze / Brass)			Non Metallic Materials		Heat Resistant Super Alloys						Titanium Alloys		Hardened steel	Chilled Cast Iron	Hardened Cast Iron
VDI 3323	21	22	23	24	25	26	27	28	29	30	31	32	33	34	35	36	37	38	39	40	41
HRC	60	100	75	90	130	110	90	100			200	280	250	350	320	400 Rm	1050 Rm	550	630	400	550
Recommend	○	○	○	○	○	○	○	○	○	○	○	○	○	○	○	○	○	○	○	○	○

CARBIDE, 2 FLUTE LONG LENGTH WITH CHAMFER

- **VOLLHARTMETALL, 2 SCHNEIDEN LANG**
- **Fraise carbure, 2 dents, longue**
- **2 TAGLIENTI, SERIE LUNGA**

- ▶ Suitable for dry milling applications at high temperatures.
- ▶ Excellent high-performance end mills.
- ▶ 2 flute design for slotting.

- ▶ Für die Trockenbearbeitung.
- ▶ Hervorragendes Preis - Leistungsverhältnis.
- ▶ 2 Schneiden zum Nutenfräsen.

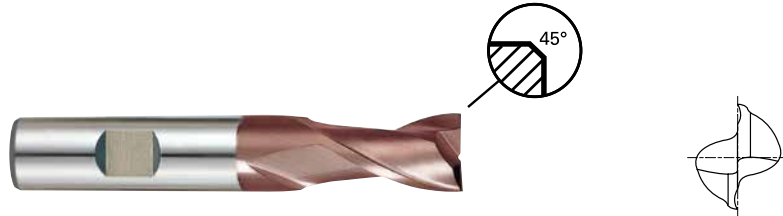

CARBIDE
DIN 6527
2
≈ 30°
DIN 6535HB
C x 45°
P.603

Unit : mm

EDP No.	Mill Diameter	Shank Diameter	Length of Cut	Overall Length	Chamfer
G9G45030	3.0	6	7	57	0.10
G9G45040	4.0	6	8	57	0.10
G9G45050	5.0	6	10	57	0.10
G9G45060	6.0	6	10	57	0.10
G9G45080	8.0	8	16	63	0.13
G9G45100	10.0	10	19	72	0.13
G9G45120	12.0	12	22	83	0.18
G9G45140	14.0	14	22	83	0.18
G9G45160	16.0	16	26	92	0.18
G9G45200	20.0	20	32	104	0.23

Mill Dia. Tolerance(mm)	Shank Dia. Tolerance
0 ~ - 0.03	h5

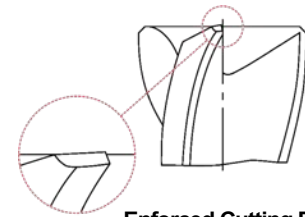

Enforced Cutting Edge

◎ : Excellent ○ : Good

ISO Material Description	P										M				K											
	Non-alloy steel					Low alloy steel					High alloyed steel, and tool steel				Stainless steel		Grey cast iron		Nodular cast iron		Malleable cast iron					
VDI 3323	1	2	3	4	5	6	7	8	9	10	11	12	13	14	15	16	17	18	19	20						
HRc	13	25	28	32	30	29	32	38	15	35	15	23	10	10	26	3	25	42	55							
HB	125	190	250	270	300	180	275	300	350	200	325	200	240	180	180	260	160	250	130	230						
Recommend	◎	◎	◎	◎	◎	◎	◎	◎	◎	◎	◎	○	○	○	○	○	○	○	○	○						
ISO Material Description	N										S						H									
	Aluminum-wrought alloy		Aluminum-cast, alloyed			Copper and Copper Alloys (Bronze / Brass)			Non Metallic Materials		Heat Resistant Super Alloys						Titanium Alloys		Hardened steel	Chilled Cast Iron	Hardened Cast Iron					
VDI 3323	21	22	23	24	25	26	27	28	29	30	31	32	33	34	35	36	37	38	39	40	41					
HRc	60	100	75	90	130	110	90	100			15	30	25	38	34	200	280	250	350	320	400 Rm	1050 Rm	550	630	400	550
HB	60	100	75	90	130	110	90	100			200	280	250	350	320	400 Rm	1050 Rm	550	630	400	550					
Recommend	○	○	○	○	○	○	○	○	○	○	○	○	○	○	○	○	○	○	○	○	○	○	○	○	○	○

CARBIDE, 2 FLUTE EXTRA LONG LENGTH

- VOLLHARTMETALL, 2 SCHNEIDEN EXTRA LANG
- Fraise carbure, 2 dents, extra-longue
- 2 TAGLIANTI, SERIE EXTRA LUNGA

- ▶ Suitable for dry milling applications at high temperatures.
- ▶ Excellent high-performance end mills.
- ▶ 2 flute design for slotting.

- ▶ Für die Trockenbearbeitung.
- ▶ Hervorragendes Preis - Leistungsverhältnis.
- ▶ 2 Schneiden zum Nutenfräsen.

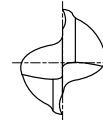

Unit : mm

EDP No.	Mill Diameter	Shank Diameter	Length of Cut	Overall Length
G9452903	3.0	3	20	60
G9452030	3.0	3	30	75
G9452904	4.0	4	20	60
G9452040	4.0	4	30	75
G9452905	5.0	5	25	75
G9452050	5.0	5	40	100
G9452906	6.0	6	30	75
G9452060	6.0	6	50	150
G9452908	8.0	8	30	75
G9452080	8.0	8	50	150
G9452910	10.0	10	40	100
G9452100	10.0	10	60	150
G9452912	12.0	12	45	100
G9452120	12.0	12	75	150
G9452914	14.0	14	45	100
G9452140	14.0	14	65	150
G9452916	16.0	16	45	100
G9452160	16.0	16	65	150
G9452918	18.0	18	45	100
G9452180	18.0	18	65	150
G9452920	20.0	20	45	100
G9452200	20.0	20	65	150

Mill Dia. Tolerance(mm)	Shank Dia. Tolerance
0 ~ - 0.03	h5

◎ : Excellent ○ : Good

ISO Material Description	P										M				K						
	Non-alloy steel					Low alloy steel					High alloyed steel, and tool steel				Stainless steel		Grey cast iron		Nodular cast iron		Malleable cast iron
VDI 3323	1	2	3	4	5	6	7	8	9	10	11	12	13	14	15	16	17	18	19	20	
HRC	125	130	250	270	300	180	275	300	350	200	325	200	240	180	180	260	160	250	130	230	
Recommend	◎	◎	◎	◎	◎	◎	◎	◎	◎	◎	◎	◎	○	○	○	○	○	○	○	○	

ISO Material Description	N					S										H					
	Aluminum-wrought alloy		Aluminum-cast, alloyed			Copper and Copper Alloys (Bronze / Brass)			Non Metallic Materials		Heat Resistant Super Alloys					Titanium Alloys		Hardened steel	Chilled Cast Iron	Hardened Cast Iron	
VDI 3323	21	22	23	24	25	26	27	28	29	30	31	32	33	34	35	36	37	38	39	40	41
HRC	60	100	75	90	130	110	90	100			200	280	250	350	320	400 Rm	1050 Rm	550	630	400	550
Recommend	○	○	○	○	○	○	○	○	○	○	○	○	○	○	○	○	○	○	○	○	○

CARBIDE, 2 FLUTE RIB PROCESSING

- **VOLLHARTMETALL, 2 SCHNEIDEN SCHMALE RIPPEN**
- **Fraise carbure, 2 dents pour usinage de rainure**
- **2 TAGLIENTI, SCARICATA PER NERVATURE**

- ▶ Suitable for dry milling applications at high temperatures.
- ▶ Excellent high-performance end mills.
- ▶ 2 flute design for slotting.

- ▶ Für die Trockenbearbeitung.
- ▶ Hervorragendes Preis - Leistungsverhältnis.
- ▶ 2 Schneiden zum Nutenfräsen.

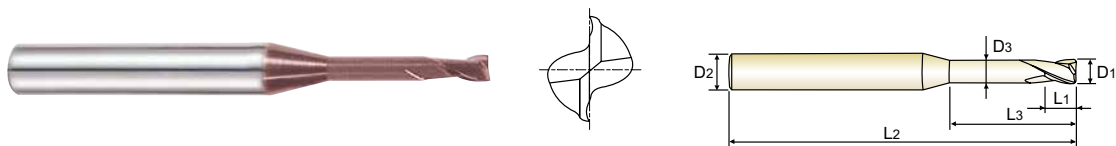

Unit : mm

EDP No.	Mill Diameter	Shank Diameter	Length of Cut	Length Below Shank	Overall Length	Neck Diameter
	D1	D2	L1	L3	D3	D3
G9B80004	0.4	4	0.7	2	50	0.37
G9B80901	0.4	4	0.7	4	50	0.37
G9B80005	0.5	4	0.75	2	50	0.45
G9B80902	0.5	4	0.75	4	50	0.45
G9B80903	0.5	4	0.75	6	50	0.45
G9B80006	0.6	4	0.9	2	50	0.55
G9B80904	0.6	4	0.9	4	50	0.55
G9B80905	0.6	4	0.9	6	50	0.55
G9B80007	0.7	4	1.1	4	50	0.65
G9B80906	0.7	4	1.1	6	50	0.65
G9B80008	0.8	4	1.2	4	50	0.75
G9B80907	0.8	4	1.2	6	50	0.75
G9B80908	0.8	4	1.2	8	50	0.75
G9B80009	0.9	4	1.4	6	50	0.85
G9B80909	0.9	4	1.4	8	50	0.85
G9B80910	0.9	4	1.4	10	50	0.85
G9B80010	1.0	4	1.5	6	50	0.95
G9B80911	1.0	4	1.5	8	50	0.95
G9B80912	1.0	4	1.5	10	50	0.95
G9B80913	1.0	4	1.5	12	50	0.95
G9B80012	1.2	4	1.8	6	50	1.15
G9B80914	1.2	4	1.8	8	50	1.15
G9B80915	1.2	4	1.8	10	50	1.15
G9B80916	1.2	4	1.8	12	50	1.15

▶ NEXT PAGE

Mill Dia. Tolerance(mm)	Shank Dia. Tolerance
0 ~ - 0.03	h5

◎ : Excellent ○ : Good

ISO Material Description	P										M				K						
	Non-alloy steel					Low alloy steel					High alloyed steel, and tool steel				Stainless steel		Grey cast iron		Nodular cast iron		Malleable cast iron
VDI 3323	1	2	3	4	5	6	7	8	9	10	11	12	13	14	15	16	17	18	19	20	
HRc		13	25	28	32	10	29	32	38	15	35	15	23	10	10	26	3	25		21	
HB	125	190	250	270	300	180	275	300	350	200	325	200	240	180	180	260	160	250	130	230	
Recommend	◎	◎	◎	◎	◎	◎	◎	◎	◎	◎	◎	○	○	○	○	○	○	○	○	○	
ISO Material Description	N										S							H			
	Aluminum-wrought alloy		Aluminum-cast, alloyed			Copper and Copper Alloys (Bronze / Brass)			Non Metallic Materials		Heat Resistant Super Alloys							Titanium Alloys		Hardened steel	Chilled Cast Iron
VDI 3323	21	22	23	24	25	26	27	28	29	30	31	32	33	34	35	36	37	38	39	40	41
HRc											15	30	25	38	34			55	60	42	55
HB	60	100	75	90	130	110	90	100			200	280	250	350	320	400 Rm	1050 Rm	550	630	400	550
Recommend	○	○	○	○	○	○	○	○													

CARBIDE, 2 FLUTE RIB PROCESSING

- VOLLHARTMETALL, 2 SCHNEIDEN SCHMALE RIPPEN
- Fraise carbure, 2 dents pour usinage de rainure
- 2 TAGLIANTI, SCARICATA PER NERVATURE

- ▶ Suitable for dry milling applications at high temperatures.
- ▶ Excellent high-performance end mills.
- ▶ 2 flute design for slotting.

- ▶ Für die Trockenbearbeitung.
- ▶ Hervorragendes Preis - Leistungsverhältnis.
- ▶ 2 Schneiden zum Nutenfräsen.

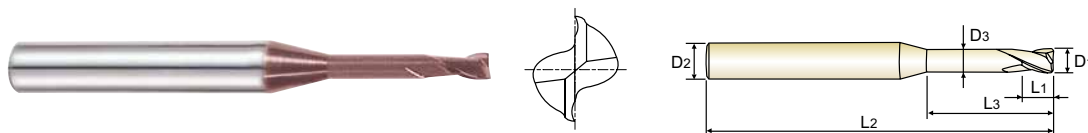

Unit : mm

EDP No.	Mill Diameter	Shank Diameter	Length of Cut	Length Below Shank	Overall Length	Neck Diameter
	D1	D2	L1	L3	D3	D3
G9B80015	1.5	4	2.3	6	50	1.45
G9B80917	1.5	4	2.3	8	50	1.45
G9B80918	1.5	4	2.3	10	50	1.45
G9B80919	1.5	4	2.3	12	50	1.45
G9B80920	1.5	4	2.3	14	50	1.45
G9B80921	1.5	4	2.3	16	50	1.45
G9B80922	1.5	4	2.3	18	50	1.45
G9B80923	1.5	4	2.3	20	50	1.45
G9B80020	2.0	4	3	6	50	1.95
G9B80924	2.0	4	3	8	50	1.95
G9B80925	2.0	4	3	10	50	1.95
G9B80926	2.0	4	3	12	50	1.95
G9B80927	2.0	4	3	14	50	1.95
G9B80928	2.0	4	3	16	50	1.95
G9B80929	2.0	4	3	18	50	1.95
G9B80930	2.0	4	3	20	50	1.95
G9B80025	2.5	4	3.7	8	50	2.40
G9B80931	2.5	4	3.7	12	50	2.40
G9B80932	2.5	4	3.7	16	50	2.40
G9B80933	2.5	4	3.7	20	50	2.40

▶ NEXT PAGE

Mill Dia. Tolerance(mm)	Shank Dia. Tolerance
0 ~ - 0.03	h5

◎ : Excellent ○ : Good

ISO Material Description	P										M				K						
	Non-alloy steel					Low alloy steel					High alloyed steel, and tool steel				Stainless steel		Grey cast iron		Nodular cast iron		Malleable cast iron
VDI 3323	1	2	3	4	5	6	7	8	9	10	11	12	13	14	15	16	17	18	19	20	
HRC	13	25	28	32	10	29	32	38	15	35	15	23	10	10	26	3	25	130	230		
HB	125	190	250	270	300	180	275	300	350	200	325	200	240	180	180	260	160	250	130	230	
Recommend	◎	◎	◎	◎	◎	◎	◎	◎	◎	◎	◎	◎	◎	◎	◎	◎	◎	◎	◎	◎	

ISO Material Description	N										S						H								
	Aluminum-wrought alloy		Aluminum-cast, alloyed			Copper and Copper Alloys (Bronze / Brass)			Non Metallic Materials		Heat Resistant Super Alloys						Titanium Alloys		Hardened steel	Chilled Cast Iron	Hardened Cast Iron				
VDI 3323	21	22	23	24	25	26	27	28	29	30	31	32	33	34	35	36	37	38	39	40	41				
HRC	60	100	75	90	130	110	90	100			15	30	25	38	34	200	280	250	350	400 Rm	1050 Rm	550	630	400	550
Recommend	◎	◎	◎	◎	◎	◎	◎	◎	◎	◎	◎	◎	◎	◎	◎	◎	◎	◎	◎	◎	◎	◎	◎	◎	◎

CARBIDE, 2 FLUTE RIB PROCESSING

- **VOLLHARTMETALL, 2 SCHNEIDEN SCHMALE RIPPEN**
- **Fraise carbure, 2 dents pour usinage de rainure**
- **2 TAGLIENTI, SCARICATA PER NERVATURE**

- ▶ Suitable for dry milling applications at high temperatures.
- ▶ Excellent high-performance end mills.
- ▶ 2 flute design for slotting.

- ▶ Für die Trockenbearbeitung.
- ▶ Hervorragendes Preis - Leistungsverhältnis.
- ▶ 2 Schneiden zum Nutenfräsen.

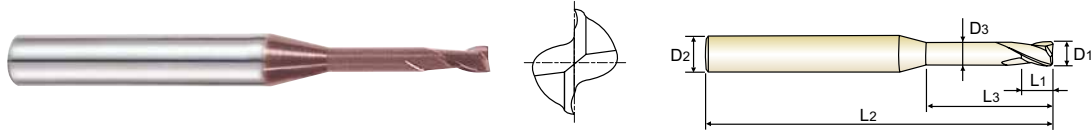

Unit : mm

EDP No.	Mill Diameter	Shank Diameter	Length of Cut	Length Below Shank	Overall Length	Neck Diameter
	D1	D2	L1	L3	D3	D3
G9B80030	3.0	6	4.5	8	50	2.85
G9B80934	3.0	6	4.5	12	50	2.85
G9B80935	3.0	6	4.5	16	60	2.85
G9B80936	3.0	6	4.5	20	60	2.85
G9B80937	3.0	6	4.5	25	75	2.85
G9B80040	4.0	6	6	12	50	3.85
G9B80938	4.0	6	6	16	60	3.85
G9B80939	4.0	6	6	20	75	3.85
G9B80940	4.0	6	6	25	75	3.85
G9B80941	4.0	6	6	30	75	3.85
G9B80942	4.0	6	6	35	75	3.85

Mill Dia. Tolerance(mm)	Shank Dia. Tolerance
0 ~ -0.03	h5

K-2
END MILLS

◎ : Excellent ○ : Good

ISO Material Description	P											M			K						
	Non-alloy steel					Low alloy steel				High alloyed steel, and tool steel		Stainless steel			Grey cast iron		Nodular cast iron		Malleable cast iron		
VDI 3323	1	2	3	4	5	6	7	8	9	10	11	12	13	14	15	16	17	18	19	20	
HRc	13	25	28	32	10	29	32	38	15	35	15	23	10	10	26	3	25		21		
HB	125	190	250	270	300	180	275	300	350	200	325	200	240	180	180	260	160	250	130	230	
Recommend	◎	◎	◎	◎	◎	◎	◎	◎	◎	◎	◎	○	○	○	○	○	○	○	○	○	
ISO Material Description	N										S					H					
	Aluminum-wrought alloy		Aluminum-cast, alloyed			Copper and Copper Alloys (Bronze / Brass)			Non Metallic Materials		Heat Resistant Super Alloys					Titanium Alloys		Hardened steel	Chilled Cast Iron	Hardened Cast Iron	
VDI 3323	21	22	23	24	25	26	27	28	29	30	31	32	33	34	35	36	37	38	39	40	41
HRc											15	30	25	38	34			55	60	42	55
HB	60	100	75	90	130	110	90	100			200	280	250	350	320	400 Rm	1050 Rm	550	630	400	550
Recommend	○	○	○	○	○	○	○	○													

CARBIDE, 3 FLUTE SHORT LENGTH THROW AWAY

● VOLLHARTMETALL, 3 SCHNEIDEN KURZ EINWEGFRÄSER

⊕ Fraise carbure, 3 dents, à jeter, courte

⊕ 3 TAGLIANTI, SERIE EXTRA CORTA

- ▶ Suitable for dry milling applications at high temperatures.
- ▶ Excellent high-performance end mills.
- ▶ 3 flute design possesses the advantage of 2 flute and 4 flute end mill.

- ▶ Für die Trockenbearbeitung.
- ▶ Hervorragendes Preis - Leistungsverhältnis.
- ▶ 3 Schneiden verbinden die Vorteile von 2 - und 4 - schneidigen Schaffräsern.

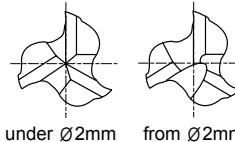

Unit : mm

EDP No.		Mill Diameter	Shank Diameter	Length of Cut	Overall Length
PLAIN	FLAT				
G9553005	-	0.5	3	1.5	38
G9553006	-	0.6	3	1.5	38
G9553008	-	0.8	3	2	38
G9553010	-	1.0	3	2	38
G9553012	-	1.2	3	2	38
G9553015	-	1.5	3	2	38
G9553018	-	1.8	3	2	38
-	G9410020	2.0	6	4	35
-	G9410025	2.5	6	5	36
-	G9410030	3.0	6	5	36
-	G9410035	3.5	6	6	37
-	G9410040	4.0	6	7	38
-	G9410045	4.5	6	8	38
-	G9410050	5.0	6	8	39
-	G9410055	5.5	6	8	39
-	G9410957	5.8	6	8	39
-	G9410060	6.0	6	8	39
-	G9410967	6.8	8	10	42
-	G9410070	7.0	8	10	42
-	G9410977	7.8	8	10	42
-	G9410080	8.0	8	11	43
-	G9410087	8.7	10	11	48
-	G9410090	9.0	10	11	48
-	G9410097	9.7	10	11	48

▶ NEXT PAGE

Mill Dia. Tolerance(mm)	Shank Dia. Tolerance
0 ~ - 0.03	h5

◎ : Excellent ○ : Good

ISO Material Description	P											M				K					
	Non-alloy steel					Low alloy steel				High alloyed steel, and tool steel		Stainless steel		Grey cast iron		Nodular cast iron		Malleable cast iron			
VDI 3323	1	2	3	4	5	6	7	8	9	10	11	12	13	14	15	16	17	18	19	20	
HRC		13	25	28	32	10	29	32	38	15	35	15	23	10	10	26	3	25		21	
HB	125	190	250	270	300	180	275	300	350	200	325	200	240	180	180	260	160	250	130	230	
Recommend	◎	◎	◎	◎	◎	◎	◎	◎	◎	◎	◎	○	○	○	○	○	○	○	○	○	

ISO Material Description	N										S						H				
	Aluminum-wrought alloy		Aluminum-cast, alloyed			Copper and Copper Alloys (Bronze / Brass)		Non Metallic Materials			Heat Resistant Super Alloys				Titanium Alloys		Hardened steel	Chilled Cast Iron	Hardened Cast Iron		
VDI 3323	21	22	23	24	25	26	27	28	29	30	31	32	33	34	35	36	37	38	39	40	41
HRC											15	30	25	38	34			55	60	42	55
HB	60	100	75	90	130	110	90	100			200	280	250	350	320	400 Rm	1050 Rm	550	630	400	550
Recommend	○	○	○	○	○	○	○	○	○	○	○	○	○	○	○	○	○	○	○	○	○



FLAT SHANK

G9410 SERIES

PLAIN SHANK

G9553 SERIES

CARBIDE, 3 FLUTE SHORT LENGTH THROW AWAY

- **VOLLHARTMETALL, 3 SCHNEIDEN KURZ EINWEGFRÄSER**
- **Fraise carbure, 3 dents, à jeter, courte**
- **3 TAGLIENTI, SERIE EXTRA CORTA**

- ▶ Suitable for dry milling applications at high temperatures.
- ▶ Excellent high-performance end mills.
- ▶ 3 flute design possesses the advantage of 2 flute and 4 flute end mill.
- ▶ Für die Trockenbearbeitung.
- ▶ Hervorragendes Preis - Leistungsverhältnis.
- ▶ 3 Schneiden verbinden die Vorteile von 2 - und 4 - schneidigen Schafffräsern.

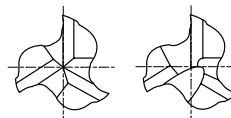

under \varnothing 2mm from \varnothing 2mm

CARBIDE 3 30° PLAIN FLAT P.606-607

Unit : mm

EDP No.	Mill Diameter	Shank Diameter	Length of Cut	Overall Length	
					PLAIN
-	G9410100	10.0	10	13	50
-	G9410120	12.0	12	15	55
-	G9410140	14.0	14	15	58
-	G9410160	16.0	16	18	62
-	G9410180	18.0	18	20	70
-	G9410200	20.0	20	22	75

Mill Dia. Tolerance(mm)	Shank Dia. Tolerance
0 ~ - 0.03	h5

◎ : Excellent ○ : Good

ISO Material Description	P										M					K						
	Non-alloy steel					Low alloy steel					High alloyed steel, and tool steel					Stainless steel			Grey cast iron		Nodular cast iron	
VDI 3323	1	2	3	4	5	6	7	8	9	10	11	12	13	14	15	16	17	18	19	20		
HRc	13	25	28	32	30	10	29	32	38	15	35	15	23	10	10	26	3	25	21			
HB	125	190	250	270	300	180	275	300	350	200	325	200	240	180	180	260	160	250	130	230		
Recommend	◎	◎	◎	◎	◎	◎	◎	◎	◎	◎	◎	○	○	○	○	○	○	○	○	○		
ISO Material Description	N										S							H				
	Aluminum-wrought alloy		Aluminum-cast, alloyed			Copper and Copper Alloys (Bronze / Brass)			Non Metallic Materials		Heat Resistant Super Alloys					Titanium Alloys		Hardened steel	Chilled Cast Iron	Hardened Cast Iron		
VDI 3323	21	22	23	24	25	26	27	28	29	30	31	32	33	34	35	36	37	38	39	40	41	
HRc											15	30	25	38	34			55	60	42	55	
HB	60	100	75	90	130	110	90	100			200	280	250	350	320	400 Rm	1050 Rm	550	630	400	550	
Recommend	○	○	○	○	○	○	○	○	○	○	○	○	○	○	○	○	○	○	○	○	○	○

CARBIDE, 3 FLUTE SHORT LENGTH THROW AWAY WITH CHAMFER

● VOLLHARTMETALL, 3 SCHNEIDEN KURZ EINWEGFRÄSER

○ Fraise carbure, 3 dents, à jeter, courte

○ 3 TAGLIANTI, SERIE EXTRA CORTA

- ▶ Suitable for dry milling applications at high temperatures.
- ▶ Excellent high-performance end mills.
- ▶ 3 flute design possesses the advantage of 2 flute and 4 flute end mill.

- ▶ Für die Trockenbearbeitung.
- ▶ Hervorragendes Preis - Leistungsverhältnis.
- ▶ 3 Schneiden verbinden die Vorteile von 2 - und 4 - schneidigen Schafffräsern.

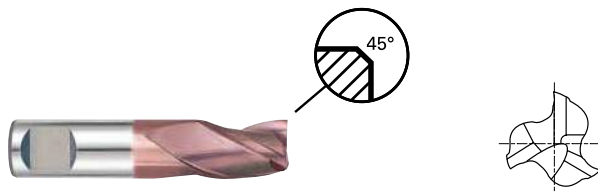

Unit : mm

EDP No.	Mill Diameter	Shank Diameter	Length of Cut	Overall Length	Chamfer
G9G46030	3.0	6	5	36	0.1
G9G46040	4.0	6	7	38	0.1
G9G46050	5.0	6	8	39	0.1
G9G46060	6.0	6	8	39	0.1
G9G46080	8.0	8	11	43	0.13
G9G46100	10.0	10	13	50	0.13
G9G46120	12.0	12	15	55	0.18
G9G46140	14.0	14	15	58	0.18
G9G46160	16.0	16	18	62	0.18
G9G46200	20.0	20	22	75	0.23

Mill Dia. Tolerance(mm)	Shank Dia. Tolerance
0 ~ -0.03	h5

◎ : Excellent ○ : Good

ISO Material Description	P										M				K						
	Non-alloy steel					Low alloy steel					High alloyed steel, and tool steel				Stainless steel		Grey cast iron		Nodular cast iron		Malleable cast iron
VDI 3323	1	2	3	4	5	6	7	8	9	10	11	12	13	14	15	16	17	18	19	20	
HRC	125	13	25	28	32	10	29	32	38	15	35	15	23	10	10	26	3	25	42	21	
HB	125	190	250	270	300	180	275	300	350	200	325	200	240	180	180	260	160	250	130	230	
Recommend	◎	◎	◎	◎	◎	◎	◎	◎	◎	◎	◎	○	○	○	○	○	○	○	○	○	
ISO Material Description	N										S						H				
	Aluminum-wrought alloy		Aluminum-cast, alloyed			Copper and Copper Alloys (Bronze / Brass)			Non Metallic Materials		Heat Resistant Super Alloys						Titanium Alloys		Hardened steel	Chilled Cast Iron	Hardened Cast Iron
VDI 3323	21	22	23	24	25	26	27	28	29	30	31	32	33	34	35	36	37	38	39	40	41
HRC	60	100	75	90	130	110	90	100			200	280	250	350	320	400 Rm	1050 Rm	550	630	400	550
HB	60	100	75	90	130	110	90	100			200	280	250	350	320	400 Rm	1050 Rm	550	630	400	550
Recommend	○	○	○	○	○	○	○	○	○	○	○	○	○	○	○	○	○	○	○	○	○

CARBIDE, 3 FLUTE SHORT LENGTH

- **VOLLHARTMETALL, 3 SCHNEIDEN KURZ**
- **Fraise carbure, 3 dents, courte**
- **3 TAGLIENTI, SERIE CORTA**

- ▶ Suitable for dry milling applications at high temperatures.
- ▶ Excellent high-performance end mills.
- ▶ 3 flute design possesses the advantage of 2 flute and 4 flute end mill.
- ▶ Für die Trockenbearbeitung.
- ▶ Hervorragendes Preis - Leistungsverhältnis.
- ▶ 3 Schneiden verbinden die Vorteile von 2 - und 4 - schneidigen Schafffräsern.

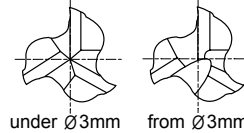

CARBIDE 3 30° DIN 6535HA P.606-607

Unit : mm

EDP No.	Mill Diameter	Shank Diameter	Length of Cut	Overall Length
G9425010	1.0	4	3	40
G9425015	1.5	4	4.5	40
G9425020	2.0	2	8	32
G9425025	2.5	3	8	32
G9425030	3.0	3	12	32
G9425035	3.5	4	12	32
G9425040	4.0	4	12	40
G9425045	4.5	5	14	50
G9425050	5.0	5	14	50
G9425055	5.5	6	16	50
G9425060	6.0	6	16	50
G9425070	7.0	7	20	60
G9425080	8.0	8	20	60
G9425090	9.0	9	20	60
G9425100	10.0	10	22	70
G9425120	12.0	12	22	70
G9425140	14.0	14	25	75
G9425160	16.0	16	25	75
G9425200	20.0	20	32	100

Mill Dia. Tolerance(mm)	Shank Dia. Tolerance
0 ~ - 0.03	h5

◎ : Excellent ○ : Good

ISO Material Description	P											M			K						
	Non-alloy steel					Low alloy steel				High alloyed steel, and tool steel		Stainless steel			Grey cast iron		Nodular cast iron	Malleable cast iron			
VDI 3323	1	2	3	4	5	6	7	8	9	10	11	12	13	14	15	16	17	18	19	20	
HRc		13	25	28	32	10	29	32	38	15	35	15	23	10	10	26	3	25		21	
HB	125	190	250	270	300	180	275	300	350	200	325	200	240	180	180	260	160	250	130	230	
Recommend	◎	◎	◎	◎	◎	◎	◎	◎	◎	◎	◎	○	○	○	○	○	○	○	○	○	
ISO Material Description	N										S					H					
	Aluminum-wrought alloy		Aluminum-cast, alloyed			Copper and Copper Alloys (Bronze / Brass)			Non Metallic Materials		Heat Resistant Super Alloys					Titanium Alloys		Hardened steel	Chilled Cast Iron	Hardened Cast Iron	
VDI 3323	21	22	23	24	25	26	27	28	29	30	31	32	33	34	35	36	37	38	39	40	41
HRc											15	30	25	38	34			55	60	42	55
HB	60	100	75	90	130	110	90	100			200	280	250	350	320	400 Rm	1050 Rm	550	630	400	550
Recommend	○	○	○	○	○	○	○	○	○	○	○	○	○	○	○	○	○	○	○	○	○

CARBIDE, 3 FLUTE SHORT LENGTH WITH CHAMFER

- VOLLHARTMETALL, 3 SCHNEIDEN KURZ
- ! Fraise carbure, 3 dents, courte
- ! 3 TAGLIANTI, SERIE CORTA

- ▶ Suitable for dry milling applications at high temperatures.
- ▶ Excellent high-performance end mills.
- ▶ 3 flute design possesses the advantage of 2 flute and 4 flute end mill.
- ▶ Für die Trockenbearbeitung.
- ▶ Hervorragendes Preis - Leistungsverhältnis.
- ▶ 3 Schneiden verbinden die Vorteile von 2 - und 4 - schneidigen Schafffräsern.

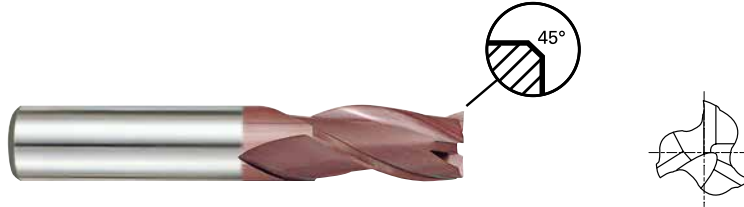

Unit : mm

EDP No.	Mill Diameter	Shank Diameter	Length of Cut	Overall Length	Chamfer
G9G47030	3.0	3	12	32	0.1
G9G47040	4.0	4	12	40	0.1
G9G47050	5.0	5	14	50	0.1
G9G47060	6.0	6	16	50	0.1
G9G47080	8.0	8	20	60	0.13
G9G47100	10.0	10	22	70	0.13
G9G47120	12.0	12	22	70	0.18
G9G47140	14.0	14	25	75	0.18
G9G47160	16.0	16	25	75	0.18
G9G47200	20.0	20	32	100	0.23

Mill Dia. Tolerance(mm)	Shank Dia. Tolerance
0 ~ -0.03	h5

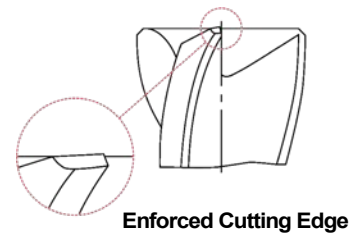

◎ : Excellent ○ : Good

ISO Material Description	P										M				K						
	Non-alloy steel					Low alloy steel					High alloyed steel, and tool steel				Stainless steel		Grey cast iron		Nodular cast iron		Malleable cast iron
VDI 3323	1	2	3	4	5	6	7	8	9	10	11	12	13	14	15	16	17	18	19	20	
HRC	13	25	28	32	10	29	32	38	15	35	15	23	10	15	16	3	25	19	21		
HB	125	190	250	270	300	180	275	300	350	200	325	200	240	180	180	260	160	250	130	230	
Recommend	◎	◎	◎	◎	◎	◎	◎	◎	◎	◎	◎	○	○	○	○	○	○	○	○	○	
ISO Material Description	N										S						H				
	Aluminum-wrought alloy		Aluminum-cast, alloyed			Copper and Copper Alloys (Bronze / Brass)			Non Metallic Materials		Heat Resistant Super Alloys						Titanium Alloys		Hardened steel	Chilled Cast Iron	Hardened Cast Iron
VDI 3323	21	22	23	24	25	26	27	28	29	30	31	32	33	34	35	36	37	38	39	40	41
HRC	60	100	75	90	130	110	90	100			15	30	25	38	34	400 Rm	1050 Rm	55	60	42	55
HB	60	100	75	90	130	110	90	100			200	280	250	350	320	400 Rm	1050 Rm	550	630	400	550
Recommend	○	○	○	○	○	○	○	○	○	○	○	○	○	○	○	○	○	○	○	○	○

CARBIDE, 3 FLUTE SHORT LENGTH

- **VOLLHARTMETALL, 3 SCHNEIDEN KURZ**
- **Fraise carbure, 3 dents, courte**
- **3 TAGLIENTI, SERIE CORTA**

- ▶ Suitable for dry milling applications at high temperatures.
- ▶ Excellent high-performance end mills.
- ▶ 3 flute design possesses the advantage of 2 flute and 4 flute end mill.
- ▶ Für die Trockenbearbeitung.
- ▶ Hervorragendes Preis - Leistungsverhältnis.
- ▶ 3 Schneiden verbinden die Vorteile von 2 - und 4 - schneidigen Schaffräsern.

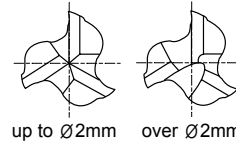

CARBIDE
DIN 6527
3
≈ 30°
DIN 6535HB
P.606-607

Unit : mm

EDP No.	Mill Diameter	Shank Diameter	Length of Cut	Overall Length
G9439020	2.0	6	3	50
G9439030	3.0	6	4	50
G9439035	3.5	6	4	50
G9439040	4.0	6	5	54
G9439045	4.5	6	5	54
G9439050	5.0	6	6	54
G9439060	6.0	6	7	54
G9439070	7.0	8	8	58
G9439080	8.0	8	9	58
G9439090	9.0	10	10	66
G9439100	10.0	10	11	66
G9439120	12.0	12	12	73
G9439140	14.0	14	14	75
G9439160	16.0	16	16	82
G9439180	18.0	18	18	84
G9439200	20.0	20	20	92

Mill Dia. Tolerance(mm)	Shank Dia. Tolerance
0 ~ - 0.03	h5

◎ : Excellent ○ : Good

ISO Material Description	P											M				K								
	Non-alloy steel					Low alloy steel						High alloyed steel, and tool steel				Stainless steel				Grey cast iron		Nodular cast iron		Malleable cast iron
VDI 3323	1	2	3	4	5	6	7	8	9	10	11	12	13	14	15	16	17	18	19	20				
HRc		13	25	28	32	10	29	32	38	15	35	15	23	10	10	26	3	25		21				
HB	125	190	250	270	300	180	275	300	350	200	325	200	240	180	180	260	160	250	130	230				
Recommend	◎	◎	◎	◎	◎	◎	◎	◎	◎	◎	◎	◎	◎	◎	◎	◎	◎	◎	◎	◎				
ISO Material Description	N										S							H						
	Aluminum-wrought alloy		Aluminum-cast, alloyed			Copper and Copper Alloys (Bronze / Brass)			Non Metallic Materials		Heat Resistant Super Alloys							Titanium Alloys		Hardened steel	Chilled Cast Iron	Hardened Cast Iron		
VDI 3323	21	22	23	24	25	26	27	28	29	30	31	32	33	34	35	36	37	38	39	40	41			
HRc											15	30	25	38	34			55	60	42	55			
HB	60	100	75	90	130	110	90	100			200	280	250	350	320	400 Rm	1050 Rm	550	630	400	550			
Recommend	◎	◎	◎	◎	◎	◎	◎	◎	◎	◎	◎	◎	◎	◎	◎	◎	◎	◎	◎	◎	◎			

CARBIDE, 3 FLUTE LONG LENGTH

- VOLLHARTMETALL, 3 SCHNEIDEN LANG
- 🇫🇷 Fraise carbure, 3 dents, longue
- 🇮🇹 3 TAGLIANTI, SERIE LUNGA

- ▶ Suitable for dry milling applications at high temperatures.
- ▶ Excellent high-performance end mills.
- ▶ 3 flute design possesses the advantage of 2 flute and 4 flute end mill.

- ▶ Für die Trockenbearbeitung.
- ▶ Hervorragendes Preis - Leistungsverhältnis.
- ▶ 3 Schneiden verbinden die Vorteile von 2 - und 4 - schneidigen Schaffräsern.

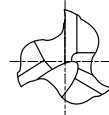

CARBIDE
DIN 6528
3
30°
DIN 6535HA
P.606-607

Unit : mm

EDP No.	Mill Diameter	Shank Diameter	Length of Cut	Overall Length
G9528035	3.5	3.5	7	50
G9528040	4.0	4	8	50
G9528045	4.5	4.5	8	50
G9528050	5.0	5	10	50
G9528055	5.5	5.5	10	57
G9528060	6.0	6	10	57
G9528065	6.5	6.5	13	60
G9528070	7.0	7	13	60
G9528075	7.5	7.5	16	63
G9528080	8.0	8	16	63
G9528085	8.5	8.5	16	67
G9528090	9.0	9	16	67
G9528095	9.5	9.5	19	72
G9528100	10.0	10	19	72
G9528110	11.0	11	22	83
G9528120	12.0	12	22	83
G9528130	13.0	13	22	83
G9528140	14.0	14	22	83
G9528150	15.0	15	26	92
G9528160	16.0	16	26	92
G9528180	18.0	18	26	92
G9528200	20.0	20	32	104

Mill Dia. Tolerance(mm)	Shank Dia. Tolerance
0 ~ - 0.03	h5

◎ : Excellent ○ : Good

ISO Material Description	P										M				K						
	Non-alloy steel					Low alloy steel					High alloyed steel, and tool steel				Stainless steel		Grey cast iron		Nodular cast iron		Malleable cast iron
VDI 3323	1	2	3	4	5	6	7	8	9	10	11	12	13	14	15	16	17	18	19	20	
HRC		13	25	28	32	10	29	32	38	15	35	15	23	10	10	26	3	25	42	21	
HB	125	190	250	270	300	180	275	300	350	200	325	200	240	180	180	260	160	250	130	230	
Recommend	◎	◎	◎	◎	◎	◎	◎	◎	◎	◎	◎	○	○	○	○	○	○	○	○	○	

ISO Material Description	N										S						H				
	Aluminum-wrought alloy		Aluminum-cast, alloyed			Copper and Copper Alloys (Bronze / Brass)			Non Metallic Materials		Heat Resistant Super Alloys						Titanium Alloys		Hardened steel	Chilled Cast Iron	Hardened Cast Iron
VDI 3323	21	22	23	24	25	26	27	28	29	30	31	32	33	34	35	36	37	38	39	40	41
HRC											15	30	25	38	34			55	60	42	55
HB	60	100	75	90	130	110	90	100			200	280	250	350	320	400 Rm	1050 Rm	550	630	400	550
Recommend	○	○	○	○	○	○	○	○	○	○	○	○	○	○	○	○	○	○	○	○	○

CARBIDE, 3 FLUTE LONG LENGTH

- **VOLLHARTMETALL, 3 SCHNEIDEN LANG**
- **Fraise carbure, 3 dents, longue**
- **3 TAGLIENTI, SERIE LUNGA**

- ▶ Suitable for dry milling applications at high temperatures.
- ▶ Excellent high-performance end mills.
- ▶ 3 flute design possesses the advantage of 2 flute and 4 flute end mill.
- ▶ Für die Trockenbearbeitung.
- ▶ Hervorragendes Preis - Leistungsverhältnis.
- ▶ 3 Schneiden verbinden die Vorteile von 2 - und 4 - schneidigen Schafffräsern.

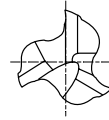

CARBIDE
DIN 6527
3
≈ 30°
DIN 6535HB
P.606-607

Unit : mm

EDP No.	Mill Diameter	Shank Diameter	Length of Cut	Overall Length
G9433030	3.0	6	7	57
G9433040	4.0	6	8	57
G9433050	5.0	6	10	57
G9433060	6.0	6	10	57
G9433080	8.0	8	16	63
G9433090	9.0	10	16	72
G9433100	10.0	10	19	72
G9433120	12.0	12	22	83
G9433140	14.0	14	22	83
G9433160	16.0	16	26	92
G9433180	18.0	18	26	92
G9433200	20.0	20	32	104

Mill Dia. Tolerance(mm)	Shank Dia. Tolerance
0 ~ - 0.03	h5

◎ : Excellent ○ : Good

ISO Material Description	P											M			K						
	Non-alloy steel					Low alloy steel						High alloyed steel, and tool steel			Stainless steel			Grey cast iron		Nodular cast iron	
VDI 3323	1	2	3	4	5	6	7	8	9	10	11	12	13	14	15	16	17	18	19	20	
HRc	13	25	28	32	10	29	32	38	15	35	15	23	10	10	26	3	25		21		
HB	125	190	250	270	300	180	275	300	350	200	325	200	240	180	180	260	160	250	130	230	
Recommend	◎	◎	◎	◎	◎	◎	◎	◎	◎	◎	◎	◎	◎	◎	◎	◎	◎	◎	◎	◎	
ISO Material Description	N										S							H			
	Aluminum-wrought alloy		Aluminum-cast, alloyed			Copper and Copper Alloys (Bronze / Brass)			Non Metallic Materials		Heat Resistant Super Alloys							Titanium Alloys		Hardened steel	Chilled Cast Iron
VDI 3323	21	22	23	24	25	26	27	28	29	30	31	32	33	34	35	36	37	38	39	40	41
HRc											15	30	25	38	34			55	60	42	55
HB	60	100	75	90	130	110	90	100			200	280	250	350	320	400 Rm	1050 Rm	550	630	400	550
Recommend	◎	◎	◎	◎	◎	◎	◎	◎	◎	◎	◎	◎	◎	◎	◎	◎	◎	◎	◎	◎	◎

CARBIDE, 3 FLUTE LONG LENGTH WITH CHAMFER

- VOLLHARTMETALL, 3 SCHNEIDEN LANG
- Fraise carbure, 3 dents, longue
- 3 TAGLIANTI, SERIE LUNGA

- ▶ Suitable for dry milling applications at high temperatures.
- ▶ Excellent high-performance end mills.
- ▶ 3 flute design possesses the advantage of 2 flute and 4 flute end mill.

- ▶ Für die Trockenbearbeitung.
- ▶ Hervorragendes Preis - Leistungsverhältnis.
- ▶ 3 Schneiden verbinden die Vorteile von 2 - und 4 - schneidigen Schafffräsern.



Unit : mm

EDP No.	Mill Diameter	Shank Diameter	Length of Cut	Overall Length	Chamfer
G9G48030	3.0	6	7	57	0.10
G9G48040	4.0	6	8	57	0.10
G9G48050	5.0	6	10	57	0.10
G9G48060	6.0	6	10	57	0.10
G9G48080	8.0	8	16	63	0.13
G9G48100	10.0	10	19	72	0.13
G9G48120	12.0	12	22	83	0.18
G9G48140	14.0	14	22	83	0.18
G9G48160	16.0	16	26	92	0.18
G9G48200	20.0	20	32	104	0.23

Mill Dia. Tolerance(mm)	Shank Dia. Tolerance
0 ~ -0.03	h5

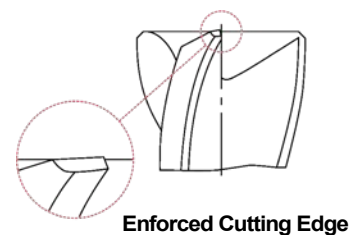

◎ : Excellent ○ : Good

ISO Material Description	P										M				K						
	Non-alloy steel					Low alloy steel					High alloyed steel, and tool steel				Stainless steel		Grey cast iron		Nodular cast iron		Malleable cast iron
VDI 3323	1	2	3	4	5	6	7	8	9	10	11	12	13	14	15	16	17	18	19	20	
HRC	13	25	28	32	10	29	32	38	15	11	15	23	10	10	26	3	25	13	21		
HB	125	190	250	270	300	180	275	300	350	200	325	200	240	180	180	260	160	250	130	230	
Recommend	◎	◎	◎	◎	◎	◎	◎	◎	◎	◎	◎	○	○	○	○	○	○	○	○	○	

ISO Material Description	N					S										H					
	Aluminum-wrought alloy		Aluminum-cast, alloyed			Copper and Copper Alloys (Bronze / Brass)			Non Metallic Materials		Heat Resistant Super Alloys					Titanium Alloys		Hardened steel	Chilled Cast Iron	Hardened Cast Iron	
VDI 3323	21	22	23	24	25	26	27	28	29	30	31	32	33	34	35	36	37	38	39	40	41
HRC	60	100	75	90	130	110	90	100			15	30	25	38	34	400 Rm	1050 Rm	55	60	42	55
HB	60	100	75	90	130	110	90	100			200	280	250	350	320	400 Rm	1050 Rm	550	630	400	550
Recommend	○	○	○	○	○	○	○	○	○	○	○	○	○	○	○	○	○	○	○	○	○

CARBIDE, 3 FLUTE 45° HELIX, LONG LENGTH

● **VOLLHARTMETALL, 3 SCHNEIDEN 45° RECHTSSPIRALE LANG**
 ● **Fraise carbure, 3 dents, hélice 45°, longue**
 ● **3 TAGLIENTI, ELICA 45°, SERIE LUNGA**

▶ Suitable for dry milling applications at high temperatures.
 ▶ Excellent high-performance end mills.

▶ Für die Trockenbearbeitung.
 ▶ Hervorragendes Preis - Leistungsverhältnis.

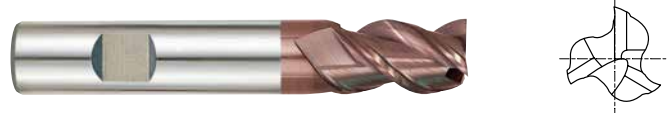

CARBIDE DIN 6527 3 45° DIN 6535HB P.606-607

Unit : mm

EDP No.	Mill Diameter	Shank Diameter	Length of Cut	Overall Length
G9447030	3.0	6	7	57
G9447035	3.5	6	7	57
G9447040	4.0	6	8	57
G9447045	4.5	6	8	57
G9447050	5.0	6	10	57
G9447060	6.0	6	10	57
G9447070	7.0	8	13	63
G9447080	8.0	8	16	63
G9447090	9.0	10	16	72
G9447100	10.0	10	19	72
G9447120	12.0	12	22	83
G9447140	14.0	14	22	83
G9447160	16.0	16	26	92
G9447180	18.0	18	26	92
G9447200	20.0	20	32	104

Mill Dia. Tolerance(mm)	Shank Dia. Tolerance
0 ~ - 0.03	h5

◎ : Excellent ○ : Good

ISO Material Description	P											M				K					
	Non-alloy steel					Low alloy steel				High alloyed steel, and tool steel		Stainless steel		Grey cast iron		Nodular cast iron		Malleable cast iron			
VDI 3323	1	2	3	4	5	6	7	8	9	10	11	12	13	14	15	16	17	18	19	20	
HRc	13	25	28	32	10	29	32	38	15	35	15	23	10	10	26	3	25	42	55		
HB	125	190	250	270	300	180	275	300	350	200	325	200	240	180	180	260	160	250	130	230	
Recommend	◎	◎	◎	◎	◎	◎	◎	◎	◎	◎	◎	○	○	○	○	○	○	○	○	○	
ISO Material Description	N										S						H				
	Aluminum-wrought alloy		Aluminum-cast, alloyed			Copper and Copper Alloys (Bronze / Brass)			Non Metallic Materials		Heat Resistant Super Alloys				Titanium Alloys		Hardened steel	Chilled Cast Iron	Hardened Cast Iron		
VDI 3323	21	22	23	24	25	26	27	28	29	30	31	32	33	34	35	36	37	38	39	40	41
HRc	21	22	23	24	25	26	27	28	29	30	15	30	25	38	34	34	34	55	60	42	55
HB	60	100	75	90	130	110	90	100			200	280	250	350	320	400 Rm	1050 Rm	550	630	400	550
Recommend	○	○	○	○	○	○	○	○	○	○	○	○	○	○	○	○	○	○	○	○	○

CARBIDE, 3 FLUTE 45° HELIX, LONG LENGTH WITH CHAMFER

- VOLLHARTMETALL, 3 SCHNEIDEN 45° RECHTSSPIRALE LANG
- Fraise carbure, 3 dents, hélice 45°, longue
- 3 TAGLIANTI, ELICA 45°, SERIE LUNGA

- ▶ Suitable for dry milling applications at high temperatures.
- ▶ Excellent high-performance end mills.
- ▶ Für die Trockenbearbeitung.
- ▶ Hervorragendes Preis - Leistungsverhältnis.

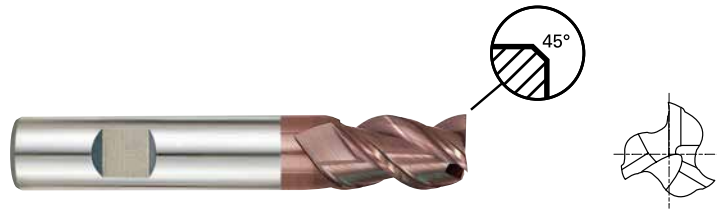

CARBIDE DIN 6527 3 45° DIN 6535HB C x 45° P.606-607

Unit : mm

EDP No.	Mill Diameter	Shank Diameter	Length of Cut	Overall Length	Chamfer
G9G49030	3.0	6	7	57	0.10
G9G49040	4.0	6	8	57	0.10
G9G49050	5.0	6	10	57	0.10
G9G49060	6.0	6	10	57	0.10
G9G49080	8.0	8	16	63	0.13
G9G49100	10.0	10	19	72	0.13
G9G49120	12.0	12	22	83	0.18
G9G49140	14.0	14	22	83	0.18
G9G49160	16.0	16	26	92	0.18
G9G49200	20.0	20	32	104	0.23

Mill Dia. Tolerance(mm)	Shank Dia. Tolerance
0 ~ -0.03	h5

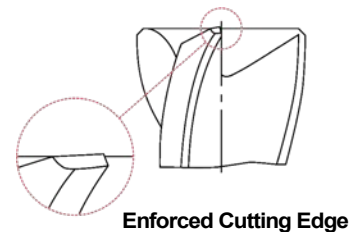

◎ : Excellent ○ : Good

ISO Material Description	P										M				K						
	Non-alloy steel					Low alloy steel					High alloyed steel, and tool steel				Stainless steel		Grey cast iron		Nodular cast iron		Malleable cast iron
VDI 3323	1	2	3	4	5	6	7	8	9	10	11	12	13	14	15	16	17	18	19	20	
HRC	13	25	28	32	10	29	32	38	15	35	15	23	10	10	26	3	25	42	21		
HB	125	190	250	270	300	180	275	300	350	200	325	200	240	180	180	260	160	250	130	230	
Recommend	◎	◎	◎	◎	◎	◎	◎	◎	◎	◎	◎	○	○	○	○	○	○	○	○	○	
ISO Material Description	N										S						H				
	Aluminum-wrought alloy		Aluminum-cast, alloyed			Copper and Copper Alloys (Bronze / Brass)			Non Metallic Materials		Heat Resistant Super Alloys						Titanium Alloys		Hardened steel	Chilled Cast Iron	Hardened Cast Iron
VDI 3323	21	22	23	24	25	26	27	28	29	30	31	32	33	34	35	36	37	38	39	40	41
HRC	60	100	75	90	130	110	90	100			15	30	25	38	34	400 Rm	1050 Rm	55	60	42	55
HB	60	100	75	90	130	110	90	100			200	280	250	350	320	400 Rm	1050 Rm	550	630	400	550
Recommend	○	○	○	○	○	○	○	○	○	○	○	○	○	○	○	○	○	○	○	○	○

CARBIDE, 4 FLUTE SHORT LENGTH

- **VOLLHARTMETALL, 4 SCHNEIDEN KURZ**
- **Fraise carbure, 4 dents, courte**
- **4 TAGLIENTI, CORTA**

- ▶ Suitable for dry milling applications at high temperatures.
- ▶ Excellent high-performance end mills.
- ▶ 4 flute allows for better work piece finishes.

- ▶ Für die Trockenbearbeitung.
- ▶ Hervorragendes Preis - Leistungsverhältnis.
- ▶ 4 Schneiden erzeugen eine bessere Oberflächengüte des Werkstücks.

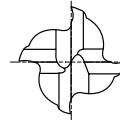

Unit : mm

EDP No.	Mill Diameter	Shank Diameter	Length of Cut	Overall Length
G9432010	1.0	4	3	40
G9432015	1.5	4	4.5	40
G9432020	2.0	2	8	32
G9432025	2.5	2.5	8	32
G9432030	3.0	3	12	32
G9432035	3.5	3.5	12	32
G9432040	4.0	4	12	40
G9432045	4.5	4.5	14	50
G9432050	5.0	5	14	50
G9432055	5.5	5.5	16	50
G9432060	6.0	6	16	50
G9432070	7.0	7	20	60
G9432080	8.0	8	20	60
G9432090	9.0	9	20	60
G9432100	10.0	10	22	70
G9432120	12.0	12	22	70
G9432140	14.0	14	25	75
G9432160	16.0	16	25	75
G9432200	20.0	20	32	100

Mill Dia. Tolerance(mm)	Shank Dia. Tolerance
0 ~ - 0.03	h5

◎ : Excellent ○ : Good

ISO Material Description	P											M				K								
	Non-alloy steel					Low alloy steel						High alloyed steel, and tool steel				Stainless steel				Grey cast iron		Nodular cast iron		Malleable cast iron
VDI 3323	1	2	3	4	5	6	7	8	9	10	11	12	13	14	15	16	17	18	19	20				
HRc		13	25	28	32	10	29	32	38	15	35	15	23	10	10	26	3	25		21				
HB	125	190	250	270	300	180	275	300	350	200	325	200	240	180	180	260	160	250	130	230				
Recommend	◎	◎	◎	◎	◎	◎	◎	◎	◎	◎	◎	◎	◎	◎	◎	◎	◎	◎	◎	◎				
ISO Material Description	N										S							H						
	Aluminum-wrought alloy		Aluminum-cast, alloyed			Copper and Copper Alloys (Bronze / Brass)			Non Metallic Materials		Heat Resistant Super Alloys							Titanium Alloys		Hardened steel	Chilled Cast Iron	Hardened Cast Iron		
VDI 3323	21	22	23	24	25	26	27	28	29	30	31	32	33	34	35	36	37	38	39	40	41			
HRc											15	30	25	38	34			55	60	42	55			
HB	60	100	75	90	130	110	90	100			200	280	250	350	320	400 Rm	1050 Rm	550	630	400	550			
Recommend	◎	◎	◎	◎	◎	◎	◎	◎	◎	◎	◎	◎	◎	◎	◎	◎	◎	◎	◎	◎	◎			

CARBIDE, 4 FLUTE SHORT LENGTH WITH CHAMFER

- VOLLHARTMETALL, 4 SCHNEIDEN KURZ
- ⊖ Fraise carbure, 4 dents, courte
- ⊖ 4 TAGLIANTI, CORTA

- ▶ Suitable for dry milling applications at high temperatures.
- ▶ Excellent high-performance end mills.
- ▶ 4 flute allows for better work piece finishes.

- ▶ Für die Trockenbearbeitung.
- ▶ Hervorragendes Preis - Leistungsverhältnis.
- ▶ 4 Schneiden erzeugen eine bessere Oberflächengüte des Werkstücks.

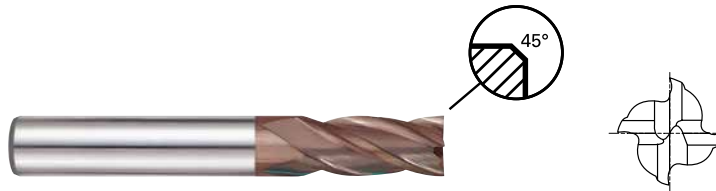

Unit : mm

EDP No.	Mill Diameter	Shank Diameter	Length of Cut	Overall Length	Chamfer
G9G50030	3.0	3	12	32	0.10
G9G50040	4.0	4	12	40	0.10
G9G50050	5.0	5	14	50	0.10
G9G50060	6.0	6	16	50	0.10
G9G50080	8.0	8	20	60	0.13
G9G50100	10.0	10	22	70	0.13
G9G50120	12.0	12	22	70	0.18
G9G50140	14.0	14	25	75	0.18
G9G50160	16.0	16	25	75	0.18
G9G50200	20.0	20	32	100	0.23

Mill Dia. Tolerance(mm)	Shank Dia. Tolerance
0 ~ -0.03	h5

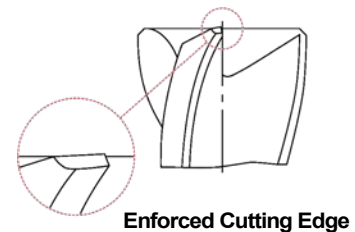
Enforced Cutting Edge

◎ : Excellent ○ : Good

ISO Material Description	P										M				K						
	Non-alloy steel					Low alloy steel					High alloyed steel, and tool steel				Stainless steel		Grey cast iron		Nodular cast iron		Malleable cast iron
VDI 3323	1	2	3	4	5	6	7	8	9	10	11	12	13	14	15	16	17	18	19	20	
HRC	125	130	25	28	32	10	29	32	38	15	35	15	23	10	10	26	3	25	42	21	
HB	125	190	250	270	300	180	275	300	350	200	325	200	240	180	180	260	160	250	130	230	
Recommend	◎	◎	◎	◎	◎	◎	◎	◎	◎	◎	◎	○	○	○	○	○	○	○	○	○	
ISO Material Description	N										S						H				
	Aluminum-wrought alloy		Aluminum-cast, alloyed			Copper and Copper Alloys (Bronze / Brass)			Non Metallic Materials		Heat Resistant Super Alloys						Titanium Alloys		Hardened steel	Chilled Cast Iron	Hardened Cast Iron
VDI 3323	21	22	23	24	25	26	27	28	29	30	31	32	33	34	35	36	37	38	39	40	41
HRC	60	100	75	90	130	110	90	100			15	30	25	38	34	400 Rm	1050 Rm	550	630	400	550
HB	60	100	75	90	130	110	90	100			200	280	250	350	320	400 Rm	1050 Rm	550	630	400	550
Recommend	○	○	○	○	○	○	○	○	○	○	○	○	○	○	○	○	○	○	○	○	○

CARBIDE, 4 FLUTE SHORT LENGTH

- **VOLLHARTMETALL, 4 SCHNEIDEN KURZ**
- **Fraise carbure, 4 dents, courte**
- **4 TAGLIENTI, CORTA**

- ▶ Suitable for dry milling applications at high temperatures.
- ▶ Excellent high-performance end mills.
- ▶ 4 flute allows for better work piece finishes.

- ▶ Für die Trockenbearbeitung.
- ▶ Hervorragendes Preis - Leistungsverhältnis.
- ▶ 4 Schneiden erzeugen eine bessere Oberflächengüte des Werkstücks.

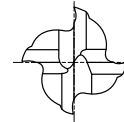

CARBIDE
4
30°
DIN 6535HA
P.608

Unit : mm

EDP No.	Mill Diameter	Shank Diameter	Length of Cut	Overall Length
G9A69010	1.0	3	3	39
G9A69015	1.5	3	5	39
G9A69020	2.0	3	7	39
G9A69025	2.5	3	7	39
G9A69030	3.0	3	10	39
G9A69040	4.0	4	14	51
G9A69050	5.0	5	16	51
G9A69060	6.0	6	19	64
G9A69080	8.0	8	21	64
G9A69100	10.0	10	22	70
G9A69120	12.0	12	25	76
G9A69160	16.0	16	32	89
G9A69200	20.0	20	38	102

Mill Dia. Tolerance(mm)	Shank Dia. Tolerance
0 ~ - 0.03	h5

◎ : Excellent ○ : Good

ISO Material Description	P											M				K						
	Non-alloy steel					Low alloy steel						High alloyed steel, and tool steel				Stainless steel		Grey cast iron		Nodular cast iron		Malleable cast iron
VDI 3323	1	2	3	4	5	6	7	8	9	10	11	12	13	14	15	16	17	18	19	20		
HRc		13	25	28	32	10	29	32	38	15	35	15	23	10	10	26	3	25		21		
HB	125	190	250	270	300	180	275	300	350	200	325	200	240	180	180	260	160	250	130	230		
Recommend	◎	◎	◎	◎	◎	◎	◎	◎	◎	◎	◎	○	○	○	○	○	○	○	○	○		
ISO Material Description	N										S							H				
	Aluminum-wrought alloy		Aluminum-cast, alloyed			Copper and Copper Alloys (Bronze / Brass)			Non Metallic		Heat Resistant Super Alloys							Titanium Alloys		Hardened steel	Chilled Cast Iron	Hardened Cast Iron
VDI 3323	21	22	23	24	25	26	27	28	29	30	31	32	33	34	35	36	37	38	39	40	41	
HRc											15	30	25	38	34			55	60	42	55	
HB	60	100	75	90	130	110	90	100			200	280	250	350	320	400 Rm	1050 Rm	550	630	400	550	
Recommend	○	○	○	○	○	○	○	○	○	○	○	○	○	○	○	○	○	○	○	○	○	

CARBIDE, 4 FLUTE SHORT LENGTH

- VOLLHARTMETALL, 4 SCHNEIDEN KURZ
- Fraise carbure, 4 dents, courte
- 4 TAGLIANTI, SERIE CORTA

- ▶ Suitable for dry milling applications at high temperatures.
- ▶ Excellent high-performance end mills.
- ▶ 4 flute allows for better work piece finishes.
- ▶ Für die Trockenbearbeitung.
- ▶ Hervorragendes Preis - Leistungsverhältnis.
- ▶ 4 Schneiden erzeugen eine bessere Oberflächengüte des Werkstücks.

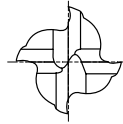

CARBIDE DIN 6527 4 $\approx 30^\circ$ DIN 6535HB P.608

Unit : mm

EDP No.	Mill Diameter	Shank Diameter	Length of Cut	Overall Length
G9448020	2.0	6	4	50
G9448025	2.5	6	4	50
G9448030	3.0	6	5	50
G9448035	3.5	6	6	50
G9448040	4.0	6	8	54
G9448045	4.5	6	8	54
G9448050	5.0	6	9	54
G9448060	6.0	6	10	54
G9448070	7.0	8	11	58
G9448080	8.0	8	12	58
G9448090	9.0	10	13	66
G9448100	10.0	10	14	66
G9448120	12.0	12	16	73
G9448140	14.0	14	18	75
G9448160	16.0	16	22	82
G9448180	18.0	18	24	84
G9448200	20.0	20	26	92

Mill Dia. Tolerance(mm)	Shank Dia. Tolerance
0 ~ -0.03	h5

◎ : Excellent ○ : Good

ISO Material Description	P										M				K						
	Non-alloy steel					Low alloy steel					High alloyed steel, and tool steel				Stainless steel		Grey cast iron		Nodular cast iron		Malleable cast iron
VDI 3323	1	2	3	4	5	6	7	8	9	10	11	12	13	14	15	16	17	18	19	20	
HRc	13	25	28	32	10	29	32	38	15	11	15	23	10	10	26	3	25	3	21		
HB	125	190	250	270	300	180	275	300	350	200	325	200	240	180	180	260	160	250	130	230	
Recommend	◎	◎	◎	◎	◎	◎	◎	◎	◎	◎	◎	◎	◎	◎	◎	◎	◎	◎	◎	◎	

ISO Material Description	N					S										H					
	Aluminum-wrought alloy		Aluminum-cast, alloyed			Copper and Copper Alloys (Bronze / Brass)			Non Metallic Materials		Heat Resistant Super Alloys					Titanium Alloys		Hardened steel	Chilled Cast Iron	Hardened Cast Iron	
VDI 3323	21	22	23	24	25	26	27	28	29	30	31	32	33	34	35	36	37	38	39	40	41
HRc	60	100	75	90	130	110	90	100			200	280	250	350	320	400 Rm	1050 Rm	550	630	400	550
Recommend	◎	◎	◎	◎	◎	◎	◎	◎	◎	◎	◎	◎	◎	◎	◎	◎	◎	◎	◎	◎	◎

CARBIDE, 4 FLUTE LONG LENGTH

- **VOLLHARTMETALL, 4 SCHNEIDEN LANG**
- **Fraise carbure, 4 dents, longue**
- **4 TAGLIENTI, SERIE LUNGA**

- ▶ Suitable for dry milling applications at high temperatures.
- ▶ Excellent high-performance end mills.
- ▶ 4 flute allows for better work piece finishes.

- ▶ Für die Trockenbearbeitung.
- ▶ Hervorragendes Preis - Leistungsverhältnis.
- ▶ 4 Schneiden erzeugen eine bessere Oberflächengüte des Werkstücks.

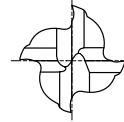

CARBIDE
DIN 6528
4
≈ 30°
DIN 6535HA
P.608

Unit : mm

EDP No.	Mill Diameter	Shank Diameter	Length of Cut	Overall Length
G9540035	3.5	3.5	10	50
G9540040	4.0	4	11	50
G9540045	4.5	4.5	11	50
G9540050	5.0	5	13	50
G9540055	5.5	5.5	13	57
G9540060	6.0	6	13	57
G9540065	6.5	6.5	16	60
G9540070	7.0	7	16	60
G9540075	7.5	7.5	19	63
G9540080	8.0	8	19	63
G9540085	8.5	8.5	19	67
G9540090	9.0	9	19	67
G9540095	9.5	9.5	22	72
G9540100	10.0	10	22	72
G9540110	11.0	11	26	83
G9540120	12.0	12	26	83
G9540130	13.0	13	26	83
G9540140	14.0	14	26	83
G9540150	15.0	15	32	92
G9540160	16.0	16	32	92
G9540180	18.0	18	32	92
G9540200	20.0	20	38	104

Mill Dia. Tolerance(mm)	Shank Dia. Tolerance
0 ~ - 0.03	h5

◎ : Excellent ○ : Good

ISO Material Description	P											M			K						
	Non-alloy steel					Low alloy steel				High alloyed steel, and tool steel		Stainless steel			Grey cast iron		Nodular cast iron		Malleable cast iron		
VDI 3323	1	2	3	4	5	6	7	8	9	10	11	12	13	14	15	16	17	18	19	20	
HRc		13	25	28	32	10	29	32	38	15	35	15	23	10	10	26	3	25		21	
HB	125	190	250	270	300	180	275	300	350	200	325	200	240	180	180	260	160	250	130	230	
Recommend	◎	◎	◎	◎	◎	◎	◎	◎	◎	◎	◎	○	○	○	○	○	○	○	○	○	
ISO Material Description	N										S						H				
	Aluminum-wrought alloy		Aluminum-cast, alloyed			Copper and Copper Alloys (Bronze / Brass)			Non Metallic Materials		Heat Resistant Super Alloys						Titanium Alloys		Hardened steel	Chilled Cast Iron	Hardened Cast Iron
VDI 3323	21	22	23	24	25	26	27	28	29	30	31	32	33	34	35	36	37	38	39	40	41
HRc											15	30	25	38	34			55	60	42	55
HB	60	100	75	90	130	110	90	100			200	280	250	350	320	400 Rm	1050 Rm	550	630	400	550
Recommend	○	○	○	○	○	○	○	○	○	○	○	○	○	○	○	○	○	○	○	○	○

CARBIDE, 4 FLUTE LONG LENGTH

- VOLLHARTMETALL, 4 SCHNEIDEN LANG
- ⊖ Fraise carbure, 4 dents, longue
- ⊖ 4 TAGLIANTI, SERIE LUNGA

- ▶ Suitable for dry milling applications at high temperatures.
- ▶ Excellent high-performance end mills.
- ▶ 4 flute allows for better work piece finishes.

- ▶ Für die Trockenbearbeitung.
- ▶ Hervorragendes Preis - Leistungsverhältnis.
- ▶ 4 Schneiden erzeugen eine bessere Oberflächengüte des Werkstücks.

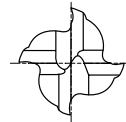

Unit : mm

EDP No.	Mill Diameter	Shank Diameter	Length of Cut	Overall Length
G9449901	2.0	● 3	7	38
G9449030	3.0	6	8	57
G9449035	3.5	6	10	57
G9449040	4.0	6	11	57
G9449045	4.5	6	11	57
G9449050	5.0	6	13	57
G9449060	6.0	6	13	57
G9449070	7.0	8	16	63
G9449080	8.0	8	19	63
G9449090	9.0	10	19	72
G9449100	10.0	10	22	72
G9449120	12.0	12	26	83
G9449140	14.0	14	26	83
G9449160	16.0	16	32	92
G9449180	18.0	18	32	92
G9449200	20.0	20	38	104

● with plain shank

Mill Dia. Tolerance(mm)	Shank Dia. Tolerance
0 ~ - 0.03	h5

◎ : Excellent ○ : Good

ISO Material Description	P										M				K						
	Non-alloy steel					Low alloy steel					High alloyed steel, and tool steel				Stainless steel		Grey cast iron		Nodular cast iron		Malleable cast iron
VDI 3323	1	2	3	4	5	6	7	8	9	10	11	12	13	14	15	16	17	18	19	20	
HRc	13	25	28	32	10	29	32	38	15	35	15	23	10	10	26	3	25	3	21		
HB	125	190	250	270	300	180	275	300	350	200	325	200	240	180	180	260	160	250	130	230	
Recommend	◎	◎	◎	◎	◎	◎	◎	◎	◎	◎	◎	○	○	○	○	○	○	○	○	○	

ISO Material Description	N					S										H					
	Aluminum-wrought alloy		Aluminum-cast, alloyed			Copper and Copper Alloys (Bronze / Brass)			Non Metallic Materials		Heat Resistant Super Alloys					Titanium Alloys		Hardened steel	Chilled Cast Iron	Hardened Cast Iron	
VDI 3323	21	22	23	24	25	26	27	28	29	30	31	32	33	34	35	36	37	38	39	40	41
HRc	60	100	75	90	130	110	90	100			200	280	250	350	320	400 Rm	1050 Rm	550	630	400	550
Recommend	○	○	○	○	○	○	○	○	○	○	○	○	○	○	○	○	○	○	○	○	○

CARBIDE, 4 FLUTE LONG LENGTH WITH CHAMFER

- **VOLLHARTMETALL, 4 SCHNEIDEN LANG**
- **Fraise carbure, 4 dents, longue**
- **4 TAGLIENTI, SERIE LUNGA**

- ▶ Suitable for dry milling applications at high temperatures.
- ▶ Excellent high-performance end mills.
- ▶ 4 flute allows for better work piece finishes.

- ▶ Für die Trockenbearbeitung.
- ▶ Hervorragendes Preis - Leistungsverhältnis.
- ▶ 4 Schneiden erzeugen eine bessere Oberflächengüte des Werkstücks.

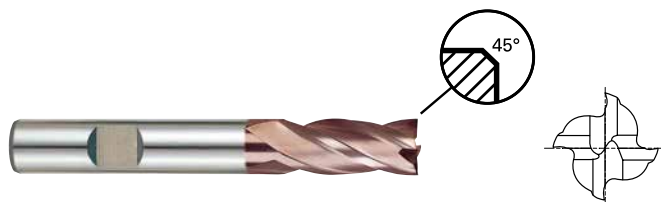

CARBIDE
DIN 6527
4
≈ 30°
DIN 6535HB
C x 45°
P.608

Unit : mm

EDP No.	Mill Diameter	Shank Diameter	Length of Cut	Overall Length	Chamfer
G9G51030	3.0	6	8	57	0.10
G9G51040	4.0	6	11	57	0.10
G9G51050	5.0	6	13	57	0.10
G9G51060	6.0	6	13	57	0.10
G9G51080	8.0	8	19	63	0.13
G9G51100	10.0	10	22	72	0.13
G9G51120	12.0	12	26	83	0.18
G9G51140	14.0	14	26	83	0.18
G9G51160	16.0	16	32	92	0.18
G9G51200	20.0	20	38	104	0.23

Mill Dia. Tolerance(mm)	Shank Dia. Tolerance
0 ~ - 0.03	h5

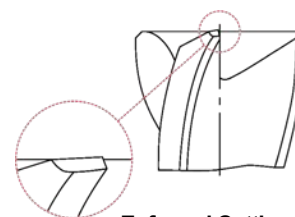

Enforced Cutting Edge

◎ : Excellent ○ : Good

ISO Material Description	P											M			K						
	Non-alloy steel					Low alloy steel				High alloyed steel, and tool steel		Stainless steel			Grey cast iron		Nodular cast iron	Malleable cast iron			
VDI 3323	1	2	3	4	5	6	7	8	9	10	11	12	13	14	15	16	17	18	19	20	
HRc		13	25	28	32	10	29	32	38	15	35	15	23	10	10	26	3	25		21	
HB	125	190	250	270	300	180	275	300	350	200	325	200	240	180	180	260	160	250	130	230	
Recommend	◎	◎	◎	◎	◎	◎	◎	◎	◎	◎	◎	○	○	○	○	○	○	○	○	○	
ISO Material Description	N										S						H				
	Aluminum-wrought alloy		Aluminum-cast, alloyed			Copper and Copper Alloys (Bronze / Brass)			Non Metallic Materials		Heat Resistant Super Alloys						Titanium Alloys		Hardened steel	Chilled Cast Iron	Hardened Cast Iron
VDI 3323	21	22	23	24	25	26	27	28	29	30	31	32	33	34	35	36	37	38	39	40	41
HRc											15	30	25	38	34			55	60	42	55
HB	60	100	75	90	130	110	90	100			200	280	250	350	320	400 Rm	1050 Rm	550	630	400	550
Recommend	○	○	○	○	○	○	○	○	○	○	○	○	○	○	○	○	○	○	○	○	○

CARBIDE, 4 FLUTE EXTRA LONG LENGTH

- VOLLHARTMETALL, 4 SCHNEIDEN EXTRA LANG
- Fraise carbure, 4 dents, extra-longue
- 4 TAGLIANTI, SERIE EXTRA LUNGA

- ▶ Suitable for dry milling applications at high temperatures.
- ▶ Excellent high-performance end mills.
- ▶ 4 flute allows for better work piece finishes.

- ▶ Für die Trockenbearbeitung.
- ▶ Hervorragendes Preis - Leistungsverhältnis.
- ▶ 4 Schneiden erzeugen eine bessere Oberflächengüte des Werkstücks.

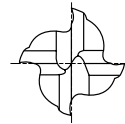

Unit : mm

EDP No.	Mill Diameter	Shank Diameter	Length of Cut	Overall Length
G9453903	3.0	3	20	60
G9453030	3.0	3	30	75
G9453904	4.0	4	20	60
G9453040	4.0	4	30	75
G9453905	5.0	5	25	75
G9453050	5.0	5	40	100
G9453906	6.0	6	30	75
G9453060	6.0	6	50	150
G9453908	8.0	8	30	75
G9453080	8.0	8	50	150
G9453910	10.0	10	40	100
G9453100	10.0	10	60	150
G9453912	12.0	12	45	100
G9453120	12.0	12	75	150
G9453914	14.0	14	45	100
G9453916	16.0	16	45	100
G9453160	16.0	16	65	150
G9453918	18.0	18	45	100
G9453920	20.0	20	45	100

Mill Dia. Tolerance(mm)	Shank Dia. Tolerance
0 ~ - 0.03	h5

◎ : Excellent ○ : Good

ISO Material Description	P										M				K						
	Non-alloy steel					Low alloy steel					High alloyed steel, and tool steel				Stainless steel		Grey cast iron		Nodular cast iron		Malleable cast iron
VDI 3323	1	2	3	4	5	6	7	8	9	10	11	12	13	14	15	16	17	18	19	20	
HRc	13	25	28	32	10	29	32	38	15	15	35	20	23	10	10	26	3	25	42	21	
HB	125	190	250	270	300	180	275	300	350	200	325	200	240	180	180	260	160	250	130	230	
Recommend	◎	◎	◎	◎	◎	◎	◎	◎	◎	◎	◎	◎	○	○	○	○	○	○	○	○	
ISO Material Description	N					S										H					
	Aluminum-wrought alloy		Aluminum-cast, alloyed			Copper and Copper Alloys (Bronze / Brass)			Non Metallic Materials		Heat Resistant Super Alloys					Titanium Alloys		Hardened steel	Chilled Cast Iron	Hardened Cast Iron	
VDI 3323	21	22	23	24	25	26	27	28	29	30	31	32	33	34	35	36	37	38	39	40	41
HRc	60	100	75	90	130	110	90	100			200	280	250	350	320	400 Rm	1050 Rm	550	630	400	550
Recommend	○	○	○	○	○	○	○	○	○	○	○	○	○	○	○	○	○	○	○	○	○



PLAIN SHANK **G9F45** SERIES
 PLAIN SHANK **G9F46** SERIES

CARBIDE, 4&6 FLUTE 45° HELIX SHORT / LONG LENGTH

● **VOLLHARTMETALL, 4&6 SCHNEIDEN 45° RECHTSSPIRALE KURZ / LANG**
 ● **Fraise carbure, 4&6 dents, hélice 45°, courte / longue**
 ● **4&6 TAGLIENTI, ELICA 45°, SERIE CORTA / LUNGA**

- ▶ Suitable for dry milling applications at high temperatures.
- ▶ Excellent high-performance end mills.
- ▶ Für die Trockenbearbeitung geeignet.
- ▶ Exzellente Hochleistungs Mühlen.

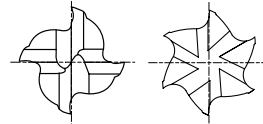

SHORT

Unit : mm

EDP No.	Mill Diameter	Shank Diameter	Length of Cut	Overall Length	No. of Flute
G9F45030	3.0	4	6	50	4
G9F45040	4.0	4	11	50	4
G9F45050	5.0	6	13	50	6
G9F45060	6.0	6	16	50	6
G9F45080	8.0	8	19	60	6
G9F45100	10.0	10	22	75	6
G9F45120	12.0	12	26	75	6
G9F45140	14.0	14	30	90	6
G9F45160	16.0	16	32	100	6
G9F45180	18.0	18	38	100	6
G9F45000	20.0	20	38	100	6

LONG

Unit : mm

EDP No.	Mill Diameter	Shank Diameter	Length of Cut	Overall Length	No. of Flute
G9F46120	12.0	12	50	100	6
G9F46160	16.0	16	65	150	6
G9F46200	20.0	20	75	150	6

Mill Dia. Tolerance(mm)	Shank Dia. Tolerance
0 ~ -0.03	h5

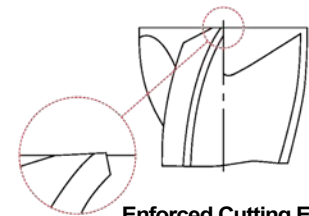

Enforced Cutting Edge

◎ : Excellent ○ : Good

ISO Material Description	P											M			K						
	Non-alloy steel					Low alloy steel						High alloyed steel, and tool steel			Stainless steel			Grey cast iron		Nodular cast iron	
VDI 3323	1	2	3	4	5	6	7	8	9	10	11	12	13	14	15	16	17	18	19	20	
HRc	13	25	28	32	10	29	32	38	15	35	15	23	10	10	26	3	25	42	21		
HB	125	190	250	270	300	180	275	300	350	200	325	200	240	180	180	260	160	250	130	230	
Recommend	○	○	○	○	○	○	○	○	○	◎	○	◎	○	○	○	○	○	○	○	○	
ISO Material Description	N										S						H				
	Aluminum-wrought alloy		Aluminum-cast, alloyed			Copper and Copper Alloys (Bronze / Brass)			Non Metallic Materials		Heat Resistant Super Alloys						Titanium Alloys		Hardened steel	Chilled Cast Iron	Hardened Cast Iron
VDI 3323	21	22	23	24	25	26	27	28	29	30	31	32	33	34	35	36	37	38	39	40	41
HRc	60	100	75	90	130	110	90	100			15	30	25	38	34	34	34	55	60	42	55
HB	60	100	75	90	130	110	90	100			200	280	250	350	320	400 Rm	1050 Rm	550	630	400	550
Recommend	○	○	○	○	○	○	○	○	○	○	○	○	○	○	○	○	○	○	○	○	○

CARBIDE, MULTI FLUTE LONG LENGTH ROUGHING - COARSE

- **VOLLHARTMETALL, MEHRSCHEIDEN LANG SCHRUPPFÄSER - GROB**
- ⌚ **Fraise carbure, multi-dents, ébauche, pas grossier, longue**
- 🇮🇹 **3 - 4 - 5 TAGLIANTI, PER SGROSSATURA, SERIE LUNGA - Bombato grosso**

- ▶ Suitable for dry milling applications at high temperatures.
- ▶ Excellent high-performance end mills.
- ▶ Fast chip ejection.

- ▶ Für die Trockenbearbeitung.
- ▶ Hervorragendes Preis - Leistungsverhältnis.
- ▶ Guter Spanauswurf.

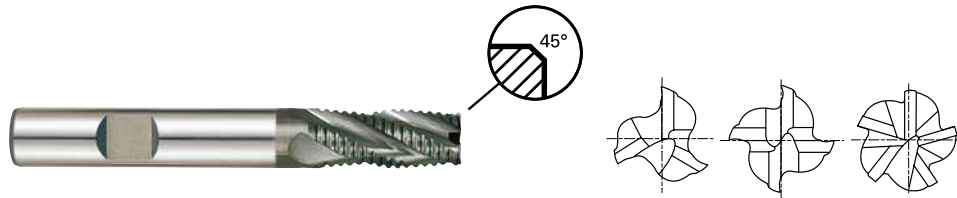

Unit : mm

EDP No.	Mill Diameter	Shank Diameter	Length of Cut	Overall Length	No. of Flute	Chamfer
	h10	h5				
G9A42060	6.0	6	16	57	3.00	0.60
G9A42080	8.0	8	16	63	3.00	0.60
G9A42100	10.0	10	22	72	4.00	0.60
G9A42120	12.0	12	26	83	4.00	0.74
G9A42140	14.0	14	26	83	4.00	0.94
G9A42160	16.0	16	32	92	4.00	0.94
G9A42180	18.0	18	32	92	4.00	0.94
G9A42200	20.0	20	38	104	4.00	0.94
G9A42250	25.0	25	45	121	5.00	0.94

Tolerances according to DIN 7160 & 7161

Tolerance range in μm					
Nominal-Diameter in mm					
	from 1 to 3	over 3 to 6	over 6 to 10	over 10 to 18	over 18 to 30
h10	0 - 40	0 - 48	0 - 58	0 - 70	0 - 84
h5	0 - 4	0 - 5	0 - 6	0 - 8	0 - 9

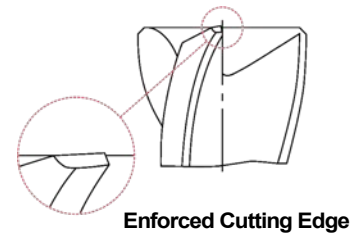

◎ : Excellent ○ : Good

ISO Material Description	P										M				K						
	Non-alloy steel					Low alloy steel					High alloyed steel, and tool steel				Stainless steel		Grey cast iron		Nodular cast iron		Malleable cast iron
VDI 3323	1	2	3	4	5	6	7	8	9	10	11	12	13	14	15	16	17	18	19	20	
HRc	13	25	28	32	30	29	32	38	35	35	35	15	23	10	10	26	3	25	42	55	
HB	125	190	250	270	300	180	275	300	350	200	325	200	240	180	180	260	160	250	130	230	
Recommend	◎	◎	◎	◎	◎	◎	◎	◎	◎	◎	◎	◎	○	○	○	○	○	○	○	○	
ISO Material Description	N										S						H				
	Aluminum-wrought alloy		Aluminum-cast, alloyed			Copper and Copper Alloys (Bronze / Brass)			Non Metallic Materials		Heat Resistant Super Alloys						Titanium Alloys		Hardened steel	Chilled Cast Iron	Hardened Cast Iron
VDI 3323	21	22	23	24	25	26	27	28	29	30	31	32	33	34	35	36	37	38	39	40	41
HRc											15	30	25	38	34			55	60	42	55
HB	60	100	75	90	130	110	90	100			200	280	250	350	320	400 Rm	1050 Rm	550	630	400	550
Recommend	○	○	○	○	○	○	○	○			○	○	○	○	○	○	○	○	○	○	○

CARBIDE, 2 FLUTE DRILL MILLS

- **VOLLHARTMETALL, 2 SCHNEIDEN BOHRNUTEN FRÄSER**
- **Fraise foret carbure, 2 dents, multi-fonctions**
- **2 TAGLIENTI, FRESA IN MD A 90°**



Unit : mm

EDP No.	Mill Diameter	Shank Diameter	Length of Cut	Overall Length
G9400030	3.0	4	6	50
G9400040	4.0	5	8	50
G9400050	5.0	6	10	50
G9400060	6.0	8	12	60
G9400080	8.0	10	16	70
G9400100	10.0	12	18	70
G9400120	12.0	12	20	70
G9400140	14.0	14	24	80
G9400160	16.0	16	26	80
G9400200	20.0	20	32	100

▶TiN, TiCN and TiAlN Coatings are available on your request.

- Performs many drilling and milling operations that are not presently done with the standard end mill.
- Among the many vertical milling machine operations, applications for the Drill Mill are: Drilling, Slotting, NC Milling, Drilling & Slotting, Profile Milling and Chamfering.

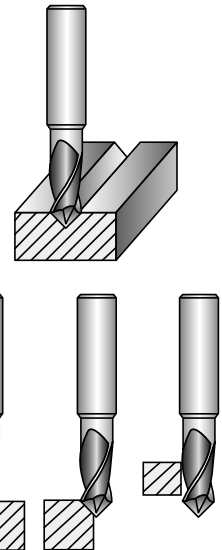
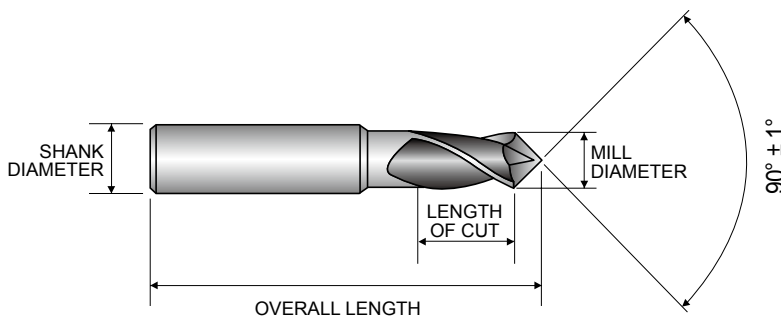

Mill Dia. Tolerance(mm)	Shank Dia. Tolerance
Ø3 ~ Ø10=h9	h5
Ø12 ~ Ø20=d9	

◎ : Excellent ○ : Good

ISO Material Description	P											M				K					
	Non-alloy steel					Low alloy steel			High alloyed steel, and tool steel			Stainless steel				Grey cast iron		Nodular cast iron		Malleable cast iron	
VDI 3323	1	2	3	4	5	6	7	8	9	10	11	12	13	14	15	16	17	18	19	20	
HRc	13	25	28	32	10	29	32	38	15	35	15	23	10	10	26	3	3	25	42	21	
HB	125	190	250	270	300	180	275	300	350	200	325	200	240	180	180	260	160	250	130	230	
Recommend	◎	◎	◎	◎	◎	◎	◎	◎	◎	◎	◎	○	○	○	○	○	○	○	○	○	
ISO Material Description	N										S							H			
	Aluminum-wrought alloy		Aluminum-cast, alloyed			Copper and Copper Alloys (Bronze / Brass)			Non Metallic Materials		Heat Resistant Super Alloys					Titanium Alloys		Hardened steel	Chilled Cast Iron	Hardened Cast Iron	
VDI 3323	21	22	23	24	25	26	27	28	29	30	31	32	33	34	35	36	37	38	39	40	41
HRc	60	100	75	90	130	110	90	100			15	30	25	38	34	55	60	55	60	42	55
HB	60	100	75	90	130	110	90	100			200	280	250	350	320	400 Rm	1050 Rm	550	630	400	550
Recommend	○	○	○	○	○																

Vc = m/min.
 fz = mm/tooth
 RPM = rev./min.
 FEED = mm/min.
 Ap = mm

G9624, G9A70, G9437, G9438, G9454, G9455 SERIES 2 FLUTE BALL NOSE

ISO	VDI 3323	Material Description	Ae	Parameter	Mill Diameter (Ø)															
					2.0	3.0	4.0	5.0	6.0	8.0	10.0	12.0	14.0	16.0	18.0	20.0				
P	1-4	Non-alloy steel	0.2D	Vc	80	105	110	125	135	155	170	190	200	205	215	225				
				fz	0.026	0.025	0.035	0.045	0.06	0.089	0.122	0.15	0.165	0.18	0.188	0.201				
				RPM	12732	11141	8754	7958	7162	6167	5411	5040	4547	4078	3802	3581				
				FEED	662	557	613	716	859	1098	1320	1512	1501	1468	1430	1440				
				Ap	0.2	0.2	0.2	0.2	0.2	0.3	0.3	0.3	0.3	0.3	0.3	0.3				
	5			Low alloy steel	0.2D	Vc	55	80	90	95	110	125	135	150	160	160	170	175		
						fz	0.023	0.023	0.031	0.04	0.06	0.08	0.1	0.12	0.128	0.141	0.148	0.158		
						RPM	8754	8488	7162	6048	5836	4974	4297	3979	3638	3183	3006	2785		
						FEED	403	390	444	484	700	796	859	955	931	898	890	880		
						Ap	0.2	0.2	0.2	0.2	0.2	0.3	0.3	0.3	0.3	0.3	0.3	0.3		
	6-7	High alloyed steel, and tool steel	0.2D			Vc	80	105	110	125	135	155	170	190	200	205	215	225		
						fz	0.026	0.025	0.035	0.045	0.06	0.089	0.122	0.15	0.165	0.18	0.188	0.201		
						RPM	12732	11141	8754	7958	7162	6167	5411	5040	4547	4078	3802	3581		
						FEED	662	557	613	716	859	1098	1320	1512	1501	1468	1430	1440		
						Ap	0.2	0.2	0.2	0.2	0.2	0.3	0.3	0.3	0.3	0.3	0.3	0.3		
	8-9			High alloyed steel, and tool steel	0.2D	Vc	55	80	90	95	110	125	135	150	160	160	170	175		
						fz	0.023	0.023	0.031	0.04	0.06	0.08	0.1	0.12	0.128	0.141	0.148	0.158		
						RPM	8754	8488	7162	6048	5836	4974	4297	3979	3638	3183	3006	2785		
						FEED	403	390	444	484	700	796	859	955	931	898	890	880		
						Ap	0.2	0.2	0.2	0.2	0.2	0.3	0.3	0.3	0.3	0.3	0.3	0.3		
10	High alloyed steel, and tool steel	0.2D	Vc			80	105	110	125	135	155	170	190	200	205	215	225			
			fz			0.026	0.025	0.035	0.045	0.06	0.089	0.122	0.15	0.165	0.18	0.188	0.201			
			RPM			12732	11141	8754	7958	7162	6167	5411	5040	4547	4078	3802	3581			
			FEED			662	557	613	716	859	1098	1320	1512	1501	1468	1430	1440			
			Ap			0.2	0.2	0.2	0.2	0.2	0.3	0.3	0.3	0.3	0.3	0.3	0.3			
11.1 - 11.2			High alloyed steel, and tool steel	0.2D	Vc	55	80	90	95	110	125	135	150	160	160	170	175			
					fz	0.023	0.023	0.031	0.04	0.06	0.08	0.1	0.12	0.128	0.141	0.148	0.158			
					RPM	8754	8488	7162	6048	5836	4974	4297	3979	3638	3183	3006	2785			
					FEED	403	390	444	484	700	796	859	955	931	898	890	880			
					Ap	0.2	0.2	0.2	0.2	0.2	0.3	0.3	0.3	0.3	0.3	0.3	0.3			
K	15-20	Grey cast iron Nodular cast iron Malleable cast iron			0.7D	Vc	65	65	65	65	65	65	65	65	65	65	60	65		
						fz	0.01	0.016	0.028	0.04	0.053	0.092	0.112	0.131	0.164	0.177	0.209	0.2		
						RPM	10345	6897	5173	4138	3448	2586	2069	1724	1364	1293	1061	1035		
						FEED	207	221	290	331	366	476	463	452	447	458	444	414		
						Ap	0.3	0.3	0.3	0.3	0.3	0.3	0.3	0.3	0.3	0.3	0.3	0.3		
N	21~22	Aluminum-wrought alloy	0.7D	Vc	195	195	195	190	195	200	195	195	190	195	190	185				
				fz	0.006	0.01	0.013	0.019	0.023	0.034	0.044	0.061	0.073	0.07	0.079	0.092				
				RPM	31035	20690	15518	12096	10345	7958	6207	5173	4320	3879	3360	2944				
				FEED	372	414	403	460	476	541	546	631	631	543	531	542				
				Ap	0.3	0.3	0.3	0.3	0.3	0.3	0.3	0.3	0.3	0.3	0.3	0.3				
	23~25	Aluminum-cast, alloyed	0.7D	Vc	195	195	195	190	195	200	195	195	190	195	190	185				
				fz	0.006	0.01	0.013	0.019	0.023	0.034	0.044	0.061	0.073	0.07	0.079	0.092				
				RPM	31035	20690	15518	12096	10345	7958	6207	5173	4320	3879	3360	2944				
				FEED	372	414	403	460	476	541	546	631	631	543	531	542				
				Ap	0.3	0.3	0.3	0.3	0.3	0.3	0.3	0.3	0.3	0.3	0.3	0.3				
H	38.1	Hardened steel	0.2D	Vc	25	35	45	50	50	50	55	55	60	60	60					
				fz	0.016	0.016	0.021	0.024	0.03	0.046	0.054	0.07	0.081	0.091	0.1	0.111				
				RPM	3979	3714	3581	3183	2653	1989	1751	1459	1251	1194	1061	955				
				FEED	127	119	150	153	159	183	189	204	203	217	212	212				
				Ap	0.2	0.2	0.2	0.2	0.2	0.3	0.3	0.3	0.3	0.3	0.3	0.3				
	40	Chilled Cast Iron	0.2D	Vc	55	80	90	95	110	125	135	150	160	160	170	175				
				fz	0.023	0.023	0.031	0.04	0.06	0.08	0.1	0.12	0.128	0.141	0.148	0.158				
				RPM	8754	8488	7162	6048	5836	4974	4297	3979	3638	3183	3006	2785				
				FEED	403	390	444	484	700	796	859	955	931	898	890	880				
				Ap	0.2	0.2	0.2	0.2	0.2	0.3	0.3	0.3	0.3	0.3	0.3	0.3				

※ The FEED, in long & extra long types, should be reduced by around 50%

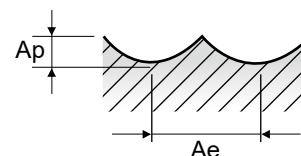

G9B81 SERIES **2 FLUTE BALL NOSE**

Vc = m/min.
fz = mm/tooth
RPM = rev./min.
FEED = mm/min.
Ap = mm

ISO	VDI 3323	Material Description	Parameter	Mill Diameter (Ø)				
				0.4	0.5	0.6	0.8	1.0
P	1-4	Non-alloy steel	Vc	33~43	41~53	50~64	66~85	77~97
			fz	0.003~0.006	0.003~0.006	0.004~0.008	0.004~0.008	0.004~0.010
	RPM		26350~34000	26350~34000	26350~34000	26350~34000	24650~31000	
	FEED		150~415	150~415	190~535	190~535	210~595	
	Ap		0.018~0.036	0.023~0.045	0.027~0.054	0.036~0.072	0.045~0.090	
	Vc		24~30	30~38	36~46	48~61	55~69	
	5	Low alloy steel	fz	0.002~0.005	0.002~0.005	0.002~0.006	0.002~0.006	0.003~0.007
			RPM	19100~24200	19100~24200	19100~24200	19100~24200	17400~22100
	FEED		75~230	75~230	95~300	95~300	105~330	
	Ap		0.018~0.036	0.023~0.045	0.027~0.054	0.036~0.072	0.045~0.090	
	Vc		24~30	30~38	36~46	48~61	55~69	
	fz		0.002~0.005	0.002~0.005	0.002~0.006	0.002~0.006	0.003~0.007	
6-7	High alloyed steel, and tool steel	RPM	19100~24200	19100~24200	19100~24200	19100~24200	17400~22100	
		FEED	75~230	75~230	95~300	95~300	105~330	
Ap		0.018~0.036	0.023~0.045	0.027~0.054	0.036~0.072	0.045~0.090		
Vc		24~30	30~38	36~46	48~61	55~69		
fz		0.002~0.005	0.002~0.005	0.002~0.006	0.002~0.006	0.003~0.007		
RPM		19100~24200	19100~24200	19100~24200	19100~24200	17400~22100		
8-9	High alloyed steel, and tool steel	FEED	75~230	75~230	95~300	95~300	105~330	
		Ap	0.018~0.036	0.023~0.045	0.027~0.054	0.036~0.072	0.045~0.090	
Vc		33~43	41~53	50~64	66~85	77~97		
fz		0.003~0.006	0.003~0.006	0.004~0.008	0.004~0.008	0.004~0.010		
RPM		26350~34000	26350~34000	26350~34000	26350~34000	24650~31000		
FEED		150~415	150~415	190~535	190~535	210~595		
10	High alloyed steel, and tool steel	Ap	0.018~0.036	0.023~0.045	0.027~0.054	0.036~0.072	0.045~0.090	
		Vc	24~30	30~38	36~46	48~61	55~69	
fz		0.002~0.005	0.002~0.005	0.002~0.006	0.002~0.006	0.003~0.007		
RPM		19100~24200	19100~24200	19100~24200	19100~24200	17400~22100		
FEED		75~230	75~230	95~300	95~300	105~330		
Ap		0.018~0.036	0.023~0.045	0.027~0.054	0.036~0.072	0.045~0.090		
11.1 - 11.2	High alloyed steel, and tool steel	Vc	33~43	41~53	50~64	66~85	77~97	
		fz	0.003~0.006	0.003~0.006	0.004~0.008	0.004~0.008	0.004~0.010	
RPM		26350~34000	26350~34000	26350~34000	26350~34000	24650~31000		
FEED		150~415	150~415	190~535	190~535	210~595		
Ap		0.018~0.036	0.023~0.045	0.027~0.054	0.036~0.072	0.045~0.090		
Vc		24~30	30~38	36~46	48~61	55~69		

※ The FEED, in long & extra long types, should be reduced by around 50%

▶ NEXT PAGE

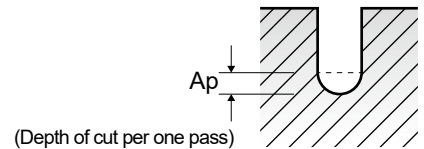

G9B81 SERIES 2 FLUTE BALL NOSE

Vc = m/min.
fz = mm/tooth
RPM = rev./min.
FEED = mm/min.
Ap = mm

VDI 3323	Parameter	Mill Diameter (Ø)							
		1.2	1.4	1.5	1.6	1.8	2.0	3.0	4.0
1-4	Vc	77~98	79~97	75~97	78~101	82~103	82~101	85~104	90~117
	fz	0.005~0.013	0.006~0.015	0.007~0.016	0.007~0.017	0.007~0.018	0.008~0.021	0.012~0.030	0.015~0.036
	RPM	20500~26000	18000~22000	16000~20500	15500~20000	14500~18200	13000~16000	9000~11000	7200~9350
	FEED	210~665	210~665	210~665	210~665	210~665	210~665	210~665	210~665
5	Ap	0.055~0.100	0.062~0.125	0.070~0.135	0.075~0.145	0.080~0.160	0.090~0.180	0.135~0.270	0.180~0.360
	Vc	55~69	56~67	54~70	56~70	58~72	59~72	57~108	63~83
	fz	0.004~0.009	0.004~0.011	0.005~0.011	0.005~0.012	0.005~0.013	0.006~0.014	0.009~0.014	0.011~0.025
	RPM	14500~18300	12800~15300	11500~14900	11200~14000	10200~12800	9400~11500	6000~11500	5000~6600
6-7	FEED	105~330	105~330	105~330	105~330	105~330	105~330	105~330	105~330
	Ap	0.055~0.100	0.062~0.125	0.070~0.135	0.075~0.145	0.080~0.160	0.090~0.180	0.135~0.270	0.180~0.360
	Vc	77~98	79~97	75~97	78~101	82~103	82~101	85~104	90~117
	fz	0.005~0.013	0.006~0.015	0.007~0.016	0.007~0.017	0.007~0.018	0.008~0.021	0.012~0.030	0.015~0.036
8-9	RPM	20500~26000	18000~22000	16000~20500	15500~20000	14500~18200	13000~16000	9000~11000	7200~9350
	FEED	210~665	210~665	210~665	210~665	210~665	210~665	210~665	210~665
	Ap	0.055~0.100	0.062~0.125	0.070~0.135	0.075~0.145	0.080~0.160	0.090~0.180	0.135~0.270	0.180~0.360
	Vc	55~69	56~67	54~70	56~70	58~72	59~72	57~108	63~83
10	fz	0.004~0.009	0.004~0.011	0.005~0.011	0.005~0.012	0.005~0.013	0.006~0.014	0.009~0.014	0.011~0.025
	RPM	14500~18300	12800~15300	11500~14900	11200~14000	10200~12800	9400~11500	6000~11500	5000~6600
	FEED	105~330	105~330	105~330	105~330	105~330	105~330	105~330	105~330
	Ap	0.055~0.100	0.062~0.125	0.070~0.135	0.075~0.145	0.080~0.160	0.090~0.180	0.135~0.270	0.180~0.360
11.1 - 11.2	Vc	55~69	56~67	54~70	56~70	58~72	59~72	57~108	63~83
	fz	0.004~0.009	0.004~0.011	0.005~0.011	0.005~0.012	0.005~0.013	0.006~0.014	0.009~0.014	0.011~0.025
	RPM	14500~18300	12800~15300	11500~14900	11200~14000	10200~12800	9400~11500	6000~11500	5000~6600
	FEED	105~330	105~330	105~330	105~330	105~330	105~330	105~330	105~330
	Ap	0.055~0.100	0.062~0.125	0.070~0.135	0.075~0.145	0.080~0.160	0.090~0.180	0.135~0.270	0.180~0.360

※ The FEED, in long & extra long types, should be reduced by around 50%

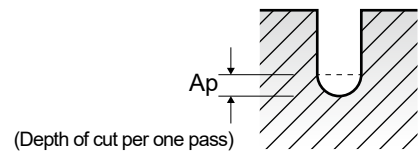

HSS

CBN END MILLS

i-Xmill END MILLS

i-SMART MODULAR END MILLS

X5070 END MILLS

4G MILL END MILLS

X-POWER PRO END MILLS

TitaNox-POWER END MILLS

JET-POWER END MILLS

V7 PLUS END MILLS

ALU-POWER HPC END MILLS

ALU-POWER END MILLS

D-POWER GRAPHITE END MILLS

D-POWER CFRP END MILLS

ROUTERS

CRX S END MILLS

K-2 END MILLS

ONLY ONE COATED PM60 END MILLS

TANK-POWER END MILLS

GENERAL HSS END MILLS

MILLING CUTTERS

TECHNICAL DATA

G9634 SERIES **4 FLUTE BALL NOSE**

Vc = m/min.
fz = mm/tooth
RPM = rev./min.
FEED = mm/min.

ISO	VDI 3323	Material Description	Ae	Parameter	Mill Diameter (Ø)											
					2.0	3.0	4.0	5.0	6.0	8.0	10.0	12.0	14.0	16.0	18.0	20.0
P	1-4	Non-alloy steel	0.2D	Vc	85	110	110	125	135	155	170	190	200	205	215	225
				fz	0.013	0.019	0.027	0.033	0.046	0.068	0.089	0.112	0.124	0.136	0.14	0.15
				RPM	13528	11671	8754	7958	7162	6167	5411	5040	4547	4078	3802	3581
				FEED	703	887	945	1050	1318	1677	1926	2258	2255	2219	2129	2149
	5	Non-alloy steel	0.2D	Vc	65	80	90	95	110	125	135	150	160	160	170	175
				fz	0.01	0.017	0.024	0.03	0.046	0.06	0.076	0.089	0.099	0.108	0.111	0.119
				RPM	10345	8488	7162	6048	5836	4974	4297	3979	3638	3183	3006	2785
				FEED	414	577	688	726	1074	1194	1306	1416	1441	1375	1335	1326
	6-7	Low alloy steel	0.2D	Vc	85	110	110	125	135	155	170	190	200	205	215	225
				fz	0.013	0.019	0.027	0.033	0.046	0.068	0.089	0.112	0.124	0.136	0.14	0.15
				RPM	13528	11671	8754	7958	7162	6167	5411	5040	4547	4078	3802	3581
				FEED	703	887	945	1050	1318	1677	1926	2258	2255	2219	2129	2149
8-9	Low alloy steel	0.2D	Vc	65	80	90	95	110	125	135	150	160	160	170	175	
			fz	0.01	0.017	0.024	0.03	0.046	0.06	0.076	0.089	0.099	0.108	0.111	0.119	
			RPM	10345	8488	7162	6048	5836	4974	4297	3979	3638	3183	3006	2785	
			FEED	414	577	688	726	1074	1194	1306	1416	1441	1375	1335	1326	
10	High alloyed steel, and tool steel	0.2D	Vc	85	110	110	125	135	155	170	190	200	205	215	225	
			fz	0.013	0.019	0.027	0.033	0.046	0.068	0.089	0.112	0.124	0.136	0.14	0.15	
			RPM	13528	11671	8754	7958	7162	6167	5411	5040	4547	4078	3802	3581	
			FEED	703	887	945	1050	1318	1677	1926	2258	2255	2219	2129	2149	
11.1 - 11.2	High alloyed steel, and tool steel	0.2D	Vc	65	80	90	95	110	125	135	150	160	160	170	175	
			fz	0.01	0.017	0.024	0.03	0.046	0.06	0.076	0.089	0.099	0.108	0.111	0.119	
			RPM	10345	8488	7162	6048	5836	4974	4297	3979	3638	3183	3006	2785	
			FEED	414	577	688	726	1074	1194	1306	1416	1441	1375	1335	1326	
K	15-20	Grey cast iron Nodular cast iron Malleable cast iron	0.7D	Vc	65	65	65	65	65	65	65	65	60	65	60	65
				fz	0.008	0.012	0.021	0.03	0.04	0.068	0.083	0.097	0.125	0.135	0.159	0.15
				RPM	10345	6897	5173	4138	3448	2586	2069	1724	1364	1293	1061	1035
				FEED	331	331	434	497	552	703	687	669	682	698	675	621
N	21~22	Aluminum-wrought alloy	0.7D	Vc	195	195	195	190	195	200	195	195	190	195	190	185
				fz	0.005	0.007	0.01	0.015	0.017	0.026	0.033	0.046	0.055	0.053	0.06	0.069
				RPM	31035	20690	15518	12096	10345	7958	6207	5173	4320	3879	3360	2944
				FEED	621	579	621	726	703	828	819	952	950	822	806	813
H	38.1	Hardened steel	0.2D	Vc	25	35	45	50	50	55	55	55	55	55	60	60
				fz	0.008	0.012	0.016	0.019	0.022	0.034	0.041	0.053	0.062	0.073	0.076	0.084
				RPM	3979	3714	3581	3183	2653	2188	1751	1459	1251	1094	1061	955
				FEED	127	178	229	242	233	298	287	309	310	320	323	321
H	40	Chilled Cast Iron	0.2D	Vc	65	80	90	95	110	125	135	150	160	160	170	175
				fz	0.01	0.017	0.024	0.03	0.046	0.06	0.076	0.089	0.099	0.108	0.111	0.119
				RPM	10345	8488	7162	6048	5836	4974	4297	3979	3638	3183	3006	2785
				FEED	414	577	688	726	1074	1194	1306	1416	1441	1375	1335	1326

※ The FEED, in long & extra long types, should be reduced by around 50%

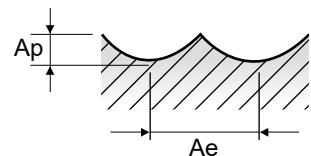

G9B82, G9B83 SERIES 2 FLUTE CORNER RADIUS - **SLOTTING**

Vc = m/min.
fz = mm/tooth
RPM = rev./min.
FEED = mm/min.

ISO	VDI 3323	Material Description	Ae	Ap	Parameter	Mill Diameter (Ø)							
						2.0	3.0	4.0	5.0	6.0	8.0	10.0	12.0
P	1-4	Non-alloy steel	1.0D	0.5D (Up to Ø3 : 0.2D)	Vc	50	55	65	70	70	70	70	70
					fz	0.01	0.015	0.025	0.031	0.039	0.057	0.064	0.065
	RPM		7958	5836	5173	4456	3714	2785	2228	1857			
	FEED		159	175	259	276	290	318	285	241			
	5	Low alloy steel	1.0D	0.5D (Up to Ø3 : 0.2D)	Vc	30	35	40	40	45	45	40	45
					fz	0.01	0.016	0.025	0.031	0.041	0.05	0.05	0.048
	RPM		4775	3714	3183	2546	2387	1790	1273	1194			
	FEED		95	119	159	158	196	179	127	115			
	6-7	Low alloy steel	1.0D	0.5D (Up to Ø3 : 0.2D)	Vc	50	55	65	70	70	70	70	70
					fz	0.01	0.015	0.025	0.031	0.039	0.057	0.064	0.065
	RPM		7958	5836	5173	4456	3714	2785	2228	1857			
	FEED		159	175	259	276	290	318	285	241			
8-9	Low alloy steel	1.0D	0.5D (Up to Ø3 : 0.2D)	Vc	30	35	40	40	45	45	40	45	
				fz	0.01	0.016	0.025	0.031	0.041	0.05	0.05	0.048	
RPM		4775	3714	3183	2546	2387	1790	1273	1194				
FEED		95	119	159	158	196	179	127	115				
10	High alloyed steel, and tool steel	1.0D	0.5D (Up to Ø3 : 0.2D)	Vc	50	55	65	70	70	70	70	70	
				fz	0.01	0.015	0.025	0.031	0.039	0.057	0.064	0.065	
RPM		7958	5836	5173	4456	3714	2785	2228	1857				
FEED		159	175	259	276	290	318	285	241				
11.1 - 11.2	High alloyed steel, and tool steel	1.0D	0.5D (Up to Ø3 : 0.2D)	Vc	30	35	40	40	45	45	40	45	
				fz	0.01	0.016	0.025	0.031	0.041	0.05	0.05	0.048	
RPM		4775	3714	3183	2546	2387	1790	1273	1194				
FEED		95	119	159	158	196	179	127	115				
M	14.1	Stainless steel	1.0D	0.5D (Up to Ø3 : 0.2D)	Vc	25	30	35	35	35	35	35	35
					fz	0.009	0.016	0.025	0.031	0.04	0.053	0.059	0.058
RPM					3979	3183	2785	2228	1857	1393	1114	928	
FEED					72	102	139	138	149	148	131	108	
K	15-20	Grey cast iron Nodular cast iron Malleable cast iron	1.0D	1.0D	Vc	60	55	60	55	55	55	60	55
					fz	0.012	0.018	0.024	0.03	0.043	0.063	0.077	0.102
RPM					9549	5836	4775	3501	2918	2188	1910	1459	
FEED					229	210	229	210	251	276	294	298	
N	21~22	Aluminum-wrought alloy	1.0D	1.0D	Vc	140	145	140	145	145	145	145	140
					fz	0.01	0.015	0.021	0.025	0.032	0.043	0.053	0.065
					RPM	22282	15385	11141	9231	7692	5769	4615	3714
					FEED	446	462	468	462	492	496	489	483
	23~25	Aluminum-cast, alloyed	1.0D	1.0D	Vc	140	145	140	145	145	145	145	140
					fz	0.01	0.015	0.021	0.025	0.032	0.043	0.053	0.065
					RPM	22282	15385	11141	9231	7692	5769	4615	3714
					FEED	446	462	468	462	492	496	489	483
	26-28	Copper and Copper Alloys (Bronze / Brass)	1.0D	1.0D	Vc	105	105	110	105	105	110	105	105
					fz	0.01	0.015	0.019	0.025	0.033	0.043	0.055	0.066
					RPM	16711	11141	8754	6685	5570	4377	3342	2785
					FEED	334	334	333	334	368	376	368	368
29.1	Non Metallic Materials	1.0D	1.0D	Vc	105	105	110	105	105	110	105	105	
				fz	0.01	0.015	0.019	0.025	0.033	0.043	0.055	0.066	
				RPM	16711	11141	8754	6685	5570	4377	3342	2785	
				FEED	334	334	333	334	368	376	368	368	
H	40	Chilled Cast Iron	1.0D	1.0D	Vc	30	35	40	40	45	45	40	45
					fz	0.01	0.016	0.025	0.031	0.041	0.05	0.05	0.048
RPM					4775	3714	3183	2546	2387	1790	1273	1194	
FEED					95	119	159	158	196	179	127	115	

※ The FEED, in long & extra long types, should be reduced by around 50%

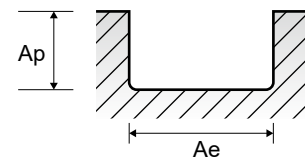

HSS

CBN END MILLS

i-Xmill END MILLS

i-SMART MODULAR END MILLS

X5070 END MILLS

4G MILL END MILLS

X-POWER PRO END MILLS

TitaNox-POWER END MILLS

JET-POWER END MILLS

V7 PLUS END MILLS

ALU-POWER HPC END MILLS

ALU-POWER END MILLS

D-POWER GRAPHITE END MILLS

D-POWER CFRP END MILLS

ROUTERS

CRX S END MILLS

K-2 END MILLS

ONLY ONE COATED PM60 END MILLS

TANK-POWER END MILLS

GENERAL HSS END MILLS

MILLING CUTTERS

TECHNICAL DATA

G9B84, G9B85 SERIES 4 FLUTE CORNER RADIUS - SIDE CUTTING

Vc = m/min.
fz = mm/tooth
RPM = rev./min.
FEED = mm/min.

ISO	VDI 3323	Material Description	Ae	Ap	Parameter	Mill Diameter (Ø)									
						1.0	1.5	2.0	3.0	4.0	5.0	6.0	8.0	10.0	12.0
P	1-4	Non-alloy steel	0.1D	1.0D	Vc	55	55	60	70	80	85	90	90	85	90
					fz	0.002	0.005	0.006	0.009	0.019	0.024	0.029	0.043	0.047	0.047
	RPM	17507	11671	9549	7427	6366	5411	4775	3581	2706	2387				
	FEED	140	233	229	267	484	519	554	616	509	449				
	5	Non-alloy steel	0.1D	1.0D	Vc	30	35	40	45	50	50	55	55	55	55
					fz	0.002	0.004	0.006	0.009	0.019	0.024	0.031	0.038	0.038	0.037
	RPM	9549	7427	6366	4775	3979	3183	2918	2188	1751	1459				
	FEED	76	119	153	172	302	306	362	333	266	216				
	6-7	Low alloy steel	0.1D	1.0D	Vc	55	55	60	70	80	85	90	90	85	90
					fz	0.002	0.005	0.006	0.009	0.019	0.024	0.029	0.043	0.047	0.047
RPM	17507	11671	9549	7427	6366	5411	4775	3581	2706	2387					
FEED	140	233	229	267	484	519	554	616	509	449					
8-9	Low alloy steel	0.1D	1.0D	Vc	30	35	40	45	50	50	55	55	55	55	
				fz	0.002	0.004	0.006	0.009	0.019	0.024	0.031	0.038	0.038	0.037	
RPM	9549	7427	6366	4775	3979	3183	2918	2188	1751	1459					
FEED	76	119	153	172	302	306	362	333	266	216					
10	High alloyed steel, and tool steel	0.1D	1.0D	Vc	55	55	60	70	80	85	90	90	85	90	
				fz	0.002	0.005	0.006	0.009	0.019	0.024	0.029	0.043	0.047	0.047	
RPM	17507	11671	9549	7427	6366	5411	4775	3581	2706	2387					
FEED	140	233	229	267	484	519	554	616	509	449					
11.1 - 11.2	High alloyed steel, and tool steel	0.1D	1.0D	Vc	30	35	40	45	50	50	55	55	55	55	
				fz	0.002	0.004	0.006	0.009	0.019	0.024	0.031	0.038	0.038	0.037	
RPM	9549	7427	6366	4775	3979	3183	2918	2188	1751	1459					
FEED	76	119	153	172	302	306	362	333	266	216					
M	14.1	Stainless steel	0.1D	1.0D	Vc	25	35	35	35	40	40	45	45	45	45
fz	0.002	0.004	0.006	0.009	0.018	0.024	0.029	0.042	0.044	0.045					
RPM	7958	7427	5570	3714	3183	2546	2387	1790	1432	1194					
FEED	64	119	134	134	229	244	277	301	252	215					
K	15-20	Grey cast iron Nodular cast iron Malleable cast iron	0.1D	1.5D	Vc	60	55	60	55	60	55	55	55	60	55
					fz	0.008	0.013	0.017	0.026	0.035	0.044	0.065	0.093	0.116	0.155
RPM	19099	11671	9549	5836	4775	3501	2918	2188	1910	1459					
FEED	611	607	649	607	668	616	759	814	886	905					
N	21~22	Aluminum-wrought alloy	0.1D	1.5D	Vc	140	130	140	145	140	145	145	145	145	140
					fz	0.006	0.011	0.015	0.021	0.03	0.036	0.047	0.063	0.078	0.095
	RPM	44563	27587	22282	15385	11141	9231	7692	5769	4615	3714				
	FEED	1070	1214	1337	1292	1337	1329	1446	1454	1440	1411				
	23~25	Aluminum-cast, alloyed	0.1D	1.5D	Vc	140	130	140	145	140	145	145	145	145	140
					fz	0.006	0.011	0.015	0.021	0.03	0.036	0.047	0.063	0.078	0.095
	RPM	44563	27587	22282	15385	11141	9231	7692	5769	4615	3714				
	FEED	1070	1214	1337	1292	1337	1329	1446	1454	1440	1411				
	26-28	Copper and Copper Alloys (Bronze / Brass)	0.1D	1.5D	Vc	80	95	105	105	110	105	105	110	105	105
					fz	0.006	0.011	0.016	0.024	0.029	0.038	0.048	0.063	0.081	0.096
RPM	25465	20160	16711	11141	8754	6685	5570	4377	3342	2785					
FEED	611	887	1070	1070	1015	1016	1070	1103	1083	1070					
29.1	Non Metallic Materials	0.1D	1.5D	Vc	80	95	105	105	110	105	105	110	105	105	
				fz	0.006	0.011	0.016	0.024	0.029	0.038	0.048	0.063	0.081	0.096	
RPM	25465	20160	16711	11141	8754	6685	5570	4377	3342	2785					
FEED	611	887	1070	1070	1015	1016	1070	1103	1083	1070					
H	40	Chilled Cast Iron	0.1D	1.0D	Vc	30	35	40	45	50	50	55	55	55	55
fz	0.002	0.004	0.006	0.009	0.019	0.024	0.031	0.038	0.038	0.037					
RPM	9549	7427	6366	4775	3979	3183	2918	2188	1751	1459					
FEED	76	119	153	172	302	306	362	333	266	216					

※ The FEED, in long & extra long types, should be reduced by around 50%

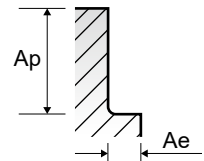

G9424, G9G44, G9A68, G9444, G9527, G9445, G9G45, G9452 SERIES
2 FLUTE - SLOTTING

 Vc = m/min.
 fz = mm/tooth
 RPM = rev./min.
 FEED = mm/min.

ISO	VDI 3323	Material Description	Ae	Ap	Parameter	Mill Diameter (Ø)																																																								
						1.0	1.5	2.0	3.0	4.0	5.0	6.0	8.0	10.0	12.0	14.0	16.0	20.0																																												
P	1-4	Non-alloy steel	1.0D	0.5D (Up to Ø3 : 0.2D)	Vc	45	45	50	55	65	70	70	70	70	70	75	75	70	fz	0.004	0.008	0.01	0.015	0.025	0.031	0.039	0.057	0.064	0.065	0.063	0.062	0.063	RPM	14324	9549	7958	5836	5173	4456	3714	2785	2228	1857	1705	1492	1114	FEED	115	153	159	175	259	276	290	318	285	241	215	185	140		
					Vc	25	25	30	35	40	40	45	45	40	45	45	40	45	45	50	45	fz	0.004	0.008	0.01	0.016	0.025	0.031	0.041	0.05	0.05	0.048	0.048	0.05	0.05	RPM	7958	5305	4775	3714	3183	2546	2387	1790	1273	1194	1023	995	716	FEED	64	85	95	119	159	158	196	179	127	115	98	99
	Vc				45	45	50	55	65	70	70	70	70	70	70	70	70	75	75	70	fz	0.004	0.008	0.01	0.015	0.025	0.031	0.039	0.057	0.064	0.065	0.063	0.062	0.063	RPM	14324	9549	7958	5836	5173	4456	3714	2785	2228	1857	1705	1492	1114	FEED	115	153	159	175	259	276	290	318	285	241	215	185	140
	Vc				25	25	30	35	40	40	45	45	40	45	45	40	45	45	50	45	fz	0.004	0.008	0.01	0.016	0.025	0.031	0.041	0.05	0.05	0.048	0.048	0.05	0.05	RPM	7958	5305	4775	3714	3183	2546	2387	1790	1273	1194	1023	995	716	FEED	64	85	95	119	159	158	196	179	127	115	98	99	72
	Vc				45	45	50	55	65	70	70	70	70	70	70	70	70	75	75	70	fz	0.004	0.008	0.01	0.015	0.025	0.031	0.039	0.057	0.064	0.065	0.063	0.062	0.063	RPM	14324	9549	7958	5836	5173	4456	3714	2785	2228	1857	1705	1492	1114	FEED	115	153	159	175	259	276	290	318	285	241	215	185	140
	Vc				25	25	30	35	40	40	45	45	40	45	45	40	45	45	50	45	fz	0.004	0.008	0.01	0.016	0.025	0.031	0.041	0.05	0.05	0.048	0.048	0.05	0.05	RPM	7958	5305	4775	3714	3183	2546	2387	1790	1273	1194	1023	995	716	FEED	64	85	95	119	159	158	196	179	127	115	98	99	72
	Vc	45	45	50	55	65	70	70	70	70	70	70	70	70	75	75	70	fz	0.004	0.008	0.01	0.015	0.025	0.031	0.039	0.057	0.064	0.065	0.063	0.062	0.063	RPM	14324	9549	7958	5836	5173	4456	3714	2785	2228	1857	1705	1492	1114	FEED	115	153	159	175	259	276	290	318	285	241	215	185	140			
	Vc	25	25	30	35	40	40	45	45	40	45	45	40	45	45	50	45	fz	0.004	0.008	0.01	0.016	0.025	0.031	0.041	0.05	0.05	0.048	0.048	0.05	0.05	RPM	7958	5305	4775	3714	3183	2546	2387	1790	1273	1194	1023	995	716	FEED	64	85	95	119	159	158	196	179	127	115	98	99	72			
	Vc	45	45	50	55	65	70	70	70	70	70	70	70	70	75	75	70	fz	0.004	0.008	0.01	0.015	0.025	0.031	0.039	0.057	0.064	0.065	0.063	0.062	0.063	RPM	14324	9549	7958	5836	5173	4456	3714	2785	2228	1857	1705	1492	1114	FEED	115	153	159	175	259	276	290	318	285	241	215	185	140			
	Vc	25	25	30	35	40	40	45	45	40	45	45	40	45	45	50	45	fz	0.004	0.008	0.01	0.016	0.025	0.031	0.041	0.05	0.05	0.048	0.048	0.05	0.05	RPM	7958	5305	4775	3714	3183	2546	2387	1790	1273	1194	1023	995	716	FEED	64	85	95	119	159	158	196	179	127	115	98	99	72			
	M	14.1	Stainless steel	1.0D	0.5D (Up to Ø3 : 0.2D)	Vc	20	25	25	30	35	35	35	35	35	35	35	35	fz	0.003	0.007	0.009	0.016	0.025	0.031	0.04	0.053	0.059	0.058	0.059	0.068	0.064	RPM	6366	5305	3979	3183	2785	2228	1857	1393	1114	928	796	696	557	FEED	38	74	72	102	139	138	149	148	131	108	94	95	71		
	K	15-20	Grey cast iron Nodular cast iron Malleable cast iron	1.0D	1.0D	Vc	60	55	60	55	60	55	55	55	60	55	55	55	fz	0.005	0.008	0.012	0.018	0.024	0.03	0.043	0.063	0.077	0.102	0.119	0.145	0.189	RPM	19099	11671	9549	5836	4775	3501	2918	2188	1910	1459	1251	1094	875	FEED	191	187	229	210	229	210	251	276	294	298	298	317	331		
N	21~22	Aluminum-wrought alloy	1.0D	1.0D	Vc	140	130	140	145	140	145	145	145	145	140	145	140	fz	0.004	0.007	0.01	0.015	0.021	0.025	0.032	0.043	0.053	0.065	0.073	0.085	0.11	RPM	44563	27587	22282	15385	11141	9231	7692	5769	4615	3714	3297	2885	2228	FEED	357	386	446	462	468	462	492	496	489	483	481	490	490			
	23~25	Aluminum-cast, alloyed	1.0D	1.0D	Vc	140	130	140	145	140	145	145	145	145	140	145	140	fz	0.004	0.007	0.01	0.015	0.021	0.025	0.032	0.043	0.053	0.065	0.073	0.085	0.11	RPM	44563	27587	22282	15385	11141	9231	7692	5769	4615	3714	3297	2885	2228	FEED	357	386	446	462	468	462	492	496	489	483	481	490	490			
	26-28	Copper and Copper Alloys (Bronze / Brass)	1.0D	1.0D	Vc	80	95	105	105	110	105	105	110	105	105	110	105	fz	0.004	0.007	0.01	0.015	0.019	0.025	0.033	0.043	0.055	0.066	0.078	0.085	0.11	RPM	25465	20160	16711	11141	8754	6685	5570	4377	3342	2785	2387	2188	1671	FEED	204	282	334	334	333	334	368	376	368	368	372	372	368			
	29.1	Non Metallic Materials	1.0D	1.0D	Vc	80	95	105	105	110	105	105	110	105	105	110	105	fz	0.004	0.007	0.01	0.015	0.019	0.025	0.033	0.043	0.055	0.066	0.078	0.085	0.11	RPM	25465	20160	16711	11141	8754	6685	5570	4377	3342	2785	2387	2188	1671	FEED	204	282	334	334	333	334	368	376	368	368	372	372	368			
H	40	Chilled Cast Iron	1.0D	0.5D (Up to Ø3 : 0.2D)	Vc	25	25	30	35	40	40	45	45	40	45	45	45	fz	0.004	0.008	0.01	0.016	0.025	0.031	0.041	0.05	0.05	0.048	0.048	0.05	0.05	RPM	7958	5305	4775	3714	3183	2546	2387	1790	1273	1194	1023	995	716	FEED	64	85	95	119	159	158	196	179	127	115	98	99	72			

※ The FEED, in long & extra long types, should be reduced by around 50%

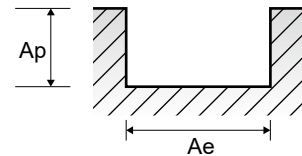

G9B80 SERIES **2 FLUTE - SLOTTING**

Vc = m/min.
fz = mm/tooth
RPM = rev./min.
FEED = mm/min.
Ap = mm

ISO	VDI 3323	Material Description	Parameter	Mill Diameter (Ø)						
				0.4	0.5	0.6	0.7	0.8	0.9	1.0
P	1-4	Non-alloy steel	Vc	33~43	42~53	50~64	58~75	58~75	61~76	60~75
			fz	0.003~0.005	0.003~0.005	0.004~0.007	0.004~0.007	0.005~0.009	0.006~0.011	0.006~0.014
			RPM	26500~34000	26500~34000	26500~34000	26500~34000	23000~30000	21500~27000	19000~24000
			FEED	170~370	170~370	210~485	210~485	240~535	240~610	240~690
			Ap	0.007~0.018	0.009~0.022	0.011~0.026	0.012~0.031	0.014~0.035	0.030~0.060	0.045~0.090
			Ap	0.007~0.018	0.009~0.022	0.011~0.026	0.012~0.031	0.014~0.035	0.030~0.060	0.045~0.090
	5	Non-alloy steel	Vc	24~30	30~38	36~45	42~53	41~53	42~54	42~53
			fz	0.002~0.006	0.002~0.006	0.003~0.008	0.003~0.008	0.003~0.010	0.005~0.012	0.006~0.015
			RPM	19000~24000	19000~24000	19000~24000	19000~24000	16500~21000	15000~19000	13500~17000
			FEED	72~290	72~290	95~365	95~365	100~410	135~460	160~510
			Ap	0.007~0.018	0.009~0.022	0.011~0.026	0.012~0.031	0.014~0.035	0.030~0.060	0.045~0.090
			Ap	0.007~0.018	0.009~0.022	0.011~0.026	0.012~0.031	0.014~0.035	0.030~0.060	0.045~0.090
6-7	Low alloy steel	Vc	33~43	42~53	50~64	58~75	58~75	61~76	60~75	
		fz	0.003~0.005	0.003~0.005	0.004~0.007	0.004~0.007	0.005~0.009	0.006~0.011	0.006~0.014	
		RPM	26500~34000	26500~34000	26500~34000	26500~34000	23000~30000	21500~27000	19000~24000	
		FEED	170~370	170~370	210~485	210~485	240~535	240~610	240~690	
		Ap	0.007~0.018	0.009~0.022	0.011~0.026	0.012~0.031	0.014~0.035	0.030~0.060	0.045~0.090	
		Ap	0.007~0.018	0.009~0.022	0.011~0.026	0.012~0.031	0.014~0.035	0.030~0.060	0.045~0.090	
8-9	Low alloy steel	Vc	24~30	30~38	36~45	42~53	41~53	42~54	42~53	
		fz	0.002~0.006	0.002~0.006	0.003~0.008	0.003~0.008	0.003~0.010	0.005~0.012	0.006~0.015	
		RPM	19000~24000	19000~24000	19000~24000	19000~24000	16500~21000	15000~19000	13500~17000	
		FEED	72~290	72~290	95~365	95~365	100~410	135~460	160~510	
		Ap	0.007~0.018	0.009~0.022	0.011~0.026	0.012~0.031	0.014~0.035	0.030~0.060	0.045~0.090	
		Ap	0.007~0.018	0.009~0.022	0.011~0.026	0.012~0.031	0.014~0.035	0.030~0.060	0.045~0.090	
10	High alloyed steel, and tool steel	Vc	33~43	42~53	50~64	58~75	58~75	61~76	60~75	
		fz	0.003~0.005	0.003~0.005	0.004~0.007	0.004~0.007	0.005~0.009	0.006~0.011	0.006~0.014	
		RPM	26500~34000	26500~34000	26500~34000	26500~34000	23000~30000	21500~27000	19000~24000	
		FEED	170~370	170~370	210~485	210~485	240~535	240~610	240~690	
		Ap	0.007~0.018	0.009~0.022	0.011~0.026	0.012~0.031	0.014~0.035	0.030~0.060	0.045~0.090	
		Ap	0.007~0.018	0.009~0.022	0.011~0.026	0.012~0.031	0.014~0.035	0.030~0.060	0.045~0.090	
11.1 - 11.2	High alloyed steel, and tool steel	Vc	24~30	30~38	36~45	42~53	41~53	42~54	42~53	
		fz	0.002~0.006	0.002~0.006	0.003~0.008	0.003~0.008	0.003~0.010	0.005~0.012	0.006~0.015	
		RPM	19000~24000	19000~24000	19000~24000	19000~24000	16500~21000	15000~19000	13500~17000	
		FEED	72~290	72~290	95~365	95~365	100~410	135~460	160~510	
		Ap	0.007~0.018	0.009~0.022	0.011~0.026	0.012~0.031	0.014~0.035	0.030~0.060	0.045~0.090	
		Ap	0.007~0.018	0.009~0.022	0.011~0.026	0.012~0.031	0.014~0.035	0.030~0.060	0.045~0.090	

※ The FEED, in long & extra long types, should be reduced by around 50%

▶ NEXT PAGE

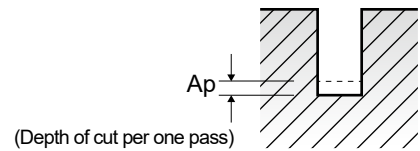

G9B80 SERIES **2 FLUTE - SLOTTING**

Vc = m/min.
fz = mm/tooth
RPM = rev./min.
FEED = mm/min.
Ap = mm

VDI 3323	Parameter	Mill Diameter (Ø)								
		1.2	1.4	1.5	1.6	1.8	2.0	2.5	3.0	4.0
1-4	Vc	58~72	60~75	59~73	60~75	62~79	63~79	63~79	64~80	64~82
	fz	0.008~0.020	0.009~0.023	0.010~0.025	0.010~0.026	0.011~0.027	0.012~0.031	0.015~0.038	0.018~0.045	0.024~0.059
	RPM	15500~19000	13600~17000	12500~15500	12000~15000	11000~14000	10000~12500	8000~10000	6800~8500	5100~6500
	FEED	240~765	240~765	240~765	240~765	240~765	240~765	240~765	240~765	240~765
5	Ap	0.055~0.100	0.062~0.125	0.070~0.135	0.075~0.145	0.080~0.160	0.090~0.180	0.112~0.235	0.135~0.270	0.180~0.360
	Vc	41~53	43~53	42~54	44~55	44~55	44~56	45~57	44~57	44~57
	fz	0.007~0.018	0.008~0.021	0.009~0.022	0.009~0.023	0.010~0.026	0.011~0.028	0.014~0.035	0.017~0.043	0.023~0.057
	RPM	11000~14000	9800~12000	8950~11500	8700~10900	7800~9800	7000~8950	5700~7200	4700~6000	3500~4500
6-7	FEED	160~510	160~510	160~510	160~510	160~510	160~510	160~510	160~510	160~510
	Ap	0.055~0.100	0.062~0.125	0.070~0.135	0.075~0.145	0.080~0.160	0.090~0.180	0.112~0.235	0.135~0.270	0.180~0.360
	Vc	58~72	60~75	59~73	60~75	62~79	63~79	63~79	64~80	64~82
	fz	0.008~0.020	0.009~0.023	0.010~0.025	0.010~0.026	0.011~0.027	0.012~0.031	0.015~0.038	0.018~0.045	0.024~0.059
8-9	RPM	15500~19000	13600~17000	12500~15500	12000~15000	11000~14000	10000~12500	8000~10000	6800~8500	5100~6500
	FEED	240~765	240~765	240~765	240~765	240~765	240~765	240~765	240~765	240~765
	Ap	0.055~0.100	0.062~0.125	0.070~0.135	0.075~0.145	0.080~0.160	0.090~0.180	0.112~0.235	0.135~0.270	0.180~0.360
	Vc	41~53	43~53	42~54	44~55	44~55	44~56	45~57	44~57	44~57
10	fz	0.007~0.018	0.008~0.021	0.009~0.022	0.009~0.023	0.010~0.026	0.011~0.028	0.014~0.035	0.017~0.043	0.023~0.057
	RPM	11000~14000	9800~12000	8950~11500	8700~10900	7800~9800	7000~8950	5700~7200	4700~6000	3500~4500
	FEED	160~510	160~510	160~510	160~510	160~510	160~510	160~510	160~510	160~510
	Ap	0.055~0.100	0.062~0.125	0.070~0.135	0.075~0.145	0.080~0.160	0.090~0.180	0.112~0.235	0.135~0.270	0.180~0.360
11.1 - 11.2	Vc	58~72	60~75	59~73	60~75	62~79	63~79	63~79	64~80	64~82
	fz	0.008~0.020	0.009~0.023	0.010~0.025	0.010~0.026	0.011~0.027	0.012~0.031	0.015~0.038	0.018~0.045	0.024~0.059
	RPM	15500~19000	13600~17000	12500~15500	12000~15000	11000~14000	10000~12500	8000~10000	6800~8500	5100~6500
	FEED	240~765	240~765	240~765	240~765	240~765	240~765	240~765	240~765	240~765
11.2	Ap	0.055~0.100	0.062~0.125	0.070~0.135	0.075~0.145	0.080~0.160	0.090~0.180	0.112~0.235	0.135~0.270	0.180~0.360
	Vc	41~53	43~53	42~54	44~55	44~55	44~56	45~57	44~57	44~57
	fz	0.007~0.018	0.008~0.021	0.009~0.022	0.009~0.023	0.010~0.026	0.011~0.028	0.014~0.035	0.017~0.043	0.023~0.057
	RPM	11000~14000	9800~12000	8950~11500	8700~10900	7800~9800	7000~8950	5700~7200	4700~6000	3500~4500
11.2	FEED	160~510	160~510	160~510	160~510	160~510	160~510	160~510	160~510	160~510
	Ap	0.055~0.100	0.062~0.125	0.070~0.135	0.075~0.145	0.080~0.160	0.090~0.180	0.112~0.235	0.135~0.270	0.180~0.360
	Vc	58~72	60~75	59~73	60~75	62~79	63~79	63~79	64~80	64~82
	fz	0.008~0.020	0.009~0.023	0.010~0.025	0.010~0.026	0.011~0.027	0.012~0.031	0.015~0.038	0.018~0.045	0.024~0.059

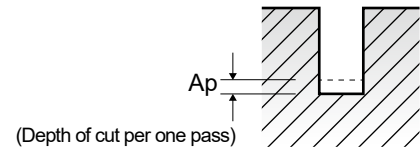

HSS

CBN END MILLS

i-Xmill END MILLS

i-SMART MODULAR END MILLS

X5070 END MILLS

4G MILL END MILLS

X-POWER PRO END MILLS

TitaNox-POWER END MILLS

JET-POWER END MILLS

V7 PLUS END MILLS

ALU-POWER HPC END MILLS

ALU-POWER END MILLS

D-POWER GRAPHITE END MILLS

D-POWER CFRP END MILLS

ROUTERS

CRX S END MILLS

K-2 END MILLS

ONLY ONE COATED PM60 END MILLS

TANK-POWER END MILLS

GENERAL HSS END MILLS

MILLING CUTTERS

TECHNICAL DATA

**G9553, G9G46, G9410, G9425, G9G47, G9439
G9528, G9433, G9G48, G9447, G9G49** SERIES

3 FLUTE - SLOTTING

Vc = m/min.
fz = mm/tooth
RPM = rev./min.
FEED = mm/min.

ISO	VDI 3323	Material Description	Ae	Ap	Parameter	Mill Diameter (Ø)																																																								
						1.0	1.5	2.0	3.0	4.0	5.0	6.0	8.0	10.0	12.0	14.0	16.0	20.0																																												
P	1-4	Non-alloy steel	1.0D	0.5D (Up to Ø3 : 0.2D)	Vc	45	60	50	55	65	70	70	70	70	75	75	70	fz	0.002	0.003	0.005	0.007	0.012	0.015	0.018	0.027	0.03	0.031	0.029	0.029	0.029	RPM	14324	12732	7958	5836	5173	4456	3714	2785	2228	1857	1705	1492	1492	1114	FEED	86	115	119	123	186	201	201	226	201	173	148	130	97		
					Vc	25	25	30	35	40	40	45	45	40	45	45	45	50	45	fz	0.002	0.004	0.005	0.007	0.012	0.014	0.02	0.024	0.023	0.022	0.022	0.023	0.024	RPM	7958	5305	4775	3714	3183	2546	2387	1790	1273	1194	1023	995	716	FEED	48	64	72	78	115	107	143	129	88	79	68	69	52	
	5		Low alloy steel	1.0D	0.5D (Up to Ø3 : 0.2D)	Vc	45	60	50	55	65	70	70	70	70	75	75	70	fz	0.002	0.003	0.005	0.007	0.012	0.015	0.018	0.027	0.03	0.031	0.029	0.029	0.029	RPM	14324	12732	7958	5836	5173	4456	3714	2785	2228	1857	1705	1492	1492	1114	FEED	86	115	119	123	186	201	201	226	201	173	148	130	97	
						Vc	25	25	30	35	40	40	45	45	40	45	45	45	50	45	fz	0.002	0.004	0.005	0.007	0.012	0.014	0.02	0.024	0.023	0.022	0.022	0.023	0.024	RPM	7958	5305	4775	3714	3183	2546	2387	1790	1273	1194	1023	995	716	FEED	48	64	72	78	115	107	143	129	88	79	68	69	52
	6-7			High alloyed steel, and tool steel	1.0D	0.5D (Up to Ø3 : 0.2D)	Vc	45	60	50	55	65	70	70	70	70	75	75	70	fz	0.002	0.003	0.005	0.007	0.012	0.015	0.018	0.027	0.03	0.031	0.029	0.029	0.029	RPM	14324	12732	7958	5836	5173	4456	3714	2785	2228	1857	1705	1492	1492	1114	FEED	86	115	119	123	186	201	201	226	201	173	148	130	97
							Vc	25	25	30	35	40	40	45	45	40	45	45	45	50	45	fz	0.002	0.004	0.005	0.007	0.012	0.014	0.02	0.024	0.023	0.022	0.022	0.023	0.024	RPM	7958	5305	4775	3714	3183	2546	2387	1790	1273	1194	1023	995	716	FEED	48	64	72	78	115	107	143	129	88	79	68	69
	8-9	High alloyed steel, and tool steel			1.0D	0.5D (Up to Ø3 : 0.2D)	Vc	45	60	50	55	65	70	70	70	70	75	75	70	fz	0.002	0.003	0.005	0.007	0.012	0.015	0.018	0.027	0.03	0.031	0.029	0.029	0.029	RPM	14324	12732	7958	5836	5173	4456	3714	2785	2228	1857	1705	1492	1492	1114	FEED	86	115	119	123	186	201	201	226	201	173	148	130	97
							Vc	25	25	30	35	40	40	45	45	40	45	45	45	50	45	fz	0.002	0.004	0.005	0.007	0.012	0.014	0.02	0.024	0.023	0.022	0.022	0.023	0.024	RPM	7958	5305	4775	3714	3183	2546	2387	1790	1273	1194	1023	995	716	FEED	48	64	72	78	115	107	143	129	88	79	68	69
	10		Stainless steel		1.0D	0.5D (Up to Ø3 : 0.2D)	Vc	45	60	50	55	65	70	70	70	70	75	75	70	fz	0.002	0.003	0.005	0.007	0.012	0.015	0.018	0.027	0.03	0.031	0.029	0.029	0.029	RPM	14324	12732	7958	5836	5173	4456	3714	2785	2228	1857	1705	1492	1492	1114	FEED	86	115	119	123	186	201	201	226	201	173	148	130	97
							Vc	25	25	30	35	40	40	45	45	40	45	45	45	50	45	fz	0.002	0.004	0.005	0.007	0.012	0.014	0.02	0.024	0.023	0.022	0.022	0.023	0.024	RPM	7958	5305	4775	3714	3183	2546	2387	1790	1273	1194	1023	995	716	FEED	48	64	72	78	115	107	143	129	88	79	68	69
	11.1 - 11.2			Stainless steel	1.0D	0.5D (Up to Ø3 : 0.2D)	Vc	20	25	25	30	35	35	35	35	35	35	35	35	fz	0.002	0.003	0.004	0.007	0.011	0.015	0.019	0.025	0.028	0.026	0.027	0.031	0.03	RPM	6366	5305	3979	3183	2785	2228	1857	1393	1114	928	796	696	557	FEED	38	48	48	67	92	100	106	104	94	72	64	65	50	
							Vc	60	55	60	55	60	55	55	55	60	55	55	55	55	55	fz	0.003	0.005	0.007	0.011	0.013	0.018	0.026	0.036	0.046	0.063	0.073	0.086	0.115	RPM	19099	11671	9549	5836	4775	3501	2918	2188	1910	1459	1251	1094	875	FEED	172	175	201	193	186	189	228	236	264	276	274	282
M	14.1	Stainless steel			1.0D	0.5D (Up to Ø3 : 0.2D)	Vc	20	25	25	30	35	35	35	35	35	35	35	fz	0.002	0.003	0.004	0.007	0.011	0.015	0.019	0.025	0.028	0.026	0.027	0.031	0.03	RPM	6366	5305	3979	3183	2785	2228	1857	1393	1114	928	796	696	557	FEED	38	48	48	67	92	100	106	104	94	72	64	65	50		
K	15-20	Grey cast iron Nodular cast iron Malleable cast iron			1.0D	1.0D	Vc	60	55	60	55	60	55	55	55	60	55	55	fz	0.003	0.005	0.007	0.011	0.013	0.018	0.026	0.036	0.046	0.063	0.073	0.086	0.115	RPM	19099	11671	9549	5836	4775	3501	2918	2188	1910	1459	1251	1094	875	FEED	172	175	201	193	186	189	228	236	264	276	274	282	302		
N	21~22	Aluminum-wrought alloy	1.0D		1.0D	Vc	140	130	140	145	140	145	145	145	145	140	145	140	fz	0.002	0.004	0.006	0.009	0.013	0.015	0.019	0.026	0.032	0.038	0.043	0.05	0.065	RPM	44563	27587	22282	15385	11141	9231	7692	5769	4615	3714	3297	2885	2228	FEED	267	331	401	415	434	415	438	450	443	423	425	433	434		
						Vc	140	130	140	145	140	145	145	145	145	140	145	140	145	140	fz	0.002	0.004	0.006	0.009	0.013	0.015	0.019	0.026	0.032	0.038	0.043	0.05	0.065	RPM	44563	27587	22282	15385	11141	9231	7692	5769	4615	3714	3297	2885	2228	FEED	267	331	401	415	434	415	438	450	443	423	425	433	434
	23~25		Aluminum-cast, alloyed	1.0D	1.0D	Vc	140	130	140	145	140	145	145	145	145	140	145	140	fz	0.002	0.004	0.006	0.009	0.013	0.015	0.019	0.026	0.032	0.038	0.043	0.05	0.065	RPM	44563	27587	22282	15385	11141	9231	7692	5769	4615	3714	3297	2885	2228	FEED	267	331	401	415	434	415	438	450	443	423	425	433	434		
						Vc	80	95	105	105	110	105	105	110	105	105	105	105	110	105	fz	0.002	0.004	0.006	0.009	0.012	0.015	0.02	0.025	0.032	0.039	0.046	0.05	0.065	RPM	25465	20160	16711	11141	8754	6685	5570	4377	3342	2785	2387	2188	1671	FEED	153	242	301	301	315	301	334	328	321	326	329	328	326
	26-28	Copper and Copper Alloys (Bronze / Brass)		1.0D	1.0D	Vc	80	95	105	105	110	105	105	110	105	105	105	110	105	fz	0.002	0.004	0.006	0.009	0.012	0.015	0.02	0.025	0.032	0.039	0.046	0.05	0.065	RPM	25465	20160	16711	11141	8754	6685	5570	4377	3342	2785	2387	2188	1671	FEED	153	242	301	301	315	301	334	328	321	326	329	328	326	
						Vc	80	95	105	105	110	105	105	110	105	105	105	105	110	105	fz	0.002	0.004	0.006	0.009	0.012	0.015	0.02	0.025	0.032	0.039	0.046	0.05	0.065	RPM	25465	20160	16711	11141	8754	6685	5570	4377	3342	2785	2387	2188	1671	FEED	153	242	301	301	315	301	334	328	321	326	329	328	326
	29.1		Non Metallic Materials	1.0D	1.0D	Vc	80	95	105	105	110	105	105	110	105	105	105	110	105	fz	0.002	0.004	0.006	0.009	0.012	0.015	0.02	0.025	0.032	0.039	0.046	0.05	0.065	RPM	25465	20160	16711	11141	8754	6685	5570	4377	3342	2785	2387	2188	1671	FEED	153	242	301	301	315	301	334	328	321	326	329	328	326	
						Vc	80	95	105	105	110	105	105	110	105	105	110	105	105	110	105	fz	0.002	0.004	0.006	0.009	0.012	0.015	0.02	0.025	0.032	0.039	0.046	0.05	0.065	RPM	25465	20160	16711	11141	8754	6685	5570	4377	3342	2785	2387	2188	1671	FEED	153	242	301	301	315	301	334	328	321	326	329	328
H	40	Chilled Cast Iron		1.0D	0.5D (Up to Ø3 : 0.2D)	Vc	25	25	30	35	40	40	45	45	40	45	45	fz	0.002	0.004	0.005	0.007	0.012	0.014	0.02	0.024	0.023	0.022	0.022	0.023	0.024	RPM	7958	5305	4775	3714	3183	2546																								

G9553, G9G46, G9410, G9425, G9G47, G9439 G9528, G9433, G9G48, G9447, G9G49 SERIES

3 FLUTE - SIDE CUTTING

Vc = m/min.
fz = mm/tooth
RPM = rev./min.
FEED = mm/min.

ISO	VDI 3323	Material Description	Ae	Ap	Parameter	Mill Diameter (Ø)																																																						
						1.0	1.5	2.0	3.0	4.0	5.0	6.0	8.0	10.0	12.0	14.0	16.0	20.0																																										
P	1-4	Non-alloy steel	0.1D	1.0D	Vc	55	55	60	70	80	85	90	90	85	90	90	95	90	fz	0.002	0.005	0.006	0.009	0.019	0.024	0.03	0.042	0.047	0.047	0.047	0.048	0.047	RPM	17507	11671	9549	7427	6366	5411	4775	3581	2706	2387	2046	1890	1432	FEED	105	175	172	201	363	390	430	451	381	337	289	272	202
					Vc	30	35	40	45	50	50	55	55	55	55	55	55	55	60	55	fz	0.002	0.004	0.006	0.009	0.019	0.024	0.031	0.038	0.038	0.037	0.037	0.038	0.037	RPM	9549	7427	6366	4775	3979	3183	2918	2188	1751	1459	1251	1194	875	FEED	57	89	115	129	227	229	271	249	200	162	139
	5		0.1D	1.0D	Vc	55	55	60	70	80	85	90	90	85	90	90	95	90	fz	0.002	0.005	0.006	0.009	0.019	0.024	0.03	0.042	0.047	0.047	0.047	0.048	0.047	RPM	17507	11671	9549	7427	6366	5411	4775	3581	2706	2387	2046	1890	1432	FEED	105	175	172	201	363	390	430	451	381	337	289	272	202
					Vc	30	35	40	45	50	50	55	55	55	55	55	55	60	55	fz	0.002	0.004	0.006	0.009	0.019	0.024	0.031	0.038	0.038	0.037	0.037	0.038	0.037	RPM	9549	7427	6366	4775	3979	3183	2918	2188	1751	1459	1251	1194	875	FEED	57	89	115	129	227	229	271	249	200	162	139	136
	6-7		0.1D	1.0D	Vc	55	55	60	70	80	85	90	90	85	90	90	95	90	fz	0.002	0.005	0.006	0.009	0.019	0.024	0.03	0.042	0.047	0.047	0.047	0.048	0.047	RPM	17507	11671	9549	7427	6366	5411	4775	3581	2706	2387	2046	1890	1432	FEED	105	175	172	201	363	390	430	451	381	337	289	272	202
					Vc	30	35	40	45	50	50	55	55	55	55	55	55	60	55	fz	0.002	0.004	0.006	0.009	0.019	0.024	0.031	0.038	0.038	0.037	0.037	0.038	0.037	RPM	9549	7427	6366	4775	3979	3183	2918	2188	1751	1459	1251	1194	875	FEED	57	89	115	129	227	229	271	249	200	162	139	136
	8-9	0.1D	1.0D	Vc	55	55	60	70	80	85	90	90	85	90	90	95	90	fz	0.002	0.005	0.006	0.009	0.019	0.024	0.03	0.042	0.047	0.047	0.047	0.048	0.047	RPM	17507	11671	9549	7427	6366	5411	4775	3581	2706	2387	2046	1890	1432	FEED	105	175	172	201	363	390	430	451	381	337	289	272	202	
				Vc	30	35	40	45	50	50	55	55	55	55	55	55	60	55	fz	0.002	0.004	0.006	0.009	0.019	0.024	0.031	0.038	0.038	0.037	0.037	0.038	0.037	RPM	9549	7427	6366	4775	3979	3183	2918	2188	1751	1459	1251	1194	875	FEED	57	89	115	129	227	229	271	249	200	162	139	136	97
	10	0.1D	1.0D	Vc	55	55	60	70	80	85	90	90	85	90	90	95	90	fz	0.002	0.005	0.006	0.009	0.019	0.024	0.03	0.042	0.047	0.047	0.047	0.048	0.047	RPM	17507	11671	9549	7427	6366	5411	4775	3581	2706	2387	2046	1890	1432	FEED	105	175	172	201	363	390	430	451	381	337	289	272	202	
				Vc	30	35	40	45	50	50	55	55	55	55	55	55	60	55	fz	0.002	0.004	0.006	0.009	0.019	0.024	0.031	0.038	0.038	0.037	0.037	0.038	0.037	RPM	9549	7427	6366	4775	3979	3183	2918	2188	1751	1459	1251	1194	875	FEED	57	89	115	129	227	229	271	249	200	162	139	136	97
	11.1 - 11.2	0.1D	1.0D	Vc	55	55	60	70	80	85	90	90	85	90	90	95	90	fz	0.002	0.005	0.006	0.009	0.019	0.024	0.03	0.042	0.047	0.047	0.047	0.048	0.047	RPM	17507	11671	9549	7427	6366	5411	4775	3581	2706	2387	2046	1890	1432	FEED	105	175	172	201	363	390	430	451	381	337	289	272	202	
				Vc	30	35	40	45	50	50	55	55	55	55	55	55	60	55	fz	0.002	0.004	0.006	0.009	0.019	0.024	0.031	0.038	0.038	0.037	0.037	0.038	0.037	RPM	9549	7427	6366	4775	3979	3183	2918	2188	1751	1459	1251	1194	875	FEED	57	89	115	129	227	229	271	249	200	162	139	136	97
M	14.1	Stainless steel	0.1D	1.0D	Vc	25	35	35	35	40	40	45	45	45	45	45	fz	0.002	0.004	0.006	0.009	0.018	0.024	0.03	0.042	0.045	0.045	0.044	0.048	0.048	RPM	7958	7427	5570	3714	3183	2546	2387	1790	1432	1194	1023	895	716	FEED	48	89	100	100	172	183	215	226	193	161	135	129	103		
K	15-20	Grey cast iron Nodular cast iron Malleable cast iron	0.1D	1.5D	Vc	60	55	60	55	60	55	55	55	60	55	55	55	fz	0.008	0.013	0.017	0.026	0.035	0.044	0.064	0.093	0.115	0.154	0.181	0.22	0.285	RPM	19099	11671	9549	5836	4775	3501	2918	2188	1910	1459	1251	1094	878	FEED	458	665	487	455	501	462	560	611	659	674	679	722	745	
N	21~22	Aluminum- wrought alloy	0.1D	1.5D	Vc	140	130	140	145	140	145	145	145	145	140	145	140	fz	0.006	0.01	0.016	0.021	0.031	0.037	0.048	0.064	0.08	0.098	0.111	0.129	0.167	RPM	44563	27587	22282	15385	11141	9231	7692	5769	4615	3714	3297	2885	2228	FEED	802	828	1070	969	1036	1025	1108	1108	1108	1092	1098	1116	1116	
					Vc	140	130	140	145	140	145	145	145	145	145	145	140	145	140	fz	0.006	0.01	0.016	0.021	0.031	0.037	0.048	0.064	0.08	0.098	0.111	0.129	0.167	RPM	44563	27587	22282	15385	11141	9231	7692	5769	4615	3714	3297	2885	2228	FEED	802	828	1070	969	1036	1025	1108	1108	1108	1092	1098	1116
	23~25	Aluminum-cast, alloyed	0.1D	1.5D	Vc	80	95	105	105	110	105	105	110	105	105	110	105	fz	0.006	0.011	0.016	0.023	0.029	0.037	0.048	0.063	0.081	0.096	0.115	0.125	0.162	RPM	25465	20160	16711	11141	8754	6685	5570	4377	3342	2785	2387	2188	1671	FEED	458	665	802	769	762	742	802	827	812	802	824	821	812	
					Vc	80	95	105	105	110	105	105	110	105	105	110	105	105	110	105	fz	0.006	0.011	0.016	0.023	0.029	0.037	0.048	0.063	0.081	0.096	0.115	0.125	0.162	RPM	25465	20160	16711	11141	8754	6685	5570	4377	3342	2785	2387	2188	1671	FEED	458	665	802	769	762	742	802	827	812	802	824
26-28	Copper and Copper Alloys (Bronze / Brass)	0.1D	1.5D	Vc	80	95	105	105	110	105	105	110	105	105	110	105	fz	0.006	0.011	0.016	0.023	0.029	0.037	0.048	0.063	0.081	0.096	0.115	0.125	0.162	RPM	25465	20160	16711	11141	8754	6685	5570	4377	3342	2785	2387	2188	1671	FEED	458	665	802	769	762	742	802	827	812	802	824	821	812		
				Vc	80	95	105	105	110	105	105	110	105	105	110	105	105	110	105	fz	0.006	0.011	0.016	0.023	0.029	0.037	0.048	0.063	0.081	0.096	0.115	0.125	0.162	RPM	25465	20160	16711	11141	8754	6685	5570	4377	3342	2785	2387	2188	1671	FEED	458	665	802	769	762	742	802	827	812	802	824	821
29.1	Non Metallic Materials	0.1D	1.5D	Vc	80	95	105	105	110	105	105	110	105	105	110	105	fz	0.006	0.011	0.016	0.023	0.029	0.037	0.048	0.063	0.081	0.096	0.115	0.125	0.162	RPM	25465	20160	16711	11141	8754	6685	5570	4377	3342	2785	2387	2188	1671	FEED	458	665	802	769	762	742	802	827	812	802	824	821	812		
				Vc	80	95	105	105	110	105	105	110	105	105	110	105	105	110	105	fz	0.006	0.011	0.016	0.023	0.029	0.037	0.048	0.063	0.081	0.096	0.115	0.125	0.162	RPM	25465	20160	16711	11141	8754	6685	5570	4377	3342	2785	2387	2188	1671	FEED	458	665	802	769	762	742	802	827	812	802	824	821
H	40	Chilled Cast Iron	0.1D	1.0D	Vc	30	35	40	45	50	50	55	55	55	55	55	fz	0.002	0.004	0.006	0.009	0.019	0.024	0.031	0.038	0.038	0.037	0.037	0.038	0.037	RPM	9549	7427	6366	4775	3979	3183	2918	2188	1751	1459	1251	1194	875	FEED	57	89	115	129	227	229	271	249	200	162	139	136	97</		

G9432, G9G50, G9A69, G9448, G9540, G9449, G9G51, G9453 SERIES 4 FLUTE - SIDE CUTTING

Vc = m/min.
 fz = mm/tooth
 RPM = rev./min.
 FEED = mm/min.

CBN END MILLS

i-Xmill END MILLS

i-SMART MODULAR END MILLS

X5070 END MILLS

4G MILL END MILLS

X-POWER PRO END MILLS

TitaNox-POWER END MILLS

JET-POWER END MILLS

V7 PLUS END MILLS

ALU-POWER HPC END MILLS

ALU-POWER END MILLS

D-POWER GRAPHITE END MILLS

D-POWER CFRP END MILLS

ROUTERS

CRX S END MILLS

K-2 END MILLS

ONLY ONE COATED PM60 END MILLS

TANK-POWER END MILLS

GENERAL HSS END MILLS

MILLING CUTTERS

TECHNICAL DATA

TECHNICAL DATA

ISO	VDI 3323	Material Description	Ae	Ap	Parameter	Mill Diameter (Ø)															
						1.0	1.5	2.0	3.0	4.0	5.0	6.0	8.0	10.0	12.0	14.0	16.0	20.0			
P	1-4	Non-alloy steel	0.1D	1.0D	Vc	55	55	60	70	80	85	90	90	85	90	90	95	90			
					fz	0.002	0.005	0.006	0.009	0.019	0.024	0.029	0.043	0.047	0.047	0.047	0.047	0.047	0.047	0.047	
	RPM		17507	11671	9549	7427	6366	5411	4775	3581	2706	2387	2046	1890	1432						
	FEED		140	233	229	267	484	519	554	616	509	449	385	355	269						
	5	0.1D	1.0D	Vc	30	35	40	45	50	50	55	55	55	55	60	55					
				fz	0.002	0.004	0.006	0.009	0.019	0.024	0.031	0.038	0.038	0.037	0.038	0.037	0.038				
6-7	Low alloy steel	0.1D	1.0D	Vc	55	55	60	70	80	85	90	90	85	90	90	95	90				
				fz	0.002	0.005	0.006	0.009	0.019	0.024	0.029	0.043	0.047	0.047	0.047	0.047	0.047	0.047			
RPM		17507	11671	9549	7427	6366	5411	4775	3581	2706	2387	2046	1890	1432							
FEED		140	233	229	267	484	519	554	616	509	449	385	355	269							
8-9	0.1D	1.0D	Vc	30	35	40	45	50	50	55	55	55	55	60	55						
			fz	0.002	0.004	0.006	0.009	0.019	0.024	0.031	0.038	0.038	0.037	0.038	0.037	0.038					
10	High alloyed steel, and tool steel	0.1D	1.0D	Vc	55	55	60	70	80	85	90	90	85	90	90	95	90				
				fz	0.002	0.005	0.006	0.009	0.019	0.024	0.029	0.043	0.047	0.047	0.047	0.047	0.047	0.047			
RPM		17507	11671	9549	7427	6366	5411	4775	3581	2706	2387	2046	1890	1432							
FEED		140	233	229	267	484	519	554	616	509	449	385	355	269							
11.1 - 11.2	0.1D	1.0D	Vc	30	35	40	45	50	50	55	55	55	55	60	55						
			fz	0.002	0.004	0.006	0.009	0.019	0.024	0.031	0.038	0.038	0.037	0.038	0.037	0.038					
M	14.1	Stainless steel	0.1D	1.0D	Vc	25	35	35	35	40	40	45	45	45	45	45	50	45			
					fz	0.002	0.004	0.006	0.009	0.018	0.024	0.029	0.042	0.044	0.045	0.045	0.045	0.045	0.046		
K	15-20	Grey cast iron Nodular cast iron Malleable cast iron	0.1D	1.5D	Vc	60	55	60	55	60	55	55	55	60	55	55	55	55			
					fz	0.008	0.013	0.017	0.026	0.035	0.044	0.065	0.093	0.116	0.155	0.182	0.22	0.288			
N	21~22	Aluminum-wrought alloy	0.1D	1.5D	Vc	140	130	140	145	140	145	145	145	145	140	145	145	140			
					fz	0.006	0.011	0.015	0.021	0.03	0.036	0.047	0.063	0.078	0.095	0.108	0.125	0.163			
N	23~25	Aluminum-cast, alloyed	0.1D	1.5D	Vc	140	130	140	145	140	145	145	145	145	140	145	145	140			
					fz	0.006	0.011	0.015	0.021	0.03	0.036	0.047	0.063	0.078	0.095	0.108	0.125	0.163			
N	26-28	Copper and Copper Alloys (Bronze / Brass)	0.1D	1.5D	Vc	80	95	105	105	110	105	105	110	105	105	110	105	105			
					fz	0.006	0.011	0.016	0.024	0.029	0.038	0.048	0.063	0.081	0.096	0.115	0.125	0.162			
N	29.1	Non Metallic Materials	0.1D	1.5D	Vc	80	95	105	105	110	105	105	110	105	105	110	105	105			
					fz	0.006	0.011	0.016	0.024	0.029	0.038	0.048	0.063	0.081	0.096	0.115	0.125	0.162			
H	40	Chilled Cast Iron	0.1D	1.0D	Vc	30	35	40	45	50	50	55	55	55	55	60	55				
					fz	0.002	0.004	0.006	0.009	0.019	0.024	0.031	0.038	0.038	0.037	0.038	0.037	0.038			
H	40	Chilled Cast Iron	0.1D	1.0D	RPM	9549	7427	6366	4775	3979	3183	2918	2188	1751	1459	1251	1194	875			
					FEED	76	119	153	172	302	306	362	333	266	216	190	177	133			

※ The FEED, in long & extra long types, should be reduced by around 50%

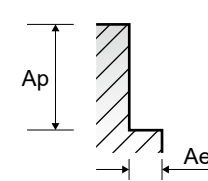



RECOMMENDED CUTTING CONDITIONS EMPFOHLENE SCHNEIDPARAMETER

HSS

CBN
END MILLS

i-Xmill
END MILLS

i-SMART
MODULAR
END MILLS

X5070
END MILLS

4G MILL
END MILLS

X-POWER
PRO
END MILLS

TitaNox-
POWER
END MILLS

JET-POWER
END MILLS

V7 PLUS
END MILLS

ALU-POWER
HPC
END MILLS

ALU-
POWER
END MILLS

D-POWER
GRAPHITE
END MILLS

D-POWER
CFRP
END MILLS

ROUTERS

CRX S
END MILLS

K-2
END MILLS

ONLY ONE
COATED PM60
END MILLS

TANK-
POWER
END MILLS

GENERAL
HSS
END MILLS

MILLING
CUTTERS

TECHNICAL
DATA

G9F45, G9F46 SERIES

4&6 FLUTE - SIDE CUTTING

Vc = m/min.
fz = mm/tooth
RPM = rev./min.
FEED = mm/min.

ISO	VDI 3323	Material Description	Ae	Ap	Parameter	Mill Diameter (Ø)													
						3.0	4.0	5.0	6.0	8.0	10.0	12.0	14.0	16.0	18.0	20.0			
P	1-4	Non-alloy steel	0.05D	1.5D	Vc	82	83	98	98	97	97	99	98	98	97	97			
					fz	0.024	0.033	0.025	0.03	0.045	0.045	0.053	0.058	0.062	0.065	0.069			
	RPM				8700	6605	6239	5199	3860	3088	2626	2228	1950	1715	1544				
	FEED				835	872	936	936	1042	834	835	775	725	669	639				
	Vc				54	55	65	65	65	64	66	66	65	65	64				
	fz				0.024	0.033	0.027	0.03	0.038	0.045	0.053	0.057	0.062	0.066	0.07				
	5	Low alloy steel	0.03D	1.5D	RPM	5730	4377	4138	3448	2586	2037	1751	1501	1293	1149	1019			
					FEED	550	578	670	621	590	550	557	513	481	455	428			
	Vc				82	83	98	98	97	97	99	98	98	97	97				
	fz				0.024	0.033	0.025	0.03	0.045	0.045	0.053	0.058	0.062	0.065	0.069				
	RPM				8700	6605	6239	5199	3860	3088	2626	2228	1950	1715	1544				
	FEED				835	872	936	936	1042	834	835	775	725	669	639				
6-7	High alloyed steel, and tool steel	0.05D	1.5D	Vc	54	55	65	65	65	64	66	66	65	65	64				
				fz	0.024	0.033	0.027	0.03	0.038	0.045	0.053	0.057	0.062	0.066	0.07				
RPM				5730	4377	4138	3448	2586	2037	1751	1501	1293	1149	1019					
FEED				550	578	670	621	590	550	557	513	481	455	428					
8-9				Grey cast iron Nodular cast iron Malleable cast iron	0.05D	1.5D	Vc	82	83	98	98	97	97	99	98	98	97	97	
							fz	0.024	0.033	0.025	0.03	0.045	0.045	0.053	0.058	0.062	0.065	0.069	
RPM	8700	6605	6239				5199	3860	3088	2626	2228	1950	1715	1544					
FEED	835	872	936				936	1042	834	835	775	725	669	639					
10	Hardened steel	0.03D	1.5D				Vc	54	55	65	65	65	64	66	66	65	65	64	
							fz	0.024	0.033	0.027	0.03	0.038	0.045	0.053	0.057	0.062	0.066	0.07	
RPM				5730	4377	4138	3448	2586	2037	1751	1501	1293	1149	1019					
FEED				550	578	670	621	590	550	557	513	481	455	428					
11.1-11.2				Chilled Cast Iron	0.03D	1.5D	Vc	82	83	98	98	97	97	99	98	98	97	97	
							fz	0.024	0.033	0.025	0.03	0.045	0.045	0.053	0.058	0.062	0.065	0.069	
RPM	8700	6605	6239				5199	3860	3088	2626	2228	1950	1715	1544					
FEED	835	872	936				936	1042	834	835	775	725	669	639					
K 15-20	Hardened Cast Iron	0.03D	1.5D				Vc	54	55	65	65	65	64	66	66	65	65	64	
							fz	0.024	0.033	0.027	0.03	0.038	0.045	0.053	0.057	0.062	0.066	0.07	
RPM				5730	4377	4138	3448	2586	2037	1751	1501	1293	1149	1019					
FEED				550	578	670	621	590	550	557	513	481	455	428					
H				38.1	Hardened steel	0.03D	1.5D	Vc	45	45	50	50	50	50	50	50	50	50	50
								fz	0.018	0.025	0.02	0.023	0.029	0.033	0.029	0.041	0.046	0.05	0.052
	RPM	4775	3581					3183	2653	1989	1592	1326	1137	995	884	796			
	38.2~39.1	Chilled Cast Iron	0.03D	1.5D				FEED	344	358	382	366	346	315	231	280	275	265	248
								Vc	35	35	40	40	40	40	40	40	40	40	41
								fz	0.014	0.02	0.016	0.018	0.023	0.027	0.031	0.034	0.037	0.039	0.042
39.2	Hardened steel				0.02D	1D	RPM	3714	2785	2546	2122	1592	1273	1061	909	796	707	653	
							FEED	208	223	244	229	220	206	197	186	177	166	164	
							Vc	54	55	65	65	65	64	66	66	65	65	64	
40		Hardened steel	0.03D	1.5D			fz	0.024	0.033	0.027	0.03	0.038	0.045	0.053	0.057	0.062	0.066	0.07	
							RPM	5730	4377	4138	3448	2586	2037	1751	1501	1293	1149	1019	
							FEED	550	578	670	621	590	550	557	513	481	455	428	
41	Hardened steel				0.03D	1.5D	Vc	45	45	50	50	50	50	50	50	50	50	50	
							fz	0.018	0.025	0.02	0.023	0.029	0.033	0.029	0.041	0.046	0.05	0.052	
							RPM	4775	3581	3183	2653	1989	1592	1326	1137	995	884	796	
FEED		344	358	382			366	346	315	231	280	275	265	248					

※ The FEED, in long & extra long types, should be reduced by around 50%

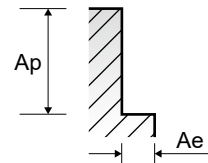

G9A42 SERIES

MULTI FLUTE ROUGHING - SIDE CUTTING

Vc = m/min.
fz = mm/tooth
RPM = rev./min.
FEED = mm/min.

ISO	VDI 3323	Material Description	Ae	Ap	Parameter	Mill Diameter (Ø)									
						6.0	8.0	10.0	12.0	14.0	16.0	18.0	20.0	25.0	
P	1-4	Non-alloy steel	0.3D	1.5D	Vc	250	250	245	255	255	255	250	260	285	
					fz	0.05	0.067	0.063	0.075	0.088	0.1	0.112	0.112	0.1	
	RPM	13263	9947	7799	6764	5798	5073	4421	4138	3629					
	FEED	1989	1999	1965	2029	2041	2029	1981	1854	1814					
	5	Non-alloy steel	0.3D	1.5D	Vc	200	195	205	190	195	205	210	190	210	
					fz	0.022	0.023	0.028	0.033	0.04	0.04	0.041	0.039	0.039	
	RPM	10610	7759	6525	5040	4434	4078	3714	3024	2674					
	FEED	700	535	731	665	709	653	609	472	521					
	6-7	Low alloy steel	0.3D	1.5D	Vc	250	250	245	255	255	255	250	260	285	
					fz	0.05	0.067	0.063	0.075	0.088	0.1	0.112	0.112	0.1	
RPM	13263	9947	7799	6764	5798	5073	4421	4138	3629						
FEED	1989	1999	1965	2029	2041	2029	1981	1854	1814						
8-9	Low alloy steel	0.3D	1.5D	Vc	200	195	205	190	195	205	210	190	210		
				fz	0.022	0.023	0.028	0.033	0.04	0.04	0.041	0.039	0.039		
RPM	10610	7759	6525	5040	4434	4078	3714	3024	2674						
FEED	700	535	731	665	709	653	609	472	521						
10	High alloyed steel, and tool steel	0.3D	1.5D	Vc	250	250	245	255	255	255	250	260	285		
				fz	0.05	0.067	0.063	0.075	0.088	0.1	0.112	0.112	0.1		
RPM	13263	9947	7799	6764	5798	5073	4421	4138	3629						
FEED	1989	1999	1965	2029	2041	2029	1981	1854	1814						
11.1 - 11.2	High alloyed steel, and tool steel	0.3D	1.5D	Vc	200	195	205	190	195	205	210	190	210		
				fz	0.022	0.023	0.028	0.033	0.04	0.04	0.041	0.039	0.039		
RPM	10610	7759	6525	5040	4434	4078	3714	3024	2674						
FEED	700	535	731	665	709	653	609	472	521						
M	14.1	Stainless steel	0.05D	1.0D	Vc	135	135	135	135	135	140	130	130	145	
fz	0.022	0.022	0.028	0.034	0.039	0.038	0.039	0.038	0.038	0.038					
RPM	7162	5371	4297	3581	3069	2785	2299	2069	1846						
FEED	473	355	481	487	479	423	359	314	351						
S	31-35	Heat Resistant Super Alloys	0.05D	1.0D	Vc	40	40	35	40	35	35	35	35	40	
					fz	0.026	0.024	0.036	0.04	0.037	0.032	0.038	0.041	0.06	
RPM	2122	1592	1114	1061	796	696	619	557	509						
FEED	166	115	160	170	118	89	94	91	153						
H	40	Chilled Cast Iron	0.3D	1.5D	Vc	200	195	205	190	195	205	210	190	210	
					fz	0.022	0.023	0.028	0.033	0.04	0.04	0.041	0.039	0.039	
RPM	10610	7759	6525	5040	4434	4078	3714	3024	2674						
FEED	700	535	731	665	709	653	609	472	521						

※ The FEED, in long & extra long types, should be reduced by around 50%

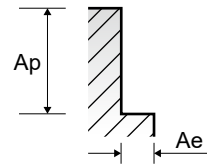

G9400 SERIES

2 FLUTE DRILL MILLS - CHAMFERING

Vc = m/min.
fz = mm/tooth
RPM = rev./min.
FEED = mm/min.

ISO	VDI 3323	Material Description	Parameter	Mill Diameter (Ø)										
				3.0	4.0	5.0	6.0	8.0	10.0	12.0	16.0	20.0		
P	1-2	Non-alloy steel	Vc	60	65	65	60	60	65	70	70	85		
			fz	0.025	0.031	0.04	0.052	0.071	0.083	0.1	0.125	0.137		
			RPM	6366	5173	4138	3183	2387	2069	1857	1393	1353		
			FEED	318	321	331	331	339	343	371	348	371		
			3-4	Vc	45	55	55	55	55	55	60	65	65	
				fz	0.023	0.027	0.036	0.043	0.058	0.073	0.091	0.105	0.14	
				RPM	4775	4377	3501	2918	2188	1751	1592	1293	1035	
				FEED	220	236	252	251	254	256	290	272	290	
			5	Vc	40	45	45	40	40	50	50	50	55	
				fz	0.023	0.028	0.035	0.044	0.06	0.066	0.083	0.115	0.134	
				RPM	4244	3581	2865	2122	1592	1592	1326	995	875	
				FEED	195	201	201	187	191	210	220	229	235	
	6	Low alloy steel	Vc	60	65	65	60	60	65	70	70	85		
			fz	0.025	0.031	0.04	0.052	0.071	0.083	0.1	0.125	0.137		
			RPM	6366	5173	4138	3183	2387	2069	1857	1393	1353		
			FEED	318	321	331	331	339	343	371	348	371		
			7	Vc	45	55	55	55	55	55	60	65	65	
				fz	0.023	0.027	0.036	0.043	0.058	0.073	0.091	0.105	0.14	
				RPM	4775	4377	3501	2918	2188	1751	1592	1293	1035	
				FEED	220	236	252	251	254	256	290	272	290	
			8-9	Vc	40	45	45	40	40	50	50	50	55	
				fz	0.023	0.028	0.035	0.044	0.06	0.066	0.083	0.115	0.134	
				RPM	4244	3581	2865	2122	1592	1592	1326	995	875	
				FEED	195	201	201	187	191	210	220	229	235	
	10	High alloyed steel, and tool steel	Vc	60	65	65	60	60	65	70	70	85		
			fz	0.025	0.031	0.04	0.052	0.071	0.083	0.1	0.125	0.137		
			RPM	6366	5173	4138	3183	2387	2069	1857	1393	1353		
			FEED	318	321	331	331	339	343	371	348	371		
11.1			Vc	40	45	45	40	40	50	50	50	55		
			fz	0.023	0.028	0.035	0.044	0.06	0.066	0.083	0.115	0.134		
			RPM	4244	3581	2865	2122	1592	1592	1326	995	875		
			FEED	195	201	201	187	191	210	220	229	235		
M			14.1	Stainless steel	Vc	30	35	40	35	35	40	40	40	45
					fz	0.021	0.025	0.029	0.037	0.055	0.064	0.078	0.11	0.122
					RPM	3183	2785	2546	1857	1393	1273	1061	796	716
					FEED	134	139	148	137	153	163	166	175	175
N	21~22	Aluminum-wrought alloy	Vc	145	160	150	150	155	175	185	195	195		
			fz	0.025	0.032	0.045	0.057	0.075	0.085	0.1	0.134	0.175		
			RPM	15385	12732	9549	7958	6167	5570	4907	3879	3104		
			FEED	769	815	859	907	925	947	981	1040	1086		
	23~25	Aluminum-cast, alloyed	Vc	145	160	150	150	155	175	185	195	195		
			fz	0.025	0.032	0.045	0.057	0.075	0.085	0.1	0.134	0.175		
			RPM	15385	12732	9549	7958	6167	5570	4907	3879	3104		
			FEED	769	815	859	907	925	947	981	1040	1086		

※ The FEED, in long & extra long types, should be reduced by around 50%

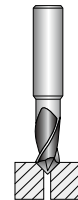

G9400 SERIES

2 FLUTE DRILL MILLS - CHAMFERING & SIDE CUTTING

Vc = m/min.
fz = mm/tooth
RPM = rev./min.
FEED = mm/min.

ISO	VDI 3323	Material Description	Parameter	Mill Diameter (Ø)								
				3.0	4.0	5.0	6.0	8.0	10.0	12.0	16.0	20.0
P	1-2	Non-alloy steel	Vc	80	85	85	80	80	90	95	90	95
			fz	0.008	0.01	0.013	0.018	0.025	0.03	0.037	0.054	0.063
			RPM	8488	6764	5411	4244	3183	2865	2520	1790	1512
	FEED		136	135	141	153	159	172	186	193	191	
	Vc		50	55	55	55	55	55	60	65	60	
	fz		0.008	0.01	0.013	0.018	0.024	0.03	0.041	0.05	0.064	
	3-4	Non-alloy steel	RPM	5305	4377	3501	2918	2188	1751	1592	1293	955
			FEED	85	88	91	105	105	105	131	129	122
			Vc	45	50	50	50	45	55	55	55	55
	fz		0.008	0.009	0.012	0.017	0.025	0.027	0.036	0.046	0.06	
	RPM		4775	3979	3183	2653	1790	1751	1459	1094	875	
	FEED		76	72	76	90	90	95	105	101	105	
5	Non-alloy steel	Vc	80	85	85	80	80	90	95	90	95	
		fz	0.008	0.01	0.013	0.018	0.025	0.03	0.037	0.054	0.063	
		RPM	8488	6764	5411	4244	3183	2865	2520	1790	1512	
FEED		136	135	141	153	159	172	186	193	191		
Vc		50	55	55	55	55	55	60	65	60		
fz		0.008	0.01	0.013	0.018	0.024	0.03	0.041	0.05	0.064		
6	Low alloy steel	RPM	5305	4377	3501	2918	2188	1751	1592	1293	955	
		FEED	85	88	91	105	105	105	131	129	122	
		Vc	45	50	50	50	45	55	55	55	55	
fz		0.008	0.009	0.012	0.017	0.025	0.027	0.036	0.046	0.06		
RPM		4775	3979	3183	2653	1790	1751	1459	1094	875		
FEED		76	72	76	90	90	95	105	101	105		
7	Low alloy steel	Vc	80	85	85	80	80	90	95	90	95	
		fz	0.008	0.01	0.013	0.018	0.025	0.03	0.037	0.054	0.063	
		RPM	8488	6764	5411	4244	3183	2865	2520	1790	1512	
FEED		136	135	141	153	159	172	186	193	191		
Vc		50	55	55	55	55	55	60	65	60		
fz		0.008	0.01	0.013	0.018	0.024	0.03	0.041	0.05	0.064		
8-9	Low alloy steel	RPM	5305	4377	3501	2918	2188	1751	1592	1293	955	
		FEED	85	88	91	105	105	105	131	129	122	
		Vc	45	50	50	50	45	55	55	55	55	
fz		0.008	0.009	0.012	0.017	0.025	0.027	0.036	0.046	0.06		
RPM		4775	3979	3183	2653	1790	1751	1459	1094	875		
FEED		76	72	76	90	90	95	105	101	105		
10	High alloyed steel, and tool steel	Vc	80	85	85	80	80	90	95	90	95	
		fz	0.008	0.01	0.013	0.018	0.025	0.03	0.037	0.054	0.063	
		RPM	8488	6764	5411	4244	3183	2865	2520	1790	1512	
FEED		136	135	141	153	159	172	186	193	191		
Vc		45	50	50	50	45	55	55	55	55		
fz		0.008	0.009	0.012	0.017	0.025	0.027	0.036	0.046	0.06		
11.1	High alloyed steel, and tool steel	RPM	4775	3979	3183	2653	1790	1751	1459	1094	875	
		FEED	76	72	76	90	90	95	105	101	105	
		Vc	30	35	40	35	40	45	45	45	40	
fz		0.008	0.01	0.013	0.018	0.024	0.027	0.036	0.046	0.069		
RPM		3183	2785	2546	1857	1592	1432	1194	895	637		
FEED		51	56	66	67	76	77	86	82	88		
M	14.1	Stainless steel	Vc	185	210	210	205	205	225	230	230	230
			fz	0.008	0.01	0.013	0.019	0.03	0.037	0.045	0.05	0.064
			RPM	19629	16711	13369	10876	8157	7162	6101	4576	3661
FEED			314	334	348	413	489	530	549	458	469	
Vc			185	210	210	205	205	225	230	230	230	
fz			0.008	0.01	0.013	0.019	0.03	0.037	0.045	0.05	0.064	
N	21~22	Aluminum-wrought alloy	RPM	19629	16711	13369	10876	8157	7162	6101	4576	3661
			FEED	314	334	348	413	489	530	549	458	469
			Vc	185	210	210	205	205	225	230	230	230
fz			0.008	0.01	0.013	0.019	0.03	0.037	0.045	0.05	0.064	
RPM			19629	16711	13369	10876	8157	7162	6101	4576	3661	
FEED			314	334	348	413	489	530	549	458	469	
S	36-37	Titanium Alloys	Vc	30	35	40	35	40	45	45	45	40
			fz	0.008	0.01	0.013	0.018	0.024	0.027	0.036	0.046	0.069
			RPM	3183	2785	2546	1857	1592	1432	1194	895	637
FEED			51	56	66	67	76	77	86	82	88	

※ The FEED, in long & extra long types, should be reduced by around 50%

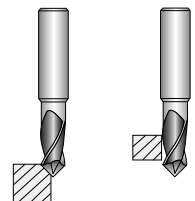

G9400 SERIES
2 FLUTE DRILL MILLS - V-GROOVING

Vc = m/min.
fz = mm/tooth
RPM = rev./min.
FEED = mm/min.

ISO	VDI 3323	Material Description	Parameter	Mill Diameter (Ø)								
				3.0	4.0	5.0	6.0	8.0	10.0	12.0	16.0	20.0
P	1-2	Non-alloy steel	Vc	80	85	85	80	80	90	95	100	95
			fz	0.005	0.006	0.008	0.01	0.014	0.016	0.018	0.023	0.029
			RPM	8488	6764	5411	4244	3183	2865	2520	1989	1512
	FEED		85	81	87	85	89	92	91	92	88	
	3-4		Vc	55	60	55	55	55	55	55	65	60
			fz	0.004	0.004	0.006	0.007	0.012	0.014	0.02	0.022	0.028
			RPM	5836	4775	3501	2918	2188	1751	1459	1293	955
	FEED		47	38	42	41	53	49	58	57	53	
	5		Vc	45	50	50	50	45	55	55	55	55
		fz	0.004	0.004	0.006	0.008	0.014	0.015	0.018	0.023	0.03	
		RPM	4775	3979	3183	2653	1790	1751	1459	1094	875	
	FEED	38	32	38	42	50	53	53	50	53		
	6	Vc	80	85	85	80	80	90	95	100	95	
		fz	0.005	0.006	0.008	0.01	0.014	0.016	0.018	0.023	0.029	
		RPM	8488	6764	5411	4244	3183	2865	2520	1989	1512	
	FEED	85	81	87	85	89	92	91	92	88		
	7	Vc	55	60	55	55	55	55	55	65	60	
		fz	0.004	0.004	0.006	0.007	0.012	0.014	0.02	0.022	0.028	
		RPM	5836	4775	3501	2918	2188	1751	1459	1293	955	
	FEED	47	38	42	41	53	49	58	57	53		
	8-9	Vc	45	50	50	50	45	55	55	55	55	
		fz	0.004	0.004	0.006	0.008	0.014	0.015	0.018	0.023	0.03	
		RPM	4775	3979	3183	2653	1790	1751	1459	1094	875	
	FEED	38	32	38	42	50	53	53	50	53		
10	Vc	80	85	85	80	80	90	95	100	95		
	fz	0.005	0.006	0.008	0.01	0.014	0.016	0.018	0.023	0.029		
	RPM	8488	6764	5411	4244	3183	2865	2520	1989	1512		
FEED	85	81	87	85	89	92	91	92	88			
11.1	Vc	45	50	50	50	45	55	55	55	55		
	fz	0.004	0.004	0.006	0.008	0.014	0.015	0.018	0.023	0.03		
	RPM	4775	3979	3183	2653	1790	1751	1459	1094	875		
FEED	38	32	38	42	50	53	53	50	53			
M	14.1	Stainless steel	Vc	30	35	40	35	40	45	45	45	40
			fz	0.004	0.005	0.006	0.008	0.01	0.011	0.013	0.019	0.028
			RPM	3183	2785	2546	1857	1592	1432	1194	895	637
			FEED	25	28	31	30	32	32	31	34	36
N	21~22	Aluminum-wrought alloy	Vc	185	210	210	205	205	220	230	230	230
			fz	0.008	0.01	0.013	0.016	0.022	0.026	0.03	0.041	0.052
			RPM	19629	16711	13369	10876	8157	7003	6101	4576	3661
	FEED	314	334	348	348	359	364	366	375	381		
	23~25	Aluminum-cast, alloyed	Vc	185	210	210	205	205	220	230	230	230
			fz	0.008	0.01	0.013	0.016	0.022	0.026	0.03	0.041	0.052
RPM			19629	16711	13369	10876	8157	7003	6101	4576	3661	
FEED	314	334	348	348	359	364	366	375	381			
S	36-37	Titanium Alloys	Vc	30	35	40	35	40	45	45	45	40
			fz	0.004	0.005	0.006	0.008	0.01	0.011	0.013	0.019	0.028
			RPM	3183	2785	2546	1857	1592	1432	1194	895	637
			FEED	25	28	31	30	32	32	31	34	36

※ The FEED, in long & extra long types, should be reduced by around 50%

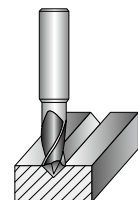



Global Cutting Tool Leader **YG-1**



MILLING



Leading Through Innovation



HSS PM60



ONLY ONE COATED PM60 END MILLS

Only One, beschichtete Pulvermetall PM60 Schaftfräser

- Perfect Solution of Carbide Chipping under Vibrations
- Perfekte Lösung bei Zerspanung unter Vibrationen

SELECTION GUIDE



SERIES	GYG77 GYF97	GYG72 GYF99	GYG01
FLUTE	2	2	3
HELIX ANGLE	30°	30°	30°
CUTTING EDGE SHAPE	BALL NOSE	SQUARE	SQUARE
SIZE MIN	R0.5	D1.0	D1.0
SIZE MAX	R12.5	D25.0	D25.0
PAGE	618	619	620

COATED PM60

ONLY ONE END MILLS

Perfect solution to protect Carbide chipping problems under vibrations



Please visit globalyg1.com/mat for material search

◎ : Excellent ○ : Good

Recommended cutting conditions : P 628



- CBN END MILLS
- i-Xmill END MILLS
- i-SMART MODULAR END MILLS
- X5070 END MILLS
- 4G MILL END MILLS
- X-POWER PRO END MILLS
- TitaNox-POWER END MILLS
- JET-POWER END MILLS
- V7 PLUS END MILLS
- ALU-POWER HPC END MILLS
- ALU-POWER END MILLS
- D-POWER GRAPHITE END MILLS
- D-POWER CFRP END MILLS
- ROUTERS
- CRX S END MILLS
- K-2 END MILLS
- ONLY ONE COATED PM60 END MILLS
- TANK-POWER END MILLS
- GENERAL HSS END MILLS
- MILLING CUTTERS
- TECHNICAL DATA

ISO	VDI 3323	Material Description	Composition / Structure / Heat Treatment	HB	HRc	GYG77 GYF97	GYG72 GYF99	GYG01	
P	1	Non-alloy steel	About 0.15% C Annealed	125		◎	◎	◎	
	2		About 0.45% C Annealed	190	13	◎	◎	◎	
	3		About 0.45% C Quenched & Tempered	250	25	◎	◎	◎	
	4		About 0.75% C Annealed	270	28	◎	◎	◎	
	5		About 0.75% C Quenched & Tempered	300	32	◎	◎	◎	
	6	Low alloy steel	Annealed	180	10	◎	◎	◎	
	7		Quenched & Tempered	275	29	◎	◎	◎	
	8		Quenched & Tempered	300	32	◎	◎	◎	
	9		Quenched & Tempered	350	38	○	○	○	
	10		High alloyed steel, and tool steel	Annealed	200	15	◎	◎	◎
	11			Quenched & Tempered	325	35	○	○	○
M	12	Stainless steel	Ferritic / Martensitic Annealed	200	15	◎	◎	◎	
	13		Martensitic Quenched & Tempered	240	23	◎	◎	◎	
	14		Austenitic	180	10	◎	◎	◎	
K	15	Grey cast iron	Pearlitic / ferritic	180	10	◎	◎	◎	
	16		Pearlitic (Martensitic)	260	26	◎	◎	◎	
	17	Nodular cast iron	Ferritic	160	3	◎	◎	◎	
	18		Pearlitic	250	25	◎	◎	◎	
	19		Ferritic	130		◎	◎	◎	
20	Malleable cast iron	Pearlitic	230	21	◎	◎	◎		
N	21	Aluminum-wrought alloy	Not Curable	60					
	22		Curable Hardened	100					
	23	Aluminum-cast, alloyed	≤ 12% Si, Not Curable	75					
	24		≤ 12% Si, Curable Hardened	90					
	25		> 12% Si, Not Curable	130					
	26	Copper and Copper Alloys (Bronze / Brass)	Cutting Alloys, PB>1%	110		○	○	○	
	27		CuZn, CuSnZn (Brass)	90		○	○	○	
	28		CuSn, lead-free copper and electrolytic copper	100		○	○	○	
	29	Non Metallic Materials	Duroplastic, Fiber Reinforced Plastic						
	30		Rubber, Wood, etc.						
S	31	Heat Resistant Super Alloys	Fe Based Annealed	200	15				
	32		Cured	280	30				
	33		Annealed	250	25				
	34		Ni or Co Based Cured	350	38				
	35	Cast	320	34					
	36	Titanium Alloys	Pure Titanium	400 Rm					
	37		Alpha + Beta Alloys Hardened	1050 Rm					
H	38	Hardened steel	Hardened	550	55				
	39		Hardened	630	60				
	40	Chilled Cast Iron	Cast	400	42	○	○	○	
	41	Hardened Cast Iron	Hardened	550	55				

GYG74 GYF96	GYG52	GYG76 GYG02	GYF95	GYF94	GYF98	GYG03
4	4	4	Multi Flute	Multi Flute	Multi Flute	Multi Flute
30°	35°/37°	30°	4F: 44°/45° 5F: 44°/44.5°/45°	30°	30°	30°
SQUARE	SQUARE	SQUARE	CORNER RADIUS ROUGHING	ROUGHING	ROUGHING	ROUGHING
D1.0	D3.0	D2.0	D6.0	D6.0	D6.0	D6.0
D25.0	D25.0	D25.0	D25.0	D25.0	D25.0	D25.0
621	622	623	624	625	626	627
SHORT LENGTH (Center Cut)	SHORT LENGTH (Center Cut)	LONG LENGTH (Center Cut)	SHORT LENGTH (Center Cut)	SHORT LENGTH (Center Cut)	LONG LENGTH (Center Cut)	SHORT LENGTH (Center Cut)
Y-Coating	Y-Coating	Y-Coating	Y-Coating	Y-Coating	Y-Coating	Y-Coating

⊙	⊙	⊙	⊙	⊙	⊙	⊙	1
⊙	⊙	⊙	⊙	⊙	⊙	⊙	2
⊙	⊙	⊙	⊙	⊙	⊙	⊙	3
⊙	⊙	⊙	⊙	⊙	⊙	⊙	4
⊙	⊙	⊙	⊙	⊙	⊙	⊙	5
⊙	⊙	⊙	⊙	⊙	⊙	⊙	6 P
⊙	⊙	⊙	⊙	⊙	⊙	⊙	7
⊙	⊙	⊙	⊙	⊙	⊙	⊙	8
○	○	○	○	○	○	○	9
⊙	⊙	⊙	⊙	⊙	⊙	⊙	10
○	○	○	○	○	○	○	11
⊙	⊙	⊙	⊙	⊙	⊙	⊙	12
⊙	⊙	⊙	⊙	⊙	⊙	⊙	13 M
⊙	⊙	⊙	⊙	⊙	⊙	⊙	14
⊙	⊙	⊙	⊙	⊙	⊙	⊙	15
⊙	⊙	⊙	⊙	⊙	⊙	⊙	16
⊙	⊙	⊙	⊙	⊙	⊙	⊙	17 K
⊙	⊙	⊙	⊙	⊙	⊙	⊙	18
⊙	⊙	⊙	⊙	⊙	⊙	⊙	19
⊙	⊙	⊙	⊙	⊙	⊙	⊙	20
							21
							22
							23
							24
							25
○	○	○	○	○	○	○	26 N
○	○	○	○	○	○	○	27
○	○	○	○	○	○	○	28
							29
							30
							31
							32
							33
							34 S
							35
							36
							37
							38
○	○	○	○	○	○	○	39 H
							40
							41

CBN
END MILLS

i-Xmill
END MILLS

i-SMART
MODULAR
END MILLS

X5070
END MILLS

4G MILL
END MILLS

X-POWER
PRO
END MILLS

TitaNox-
POWER
END MILLS

JET-POWER
END MILLS

V7 PLUS
END MILLS

ALU-POWER
HPC
END MILLS

ALU-
POWER
END MILLS

D-POWER
GRAPHITE
END MILLS

D-POWER
CFRP
END MILLS

ROUTERS

CRX S
END MILLS

K-2
END MILLS

ONLY ONE
COATED PM60
END MILLS

TANK-
POWER
END MILLS

GENERAL
HSS
END MILLS

MILLING
CUTTERS

TECHNICAL
DATA



PM60, 2 FLUTE BALL NOSE SHORT LENGTH

- **PM60, 2 Schneiden, Stirnradius kurz**
- **Revêtue YG-AlCrN - PM60, 2 dents, série courte, hémisphérique**
- **Rivestita PM60, 2 TAGLIENTE SERIE CORTA SEMISFERICA**

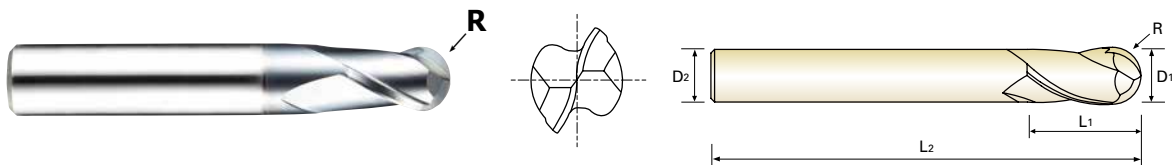

Unit : mm

EDP No.		Radius of Ball Nose	Mill Diameter	Shank Diameter	Length of Cut	Overall Length
PLAIN	FLAT	R(±0.02)	D1	D2	L1	L2
GYG77010	GYF97010	R0.5	1.0	6	2.5	47
GYG77020	GYF97020	R1.0	2.0	6	4	48
GYG77030	GYF97030	R1.5	3.0	6	5	49
GYG77040	GYF97040	R2.0	4.0	6	7	51
GYG77050	GYF97050	R2.5	5.0	6	8	52
GYG77060	GYF97060	R3.0	6.0	6	8	52
GYG77070	GYF97070	R3.5	7.0	8	10	60
GYG77080	GYF97080	R4.0	8.0	8	11	61
GYG77090	GYF97090	R4.5	9.0	10	11	61
GYG77100	GYF97100	R5.0	10.0	10	13	63
GYG77120	GYF97120	R6.0	12.0	12	16	73
GYG77140	GYF97140	R7.0	14.0	12	16	73
GYG77160	GYF97160	R8.0	16.0	16	19	79
GYG77180	GYF97180	R9.0	18.0	16	19	79
GYG77200	GYF97200	R10.0	20.0	20	22	88
GYG77250	GYF97250	R12.5	25.0	25	26	102

Mill Dia. Tolerance (mm)	Shank Dia. Tolerance
0 ~ -0.03	h6

◎ : Excellent ○ : Good

ISO Material Description	P											M			K					
	Non-alloy steel					Low alloy steel				High alloyed steel, and tool steel		Stainless steel			Grey cast iron		Nodular cast iron		Malleable cast iron	
VDI 3323	1	2	3	4	5	6	7	8	9	10	11	12	13	14	15	16	17	18	19	20
HRc		13	25	28	32	10	29	32	38	15	35	15	23	10	10	26	3	25		21
HB	125	190	250	270	300	180	275	300	350	200	325	200	240	180	180	260	160	250	130	230
Recommend	◎	◎	◎	◎	◎	◎	◎	◎	◎	◎	◎	◎	◎	◎	◎	◎	◎	◎	◎	◎

ISO Material Description	N										S							H			
	Aluminum-wrought alloy		Aluminum-cast, alloyed			Copper and Copper Alloys (Bronze / Brass)			Non Metallic Materials		Heat Resistant Super Alloys					Titanium Alloys		Hardened steel	Chilled Cast Iron	Hardened Cast Iron	
VDI 3323	21	22	23	24	25	26	27	28	29	30	31	32	33	34	35	36	37	38	39	40	41
HRc											15	30	25	38	34			55	60	42	55
HB	60	100	75	90	130	110	90	100			200	280	250	350	320	400 Rm	1050 Rm	550	630	400	550
Recommend						○	○	○												○	

PM60, 2 FLUTE SHORT LENGTH

- PM60, 2 Schneiden, kurz, Zentrumschnitt
- Revêtue YG-AICrN - PM60, 2 dents, série courte (Coupe au centre)
- Rivestita PM60, 2 TAGLIENTI SERIE CORTA (Tagliente al centro)

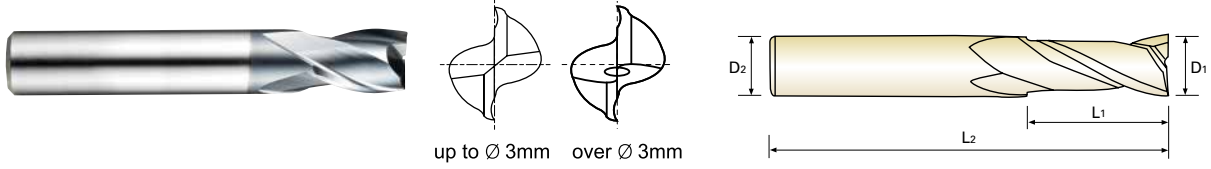

PM 60
2
30°
PLAIN
FLAT
P.629

Unit : mm

EDP No.		Mill Diameter	Shank Diameter	Length of Cut	Overall Length
PLAIN	FLAT	D1	D2	L1	L2
GYG72010	GYF99010	1.0	6	2.5	47
GYG72020	GYF99020	2.0	6	4	48
GYG72030	GYF99030	3.0	6	5	49
GYG72040	GYF99040	4.0	6	7	51
GYG72050	GYF99050	5.0	6	8	52
GYG72060	GYF99060	6.0	6	8	52
GYG72070	GYF99070	7.0	8	10	60
GYG72080	GYF99080	8.0	8	11	61
GYG72090	GYF99090	9.0	10	11	61
GYG72100	GYF99100	10.0	10	13	63
GYG72120	GYF99120	12.0	12	16	73
GYG72140	GYF99140	14.0	12	16	73
GYG72160	GYF99160	16.0	16	19	79
GYG72180	GYF99180	18.0	16	19	79
GYG72200	GYF99200	20.0	20	22	88
GYG72220	GYF99220	22.0	20	22	88
GYG72250	GYF99250	25.0	25	26	102

Mill Dia. Tolerance (mm)	Shank Dia. Tolerance
0 ~ - 0.03	h6

◎ : Excellent ○ : Good

ISO Material Description	P											M				K					
	Non-alloy steel					Low alloy steel				High alloyed steel, and tool steel		Stainless steel				Grey cast iron		Nodular cast iron		Malleable cast iron	
VDI 3323	1	2	3	4	5	6	7	8	9	10	11	12	13	14	15	16	17	18	19	20	
HRC																					
HB	125	130	250	270	300	180	275	300	350	200	325	200	240	180	180	260	160	250	130	230	
Recommend	◎	◎	◎	◎	◎	◎	◎	◎	○	◎	◎	◎	◎	◎	◎	◎	◎	◎	◎	◎	

ISO Material Description	N										S						H				
	Aluminum-wrought alloy		Aluminum-cast, alloyed			Copper and Copper Alloys (Bronze / Brass)			Non Metallic Materials		Heat Resistant Super Alloys						Titanium Alloys		Hardened steel	Chilled Cast Iron	Hardened Cast Iron
VDI 3323	21	22	23	24	25	26	27	28	29	30	31	32	33	34	35	36	37	38	39	40	41
HRC																					
HB	60	100	75	90	130	110	90	100			200	280	250	350	320	400 Rm	1050 Rm	550	630	400	550
Recommend						○	○	○													

CBN END MILLS
i-Xmill END MILLS
i-SMART MODULAR END MILLS
X5070 END MILLS
4G MILL END MILLS
X-POWER PRO END MILLS
TitaNox-POWER END MILLS
JET-POWER END MILLS
V7 PLUS END MILLS
ALU-POWER HPC END MILLS
ALU-POWER END MILLS
D-POWER GRAPHITE END MILLS
D-POWER CFRP END MILLS
ROUTERS
CRX S END MILLS
K-2 END MILLS
ONLY ONE COATED PM60 END MILLS
TANK-POWER END MILLS
GENERAL HSS END MILLS
MILLING CUTTERS
TECHNICAL DATA

PM60, 3 FLUTE SHORT LENGTH (Center Cut)

- **PM60, 3 Schneiden, kurz, Zentrumschnitt**
- **Revêtue YG-AlCrN - PM60, 3 dents, série courte (Coupe au centre)**
- **Rivestita PM60, 3 TAGLIENTI SERIE CORTA (Tagliante al centro)**

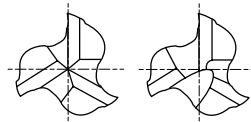

up to \varnothing 1mm over \varnothing 1mm

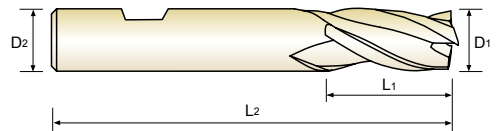

PM 60
3
30°
FLAT
p.630-631

Unit : mm

EDP No.	Mill Diameter	Shank Diameter	Length of Cut	Overall Length
	D1	D2	L1	L2
GYG01010	1.0	6	3	47
GYG01020	2.0	6	7	51
GYG01030	3.0	6	8	52
GYG01040	4.0	6	11	55
GYG01050	5.0	6	13	57
GYG01060	6.0	6	13	57
GYG01070	7.0	8	16	66
GYG01080	8.0	8	19	69
GYG01090	9.0	10	19	69
GYG01100	10.0	10	22	72
GYG01120	12.0	12	26	83
GYG01140	14.0	12	26	83
GYG01160	16.0	16	32	92
GYG01180	18.0	16	32	92
GYG01200	20.0	20	38	104
GYG01220	22.0	20	38	104
GYG01250	25.0	25	45	121

Mill Dia. Tolerance (mm)	Shank Dia. Tolerance
0 ~ -0.03	h6

◎ : Excellent ○ : Good

ISO Material Description	P Non-alloy steel					Low alloy steel				High alloyed steel, and tool steel		M Stainless steel			K Grey cast iron		Nodular cast iron		Malleable cast iron	
	1	2	3	4	5	6	7	8	9	10	11	12	13	14	15	16	17	18	19	20
VDI 3323	1	2	3	4	5	6	7	8	9	10	11	12	13	14	15	16	17	18	19	20
HRc		13	25	28	32	10	29	32	38	15	35	15	23	10	10	26	3	25		21
HB	125	190	250	270	300	180	275	300	350	200	325	200	240	180	180	260	160	250	130	230
Recommend	◎	◎	◎	◎	◎	◎	◎	◎	○	◎	○	◎	◎	◎	◎	◎	◎	◎	◎	◎

ISO Material Description	N Aluminum-wrought alloy					Aluminum-cast, alloyed		Copper and Copper Alloys (Bronze / Brass)		Non Metallic Materials	S Heat Resistant Super Alloys					Titanium Alloys		Hardened steel	Chilled Cast Iron	Hardened Cast Iron	
	21	22	23	24	25	26	27	28	29	30	31	32	33	34	35	36	37	38	39	40	41
VDI 3323	21	22	23	24	25	26	27	28	29	30	31	32	33	34	35	36	37	38	39	40	41
HRc											15	30	25	38	34			55	60	42	55
HB	60	100	75	90	130	110	90	100			200	280	250	350	320	400 Rm	1050 Rm	550	630	400	550
Recommend						○	○	○												○	

PM60, 4 FLUTE SHORT LENGTH (Center Cut)

- PM60, 4 Schneiden, kurz, Zentrumschnitt
- Revêtuë YG-AiCrN - PM60, 4 dents, série courte (Coupe au centre)
- Rivestita PM60, 4 TAGLIENTI SERIE CORTA (Tagliante al centro)









 R.632

Unit : mm

EDP No.		Mill Diameter	Shank Diameter	Length of Cut	Overall Length
PLAIN	FLAT	D1	D2	L1	L2
GYG74010	GYF96010	1.0	6	3	49
GYG74020	GYF96020	2.0	6	7	51
GYG74030	GYF96030	3.0	6	8	52
GYG74040	GYF96040	4.0	6	11	55
GYG74050	GYF96050	5.0	6	13	57
GYG74060	GYF96060	6.0	6	13	57
GYG74070	GYF96070	7.0	8	16	66
GYG74080	GYF96080	8.0	8	19	69
GYG74090	GYF96090	9.0	10	19	69
GYG74100	GYF96100	10.0	10	22	72
GYG74120	GYF96120	12.0	12	26	83
GYG74140	GYF96140	14.0	12	26	83
GYG74160	GYF96160	16.0	16	32	92
GYG74180	GYF96180	18.0	16	32	92
GYG74200	GYF96200	20.0	20	38	104
GYG74220	GYF96220	22.0	20	38	104
GYG74250	GYF96250	25.0	25	45	121

Mill Dia. Tolerance (mm)	Shank Dia. Tolerance
0 ~ - 0.03	h6

◎ : Excellent ○ : Good

ISO Material Description	P										M				K											
	Non-alloy steel					Low alloy steel					High alloyed steel, and tool steel				Stainless steel		Grey cast iron		Nodular cast iron		Malleable cast iron					
VDI 3323	1	2	3	4	5	6	7	8	9	10	11	12	13	14	15	16	17	18	19	20						
HRC	13	25	28	32	10	29	32	38	15	35	15	23	10	10	26	3	25	130	21							
HB	125	190	250	270	300	180	275	300	350	200	325	200	240	180	180	260	160	250	130	230						
Recommend	◎	◎	◎	◎	◎	◎	◎	◎	○	◎	◎	◎	◎	◎	◎	◎	◎	◎	◎	◎						
ISO Material Description	N										S						H									
	Aluminum-wrought alloy		Aluminum-cast, alloyed			Copper and Copper Alloys (Bronze / Brass)			Non Metallic Materials		Heat Resistant Super Alloys						Titanium Alloys		Hardened steel	Chilled Cast Iron	Hardened Cast Iron					
VDI 3323	21	22	23	24	25	26	27	28	29	30	31	32	33	34	35	36	37	38	39	40	41					
HRC	60	100	75	90	130	110	90	100			15	30	25	38	34	200	280	250	350	320	400 Rm	1050 Rm	550	630	400	550
Recommend						○	○	○																		

- CBN END MILLS
- i-Xmill END MILLS
- i-SMART MODULAR END MILLS
- X5070 END MILLS
- 4G MILL END MILLS
- X-POWER PRO END MILLS
- TitaNox-POWER END MILLS
- JET-POWER END MILLS
- V7 PLUS END MILLS
- ALU-POWER HPC END MILLS
- ALU-POWER END MILLS
- D-POWER GRAPHITE END MILLS
- D-POWER CFRP END MILLS
- ROUTERS
- CRX S END MILLS
- K-2 END MILLS
- ONLY ONE COATED PM60 END MILLS
- TANK-POWER END MILLS
- GENERAL HSS END MILLS
- MILLING CUTTERS
- TECHNICAL DATA

PM60, 4 FLUTE MULTIPLE HELIX SHORT LENGTH (Center Cut)

- **PM60, 4 Schneiden, mit ungleichem Drall, kurz, Zentrumschnitt**
- **Revêtue YG-AlCrN - PM60, 4 dents, hélice multiple, série courte (Coupe au centre)**
- **Rivestita PM60, 4 TAGLIENTI elica variabile SERIE CORTA (Tagliante al centro)**

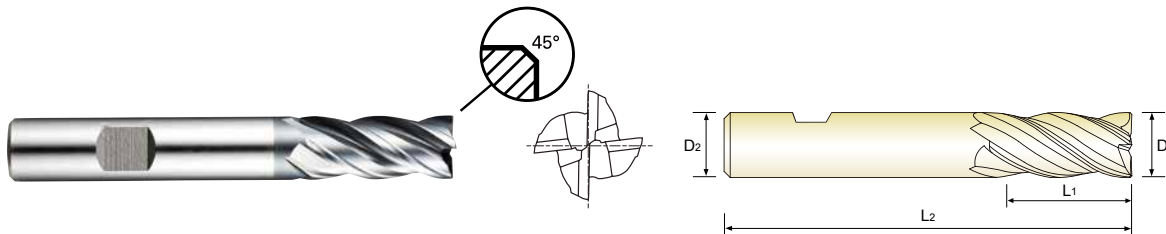

PM 60
4
35°/37°
FLAT
C x 45°
P.633

Unit : mm

EDP No.	Mill Diameter	Shank Diameter	Length of Cut	Overall Length	Chamfer
	D1	D2	L1	L2	
GYG52030	3.0	6	8	52	0.1
GYG52040	4.0	6	11	55	0.1
GYG52050	5.0	6	13	57	0.1
GYG52060	6.0	6	13	57	0.1
GYG52070	7.0	8	16	66	0.1
GYG52080	8.0	8	19	69	0.1
GYG52090	9.0	10	19	69	0.1
GYG52100	10.0	10	22	72	0.1
GYG52120	12.0	12	26	83	0.1
GYG52140	14.0	12	26	83	0.2
GYG52160	16.0	16	32	92	0.2
GYG52180	18.0	16	32	92	0.2
GYG52200	20.0	20	38	104	0.2
GYG52220	22.0	20	38	104	0.2
GYG52250	25.0	25	45	121	0.2

Mill Dia. Tolerance (mm)	Shank Dia. Tolerance
0 ~ -0.03	h6

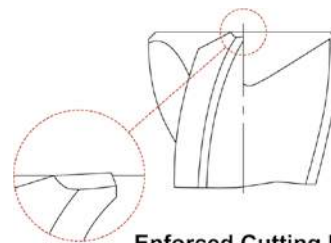

Enforced Cutting Edge

◎ : Excellent ○ : Good

ISO Material Description	P											M				K					
	Non-alloy steel					Low alloy steel				High alloyed steel, and tool steel		Stainless steel		Grey cast iron		Nodular cast iron		Malleable cast iron			
VDI 3323	1	2	3	4	5	6	7	8	9	10	11	12	13	14	15	16	17	18	19	20	
HRc	13	25	28	32	10	29	32	38	15	35	15	23	10	10	26	3	25	42	21		
HB	125	190	250	270	300	180	275	300	350	200	325	200	180	180	260	160	250	130	230		
Recommend	◎	◎	◎	◎	◎	◎	◎	◎	○	◎	○	◎	◎	◎	◎	◎	◎	◎	◎	◎	
ISO Material Description	N										S						H				
	Aluminum-wrought alloy		Aluminum-cast, alloyed			Copper and Copper Alloys (Bronze / Brass)			Non Metallic Materials		Heat Resistant Super Alloys						Titanium Alloys		Hardened steel	Chilled Cast Iron	Hardened Cast Iron
VDI 3323	21	22	23	24	25	26	27	28	29	30	31	32	33	34	35	36	37	38	39	40	41
HRc											15	30	25	38	34			55	60	42	55
HB	60	100	75	90	130	110	90	100			200	280	250	350	320	400 Rm	1050 Rm	550	630	400	550
Recommend						○	○	○												○	○

PM60, 4 FLUTE LONG LENGTH (Center Cut)

- PM60, 4 Schneiden, lang, Zentrumschnitt
- Revêtue YG-AlCrN - PM60, 4 dents, série longue (Coupe au centre)
- Rivestita PM60, 4 TAGLIENTI SERIE LUNGA (Tagliente al centro)

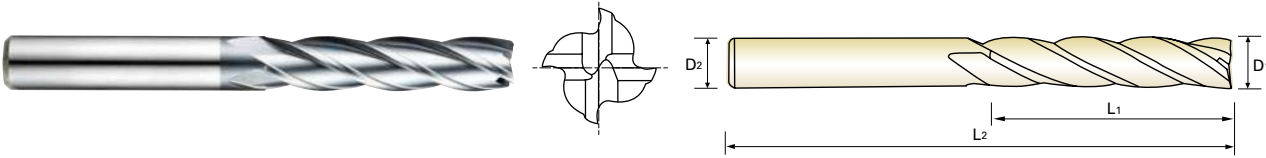

PM 60
4
30°
PLAIN
FLAT
P.632

Unit: mm

EDP No.		Mill Diameter	Shank Diameter	Length of Cut	Overall Length
PLAIN	FLAT	D1	D2	L1	L2
GYG76020	GYG02020	2.0	6	10	54
GYG76030	GYG02030	3.0	6	12	56
GYG76040	GYG02040	4.0	6	19	63
GYG76050	GYG02050	5.0	6	24	68
GYG76060	GYG02060	6.0	6	24	68
GYG76070	GYG02070	7.0	8	30	80
GYG76080	GYG02080	8.0	8	38	88
GYG76090	GYG02090	9.0	10	38	88
GYG76100	GYG02100	10.0	10	45	95
GYG76120	GYG02120	12.0	12	53	110
GYG76140	GYG02140	14.0	12	53	110
GYG76160	GYG02160	16.0	16	63	123
GYG76180	GYG02180	18.0	16	63	123
GYG76200	GYG02200	20.0	20	75	141
GYG76220	GYG02220	22.0	20	75	141
GYG76250	GYG02250	25.0	25	90	166

Mill Dia. Tolerance (mm)	Shank Dia. Tolerance
0 ~ - 0.03	h6

◎ : Excellent ○ : Good

ISO Material Description	P										M				K						
	Non-alloy steel					Low alloy steel					High alloyed steel, and tool steel				Stainless steel		Grey cast iron		Nodular cast iron		Malleable cast iron
VDI 3323	1	2	3	4	5	6	7	8	9	10	11	12	13	14	15	16	17	18	19	20	
HRC		13	25	28	32	10	29	32	38	15	35	15	23	10	10	26	3	25	3	21	
HB	125	190	250	270	300	180	275	300	350	200	325	200	240	180	180	260	160	250	130	230	
Recommend	◎	◎	◎	◎	◎	◎	◎	◎	○	◎	◎	◎	◎	◎	◎	◎	◎	◎	◎	◎	

ISO Material Description	N					S										H					
	Aluminum-wrought alloy		Aluminum-cast, alloyed			Copper and Copper Alloys (Bronze / Brass)			Non Metallic Materials		Heat Resistant Super Alloys					Titanium Alloys		Hardened steel	Chilled Cast Iron	Hardened Cast Iron	
VDI 3323	21	22	23	24	25	26	27	28	29	30	31	32	33	34	35	36	37	38	39	40	41
HRC											15	30	25	38	34	55	60	55	60	42	55
HB	60	100	75	90	130	110	90	100			200	280	250	350	320	400 Rm	1050 Rm	550	630	400	550
Recommend						○	○	○												○	

- CBN END MILLS
- i-Xmill END MILLS
- i-SMART MODULAR END MILLS
- X5070 END MILLS
- 4G MILL END MILLS
- X-POWER PRO END MILLS
- TitaNox-POWER END MILLS
- JET-POWER END MILLS
- V7 PLUS END MILLS
- ALU-POWER HPC END MILLS
- ALU-POWER END MILLS
- D-POWER GRAPHITE END MILLS
- D-POWER CFRP END MILLS
- ROUTERS
- CRX S END MILLS
- K-2 END MILLS
- ONLY ONE COATED PM60 END MILLS
- TANK-POWER END MILLS
- GENERAL HSS END MILLS
- MILLING CUTTERS
- TECHNICAL DATA

PM60, MULTI FLUTE MULTIPLE HELIX SHORT LENGTH CORNER RADIUS ROUGHING - FINE (Center Cut)

● **PM60, Mehrschneiden, mit ungleichem Drall, kurz, Eckenradius, Feinkordel-Schruppfräser, Zentrumschnitt**
● **Revêtue YG-AlCrN - PM60, multi-dents, hélice multiple, série courte, rayonnée, ravageuse, pas fins (Coupe au centre)**
● **Rivestita PM60, MULTI TAGLIENTE ELICA VARIABILE SERIE CORTA TORICA PER SGROSSATURA - BOMBATO FINE (Tagliante al centro)**

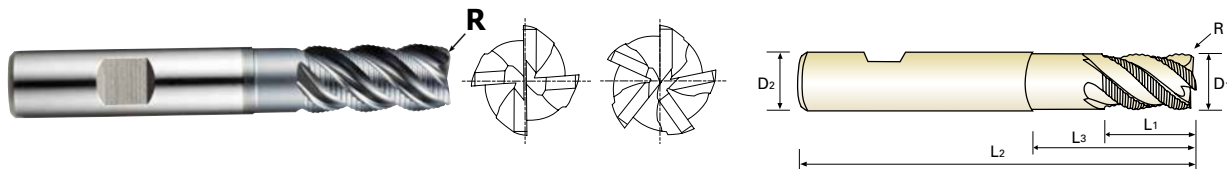

PM 60
4-5
44°/44.5° /45°
HR
FLAT
P.634

Unit : mm

EDP No.	Corner Radius	Mill Diameter	Shank diameter	Length of Cut	Length Below Shank	Overall length	No. of Flute
	R	D1(js12)	D2(h6)	L1	L3	L2	
GYF95060	R0.5	6.0	6	13	-	57	4
GYF95070	R0.5	7.0	10	16	-	66	4
GYF95080	R0.5	8.0	10	19	-	69	4
GYF95090	R0.5	9.0	10	19	-	69	4
GYF95100	R0.5	10.0	10	22	31	72	4
GYF95120	R0.5	12.0	12	26	37	83	4
GYF95140	R1.0	14.0	12	26	-	83	5
GYF95160	R1.0	16.0	16	32	44	92	5
GYF95180	R1.0	18.0	16	32	-	92	5
GYF95200	R1.0	20.0	20	38	54	104	5
GYF95250	R1.0	25.0	25	45	63	121	5

Tolerances according to DIN 7160 & 7161

Tolerance range in μm			
Nominal-Diameter in mm			
	over 6 to 10	over 10 to 18	over 18 to 30
js12	± 75	± 90	± 105
h6	0 - 9	0 - 11	0 - 13

◎ : Excellent ○ : Good

ISO Material Description	P											M				K					
	Non-alloy steel					Low alloy steel				High alloyed steel, and tool steel		Stainless steel		Grey cast iron		Nodular cast iron		Malleable cast iron			
VDI 3323	1	2	3	4	5	6	7	8	9	10	11	12	13	14	15	16	17	18	19	20	
HRc	13	25	28	32	10	29	32	38	15	35	15	23	10	10	26	3	25		21		
HB	125	190	250	270	300	180	275	300	350	200	325	200	240	180	180	260	160	250	130	230	
Recommend	◎	◎	◎	◎	◎	◎	◎	◎	○	◎	○	◎	◎	◎	◎	◎	◎	◎	◎	◎	
ISO Material Description	N										S					H					
	Aluminum-wrought alloy		Aluminum-cast, alloyed			Copper and Copper Alloys (Bronze / Brass)			Non Metallic Materials		Heat Resistant Super Alloys					Titanium Alloys		Hardened steel	Chilled Cast Iron	Hardened Cast Iron	
VDI 3323	21	22	23	24	25	26	27	28	29	30	31	32	33	34	35	36	37	38	39	40	41
HRc											15	30	25	38	34			55	60	42	55
HB	60	100	75	90	130	110	90	100			200	280	250	350	320	400 Rm	1050 Rm	550	630	400	550
Recommend						○	○	○												○	○

PM60, MULTI FLUTE SHORT LENGTH ROUGHING - FINE (Center Cut)

- PM60, Mehrschneiden, kurz, Feinkordel-Schuppfräser, Zentrumschnitt
- Revêtue YG-AiCrN - PM60, multi-dents, série courte, ravageuse, pas fins (Coupe au centre)
- Rivestita PM60, MULTI TAGLIENTE SERIE CORTA PER SGROSSATURA - BOMBATO FINE (Tagliante al centro)

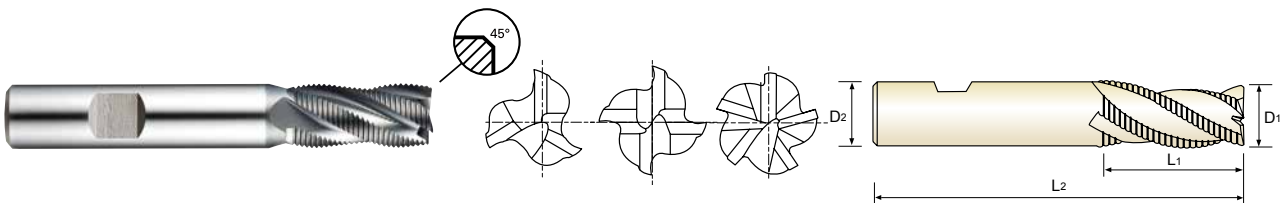

PM 60
3-5
30°
HR
FLAT
C x 45°
P.635

Unit : mm

EDP No.	Mill Diameter	Shank Diameter	Length of Cut	Overall Length	No. of Flute	Chamfer
	D1(js12)	D2(h6)	L1	L2		
GYF94060	6.0	6	13	57	3	0.18
GYF94070	7.0	10	16	66	3	0.18
GYF94080	8.0	10	19	69	3	0.18
GYF94090	9.0	10	19	69	3	0.18
GYF94100	10.0	10	22	72	4	0.18
GYF94120	12.0	12	26	83	4	0.18
GYF94140	14.0	12	26	83	4	0.25
GYF94160	16.0	16	32	92	4	0.25
GYF94180	18.0	16	32	92	4	0.25
GYF94200	20.0	20	38	104	4	0.25
GYF94250	25.0	25	45	121	5	0.36

Tolerances according to DIN 7160 & 7161

Tolerance range in μm			
Nominal-Diameter in mm			
	over 6 to 10	over 10 to 18	over 18 to 30
js12	± 75	± 90	± 105
h6	0 - 9	0 - 11	0 - 13

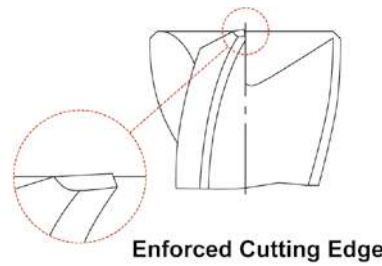

Enforced Cutting Edge

◎ : Excellent ○ : Good

ISO Material Description	P										M				K						
	Non-alloy steel					Low alloy steel					High alloyed steel, and tool steel				Stainless steel		Grey cast iron		Nodular cast iron		Malleable cast iron
	1	2	3	4	5	6	7	8	9	10	11	12	13	14	15	16	17	18	19	20	
VDI 3323	1	2	3	4	5	6	7	8	9	10	11	12	13	14	15	16	17	18	19	20	
HRc	13	25	28	32	30	29	32	38	35	20	35	15	23	10	10	26	3	25	42	21	
HB	125	190	250	270	300	180	275	300	350	200	325	200	240	180	180	260	160	250	130	230	
Recommend	◎	◎	◎	◎	◎	◎	◎	◎	◎	◎	◎	◎	◎	◎	◎	◎	◎	◎	◎	◎	
ISO Material Description	N										S						H				
	Aluminum-wrought alloy		Aluminum-cast, alloyed			Copper and Copper Alloys (Bronze / Brass)			Non Metallic Materials		Heat Resistant Super Alloys						Titanium Alloys		Hardened steel	Chilled Cast Iron	Hardened Cast Iron
	21	22	23	24	25	26	27	28	29	30	31	32	33	34	35	36	37	38	39	40	41
VDI 3323	21	22	23	24	25	26	27	28	29	30	31	32	33	34	35	36	37	38	39	40	41
HRc	60	100	75	90	130	110	90	100			15	30	25	38	34	55	60	55	60	42	55
HB	60	100	75	90	130	110	90	100			200	280	250	350	320	400 Rm	1050 Rm	550	630	400	550
Recommend						○	○	○												○	

PM60, MULTI FLUTE LONG LENGTH ROUGHING - FINE (Center Cut)

- **PM60, Mehrschneiden, lang, Feinkordel-Schruppfräser, Zentrumschnitt**
- **Revêtue YG-AlCrN - PM60, multi-dents, série longue, ravageuse, pas fins (Coupe au centre)**
- **Rivestita PM60, MULTI TAGLIENTE SERIE LUNGA PER SGROSSATURA - BOMBATO FINE (Tagliante al centro)**

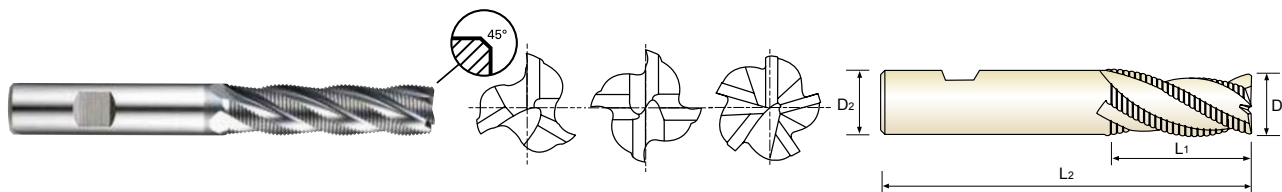

PM 60
3-5
30°
HR
FLAT
C x 45°
P.635

Unit : mm

EDP No.	Mill Diameter	Shank Diameter	Length of Cut	Overall Length	No. of Flute	Chamfer
	D1(js12)	D2(h6)	L1	L2		
GYF98060	6.0	6	24	68	3	0.18
GYF98070	7.0	10	30	80	3	0.18
GYF98080	8.0	10	38	88	3	0.18
GYF98090	9.0	10	38	88	3	0.18
GYF98100	10.0	10	45	95	4	0.18
GYF98120	12.0	12	53	110	4	0.18
GYF98140	14.0	12	53	110	4	0.25
GYF98160	16.0	16	63	123	4	0.25
GYF98180	18.0	16	63	123	4	0.25
GYF98200	20.0	20	75	141	4	0.25
GYF98250	25.0	25	90	166	5	0.36

Tolerances according to DIN 7160 & 7161

Tolerance range in μm			
Nominal-Diameter in mm			
	over 6 to 10	over 10 to 18	over 18 to 30
js12	± 75	± 90	± 105
h6	0 - 9	0 - 11	0 - 13

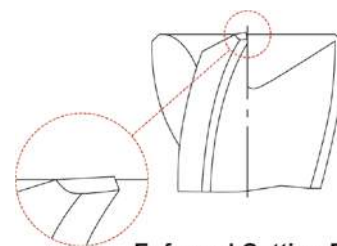

Enforced Cutting Edge

◎ : Excellent ○ : Good

ISO Material Description	P											M				K								
	Non-alloy steel					Low alloy steel						High alloyed steel, and tool steel				Stainless steel				Grey cast iron		Nodular cast iron		Malleable cast iron
VDI 3323	1	2	3	4	5	6	7	8	9	10	11	12	13	14	15	16	17	18	19	20				
HRc	13	25	28	32	10	29	32	38	15	35	15	23	10	10	26	3	25							
HB	125	190	250	270	300	180	275	300	350	200	325	200	240	180	180	260	160	250	130	230				
Recommend	◎	◎	◎	◎	◎	◎	◎	◎	○	◎	○	◎	◎	◎	◎	◎	◎	◎	◎	◎				
ISO Material Description	N										S							H						
	Aluminum-wrought alloy		Aluminum-cast, alloyed			Copper and Copper Alloys (Bronze / Brass)			Non Metallic Materials		Heat Resistant Super Alloys							Titanium Alloys		Hardened steel	Chilled Cast Iron	Hardened Cast Iron		
VDI 3323	21	22	23	24	25	26	27	28	29	30	31	32	33	34	35	36	37	38	39	40	41			
HRc											15	30	25	38	34			55	60	42	55			
HB	60	100	75	90	130	110	90	100			200	280	250	350	320	400 Rm	1050 Rm	550	630	400	550			
Recommend						○	○	○													○			

PM60, MULTI FLUTE SHORT LENGTH ROUGHING - COARSE(Center Cut)

- **PM60, Mehrschneiden, kurz, Schruppfräser, Zentrumschnitt**
- **Revêtue YG-AlCrN - PM60, multi-dents, série courte, ravageuse, pas grossiers (Coupe au centre)**
- **Rivestita PM60, MULTI TAGLIENTE SERIE CORTA PER SGROSSATURA - BOMBATO GROSSO (Tagliante al centro)**

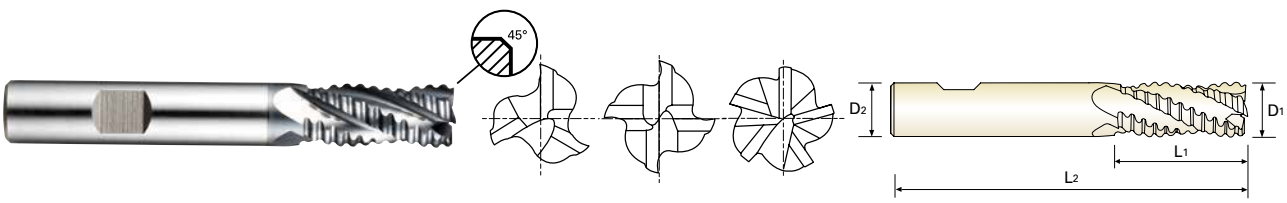

PM 60

3-5

30°

NR

FLAT

C x 45°

P.635

Unit : mm

EDP No.	Mill Diameter	Shank Diameter	Length of Cut	Overall Length	No. of Flute	Chamfer
	D1(js12)	D2(h6)	L1	L2		
GYG03060	6.0	6	13	57	3	0.25
GYG03070	7.0	10	16	66	3	0.25
GYG03080	8.0	10	19	69	3	0.25
GYG03090	9.0	10	19	69	3	0.36
GYG03100	10.0	10	22	72	4	0.36
GYG03120	12.0	12	26	83	4	0.56
GYG03140	14.0	12	26	83	4	0.6
GYG03160	16.0	16	32	92	4	0.6
GYG03180	18.0	16	32	92	4	0.6
GYG03200	20.0	20	38	104	4	0.6
GYG03250	25.0	25	45	121	5	0.6

Tolerances according to DIN 7160 & 7161

Tolerance range in μm			
Nominal-Diameter in mm			
	over 6 to 10	over 10 to 18	over 18 to 30
js12	± 75	± 90	± 105
h6	0 - 9	0 - 11	0 - 13

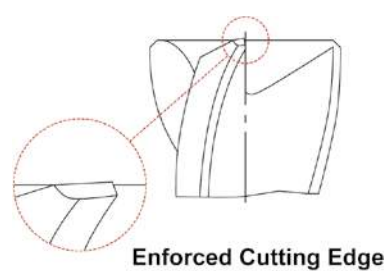

ISO	P										M				K						
	Non-alloy steel					Low alloy steel					High alloyed steel, and tool steel				Stainless steel		Grey cast iron		Nodular cast iron		Malleable cast iron
Material Description	1	2	3	4	5	6	7	8	9	10	11	12	13	14	15	16	17	18	19	20	
VDI 3323	1	2	3	4	5	6	7	8	9	10	11	12	13	14	15	16	17	18	19	20	
HRC	13	25	28	32	30	29	32	38	35	35	35	15	23	10	10	26	3	25	42	21	
HB	125	190	250	270	300	180	275	300	350	200	325	200	240	180	180	260	160	250	130	230	
Recommend	⊙	⊙	⊙	⊙	⊙	⊙	⊙	⊙	○	⊙	⊙	⊙	⊙	⊙	⊙	⊙	⊙	⊙	⊙	⊙	
ISO	N										S						H				
	Aluminum-wrought alloy		Aluminum-cast, alloyed			Copper and Copper Alloys (Bronze / Brass)			Non Metallic Materials		Heat Resistant Super Alloys						Titanium Alloys		Hardened steel	Chilled Cast Iron	Hardened Cast Iron
Material Description	21	22	23	24	25	26	27	28	29	30	31	32	33	34	35	36	37	38	39	40	41
VDI 3323	21	22	23	24	25	26	27	28	29	30	31	32	33	34	35	36	37	38	39	40	41
HRC	60	100	75	90	130	110	90	100			15	30	25	38	34	55	60	55	60	42	55
HB	60	100	75	90	130	110	90	100			200	280	250	350	320	400 Rm	1050 Rm	550	630	400	550
Recommend						○	○	○												○	

⊙ : Excellent ○ : Good

- CBN END MILLS
- i-Xmill END MILLS
- i-SMART MODULAR END MILLS
- X5070 END MILLS
- 4G MILL END MILLS
- X-POWER PRO END MILLS
- TitaNox-POWER END MILLS
- JET-POWER END MILLS
- V7 PLUS END MILLS
- ALU-POWER HPC END MILLS
- ALU-POWER END MILLS
- D-POWER GRAPHITE END MILLS
- D-POWER CFRP END MILLS
- ROUTERS
- CRX S END MILLS
- K-2 END MILLS
- ONLY ONE COATED PM60 END MILLS
- TANK-POWER END MILLS
- GENERAL HSS END MILLS
- MILLING CUTTERS
- TECHNICAL DATA



ONLY ONE
COATED PM60 END MILLS

RECOMMENDED CUTTING CONDITIONS
EMPFOHLENE SCHNEIDPARAMETER

GYG77 , GYF97 SERIES

2 FLUTE BALL NOSE

Vc = m/min.
fz = mm/tooth
RPM = rev./min.
FEED = mm/min.

ISO	VDI 3323	Material Description	Ae	Ap	Parameter	Diameter (Ø)									
						3.0	4.0	6.0	8.0	10.0	12.0	16.0	20.0	25.0	
P	1	Non-alloy steel	0.5D	0.2D	Vc	83	90	100	101	104	104	103	102	90	
					fz	0.023	0.036	0.054	0.079	0.109	0.115	0.141	0.156	0.162	
					RPM	8807	7162	5305	4019	3310	2759	2049	1623	1146	
					FEED	405	516	573	635	722	634	578	506	371	
	2		0.5D	0.2D	Vc	66	70	79	78	79	81	78	75	70	
					fz	0.020	0.032	0.046	0.067	0.095	0.097	0.123	0.140	0.140	
					RPM	7003	5570	4191	3104	2515	2149	1552	1194	891	
					FEED	280	357	386	416	478	417	382	334	250	
	3-4		0.5D	0.2D	Vc	44	45	52	54	53	54	54	52	44	
					fz	0.016	0.026	0.039	0.056	0.082	0.083	0.1	0.11	0.125	
					RPM	4669	3581	2759	2149	1687	1432	1074	828	560	
					FEED	149	186	215	241	277	238	215	182	140	
5	0.5D	0.2D	Vc	23	24	27	27	26	26	27	27	24			
			fz	0.014	0.023	0.035	0.047	0.073	0.071	0.090	0.099	0.100			
			RPM	2440	1910	1432	1074	828	690	537	430	306			
			FEED	68	88	100	101	121	98	97	85	61			
6	0.5D	0.2D	Vc	66	70	79	78	79	81	78	75	70			
			fz	0.020	0.032	0.046	0.067	0.095	0.097	0.123	0.140	0.140			
			RPM	7003	5570	4191	3104	2515	2149	1552	1194	891			
			FEED	280	357	386	416	478	417	382	334	250			
7	0.5D	0.2D	Vc	44	45	52	54	53	54	54	52	44			
			fz	0.016	0.026	0.039	0.056	0.082	0.083	0.1	0.11	0.125			
			RPM	4669	3581	2759	2149	1687	1432	1074	828	560			
			FEED	149	186	215	241	277	238	215	182	140			
8-9	0.5D	0.2D	Vc	23	24	27	27	26	26	27	27	24			
			fz	0.014	0.023	0.035	0.047	0.073	0.071	0.090	0.099	0.100			
			RPM	2440	1910	1432	1074	828	690	537	430	306			
			FEED	68	88	100	101	121	98	97	85	61			
10	0.5D	0.2D	Vc	66	70	79	78	79	81	78	75	70			
			fz	0.020	0.032	0.046	0.067	0.095	0.097	0.123	0.140	0.140			
			RPM	7003	5570	4191	3104	2515	2149	1552	1194	891			
			FEED	280	357	386	416	478	417	382	334	250			
11.1	0.5D	0.2D	Vc	23	24	27	27	26	26	27	27	24			
			fz	0.014	0.023	0.035	0.047	0.073	0.071	0.090	0.099	0.100			
			RPM	2440	1910	1432	1074	828	690	537	430	306			
			FEED	68	88	100	101	121	98	97	85	61			
11.2	0.3D	0.2D	Vc	16	17	19	19	18	18	19	19	16			
			fz	0.013	0.024	0.035	0.047	0.075	0.071	0.088	0.1	0.095			
			RPM	1698	1353	1008	756	573	477	378	302	204			
			FEED	44	65	71	71	86	67	67	60	39			
M	14.1	Stainless steel	0.5D	0.2D	Vc	25	27	30	30	28	29	30	30	26	
					fz	0.013	0.023	0.036	0.049	0.072	0.075	0.093	0.099	0.098	
					RPM	2653	2149	1592	1194	891	769	597	477	331	
					FEED	69	99	115	117	128	115	111	95	65	
K	15-20	Grey cast iron Nodular cast iron Malleable cast iron	0.5D	0.2D	Vc	66	70	79	78	79	81	78	75	70	
					fz	0.02	0.032	0.046	0.067	0.095	0.097	0.123	0.14	0.14	
					RPM	7003	5570	4191	3104	2515	2149	1552	1194	891	
					FEED	280	357	386	416	478	417	382	334	250	
H	40	Chilled Cast Iron	0.3D	0.2D	Vc	16	17	19	19	18	18	19	19	16	
					fz	0.013	0.024	0.035	0.047	0.075	0.071	0.088	0.1	0.095	
					RPM	1698	1353	1008	756	573	477	378	302	204	
					FEED	44	65	71	71	86	68	67	60	39	

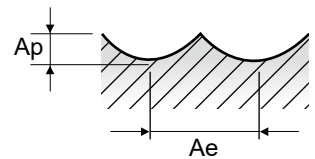

Vc = m/min.
fz = mm/tooth
RPM = rev./min.
FEED = mm/min.

GYG72 , GYF99 SERIES 2 FLUTE - SLOTTING

ISO	VDI 3323	Material Description	Ae	Ap	Parameter	Diameter (Ø)															
						2.0	3.0	4.0	5.0	6.0	8.0	10.0	12.0	14.0	16.0	18.0	20.0	22.0	25.0		
P	1	Non-alloy steel	1.0D	0.5D	Vc	53	57	65	74	79	78	79	81	84	81	78	72	70	71		
					fz	0.008	0.016	0.027	0.033	0.038	0.053	0.071	0.076	0.083	0.099	0.105	0.116	0.109	0.103		
					RPM	8435	6048	5173	4711	4191	3104	2515	2149	1910	1611	1379	1146	1013	904		
	2		1.0D	0.5D	Vc	44	46	54	61	66	66	68	66	66	69	64	59	59	60		
					fz	0.008	0.016	0.024	0.031	0.036	0.055	0.074	0.083	0.083	0.085	0.103	0.106	0.106	0.112		
					RPM	7003	4881	4297	3883	3501	2626	2165	1751	1501	1373	1132	939	854	764		
	3-4		1.0D	0.5D	Vc	37	38	48	49	52	54	55	52	53	54	54	53	50	46		
					fz	0.008	0.017	0.025	0.035	0.042	0.056	0.079	0.091	0.098	0.1	0.1	0.107	0.104	0.119		
					RPM	5889	4032	3820	3119	2759	2149	1751	1379	1205	1074	955	844	723	586		
	5		1.0D	0.5D	Vc	94	137	191	218	232	241	277	251	236	215	191	181	150	139		
					fz	0.011	0.017	0.023	0.029	0.037	0.051	0.069	0.079	0.086	0.09	0.1	0.104	0.099	0.105		
					RPM	3820	2759	2387	2037	1751	1393	1082	902	750	676	601	525	477	433		
6	1.0D	0.5D	Vc	24	26	30	32	33	35	34	34	33	34	34	33	33	34				
			fz	0.011	0.017	0.023	0.029	0.037	0.051	0.069	0.079	0.086	0.09	0.1	0.104	0.099	0.105				
			RPM	3820	2759	2387	2037	1751	1393	1082	902	750	676	601	525	477	433				
7	1.0D	0.5D	Vc	84	94	110	118	130	142	149	142	129	122	120	109	95	91				
			fz	0.008	0.016	0.024	0.031	0.036	0.055	0.074	0.083	0.083	0.085	0.103	0.106	0.106	0.112				
			RPM	7003	4881	4297	3883	3501	2626	2165	1751	1501	1373	1132	939	854	764				
8	1.0D	0.5D	Vc	112	156	206	241	252	289	320	291	249	233	233	199	181	171				
			fz	0.008	0.016	0.024	0.031	0.036	0.055	0.074	0.083	0.083	0.085	0.103	0.106	0.106	0.112				
			RPM	7003	4881	4297	3883	3501	2626	2165	1751	1501	1373	1132	939	854	764				
9	1.0D	0.3D	Vc	37	38	48	49	52	54	55	52	53	54	54	53	50	46				
			fz	0.008	0.017	0.025	0.035	0.042	0.056	0.079	0.091	0.098	0.1	0.1	0.107	0.104	0.119				
			RPM	5889	4032	3820	3119	2759	2149	1751	1379	1205	1074	955	844	723	586				
10	1.0D	0.5D	Vc	24	26	30	32	33	35	34	34	33	34	34	33	33	34				
			fz	0.011	0.017	0.023	0.029	0.037	0.051	0.069	0.079	0.086	0.09	0.1	0.104	0.099	0.105				
			RPM	3820	2759	2387	2037	1751	1393	1082	902	750	676	601	525	477	433				
11.1	1.0D	0.5D	Vc	84	94	110	118	130	142	149	142	129	122	120	109	95	91				
			fz	0.011	0.017	0.023	0.029	0.037	0.051	0.069	0.079	0.086	0.09	0.1	0.104	0.099	0.105				
			RPM	3820	2759	2387	2037	1751	1393	1082	902	750	676	601	525	477	433				
11.2	1.0D	0.3D	Vc	15	20	24	25	26	27	26	26	26	27	27	27	26	24				
			fz	0.01	0.017	0.023	0.028	0.036	0.047	0.071	0.071	0.079	0.09	0.094	0.099	0.086	0.1				
			RPM	2387	2122	1910	1592	1379	1074	828	690	591	537	477	430	376	306				
M	14.1	Stainless steel	1.0D	0.5D	Vc	48	72	88	89	99	107	118	98	93	97	90	85	65	61		
					fz	0.01	0.017	0.023	0.028	0.036	0.047	0.071	0.071	0.079	0.09	0.094	0.099	0.086	0.1		
					RPM	2387	2122	1910	1592	1379	1074	828	690	591	537	477	430	376	306		
K	15-20	Grey cast iron Nodular cast iron Malleable cast iron	1.0D	0.5D	Vc	17	22	27	28	29	30	29	29	29	29	30	30	29	26		
					fz	0.01	0.018	0.024	0.028	0.036	0.047	0.071	0.071	0.08	0.091	0.094	0.101	0.083	0.098		
					RPM	2706	2334	2149	1783	1538	1194	923	769	659	577	531	477	420	331		
H	40	Chilled Cast Iron	1.0D	0.3D	Vc	54	84	103	100	111	112	131	109	105	107	100	96	70	65		
					fz	0.011	0.017	0.023	0.029	0.037	0.051	0.069	0.079	0.086	0.09	0.1	0.104	0.099	0.105		
					RPM	3820	2759	2387	2037	1751	1393	1082	902	750	676	601	525	477	433		

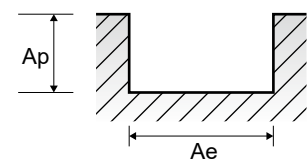

YG ONLY ONE
COATED PM60 END MILLS

RECOMMENDED CUTTING CONDITIONS
EMPFOHLENE SCHNEIDPARAMETER

GYG01 SERIES **3 FLUTE - SLOTTING**

Vc = m/min.
fz = mm/tooth
RPM = rev./min.
FEED = mm/min.

ISO	VDI 3323	Material Description	Ae	Ap	Parameter	Diameter (Ø)													
						2.0	3.0	4.0	5.0	6.0	8.0	10.0	12.0	14.0	16.0	18.0	20.0	22.0	25.0
P	1	Non-alloy steel	1.0D	0.5D	Vc	49	52	65	72	76	78	79	81	84	81	78	72	70	71
					fz	0.004	0.007	0.011	0.014	0.023	0.031	0.04	0.051	0.052	0.06	0.07	0.08	0.091	0.107
					RPM	7799	5517	5173	4584	4032	3104	2515	2149	1910	1611	1379	1146	1013	904
	2		1.0D	0.5D	Vc	41	44	54	60	63	66	68	66	71	69	61	60	61	60
					fz	0.003	0.007	0.011	0.013	0.023	0.032	0.039	0.053	0.055	0.06	0.072	0.081	0.089	0.11
					RPM	6525	4669	4297	3820	3342	2626	2165	1751	1614	1373	1079	955	883	764
	3-4		1.0D	0.5D	Vc	36	38	45	49	52	54	53	54	53	54	54	53	50	46
					fz	0.003	0.005	0.009	0.012	0.021	0.028	0.038	0.047	0.053	0.056	0.063	0.067	0.083	0.107
					RPM	5730	4032	3581	3119	2759	2149	1687	1432	1205	1074	955	844	723	586
	5		1.0D	0.5D	Vc	23	25	29	32	33	35	34	34	35	34	34	33	33	34
					fz	0.004	0.007	0.009	0.012	0.021	0.029	0.044	0.052	0.055	0.06	0.064	0.069	0.08	0.093
					RPM	3661	2653	2308	2037	1751	1393	1082	902	796	676	601	525	477	433
6	1.0D	0.5D	Vc	41	44	54	60	63	66	68	66	71	69	61	60	61	60		
			fz	0.003	0.007	0.011	0.013	0.023	0.032	0.039	0.053	0.055	0.06	0.072	0.081	0.089	0.11		
			RPM	6525	4669	4297	3820	3342	2626	2165	1751	1614	1373	1079	955	883	764		
7	1.0D	0.5D	Vc	36	38	45	49	52	54	53	54	53	54	54	53	50	46		
			fz	0.003	0.005	0.009	0.012	0.021	0.028	0.038	0.047	0.053	0.056	0.063	0.067	0.083	0.107		
			RPM	5730	4032	3581	3119	2759	2149	1687	1432	1205	1074	955	844	723	586		
8	1.0D	0.5D	Vc	23	25	29	32	33	35	34	34	35	34	34	33	33	34		
			fz	0.004	0.007	0.009	0.012	0.021	0.029	0.044	0.052	0.055	0.06	0.064	0.069	0.08	0.093		
			RPM	3661	2653	2308	2037	1751	1393	1082	902	796	676	601	525	477	433		
9	1.0D	0.3D	Vc	14	20	23	25	25	27	26	26	26	27	27	27	26	24		
			fz	0.005	0.008	0.012	0.014	0.023	0.031	0.045	0.052	0.056	0.063	0.066	0.074	0.088	0.111		
			RPM	2228	2122	1830	1592	1326	1074	828	690	591	537	477	430	376	306		
10	1.0D	0.5D	Vc	41	44	54	60	63	66	68	66	71	69	61	60	61	60		
			fz	0.003	0.007	0.011	0.013	0.023	0.032	0.039	0.053	0.055	0.06	0.072	0.081	0.089	0.11		
			RPM	6525	4669	4297	3820	3342	2626	2165	1751	1614	1373	1079	955	883	764		
11.1	1.0D	0.5D	Vc	23	25	29	32	33	35	34	34	35	34	34	33	33	34		
			fz	0.004	0.007	0.009	0.012	0.021	0.029	0.044	0.052	0.055	0.06	0.064	0.069	0.08	0.093		
			RPM	3661	2653	2308	2037	1751	1393	1082	902	796	676	601	525	477	433		
11.2	1.0D	0.3D	Vc	10	14	16	17	17	19	18	18	18	19	19	19	19	16		
			fz	0.005	0.009	0.012	0.014	0.024	0.031	0.044	0.051	0.056	0.063	0.064	0.072	0.086	0.111		
			RPM	1592	1485	1273	1082	902	756	573	477	409	378	336	302	275	204		
M	14.1	Stainless steel	1.0D	0.5D	Vc	41	44	54	60	63	66	68	66	71	69	61	60	61	60
					fz	0.003	0.007	0.011	0.013	0.023	0.032	0.039	0.053	0.055	0.06	0.072	0.081	0.089	0.11
					RPM	6525	4669	4297	3820	3342	2626	2165	1751	1614	1373	1079	955	883	764
K	15-20	Grey cast iron Nodular cast iron Malleable cast iron	1.0D	0.5D	Vc	41	44	54	60	63	66	68	66	71	69	61	60	61	60
					fz	0.003	0.007	0.011	0.013	0.023	0.032	0.039	0.053	0.055	0.06	0.072	0.081	0.089	0.11
					RPM	6525	4669	4297	3820	3342	2626	2165	1751	1614	1373	1079	955	883	764
H	40	Chilled Cast Iron	1.0D	0.3D	Vc	10	14	16	17	17	19	18	18	18	19	19	19	16	
					fz	0.005	0.009	0.012	0.014	0.024	0.031	0.044	0.051	0.056	0.063	0.064	0.072	0.086	0.111
					RPM	1592	1485	1273	1082	902	756	573	477	409	378	336	302	275	204

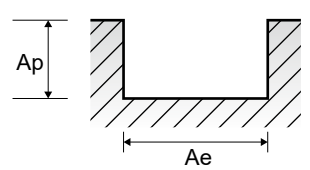

GYG01 SERIES

3 FLUTE - SIDE CUTTING

Vc = m/min.
fz = mm/tooth
RPM = rev./min.
FEED = mm/min.

ISO	VDI 3323	Material Description	Ae	Ap	Parameter	Diameter (Ø)															
						2.0	3.0	4.0	5.0	6.0	8.0	10.0	12.0	14.0	16.0	18.0	20.0	22.0	25.0		
P	1	Non-alloy steel	0.1D	1.5D	Vc	62	66	78	89	95	97	94	95	95	97	92	94	95	94		
					fz	0.004	0.008	0.012	0.015	0.024	0.034	0.047	0.056	0.065	0.069	0.076	0.08	0.089	0.11		
					RPM	9868	7003	6207	5666	5040	3860	2992	2520	2160	1930	1627	1496	1375	1197		
	2		0.1D	1.5D	Vc	51	54	66	75	81	78	79	81	79	78	78	79	79	79		
					fz	0.004	0.008	0.012	0.015	0.023	0.035	0.046	0.056	0.063	0.071	0.077	0.081	0.094	0.109		
					RPM	8117	5730	5252	4775	4297	3104	2515	2149	1796	1552	1379	1257	1143	1006		
	3-4		0.1D	1.5D	Vc	41	43	53	55	59	60	60	63	61	60	61	59	62	60		
					fz	0.004	0.007	0.01	0.014	0.025	0.033	0.043	0.055	0.06	0.067	0.073	0.082	0.088	0.11		
					RPM	6525	4562	4218	3501	3130	2387	1910	1671	1387	1194	1079	939	897	764		
	5		0.1D	1.5D	Vc	29	31	35	38	41	39	38	41	41	40	40	39	39	39		
fz		0.004			0.008	0.011	0.014	0.023	0.036	0.05	0.056	0.06	0.072	0.074	0.081	0.092	0.107				
RPM		4615			3289	2785	2419	2175	1552	1210	1088	932	796	707	621	564	497				
6	0.1D	1.5D	Vc	51	54	66	75	81	78	79	81	79	78	78	79	79	79				
			fz	0.004	0.008	0.012	0.015	0.023	0.035	0.046	0.056	0.063	0.071	0.077	0.081	0.094	0.109				
			RPM	8117	5730	5252	4775	4297	3104	2515	2149	1796	1552	1379	1257	1143	1006				
7	0.1D	1.5D	Vc	41	43	53	55	59	60	60	63	61	60	61	59	62	60				
			fz	0.004	0.007	0.01	0.014	0.025	0.033	0.043	0.055	0.06	0.067	0.073	0.082	0.088	0.11				
			RPM	6525	4562	4218	3501	3130	2387	1910	1671	1387	1194	1079	939	897	764				
8	0.1D	1.5D	Vc	29	31	35	38	41	39	38	41	41	40	40	39	39	39				
			fz	0.004	0.008	0.011	0.014	0.023	0.036	0.05	0.056	0.06	0.072	0.074	0.081	0.092	0.107				
			RPM	4615	3289	2785	2419	2175	1552	1210	1088	932	796	707	621	564	497				
9	0.05D	1.5D	Vc	18	25	29	32	34	33	34	34	33	33	34	33	33	34				
			fz	0.006	0.01	0.013	0.015	0.022	0.035	0.047	0.056	0.064	0.071	0.072	0.082	0.09	0.112				
			RPM	2865	2653	2308	2037	1804	1313	1082	902	750	657	601	525	477	433				
10	0.1D	1.5D	Vc	51	54	66	75	81	78	79	81	79	78	78	79	79	79				
			fz	0.004	0.008	0.012	0.015	0.023	0.035	0.046	0.056	0.063	0.071	0.077	0.081	0.094	0.109				
			RPM	8117	5730	5252	4775	4297	3104	2515	2149	1796	1552	1379	1257	1143	1006				
11.1	0.1D	1.5D	Vc	29	31	35	38	41	39	38	41	41	40	40	39	39	39				
			fz	0.004	0.008	0.011	0.014	0.023	0.036	0.05	0.056	0.06	0.072	0.074	0.081	0.092	0.107				
			RPM	4615	3289	2785	2419	2175	1552	1210	1088	932	796	707	621	564	497				
11.2	0.05D	1.5D	Vc	13	17	20	22	24	23	24	23	23	23	24	23	23	24				
			fz	0.006	0.01	0.014	0.015	0.022	0.036	0.047	0.056	0.063	0.072	0.071	0.081	0.088	0.111				
			RPM	2069	1804	1592	1401	1273	915	764	610	523	458	424	366	333	306				
M	14.1	Stainless steel	0.1D	1.5D	Vc	20	27	32	35	37	36	37	37	37	37	36	37	37			
					fz	0.006	0.01	0.013	0.015	0.022	0.036	0.047	0.056	0.063	0.071	0.073	0.083	0.091	0.113		
					RPM	3183	2865	2546	2228	1963	1432	1178	981	841	736	654	573	535	471		
K	15-20	Grey cast iron Nodular cast iron Malleable cast iron	0.1D	1.5D	Vc	51	54	66	75	81	78	79	81	79	78	78	79	79			
					fz	0.004	0.008	0.012	0.015	0.023	0.035	0.046	0.056	0.063	0.071	0.077	0.081	0.094	0.109		
					RPM	8117	5730	5252	4775	4297	3104	2515	2149	1796	1552	1379	1257	1143	1006		
H	40	Chilled Cast Iron	0.05D	1.5D	Vc	13	17	20	22	24	23	24	23	23	23	24	23	23	24		
					fz	0.006	0.01	0.014	0.015	0.022	0.036	0.047	0.056	0.063	0.072	0.071	0.081	0.088	0.111		
					RPM	2069	1804	1592	1401	1273	915	764	610	523	458	424	366	333	306		

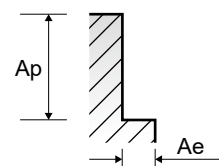



ONLY ONE
COATED PM60 END MILLS

RECOMMENDED CUTTING CONDITIONS
EMPFOHLENE SCHNEIDPARAMETER

GYG74, GYF96, GYG76, GYG02 SERIES 4 FLUTE - SIDE CUTTING

Vc = m/min.
fz = mm/tooth
RPM = rev./min.
FEED = mm/min.

ISO	VDI 3323	Material Description	Ae	Ap	Parameter	Diameter (Ø)															
						2.0	3.0	4.0	5.0	6.0	8.0	10.0	12.0	14.0	16.0	18.0	20.0	22.0	25.0		
P	1	Non-alloy steel	0.1D	1.5D	Vc	69	75	80	83	88	93	87	90	95	97	102	94	87	94		
					fz	0.008	0.015	0.023	0.029	0.035	0.046	0.068	0.071	0.076	0.079	0.076	0.088	0.097	0.093		
					RPM	10982	7958	6366	5284	4669	3700	2769	2387	2160	1930	1804	1496	1259	1197		
	FEED		351	477	586	613	654	681	753	678	657	610	548	527	488	445					
	2		Vc	63	68	71	75	81	78	79	81	84	84	85	79	79	79				
			fz	0.007	0.015	0.021	0.026	0.031	0.046	0.063	0.067	0.072	0.077	0.08	0.088	0.084	0.09				
			RPM	10027	7215	5650	4775	4297	3104	2515	2149	1910	1671	1503	1257	1143	1006				
	FEED		281	433	475	497	533	571	634	576	550	515	481	443	384	362					
	3-4		Vc	46	50	54	55	59	60	60	63	58	60	61	59	57	60				
			fz	0.007	0.014	0.021	0.028	0.032	0.046	0.059	0.066	0.08	0.085	0.086	0.088	0.093	0.09				
			RPM	7321	5305	4297	3501	3130	2387	1910	1671	1319	1194	1079	939	825	764				
FEED	205	297	361	392	401	439	451	441	422	406	371	331	307	275							
5	Vc	31	31	35	38	41	42	38	40	42	41	43	40	39	39						
	fz	0.008	0.017	0.022	0.028	0.032	0.043	0.067	0.068	0.072	0.081	0.077	0.082	0.085	0.09						
	RPM	4934	3289	2785	2419	2175	1671	1210	1061	955	816	760	637	564	497						
FEED	158	224	245	271	278	287	324	289	275	264	234	209	192	179							
6	Vc	63	68	71	75	81	78	79	81	84	84	85	79	79	79						
	fz	0.007	0.015	0.021	0.026	0.031	0.046	0.063	0.067	0.072	0.077	0.08	0.088	0.084	0.09						
	RPM	10027	7215	5650	4775	4297	3104	2515	2149	1910	1671	1503	1257	1143	1006						
FEED	281	433	475	497	533	571	634	576	550	515	481	443	384	362							
7	Vc	46	50	54	55	59	60	60	63	58	60	61	59	57	60						
	fz	0.007	0.014	0.021	0.028	0.032	0.046	0.059	0.066	0.08	0.085	0.086	0.088	0.093	0.09						
	RPM	7321	5305	4297	3501	3130	2387	1910	1671	1319	1194	1079	939	825	764						
FEED	205	297	361	392	401	439	451	441	422	406	371	331	307	275							
8	Vc	31	31	35	38	41	42	38	40	42	41	43	40	39	39						
	fz	0.008	0.017	0.022	0.028	0.032	0.043	0.067	0.068	0.072	0.081	0.077	0.082	0.085	0.09						
	RPM	4934	3289	2785	2419	2175	1671	1210	1061	955	816	760	637	564	497						
FEED	158	224	245	271	278	287	324	289	275	264	234	209	192	179							
9	Vc	25	27	30	32	33	35	34	32	33	33	34	33	33	34						
	fz	0.006	0.013	0.019	0.023	0.031	0.04	0.056	0.064	0.067	0.076	0.075	0.08	0.081	0.087						
	RPM	3979	2865	2387	2037	1751	1393	1082	849	750	657	601	525	477	433						
FEED	95	149	181	187	217	223	242	217	201	200	180	168	155	151							
10	Vc	63	68	71	75	81	78	79	81	84	84	85	79	79	79						
	fz	0.007	0.015	0.021	0.026	0.031	0.046	0.063	0.067	0.072	0.077	0.08	0.088	0.084	0.09						
	RPM	10027	7215	5650	4775	4297	3104	2515	2149	1910	1671	1503	1257	1143	1006						
FEED	281	433	475	497	533	571	634	576	550	515	481	443	384	362							
11.1	Vc	31	31	35	38	41	42	38	40	42	41	43	40	39	39						
	fz	0.008	0.017	0.022	0.028	0.032	0.043	0.067	0.068	0.072	0.081	0.077	0.082	0.085	0.09						
	RPM	4934	3289	2785	2419	2175	1671	1210	1061	955	816	760	637	564	497						
FEED	158	224	245	271	278	287	324	289	275	264	234	209	192	179							
11.2	Vc	17	19	21	22	23	24	24	23	23	23	24	23	23	24						
	fz	0.006	0.013	0.019	0.024	0.031	0.04	0.057	0.065	0.068	0.076	0.074	0.081	0.081	0.088						
	RPM	2706	2016	1671	1401	1220	955	764	610	523	458	424	366	333	306						
FEED	65	105	127	134	151	153	174	159	142	139	126	119	108	108							
M	14.1	Stainless steel	0.1D	1.5D	Vc	27	30	33	35	36	38	37	36	37	37	37	36	37	37		
					fz	0.006	0.013	0.019	0.023	0.031	0.039	0.056	0.063	0.067	0.075	0.076	0.08	0.08	0.088		
					RPM	4297	3183	2626	2228	1910	1512	1178	955	841	736	654	573	535	471		
FEED	103	166	200	205	237	236	264	241	225	221	199	183	171	166							
K	15-20	Grey cast iron Nodular cast iron Malleable cast iron	0.1D	1.5D	Vc	63	68	71	75	81	78	79	81	84	84	85	79	79	79		
					fz	0.007	0.015	0.021	0.026	0.031	0.046	0.063	0.067	0.072	0.077	0.08	0.088	0.084	0.09		
					RPM	10027	7215	5650	4775	4297	3104	2515	2149	1910	1671	1503	1257	1143	1006		
FEED	281	433	475	497	533	571	634	576	550	515	481	443	384	362							
H	40	Chilled Cast Iron	0.05D	1.5D	Vc	17	19	21	22	23	24	24	23	23	24	23	23	24			
					fz	0.006	0.013	0.019	0.024	0.031	0.04	0.057	0.065	0.068	0.076	0.074	0.081	0.081	0.088		
					RPM	2706	2016	1671	1401	1220	955	764	610	523	458	424	366	333	306		
FEED	65	105	127	134	151	153	174	159	142	139	126	119	108	108							

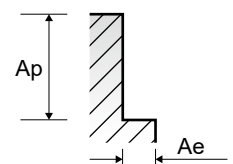

GYG52 SERIES**4 FLUTE - SLOTTING, SIDE CUTTING**

Vc = m/min.
 fz = mm/tooth
 RPM = rev./min.
 FEED = mm/min.

ISO	VDI 3323	Material Description	Slotting		Side Cutting		Parameter	Diameter (Ø)												
			Ae	Ap	Ae	Ap		3.0	4.0	5.0	6.0	8.0	10.0	12.0	14.0	16.0	18.0	20.0	25.0	
P	1-2	Non-alloy steel	1.0D	0.5D	0.3D	1.5D	Vc	70	70	70	70	70	77	77	77	77	77	77	77	77
							fz	0.005	0.008	0.012	0.016	0.028	0.039	0.047	0.049	0.053	0.059	0.065	0.063	
							RPM	7427	5570	4456	3714	2785	2451	2042	1751	1532	1362	1225	980	
	FEED		149	178	214	238	312	382	384	343	325	321	319	247						
	3-4		1.0D	0.5D	0.3D	1.5D	Vc	64	63	63	64	64	70	70	70	70	70	70	70	70
							fz	0.005	0.008	0.011	0.016	0.028	0.039	0.047	0.049	0.053	0.059	0.065	0.063	
							RPM	6791	5013	4011	3395	2546	2228	1857	1592	1393	1238	1114	891	
	FEED		136	160	176	217	285	348	349	312	295	292	290	225						
	5		1.0D	0.5D	0.3D	1.5D	Vc	44	44	44	44	44	49	49	49	49	49	49	49	49
							fz	0.005	0.008	0.011	0.016	0.028	0.038	0.047	0.05	0.052	0.059	0.066	0.065	
RPM		4669					3501	2801	2334	1751	1560	1300	1114	975	867	780	624			
FEED	93	112	123	149	196	237	244	223	203	204	206	162								
6	1.0D	0.5D	0.3D	1.5D	Vc	70	70	70	70	70	77	77	77	77	77	77	77	77		
					fz	0.005	0.008	0.012	0.016	0.028	0.039	0.047	0.049	0.053	0.059	0.065	0.063			
					RPM	7427	5570	4456	3714	2785	2451	2042	1751	1532	1362	1225	980			
FEED	149	178	214	238	312	382	384	343	325	321	319	247								
7	1.0D	0.5D	0.3D	1.5D	Vc	64	63	63	64	64	70	70	70	70	70	70	70	70		
					fz	0.005	0.008	0.011	0.016	0.028	0.039	0.047	0.049	0.053	0.059	0.065	0.063			
					RPM	6791	5013	4011	3395	2546	2228	1857	1592	1393	1238	1114	891			
FEED	136	160	176	217	285	348	349	312	295	292	290	225								
8	1.0D	0.5D	0.3D	1.5D	Vc	44	44	44	44	44	49	49	49	49	49	49	49	49		
					fz	0.005	0.008	0.011	0.016	0.028	0.038	0.047	0.05	0.052	0.059	0.066	0.065			
					RPM	4669	3501	2801	2334	1751	1560	1300	1114	975	867	780	624			
FEED	93	112	123	149	196	237	244	223	203	204	206	162								
9	1.0D	0.3D	0.15D	1.5D	Vc	27	27	27	27	27	30	29	29	30	29	30	29	29		
					fz	0.004	0.007	0.01	0.014	0.024	0.032	0.04	0.041	0.044	0.05	0.056	0.054			
					RPM	2865	2149	1719	1432	1074	955	769	659	597	513	477	369			
FEED	46	60	69	80	103	122	123	108	105	103	107	80								
10	1.0D	0.5D	0.3D	1.5D	Vc	70	70	70	70	70	77	77	77	77	77	77	77	77		
					fz	0.005	0.008	0.012	0.016	0.028	0.039	0.047	0.049	0.053	0.059	0.065	0.063			
					RPM	7427	5570	4456	3714	2785	2451	2042	1751	1532	1362	1225	980			
FEED	149	178	214	238	312	382	384	343	325	321	319	247								
11.1	1.0D	0.5D	0.3D	1.5D	Vc	44	44	44	44	44	49	49	49	49	49	49	49	49		
					fz	0.005	0.008	0.011	0.016	0.028	0.038	0.047	0.05	0.052	0.059	0.066	0.065			
					RPM	4669	3501	2801	2334	1751	1560	1300	1114	975	867	780	624			
FEED	93	112	123	149	196	237	244	223	203	204	206	162								
11.2	1.0D	0.3D	0.15D	1.5D	Vc	27	27	27	27	27	30	29	29	30	29	30	29	29		
					fz	0.004	0.007	0.01	0.014	0.024	0.032	0.04	0.041	0.044	0.05	0.056	0.054			
					RPM	2865	2149	1719	1432	1074	955	769	659	597	513	477	369			
FEED	46	60	69	80	103	122	123	108	105	103	107	80								
M	14.1	Stainless steel	1.0D	0.5D	0.3D	1.5D	Vc	48	48	48	48	48	48	48	48	48	48	48	48	
							fz	0.005	0.008	0.013	0.018	0.029	0.048	0.056	0.06	0.063	0.071	0.077	0.078	
							RPM	5093	3820	3056	2546	1910	1528	1273	1091	955	849	764	611	
FEED	102	122	159	183	222	293	285	262	241	241	235	191								
K	15-20	Grey cast iron Nodular cast iron Malleable cast iron	1.0D	0.5D	0.3D	1.5D	Vc	70	70	70	70	70	77	77	77	77	77	77	77	
							fz	0.005	0.008	0.012	0.016	0.028	0.039	0.047	0.049	0.053	0.059	0.065	0.063	
							RPM	7427	5570	4456	3714	2785	2451	2042	1751	1532	1362	1225	980	
FEED	149	178	214	238	312	382	384	343	325	321	319	247								
H	40	Chilled Cast Iron	1.0D	0.3D	0.15D	1.5D	Vc	27	27	27	27	27	30	29	29	30	29	30	29	
							fz	0.004	0.007	0.01	0.014	0.024	0.032	0.04	0.041	0.044	0.05	0.056	0.054	
							RPM	2865	2149	1719	1432	1074	955	769	659	597	513	477	369	
FEED	46	60	69	80	103	122	123	108	105	103	107	80								

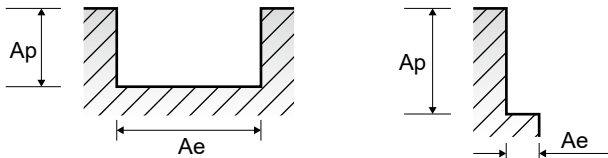



ONLY ONE
COATED PM60 END MILLS

RECOMMENDED CUTTING CONDITIONS
EMPFOHLENE SCHNEIDPARAMETER

GYF95 SERIES

MULTI FLUTE ROUGHING - SIDE CUTTING

Vc = m/min.
fz = mm/tooth
RPM = rev./min.
FEED = mm/min.

ISO	VDI 3323	Material Description	Ae	Ap	Parameter	6.0	8.0	10.0	12.0	14.0	16.0	18.0	20.0	25.0	
						Vc	fz	RPM	FEED	Vc	fz	RPM	FEED	Vc	fz
P	1	Non-alloy steel	0.5D	1.5D	Vc	76	87	86	87	89	87	85	87	90	
					fz	0.02	0.03	0.055	0.065	0.059	0.069	0.079	0.088	0.105	
					RPM	4032	3462	2737	2308	2024	1731	1503	1385	1146	
	2		Vc	60	69	68	65	66	69	72	68	68			
			fz	0.021	0.03	0.053	0.069	0.063	0.069	0.074	0.087	0.106			
			RPM	3183	2745	2165	1724	1501	1373	1273	1082	866			
	3		Vc	43	51	47	49	48	48	50	48	47			
			fz	0.018	0.028	0.046	0.063	0.061	0.069	0.075	0.086	0.107			
			RPM	2281	2029	1496	1300	1091	955	884	764	598			
	4		Vc	43	51	47	49	48	48	50	48	47			
			fz	0.018	0.028	0.046	0.063	0.061	0.069	0.075	0.086	0.107			
			RPM	2281	2029	1496	1300	1091	955	884	764	598			
5	Vc	35	38	40	40	40	40	40	40	41					
	fz	0.02	0.03	0.045	0.061	0.057	0.066	0.073	0.081	0.1					
	RPM	1857	1512	1273	1061	909	796	707	637	522					
6	Vc	60	69	68	65	66	69	72	68	68					
	fz	0.021	0.03	0.053	0.069	0.063	0.069	0.074	0.087	0.106					
	RPM	3183	2745	2165	1724	1501	1373	1273	1082	866					
7	Vc	43	51	47	49	48	48	50	48	47					
	fz	0.018	0.028	0.046	0.063	0.061	0.069	0.075	0.086	0.107					
	RPM	2281	2029	1496	1300	1091	955	884	764	598					
8-9	Vc	35	38	40	40	40	40	40	40	41					
	fz	0.02	0.03	0.045	0.061	0.057	0.066	0.073	0.081	0.1					
	RPM	1857	1512	1273	1061	909	796	707	637	522					
10	Vc	60	69	68	65	66	69	72	68	68					
	fz	0.021	0.03	0.053	0.069	0.063	0.069	0.074	0.087	0.106					
	RPM	3183	2745	2165	1724	1501	1373	1273	1082	866					
11.1	Vc	35	38	40	40	40	40	40	40	41					
	fz	0.02	0.03	0.045	0.061	0.057	0.066	0.073	0.081	0.1					
	RPM	1857	1512	1273	1061	909	796	707	637	522					
11.2	Vc	25	27	28	28	28	28	28	28	28					
	fz	0.02	0.029	0.044	0.06	0.056	0.065	0.072	0.08	0.1					
	RPM	1326	1074	891	743	637	557	495	446	357					
M	14.1	Stainless steel	0.5D	1.5D	Vc	39	43	43	43	44	43	45	44	44	
					fz	0.019	0.03	0.045	0.064	0.059	0.069	0.075	0.084	0.104	
					RPM	2069	1711	1369	1141	1000	855	796	700	560	
K	15-20	Grey cast iron Nodular cast iron Malleable cast iron	0.5D	1.5D	Vc	60	69	68	65	66	69	72	68	68	
					fz	0.021	0.03	0.053	0.069	0.063	0.069	0.074	0.087	0.106	
					RPM	3183	2745	2165	1724	1501	1373	1273	1082	866	
H	40	Chilled Cast Iron	0.3D	1.5D	Vc	25	27	28	28	28	28	28	28	28	
					fz	0.02	0.029	0.044	0.06	0.056	0.065	0.072	0.08	0.1	
					RPM	1326	1074	891	743	637	557	495	446	357	

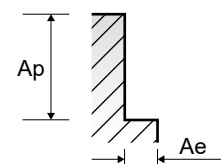

GYF94, GYF98, GYG03 SERIES MULTI FLUTE ROUGHING - SIDE CUTTING

 Vc = m/min.
 fz = mm/tooth
 RPM = rev./min.
 FEED = mm/min.

ISO	VDI 3323	Material Description	Ae	Ap	Parameter	Diameter (Ø)								
						6.0	8.0	10.0	12.0	14.0	16.0	18.0	20.0	25.0
P	1	Non-alloy steel	0.5D	1.5D	Vc	63	72	72	72	74	72	71	72	75
					fz	0.027	0.041	0.055	0.065	0.074	0.087	0.099	0.111	0.105
					RPM	3342	2865	2292	1910	1682	1432	1256	1146	955
					FEED	271	352	504	497	498	498	509	501	
	2		0.5D	1.5D	Vc	50	57	57	54	55	57	61	57	57
					fz	0.027	0.04	0.053	0.069	0.078	0.087	0.092	0.109	0.106
					RPM	2653	2268	1814	1432	1251	1134	1079	907	726
					FEED	215	272	385	395	390	395	397	396	385
	3-4		0.5D	1.5D	Vc	36	42	40	41	40	40	41	40	39
					fz	0.024	0.038	0.047	0.064	0.076	0.087	0.094	0.107	0.106
					RPM	1910	1671	1273	1088	909	796	725	637	497
					FEED	138	191	239	278	276	277	273	272	263
5	0.5D	1.5D	Vc	29	32	34	34	33	33	33	33	34		
			fz	0.027	0.04	0.044	0.06	0.071	0.081	0.091	0.101	0.1		
			RPM	1538	1273	1082	902	750	657	584	525	433		
			FEED	125	153	190	216	213	213	212	212	216		
6	0.5D	1.5D	Vc	50	57	57	54	55	57	61	57	57		
			fz	0.027	0.04	0.053	0.069	0.078	0.087	0.092	0.109	0.106		
			RPM	2653	2268	1814	1432	1251	1134	1079	907	726		
			FEED	215	272	385	395	390	395	397	396	385		
7	0.5D	1.5D	Vc	36	42	40	41	40	40	41	40	39		
			fz	0.024	0.038	0.047	0.064	0.076	0.087	0.094	0.107	0.106		
			RPM	1910	1671	1273	1088	909	796	725	637	497		
			FEED	138	191	239	278	276	277	273	272	263		
8-9	0.5D	1.5D	Vc	29	32	34	34	33	33	33	33	34		
			fz	0.027	0.04	0.044	0.06	0.071	0.081	0.091	0.101	0.1		
			RPM	1538	1273	1082	902	750	657	584	525	433		
			FEED	125	153	190	216	213	213	212	212	216		
10	0.5D	1.5D	Vc	50	57	57	54	55	57	61	57	57		
			fz	0.027	0.04	0.053	0.069	0.078	0.087	0.092	0.109	0.106		
			RPM	2653	2268	1814	1432	1251	1134	1079	907	726		
			FEED	215	272	385	395	390	395	397	396	385		
11.1	0.5D	1.5D	Vc	29	32	34	34	33	33	33	33	34		
			fz	0.027	0.04	0.044	0.06	0.071	0.081	0.091	0.101	0.1		
			RPM	1538	1273	1082	902	750	657	584	525	433		
			FEED	125	153	190	216	213	213	212	212	216		
11.2	0.3D	1.5D	Vc	21	22	24	23	23	23	23	23	24		
			fz	0.028	0.04	0.045	0.06	0.071	0.082	0.091	0.101	0.1		
			RPM	1114	875	764	610	523	458	407	366	306		
			FEED	94	105	138	146	149	150	148	148	153		
M	14.1	Stainless steel	0.5D	1.5D	Vc	33	36	36	36	37	36	37	36	37
					fz	0.025	0.039	0.045	0.064	0.074	0.085	0.093	0.106	0.102
					RPM	1751	1432	1146	955	841	716	654	573	471
					FEED	131	168	206	244	249	244	243	243	240
K	15-20	Grey cast iron Nodular cast iron Malleable cast iron	0.5D	1.5D	Vc	50	57	57	54	55	57	61	57	57
					fz	0.027	0.04	0.053	0.069	0.078	0.087	0.092	0.109	0.106
					RPM	2653	2268	1814	1432	1251	1134	1079	907	726
					FEED	215	272	385	395	390	395	397	396	385
H	40	Chilled Cast Iron	0.3D	1.5D	Vc	21	22	24	23	23	23	23	23	24
					fz	0.028	0.04	0.045	0.06	0.071	0.082	0.091	0.101	0.1
					RPM	1114	875	764	610	523	458	407	366	306
					FEED	94	105	138	146	149	150	148	148	153

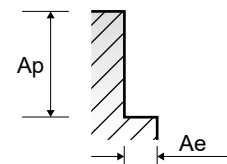



Global Cutting Tool Leader **YG-1**



MILLING



Leading Through Innovation



HSS-PM

TANK-POWER END MILLS

TANK - POWER HSS-PM - Fräser

- High Toughness for Stainless Steels, Carbon steels and Alloy Steels
- Hohe Zähigkeit, für rostfreie Stähle, Kohlenstoffstähle und legierte Stähle

SELECTION GUIDE



SERIES	E9940 GA940	E9A32 GAA32	E9936 GA936	E9A29 GAA29
FLUTE	2	2	2	2
HELIX ANGLE	30°	30°	30°	30°
CUTTING EDGE SHAPE	BALL NOSE	BALL NOSE	SQUARE	SQUARE
SIZE MIN	R0.5	R1.0	D1.0	D1.0
SIZE MAX	R12.5	R12.5	D25.0	D25.0
PAGE	640	641	642	643

SHORT LENGTH	LONG LENGTH	SHORT LENGTH	LONG LENGTH
TiAlN based	TiAlN based	TiAlN based	TiAlN based

HSS-PM TANK-POWER END MILLS

High Toughness, for Stainless Steels, Carbon steels, Alloy Steels
For General Application, Rough & Finish

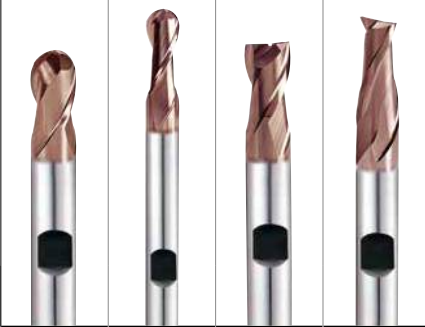

Please visit globalyg1.com/mat for material search

◎ : Excellent ○ : Good

Recommended cutting conditions : P 654

ISO	VDI 3323	Material Description	Composition / Structure / Heat Treatment	HB	HRc					
P	1	Non-alloy steel	About 0.15% C Annealed	125		◎	◎	◎	◎	
	2		About 0.45% C Annealed	190	13	◎	◎	◎	◎	
	3		About 0.45% C Quenched & Tempered	250	25	◎	◎	◎	◎	
	4		About 0.75% C Annealed	270	28	◎	◎	◎	◎	
	5		About 0.75% C Quenched & Tempered	300	32	◎	◎	◎	◎	
	6	Low alloy steel	Annealed	180	10	◎	◎	◎	◎	
	7		Quenched & Tempered	275	29	◎	◎	◎	◎	
	8		Quenched & Tempered	300	32	◎	◎	◎	◎	
	9		Quenched & Tempered	350	38	○	○	○	○	
	10		High alloyed steel, and tool steel	Annealed	200	15	◎	◎	◎	◎
	11			Quenched & Tempered	325	35	○	○	○	○
M	12	Stainless steel	Ferritic / Martensitic Annealed	200	15	◎	◎	◎	◎	
	13		Martensitic Quenched & Tempered	240	23	◎	◎	◎	◎	
	14		Austenitic	180	10	◎	◎	◎	◎	
K	15	Grey cast iron	Pearlitic / ferritic	180	10	◎	◎	◎	◎	
	16		Pearlitic (Martensitic)	260	26	◎	◎	◎	◎	
	17	Nodular cast iron	Ferritic	160	3	◎	◎	◎	◎	
	18		Pearlitic	250	25	◎	◎	◎	◎	
	19		Ferritic	130		◎	◎	◎	◎	
	20	Malleable cast iron	Pearlitic	230	21	◎	◎	◎	◎	
N	21	Aluminum-wrought alloy	Not Curable	60						
	22		Curable Hardened	100						
	23		≤ 12% Si, Not Curable	75						
	24	Aluminum-cast, alloyed	≤ 12% Si, Curable Hardened	90						
	25		> 12% Si, Not Curable	130						
	26		Copper and Copper Alloys	Cutting Alloys, PB>1%	110		○	○	○	○
	27		CuZn, CuSnZn (Brass)	90		○	○	○	○	
	28	Non Metallic Materials	CuSn, lead-free copper and electrolytic copper	100		○	○	○	○	
	29		Duroplastic, Fiber Reinforced Plastic							
	30	Rubber, Wood, etc.								
S	31	Heat Resistant Super Alloys	Fe Based Annealed	200	15					
	32		Fe Based Cured	280	30					
	33		Fe Based Annealed	250	25					
	34		Ni or Co Based Cured	350	38					
	35	Ni or Co Based Cast	320	34						
	36	Titanium Alloys	Pure Titanium	400 Rm						
	37		Alpha + Beta Alloys Hardened	1050 Rm						
H	38	Hardened steel	Hardened	550	55					
	39		Hardened	630	60					
	40	Chilled Cast Iron	Cast	400	42					
	41	Hardened Cast Iron	Hardened	550	55					

E9942 GA942	E9A30 GAA30	E9938 GA938	E9A31 GAA31	E9941 GA941	E9A35 GAA35	E9A26 GAA26	E9A33 GAA33	E9A34 GAA34	E9E43 GAE43
3	3	4	4	Multi Flute	Multi Flute	Multi Flute	Multi Flute	Multi Flute	Multi Flute
30°	30°	30°	30°	30°	30°	45°	30°	30°	30°
SQUARE	SQUARE	SQUARE	SQUARE	ROUGHING	ROUGHING	ROUGHING	ROUGHING	ROUGHING	ROUGHING
D1.0	D1.0	D1.0	D2.0	D6.0	D6.0	D4.0	D6.0	D6.0	D10.0
D25.0	D25.0	D25.0	D25.0	D25.0	D25.0	D25.0	D25.0	D25.0	D25.0
644	645	646	647	648	649	650	651	652	653
STUB LENGTH	SHORT LENGTH	SHORT LENGTH	LONG LENGTH	SHORT LENGTH	LONG LENGTH	SHORT LENGTH	SHORT LENGTH	LONG LENGTH	WITH NECK
TiAlN based	TiAlN based	TiAlN based	TiAlN based	X-Coating	X-Coating	X-Coating	X-Coating	X-Coating	X-Coating



⊙	⊙	⊙	⊙	⊙	⊙	⊙	⊙	⊙	⊙	1
⊙	⊙	⊙	⊙	⊙	⊙	⊙	⊙	⊙	⊙	2
⊙	⊙	⊙	⊙	⊙	⊙	⊙	⊙	⊙	⊙	3
⊙	⊙	⊙	⊙	⊙	⊙	⊙	⊙	⊙	⊙	4
⊙	⊙	⊙	⊙	⊙	⊙	⊙	⊙	⊙	⊙	5
⊙	⊙	⊙	⊙	⊙	⊙	⊙	⊙	⊙	⊙	6 P
⊙	⊙	⊙	⊙	⊙	⊙	⊙	⊙	⊙	⊙	7
⊙	⊙	⊙	⊙	⊙	⊙	⊙	⊙	⊙	⊙	8
○	○	○	○	○	○	○	○	○	○	9
⊙	⊙	⊙	⊙	⊙	⊙	⊙	⊙	⊙	⊙	10
○	○	○	○	○	○	○	○	○	○	11
⊙	⊙	⊙	⊙	⊙	⊙	⊙	⊙	⊙	⊙	12
⊙	⊙	⊙	⊙	⊙	⊙	⊙	⊙	⊙	⊙	13 M
⊙	⊙	⊙	⊙	⊙	⊙	⊙	⊙	⊙	⊙	14
⊙	⊙	⊙	⊙	⊙	⊙	⊙	⊙	⊙	⊙	15
⊙	⊙	⊙	⊙	⊙	⊙	⊙	⊙	⊙	⊙	16
⊙	⊙	⊙	⊙	⊙	⊙	⊙	⊙	⊙	⊙	17 K
⊙	⊙	⊙	⊙	⊙	⊙	⊙	⊙	⊙	⊙	18
⊙	⊙	⊙	⊙	⊙	⊙	⊙	⊙	⊙	⊙	19
⊙	⊙	⊙	⊙	⊙	⊙	⊙	⊙	⊙	⊙	20
										21
										22
										23
										24
										25
○	○	○	○	○	○	○	○	○	○	26 N
○	○	○	○	○	○	○	○	○	○	27
○	○	○	○	○	○	○	○	○	○	28
										29
										30
										31
										32
										33
										34 S
										35
										36
										37
										38
										39 H
										40
										41

CBN
END MILLS

i-Xmill
END MILLS

i-SMART
MODULAR
END MILLS

X5070
END MILLS

4G MILL
END MILLS

X-POWER
PRO
END MILLS

TitaNox-
POWER
END MILLS

JET-POWER
END MILLS

V7 PLUS
END MILLS

ALU-POWER
HPC
END MILLS

ALU-
POWER
END MILLS

D-POWER
GRAPHITE
END MILLS

D-POWER
CFRP
END MILLS

ROUTERS

CRX S
END MILLS

K-2
END MILLS

ONLY ONE
COATED PM60
END MILLS

TANK-
POWER
END MILLS

GENERAL
HSS
END MILLS

MILLING
CUTTERS

TECHNICAL
DATA



UNCOATED

E9940 SERIES

TiAlN based COATED

GA940 SERIES

HSS-PM, 2 FLUTE SHORT LENGTH BALL NOSE

- HSS-PM, 2 SCHNEIDEN KURZ STIRNRADIUS
- FRAISES HSS-PM, 2 DENTS À BOUT HÉMISPHERIQUE, SÉRIE COURTE
- 2 TAGLIENTI, SERIE CORTA, HSS-PM, SEMISFERICA

- ▶ Designed to machine carbon steels, alloyed steels, stainless steels.
- ▶ Designed for milling of radius bottom slots, fillets and special contours.
- ▶ YG-1's new developed TANK-POWER Coating suitable for high speed cutting.
- ▶ Geeignet zum Fräsen von Stahl, legiertem Stahl und rostfreier Stahl.
- ▶ Entworfen zum Fräsen von Nuten mit Radien, Rippen und speziellen Konturen.
- ▶ Neuentwickelte Beschichtung für Hochgeschwindigkeitsfräsen.



HSS PM
DIN 327
2
30°
R ±0.02
DIN 1835B
P.654~655

Unit : mm

EDP No.		Radius of Ball Nose	Mill Diameter	Shank Diameter	Length of Cut	Overall Length
UNCOATED	TiAlN based	R(±0.02)				
E9940010	GA940010	R0.5	1.0	6	2.5	47
E9940020	GA940020	R1.0	2.0	6	4	48
E9940030	GA940030	R1.5	3.0	6	5	49
E9940040	GA940040	R2.0	4.0	6	7	51
E9940050	GA940050	R2.5	5.0	6	8	52
E9940060	GA940060	R3.0	6.0	6	8	52
E9940070	GA940070	R3.5	7.0	10	10	60
E9940080	GA940080	R4.0	8.0	10	11	61
E9940090	GA940090	R4.5	9.0	10	11	61
E9940100	GA940100	R5.0	10.0	10	13	63
E9940120	GA940120	R6.0	12.0	12	16	73
E9940140	GA940140	R7.0	14.0	12	16	73
E9940160	GA940160	R8.0	16.0	16	19	79
E9940180	GA940180	R9.0	18.0	16	19	79
E9940200	GA940200	R10.0	20.0	20	22	88
E9940220	GA940220	R11.0	22.0	20	22	88
E9940250	GA940250	R12.5	25.0	25	26	102

Mill Dia. Tolerance (mm)	Shank Dia. Tolerance
0 ~ -0.03	h6

◎ : Excellent ○ : Good

ISO Material Description	P											M			K					
	Non-alloy steel					Low alloy steel				High alloyed steel, and tool steel		Stainless steel			Grey cast iron		Nodular cast iron	Malleable cast iron		
VDI 3323	1	2	3	4	5	6	7	8	9	10	11	12	13	14	15	16	17	18	19	20
HRc		13	25	28	32	10	29	32	38	15	35	15	23	10	10	26	3	25		21
HB	125	190	250	270	300	180	275	300	350	200	325	200	240	180	180	260	160	250	130	230
Recommend	◎	◎	◎	◎	◎	◎	◎	◎	○	◎	○	◎	◎	◎	◎	◎	◎	◎	◎	◎

ISO Material Description	N										S					H					
	Aluminum-wrought alloy		Aluminum-cast, alloyed			Copper and Copper Alloys (Bronze / Brass)		Non Metallic Materials			Heat Resistant Super Alloys					Titanium Alloys		Hardened steel	Chilled Cast Iron	Hardened Cast Iron	
VDI 3323	21	22	23	24	25	26	27	28	29	30	31	32	33	34	35	36	37	38	39	40	41
HRc											15	30	25	38	34			55	60	42	55
HB	60	100	75	90	130	110	90	100			200	280	250	350	320	400 Rm	1050 Rm	550	630	400	550
Recommend						○	○	○													

HSS-PM, 2 FLUTE LONG LENGTH BALL NOSE

- HSS-PM, 2 SCHNEIDEN LANG STIRNRADIUS
- FRAISES HSS-PM, 2 DENTS À BOUT HÉMISPHERIQUE, SÉRIE LONGUE
- 2 TAGLIENTI, SERIE LUNGA, HSS-PM, SEMISFERICA

- ▶ Designed to machine carbon steels, alloyed steels, stainless steels.
- ▶ Designed for milling of radius bottom slots, fillets and special contours.
- ▶ YG-1's new developed TANK-POWER Coating suitable for high speed cutting.
- ▶ Geeignet zum Fräsen von Stahl, legiertem Stahl und rostfreier Stahl.
- ▶ Entworfen zum Fräsen von Nuten mit Radien, Rippen und speziellen Konturen.
- ▶ Neuentwickelte Beschichtung für Hochgeschwindigkeitsfräsen.



HSS PM
DIN 1889
2
30°
R ±0.02
DIN 1835B
P.654~655

Unit : mm

EDP No.		Radius of Ball Nose	Mill Diameter	Shank Diameter	Length of Cut	Overall Length
UNCOATED	TiAIN based	R(±0.02)				
E9A32020	GAA32020	R1.0	2.0	6	7	54
E9A32030	GAA32030	R1.5	3.0	6	8	56
E9A32040	GAA32040	R2.0	4.0	6	11	63
E9A32050	GAA32050	R2.5	5.0	6	13	68
E9A32060	GAA32060	R3.0	6.0	6	13	68
E9A32070	GAA32070	R3.5	7.0	10	16	80
E9A32080	GAA32080	R4.0	8.0	10	19	88
E9A32090	GAA32090	R4.5	9.0	10	19	88
E9A32100	GAA32100	R5.0	10.0	10	22	95
E9A32120	GAA32120	R6.0	12.0	12	26	110
E9A32140	GAA32140	R7.0	14.0	12	26	110
E9A32160	GAA32160	R8.0	16.0	16	32	123
E9A32180	GAA32180	R9.0	18.0	16	32	123
E9A32200	GAA32200	R10.0	20.0	20	38	141
E9A32220	GAA32220	R11.0	22.0	20	38	141
E9A32250	GAA32250	R12.5	25.0	25	45	166

Mill Dia. Tolerance (mm)	Shank Dia. Tolerance
0 ~ - 0.03	h6

◎ : Excellent ○ : Good

ISO Material Description	P										M				K						
	Non-alloy steel					Low alloy steel					High alloyed steel, and tool steel				Stainless steel		Grey cast iron		Nodular cast iron		Malleable cast iron
VDI 3323	1	2	3	4	5	6	7	8	9	10	11	12	13	14	15	16	17	18	19	20	
HRc	13	25	28	32	10	29	32	38	15	35	15	23	10	10	26	3	25	130	21		
HB	125	190	250	270	300	180	275	300	350	200	325	200	240	180	180	260	160	250	130	230	
Recommend	◎	◎	◎	◎	◎	◎	◎	◎	○	◎	○	◎	◎	◎	◎	◎	◎	◎	◎	◎	

ISO Material Description	N					S										H					
	Aluminum-wrought alloy		Aluminum-cast, alloyed			Copper and Copper Alloys (Bronze / Brass)			Non Metallic Materials		Heat Resistant Super Alloys					Titanium Alloys		Hardened steel	Chilled Cast Iron	Hardened Cast Iron	
VDI 3323	21	22	23	24	25	26	27	28	29	30	31	32	33	34	35	36	37	38	39	40	41
HRc	60	100	75	90	130	110	90	100			15	30	25	38	34	55	60	55	60	42	55
HB	60	100	75	90	130	110	90	100			200	280	250	350	320	400 Rm	1050 Rm	550	630	400	550
Recommend						○	○	○													



UNCOATED **E9936** SERIES
 TiAlN based COATED **GA936** SERIES

HSS-PM, 2 FLUTE SHORT LENGTH

- HSS-PM, 2 SCHNEIDEN KURZ
- FRAISES HSS-PM, 2 DENTS, SÉRIE COURTE
- 2 TAGLIANTI, SERIE CORTA, HSS-PM

- ▶ Designed to machine carbon steels, alloyed steels, stainless steels.
- ▶ 2 Flute design for slotting.
- ▶ Suitable for high speed cutting of difficult-to-cut materials.
- ▶ YG-1's new developed TANK-POWER Coating suitable for high speed cutting.

- ▶ Geeignet zum Fräsen von Stahl, legiertem Stahl und rostfreier Stahl.
- ▶ 2 Schneiden, Geeignet für Nutenfräsen.
- ▶ Geeignet für Hochgeschwindigkeitsfräsen von schwer zu zerspanenden Materialien.
- ▶ Neuentwickelte Beschichtung für Hochgeschwindigkeitsfräsen.

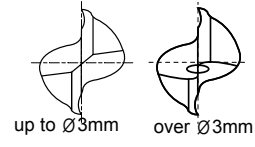

HSS PM
DIN 327
2
30°
DIN 1835B
P.656~657

EDP No.		Mill Diameter	Shank Diameter	Length of Cut	Overall Length
UNCOATED	TiAlN based	e8	h6		
E9936010	GA936010	1.0	6	2.5	47
E9936020	GA936020	2.0	6	4	48
E9936030	GA936030	3.0	6	5	49
E9936040	GA936040	4.0	6	7	51
E9936050	GA936050	5.0	6	8	52
E9936060	GA936060	6.0	6	8	52
E9936070	GA936070	7.0	10	10	60
E9936080	GA936080	8.0	10	11	61
E9936090	GA936090	9.0	10	11	61
E9936100	GA936100	10.0	10	13	63
E9936120	GA936120	12.0	12	16	73
E9936140	GA936140	14.0	12	16	73
E9936160	GA936160	16.0	16	19	79
E9936180	GA936180	18.0	16	19	79
E9936200	GA936200	20.0	20	22	88
E9936220	GA936220	22.0	20	22	88
E9936250	GA936250	25.0	25	26	102

Tolerances according to DIN 7160 & 7161

Tolerance range in μm					
Nominal-Diameter in mm					
	from 1 to 3	over 3 to 6	over 6 to 10	over 10 to 18	over 18 to 30
e8	- 14 - 28	- 20 - 38	- 25 - 47	- 32 - 59	- 40 - 73
h6	0 - 6	0 - 8	0 - 9	0 - 11	0 - 13

◎ : Excellent ○ : Good

ISO Material Description	P										M					K						
	Non-alloy steel					Low alloy steel					High alloyed steel, and tool steel					Stainless steel			Grey cast iron		Nodular cast iron	
VDI 3323	1	2	3	4	5	6	7	8	9	10	11	12	13	14	15	16	17	18	19	20		
HRc		13	25	28	32	10	29	32	38	15	35	15	23	10	10	26	3	25		21		
HB	125	190	250	270	300	180	275	300	350	200	325	200	240	180	180	260	160	250	130	230		
Recommend	◎	◎	◎	◎	◎	◎	◎	◎	○	◎	○	◎	◎	◎	◎	◎	◎	◎	◎	◎		

ISO Material Description	N										S					H					
	Aluminum-wrought alloy		Aluminum-cast, alloyed			Copper and Copper Alloys (Bronze / Brass)			Non Metallic Materials		Heat Resistant Super Alloys					Titanium Alloys		Hardened steel	Chilled Cast Iron		Hardened Cast Iron
VDI 3323	21	22	23	24	25	26	27	28	29	30	31	32	33	34	35	36	37	38	39	40	41
HRc											15	30	25	38	34			55	60	42	55
HB	60	100	75	90	130	110	90	100			200	280	250	350	320	400 Rm	1050 Rm	550	630	400	550
Recommend						○	○	○													

HSS-PM, 2 FLUTE LONG LENGTH

- HSS-PM, 2 SCHNEIDEN LANG
- FRAISES HSS-PM, 2 DENTS, SÉRIE LONGUE
- 2 TAGLIENTI, SERIE LUNGA, HSS-PM

- ▶ Designed to machine carbon steels, alloyed steels, stainless steels.
- ▶ 2 Flute design for slotting.
- ▶ Suitable for high speed cutting of difficult-to-cut materials.
- ▶ YG-1's new developed TANK-POWER Coating suitable for high speed cutting.

- ▶ Geeignet zum Fräsen von Stahl, legiertem Stahl und rostfreier Stahl.
- ▶ 2 Schneiden, Geeignet für Nutenfräsen.
- ▶ Geeignet für Hochgeschwindigkeitsfräsen von schwer zu zerspanenden Materialien.
- ▶ Neuentwickelte Beschichtung für Hochgeschwindigkeitsfräsen.

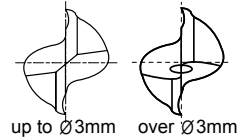

HSS PM
DIN 844
2
30°
DIN 1835B
P.656~657

Unit : mm

EDP No.		Mill Diameter	Shank Diameter	Length of Cut	Overall Length
UNCOATED	TiAIN based	e8	h6		
E9A29010	GAA29010	1.0	6	3	47
E9A29020	GAA29020	2.0	6	7	51
E9A29030	GAA29030	3.0	6	8	52
E9A29040	GAA29040	4.0	6	11	55
E9A29050	GAA29050	5.0	6	13	57
E9A29060	GAA29060	6.0	6	13	57
E9A29070	GAA29070	7.0	10	16	66
E9A29080	GAA29080	8.0	10	19	69
E9A29090	GAA29090	9.0	10	19	69
E9A29100	GAA29100	10.0	10	22	72
E9A29120	GAA29120	12.0	12	26	83
E9A29140	GAA29140	14.0	12	26	83
E9A29160	GAA29160	16.0	16	32	92
E9A29180	GAA29180	18.0	16	32	92
E9A29200	GAA29200	20.0	20	38	104
E9A29220	GAA29220	22.0	20	38	104
E9A29250	GAA29250	25.0	25	45	121

Tolerances according to DIN 7160 & 7161

Tolerance range in μm					
Nominal-Diameter in mm					
	from 1 to 3	over 3 to 6	over 6 to 10	over 10 to 18	over 18 to 30
e8	- 14 - 28	- 20 - 38	- 25 - 47	- 32 - 59	- 40 - 73
h6	0 - 6	0 - 8	0 - 9	0 - 11	0 - 13

◎ : Excellent ○ : Good

ISO Material Description	P										M				K						
	Non-alloy steel					Low alloy steel					High alloyed steel, and tool steel				Stainless steel		Grey cast iron		Nodular cast iron		Malleable cast iron
VDI 3323	1	2	3	4	5	6	7	8	9	10	11	12	13	14	15	16	17	18	19	20	
HRC		13	25	28	32	10	29	32	38	15	35	15	23	10	10	26	3	25	3	21	
HB	125	190	250	270	300	180	275	300	350	200	325	200	240	180	180	260	160	250	130	230	
Recommend	◎	◎	◎	◎	◎	◎	◎	◎	◎	◎	◎	◎	◎	◎	◎	◎	◎	◎	◎	◎	
ISO Material Description	N										S						H				
	Aluminum-wrought alloy		Aluminum-cast, alloyed			Copper and Copper Alloys (Bronze / Brass)			Non Metallic Materials		Heat Resistant Super Alloys						Titanium Alloys		Hardened steel	Chilled Cast Iron	Hardened Cast Iron
VDI 3323	21	22	23	24	25	26	27	28	29	30	31	32	33	34	35	36	37	38	39	40	41
HRC	60	100	75	90	130	110	90	100			200	280	250	350	320	400Rm	1050Rm	550	630	400	550
HB											15	30	25	38	34			55	60	42	55
Recommend						○	○	○													



UNCOATED

E9942 SERIES

TiAlN based COATED

GA942 SERIES

HSS-PM, 3 FLUTE STUB LENGTH

- **HSS-PM, 3 SCHNEIDEN EXTRA KURZ**
- **FRAISES HSS-PM, 3 DENTS, SÉRIE EXTRA-COURTE**
- **3 TAGLIANTI, SERIE EXTRA CORTA, HSS-PM**

- ▶ Designed to machine carbon steels, alloyed steels, stainless steels.
- ▶ Well balanced web design to minimize deflection and chattering.
- ▶ 3 flute design possess the advantage of 2 flute and 4 flute end mill.
- ▶ YG-1's new developed TANK-POWER Coating suitable for high speed cutting.

- ▶ Geeignet zum Fräsen von Stahl, legiertem Stahl und rostfreier Stahl.
- ▶ Verstärkter Kern zur Erhöhung der Stabilität.
- ▶ 3 Schneiden Design besitzt die Vorteile von 2-bzw 4 Schneiden Fräsern.
- ▶ Neuentwickelte Beschichtung für Hochgeschwindigkeitsfräsen.

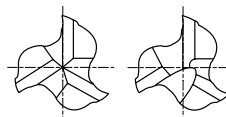

up to Ø1mm over Ø1mm

HSS PM
DIN 327
3
30°
DIN 1835B
p.658 ~ 661

Unit : mm

EDP No.	Mill Diameter		Shank Diameter		Length of Cut	Overall Length
	UNCOATED	TiAlN based	e8	h6		
E9942010		GA942010	1.0	6	2.5	47
E9942020		GA942020	2.0	6	4	48
E9942030		GA942030	3.0	6	5	49
E9942040		GA942040	4.0	6	7	51
E9942050		GA942050	5.0	6	8	52
E9942060		GA942060	6.0	6	8	52
E9942070		GA942070	7.0	10	10	60
E9942080		GA942080	8.0	10	11	61
E9942090		GA942090	9.0	10	11	61
E9942100		GA942100	10.0	10	13	63
E9942120		GA942120	12.0	12	16	73
E9942140		GA942140	14.0	12	16	73
E9942160		GA942160	16.0	16	19	79
E9942180		GA942180	18.0	16	19	79
E9942200		GA942200	20.0	20	22	88
E9942220		GA942220	22.0	20	22	88
E9942250		GA942250	25.0	25	26	102

Tolerances according to DIN 7160 & 7161

Tolerance range in µm					
Nominal-Diameter in mm					
	from 1 to 3	over 3 to 6	over 6 to 10	over 10 to 18	over 18 to 30
e8	- 14 - 28	- 20 - 38	- 25 - 47	- 32 - 59	- 40 - 73
h6	0 - 6	0 - 8	0 - 9	0 - 11	0 - 13

◎ : Excellent ○ : Good

ISO Material Description	P										M					K									
	Non-alloy steel					Low alloy steel					High alloyed steel, and tool steel					Stainless steel					Grey cast iron		Nodular cast iron		Malleable cast iron
VDI 3323	1	2	3	4	5	6	7	8	9	10	11	12	13	14	15	16	17	18	19	20	3	25	130	230	
HRc	125	190	250	270	300	180	275	300	350	200	325	200	240	180	180	260	160	250	130	230	130	230	130	230	
Recommend	◎	◎	◎	◎	◎	◎	◎	◎	◎	◎	◎	◎	◎	◎	◎	◎	◎	◎	◎	◎	◎	◎	◎	◎	

ISO Material Description	N										S					H									
	Aluminum-wrought alloy		Aluminum-cast, alloyed			Copper and Copper Alloys (Bronze / Brass)			Non Metallic Materials		Heat Resistant Super Alloys					Titanium Alloys		Hardened steel		Chilled Cast Iron		Hardened Cast Iron			
VDI 3323	21	22	23	24	25	26	27	28	29	30	31	32	33	34	35	36	37	38	39	40	41	42	55	400	550
HRc	60	100	75	90	130	110	90	100			200	280	250	350	320	400 Rm	1050 Rm	550	630	400	550	400	550	400	550
Recommend						○	○	○																	

HSS-PM, 3 FLUTE SHORT LENGTH

- HSS-PM, 3 SCHNEIDEN KURZ
- FRAISES HSS-PM, 3 DENTS, SÉRIE COURTE
- 3 TAGLIENTI, SERIE CORTA, HSS-PM

- ▶ Designed to machine carbon steels, alloyed steels, stainless steels.
- ▶ Well balanced web design to minimize deflection and chattering.
- ▶ 3 flute design possess the advantage of 2 flute and 4 flute end mill.
- ▶ YG-1's new developed TANK-POWER Coating suitable for high speed cutting.

- ▶ Geeignet zum Fräsen von Stahl, legiertem Stahl und rostfreier Stahl.
- ▶ Verstärkter Kern zur Erhöhung der Stabilität.
- ▶ 3 Schneiden Design besitzt die Vorteile von 2-bzw 4 Schneiden Fräsem.
- ▶ Neuentwickelte Beschichtung für Hochgeschwindigkeitsfräsen.

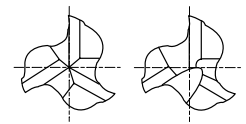

up to Ø1mm over Ø1mm

HSS PM
DIN 844
3
30°
DIN 1835B

p. 658 ~ 661

Unit : mm

EDP No.		Mill Diameter	Shank Diameter	Length of Cut	Overall Length
UNCOATED	TiAlN based	e8	h6		
E9A30010	GAA30010	1.0	6	3	47
E9A30020	GAA30020	2.0	6	7	51
E9A30030	GAA30030	3.0	6	8	52
E9A30040	GAA30040	4.0	6	11	55
E9A30050	GAA30050	5.0	6	13	57
E9A30060	GAA30060	6.0	6	13	57
E9A30070	GAA30070	7.0	10	16	66
E9A30080	GAA30080	8.0	10	19	69
E9A30090	GAA30090	9.0	10	19	69
E9A30100	GAA30100	10.0	10	22	72
E9A30120	GAA30120	12.0	12	26	83
E9A30140	GAA30140	14.0	12	26	83
E9A30160	GAA30160	16.0	16	32	92
E9A30180	GAA30180	18.0	16	32	92
E9A30200	GAA30200	20.0	20	38	104
E9A30220	GAA30220	22.0	20	38	104
E9A30250	GAA30250	25.0	25	45	121

Tolerances according to DIN 7160 & 7161

Tolerance range in µm					
Nominal-Diameter in mm					
	from 1 to 3	over 3 to 6	over 6 to 10	over 10 to 18	over 18 to 30
e8	- 14 - 28	- 20 - 38	- 25 - 47	- 32 - 59	- 40 - 73
h6	0 - 6	0 - 8	0 - 9	0 - 11	0 - 13

◎ : Excellent ○ : Good

ISO Material Description	P										M				K						
	Non-alloy steel					Low alloy steel					High alloyed steel, and tool steel				Stainless steel		Grey cast iron		Nodular cast iron		Malleable cast iron
VDI 3323	1	2	3	4	5	6	7	8	9	10	11	12	13	14	15	16	17	18	19	20	
HRC		13	25	28	32	10	29	32	38	15	35	15	23	10	10	26	3	25		21	
HB	125	190	250	270	300	180	275	300	350	200	325	200	240	180	180	260	160	250	130	230	
Recommend	◎	◎	◎	◎	◎	◎	◎	◎	○	◎	◎	◎	◎	◎	◎	◎	◎	◎	◎	◎	

ISO Material Description	N					S										H					
	Aluminum-wrought alloy		Aluminum-cast, alloyed			Copper and Copper Alloys (Bronze / Brass)			Non Metallic Materials		Heat Resistant Super Alloys					Titanium Alloys		Hardened steel	Chilled Cast Iron	Hardened Cast Iron	
VDI 3323	21	22	23	24	25	26	27	28	29	30	31	32	33	34	35	36	37	38	39	40	41
HRC											15	30	25	38	34			55	60	42	55
HB	60	100	75	90	130	110	90	100			200	280	250	350	320	400 Rm	1050 Rm	550	630	400	550
Recommend						○	○	○													

- CBN END MILLS
- i-Xmill END MILLS
- i-SMART MODULAR END MILLS
- X5070 END MILLS
- 4G MILL END MILLS
- X-POWER PRO END MILLS
- TitaNox-POWER END MILLS
- JET-POWER END MILLS
- V7 PLUS END MILLS
- ALU-POWER HPC END MILLS
- ALU-POWER END MILLS
- D-POWER GRAPHITE END MILLS
- D-POWER CFRP END MILLS
- ROUTERS
- CRX S END MILLS
- K-2 END MILLS
- ONLY ONE COATED PM60 END MILLS
- TANK-POWER END MILLS
- GENERAL HSS END MILLS
- MILLING CUTTERS
- TECHNICAL DATA



UNCOATED **E9938** SERIES
TiAlN based COATED **GA938** SERIES

HSS-PM, 4 FLUTE SHORT LENGTH

- HSS-PM, 4 SCHNEIDEN KURZ
- FRAISES HSS-PM, 4 DENTS, SÉRIE COURTE
- 4 TAGLIENTI, SERIE CORTA, HSS-PM

- ▶ Designed to machine carbon steels, alloyed steels, stainless steels.
- ▶ Recommended for pocketing, cam milling, die sinking and slotting..
- ▶ Designed for high speed cutting of difficult-to-cut materials.
- ▶ YG-1's new developed TANK-POWER Coating suitable for high speed cutting.
- ▶ Geeignet zum Fräsen von Stahl, legiertem Stahl und rostfreier Stahl.
- ▶ Empfohlen für Taschenfräsen, Nockenfräsen, Gussformen und Nutenfräsen.
- ▶ Geeignet für Hochgeschwindigkeitsfräsen von schwer zu zerspanenden Materialien.
- ▶ Neuentwickelte Beschichtung für Hochgeschwindigkeitsfräsen.

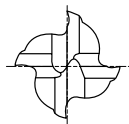

HSS PM
DIN 844
4
30°
DIN 1835B
P.662~663

Unit : mm

EDP No.	Mill Diameter	Shank Diameter	Length of Cut	Overall Length
E9938010	1.0	6	3	49
E9938020	2.0	6	7	51
E9938030	3.0	6	8	52
E9938040	4.0	6	11	55
E9938050	5.0	6	13	57
E9938060	6.0	6	13	57
E9938070	7.0	10	16	66
E9938080	8.0	10	19	69
E9938090	9.0	10	19	69
E9938100	10.0	10	22	72
E9938120	12.0	12	26	83
E9938140	14.0	12	26	83
E9938160	16.0	16	32	92
E9938180	18.0	16	32	92
E9938200	20.0	20	38	104
E9938220	22.0	20	38	104
E9938250	25.0	25	45	121

▶ Mill Diameter 1mm: Center match end teeth

Mill Dia. Tolerance (mm)	Shank Dia. Tolerance
0 ~ -0.03	h6

◎ : Excellent ○ : Good

ISO Material Description	P											M			K					
	Non-alloy steel					Low alloy steel				High alloyed steel, and tool steel		Stainless steel			Grey cast iron		Nodular cast iron		Malleable cast iron	
VDI 3323	1	2	3	4	5	6	7	8	9	10	11	12	13	14	15	16	17	18	19	20
HRc		13	25	28	32	10	29	32	38	15	35	15	23	10	10	26	3	25		21
HB	125	190	250	270	300	180	275	300	350	200	325	200	240	180	180	260	160	250	130	230
Recommend	◎	◎	◎	◎	◎	◎	◎	◎	◎	◎	◎	◎	◎	◎	◎	◎	◎	◎	◎	◎

ISO Material Description	N										S					H					
	Aluminum-wrought alloy		Aluminum-cast, alloyed			Copper and Copper Alloys (Bronze / Brass)		Non Metallic Materials			Heat Resistant Super Alloys					Titanium Alloys		Hardened steel	Chilled Cast Iron	Hardened Cast Iron	
VDI 3323	21	22	23	24	25	26	27	28	29	30	31	32	33	34	35	36	37	38	39	40	41
HRc											15	30	25	38	34			55	60	42	55
HB	60	100	75	90	130	110	90	100			200	280	250	350	320	400 Rm	1050 Rm	550	630	400	550
Recommend						○	○	○													

HSS-PM, 4 FLUTE LONG LENGTH

- HSS-PM, 4 SCHNEIDEN LANG
- FRAISES HSS-PM, 4 DENTS, SÉRIE LONGUE
- 4 TAGLIENTI, SERIE LUNGA, HSS-PM

- ▶ Designed to machine carbon steels, alloyed steels, stainless steels.
- ▶ Recommended for pocketing, cam milling, die sinking and slotting.
- ▶ Designed for high speed cutting of difficult-to-cut materials.
- ▶ YG-1's new developed TANK-POWER Coating suitable for high speed cutting.

- ▶ Geeignet zum Fräsen von Stahl, legiertem Stahl und rostfreier Stahl.
- ▶ Empfohlen für Taschenfräsen, Nockenfräsen, Gussformen und Nutenfräsen.
- ▶ Geeignet für Hochgeschwindigkeitsfräsen von schwer zu zerspanenden Materialien.
- ▶ Neuentwickelte Beschichtung für Hochgeschwindigkeitsfräsen.

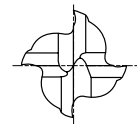

HSS PM
DIN 844
4
30°
DIN 1835B
P.662-663

Unit : mm

EDP No.		Mill Diameter	Shank Diameter	Length of Cut	Overall Length
UNCOATED	TiAlN based				
E9A31020	GAA31020	2.0	6	10	54
E9A31030	GAA31030	3.0	6	12	56
E9A31040	GAA31040	4.0	6	19	63
E9A31050	GAA31050	5.0	6	24	68
E9A31060	GAA31060	6.0	6	24	68
E9A31070	GAA31070	7.0	10	30	80
E9A31080	GAA31080	8.0	10	38	88
E9A31090	GAA31090	9.0	10	38	88
E9A31100	GAA31100	10.0	10	45	95
E9A31120	GAA31120	12.0	12	53	110
E9A31140	GAA31140	14.0	12	53	110
E9A31160	GAA31160	16.0	16	63	123
E9A31180	GAA31180	18.0	16	63	123
E9A31200	GAA31200	20.0	20	75	141
E9A31220	GAA31220	22.0	20	75	141
E9A31250	GAA31250	25.0	25	90	166

Mill Dia. Tolerance (mm)	Shank Dia. Tolerance
0 ~ -0.03	h6

◎ : Excellent ○ : Good

ISO Material Description	P										M			K							
	Non-alloy steel					Low alloy steel					High alloyed steel, and tool steel			Stainless steel			Grey cast iron		Nodular cast iron		Malleable cast iron
VDI 3323	1	2	3	4	5	6	7	8	9	10	11	12	13	14	15	16	17	18	19	20	
HRc																					
HB	125	130	250	270	300	180	275	300	350	200	325	200	240	180	180	260	160	250	130	230	
Recommend	◎	◎	◎	◎	◎	◎	◎	◎	○	◎	◎	◎	◎	◎	◎	◎	◎	◎	◎	◎	

ISO Material Description	N					S										H					
	Aluminum-wrought alloy		Aluminum-cast, alloyed			Copper and Copper Alloys (Bronze / Brass)			Non Metallic Materials		Heat Resistant Super Alloys					Titanium Alloys		Hardened steel	Chilled Cast Iron	Hardened Cast Iron	
VDI 3323	21	22	23	24	25	26	27	28	29	30	31	32	33	34	35	36	37	38	39	40	41
HRc																					
HB	60	100	75	90	130	110	90	100			200	280	250	350	320	400 Rm	1050 Rm	550	630	400	550
Recommend						○	○	○													



UNCOATED

E9941 SERIES

TiAlN based COATED

GA941 SERIES

HSS-PM, MULTI FLUTE SHORT LENGTH ROUGHING - FINE

- HSS-PM, MULTI SCHNEIDEN KURZ SCHRUPPFRÄSER - FEIN
- FRAISES HSS-PM, MULTI-DENTS RAVAGEUSE - PAS FINS, SÉRIE COURTE
- MULTI TAGL., PER SGROSSATURA, SERIE CORTA, BOMBATO FINE - HSS PM

- ▶ Suitable for high-feed roughing milling.
- ▶ Designed to machine carbon steels, alloyed steels, stainless steels.
- ▶ Providing excellent finished surfaces in many cases.
- ▶ YG-1's new developed TANK-POWER Coating suitable for high speed cutting.
- ▶ up to $\varnothing 20$: center cut, over $\varnothing 20$: non center cut

- ▶ Geeignet zum HSC - Schrupp - Fräsen.
- ▶ Geeignet zum Fräsen von Stahl, legiertem Stahl und rostfreier Stahl.
- ▶ Liefert in vielen Fällen exzellente bearbeitete Oberflächen.
- ▶ Neuentwickelte Beschichtung für Hochgeschwindigkeitsfräsen.
- ▶ Bis D=20mm : Mit Zentrumschneide, über D=20mm : Ohne Zentrumschneide.

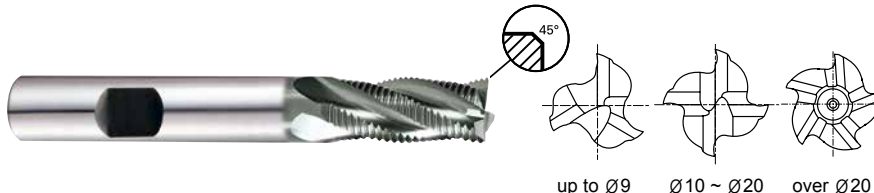

HSS PM
DIN 844
HR
3-5
30°
DIN 1835B
~Ø20
Ø22~
C x 45°
P.664~665

EDP No.		Mill Diameter	Shank Diameter	Length of Cut	Overall Length	No. of Flute	Chamfer
UNCOATED	X-COATING	js12	h6				
E9941060	GA941060	6.0	6	13	57	3	0.18
E9941070	GA941070	7.0	10	16	66	3	0.18
E9941080	GA941080	8.0	10	19	69	3	0.18
E9941090	GA941090	9.0	10	19	69	3	0.18
E9941100	GA941100	10.0	10	22	72	4	0.18
E9941120	GA941120	12.0	12	26	83	4	0.18
E9941140	GA941140	14.0	12	26	83	4	0.25
E9941160	GA941160	16.0	16	32	92	4	0.25
E9941180	GA941180	18.0	16	32	92	4	0.25
E9941200	GA941200	20.0	20	38	104	4	0.25
E9941220	GA941220	22.0	20	38	104	5	0.36
E9941250	GA941250	25.0	25	45	121	5	0.36

Unit : mm

Tolerances according to DIN 7160 & 7161

		Tolerance range in μm					
		Nominal-Diameter in mm					
		from 1 to 3	over 3 to 6	over 6 to 10	over 10 to 18	over 18 to 30	over 30 to 50
js12		± 50	± 60	± 75	± 90	± 105	± 125
h6		0 -6	0 -8	0 -9	0 -11	0 -13	0 -16

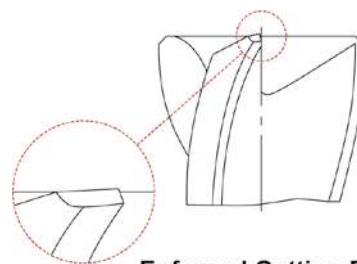

Enforced Cutting Edge

◎ : Excellent ○ : Good

ISO	P											M				K					
	Non-alloy steel					Low alloy steel				High alloyed steel, and tool steel		Stainless steel		Grey cast iron		Nodular cast iron		Malleable cast iron			
Material Description	1	2	3	4	5	6	7	8	9	10	11	12	13	14	15	16	17	18	19	20	
VDI 3323																					
HRc	13	25	28	32	10	29	32	38	15	35	15	23	10	10	26	3	25		21		
HB	125	190	250	270	300	180	275	300	350	200	325	200	240	180	180	260	160	250	130	230	
Recommend	◎	◎	◎	◎	◎	◎	◎	◎	○	◎	○	◎	◎	◎	◎	◎	◎	◎	◎	◎	
ISO	N									S							H				
	Aluminum-wrought alloy		Aluminum-cast, alloyed			Copper and Copper Alloys (Bronze / Brass)		Non Metallic Materials		Heat Resistant Super Alloys					Titanium Alloys		Hardened steel	Chilled Cast Iron	Hardened Cast Iron		
Material Description	21	22	23	24	25	26	27	28	29	30	31	32	33	34	35	36	37	38	39	40	41
VDI 3323																					
HRc	60	100	75	90	130	110	90	100			15	30	25	38	34			55	60	42	55
HB											200	280	250	350	320	400 Rm	1050 Rm	550	630	400	550
Recommend						○	○	○													

HSS-PM, MULTI FLUTE LONG LENGTH ROUGHING - FINE

- HSS-PM, MULTI SCHNEIDEN LANG SCHRUPFRÄSER - FEIN
- FRAISES HSS-PM, MULTI-DENTS RAVAGEUSE - PAS FINS, SÉRIE LONGUE
- MULTI TAGL., PER SGROSSATURA, SERIE LUNGA, BOMBATO FINE - HSS PM

- ▶ Suitable for high-feed roughing milling.
- ▶ Designed to machine carbon steels, alloyed steels, stainless steels..
- ▶ Providing excellent finished surfaces in many cases.
- ▶ YG-1's new developed TANK-POWER Coating suitable for high speed cutting.
- ▶ up to Ø20 : center cut, over Ø20 : non center cut

- ▶ Geeignet zum HSC - Schrump - Fräsen.
- ▶ Geeignet zum Fräsen von Stahl, legiertem Stahl und rostfreier Stahl.
- ▶ Liefert in vielen Fällen exzellente bearbeitete Oberflächen.
- ▶ Neuentwickelte Beschichtung für Hochgeschwindigkeitsfräsen.
- ▶ Bis D=20mm : Mit Zentrumschneide, über D=20mm : Ohne Zentrumschneide.

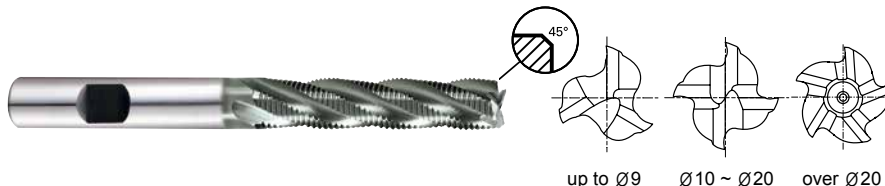

HSS PM
DIN 844
HR
3-5
30°
DIN 1835B
~Ø20
Ø22~
C x 45°
P.664~665

Unit : mm

EDP No.		Mill Diameter	Shank Diameter	Length of Cut	Overall Length	No. of Flute	Chamfer
UNCOATED	X-COATING	js12	h6				
E9A35060	GAA35060	6.0	6	24	68	3	0.18
E9A35070	GAA35070	7.0	10	30	80	3	0.18
E9A35080	GAA35080	8.0	10	38	88	3	0.18
E9A35090	GAA35090	9.0	10	38	88	3	0.18
E9A35100	GAA35100	10.0	10	45	95	4	0.18
E9A35120	GAA35120	12.0	12	53	110	4	0.18
E9A35140	GAA35140	14.0	12	53	110	4	0.25
E9A35160	GAA35160	16.0	16	63	123	4	0.25
E9A35180	GAA35180	18.0	16	63	123	4	0.25
E9A35200	GAA35200	20.0	20	75	141	4	0.25
E9A35220	GAA35220	22.0	20	75	141	5	0.36
E9A35250	GAA35250	25.0	25	90	166	5	0.36

Tolerances according to DIN 7160 & 7161

	Tolerance range in μm					
	Nominal-Diameter in mm					
	from 1 to 3	over 3 to 6	over 6 to 10	over 10 to 18	over 18 to 30	over 30 to 50
js12	± 50	± 60	± 75	± 90	± 105	± 125
h6	0 - 6	0 - 8	0 - 9	0 - 11	0 - 13	0 - 16

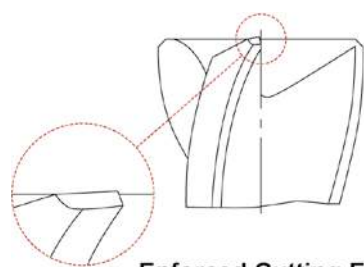

Enforced Cutting Edge

◎ : Excellent ○ : Good

ISO	P										M				K						
	Non-alloy steel					Low alloy steel					High alloyed steel, and tool steel				Stainless steel		Grey cast iron		Nodular cast iron		Malleable cast iron
Material Description	1	2	3	4	5	6	7	8	9	10	11	12	13	14	15	16	17	18	19	20	
VDI 3323	1	2	3	4	5	6	7	8	9	10	11	12	13	14	15	16	17	18	19	20	
HRC	13	13	25	28	32	10	29	32	38	15	35	15	23	10	10	26	3	25			
HB	125	190	250	270	300	180	275	300	350	200	325	200	240	180	180	260	160	250	130	230	
Recommend	◎	◎	◎	◎	◎	◎	◎	◎	◎	◎	◎	◎	◎	◎	◎	◎	◎	◎	◎	◎	

ISO	N					S					H										
	Aluminum-wrought alloy		Aluminum-cast, alloyed		Copper and Copper Alloys (Bronze / Brass)	Non Metallic Materials	Heat Resistant Super Alloys			Titanium Alloys		Hardened steel	Chilled Cast Iron	Hardened Cast Iron							
Material Description	21	22	23	24	25	26	27	28	29	30	31	32	33	34	35	36	37	38	39	40	41
VDI 3323	21	22	23	24	25	26	27	28	29	30	31	32	33	34	35	36	37	38	39	40	41
HRC	60	100	75	90	130	110	90	100			15	30	25	38	34	55	60	55	60	42	55
HB	60	100	75	90	130	110	90	100			200	280	250	350	320	400 Rm	1050 Rm	550	630	400	550
Recommend						○	○	○													



TANK-POWER
HSS-PM END MILLS

UNCOATED

E9A26 SERIES

TiAlN based COATED

GAA26 SERIES

HSS-PM, MULTI FLUTE 45°HELIX SHORT LENGTH ROUGHING - FINE

- HSS-PM, MULTI SCHNEIDEN 45°RECHTSSPIRALE KURZ SCHRUPFRÄSER - FEIN
- FRAISES HSS-PM, MULTI-DENTS RAVAGEUSE HÉLICE À 45° - PAS FINS, SÉRIE COURTE
- MULTI TAGL., ELICA 45°, PER SGROS., SERIE CORTA, BOMBATO FINE - HSS PM

- ▶ High chip removal and minimizing breakages of cutting edges.
- ▶ Designed to machine carbon steels, alloyed steels, stainless steels
- ▶ YG-1's new developed TANK-POWER Coating suitable for high speed cutting

- ▶ Schnelle Spanabfuhr und Minimierung von Schneidkantenausbrüchen
- ▶ Geeignet zum Fräsen von Stahl, legiertem Stahl und rostfreier Stahl.
- ▶ Neuentwickelte Beschichtung für Hochgeschwindigkeitsfräsen.

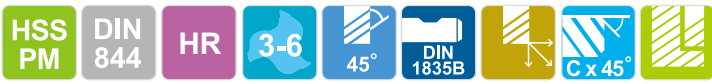
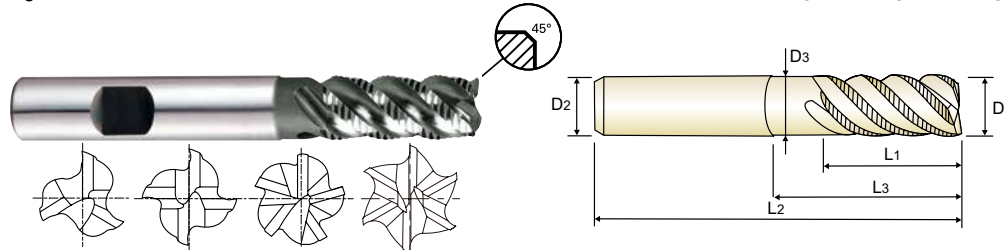

P.666-667

Unit : mm

EDP No.		Mill Diameter	Shank Diameter	Length of Cut	Length Below Shank	Overall Length	Neck Diameter	No. of Flute	Chamfer
UNCOATED	X-COATING	D1(js12)	D2(h6)	L1	L3	L2	D3		
E9A26040	GAA26040	4.0	6	11	-	57	-	3	0.1
E9A26050	GAA26050	5.0	6	13	-	57	-	4	0.13
E9A26060	GAA26060	6.0	6	13	-	57	-	4	0.15
E9A26070	GAA26070	7.0	10	16	-	66	-	4	0.15
E9A26080	GAA26080	8.0	10	19	-	69	-	4	0.18
E9A26090	GAA26090	9.0	10	19	-	69	-	4	0.18
E9A26100	GAA26100	10.0	10	22	31	72	9.5	4	0.20
E9A26120	GAA26120	12.0	12	26	37	83	11.5	4	0.20
E9A26140	GAA26140	14.0	12	26	-	83	-	5	0.20
E9A26160	GAA26160	16.0	16	32	44	92	15	5	0.20
E9A26180	GAA26180	18.0	16	32	-	92	-	6	0.20
E9A26200	GAA26200	20.0	20	38	54	104	19	6	0.20
E9A26250	GAA26250	25.0	25	45	63	121	24	6	0.20

Tolerances according to DIN 7160 & 7161

	Tolerance range in μm					
	Nominal-Diameter in mm					
	from 1 to 3	over 3 to 6	over 6 to 10	over 10 to 18	over 18 to 30	over 30 to 50
js12	± 50	± 60	± 75	± 90	± 105	± 125
h6	0 -6	0 -8	0 -9	0 -11	0 -13	0 -16

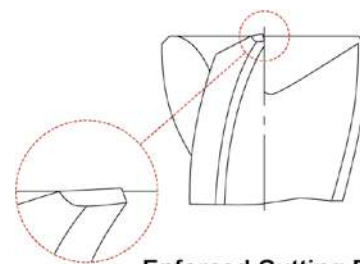

Enforced Cutting Edge

◎ : Excellent ○ : Good

ISO Material Description	P										M				K								
	Non-alloy steel					Low alloy steel					High alloyed steel, and tool steel				Stainless steel				Grey cast iron		Nodular cast iron		Malleable cast iron
VDI 3323	1	2	3	4	5	6	7	8	9	10	11	12	13	14	15	16	17	18	19	20			
HRc		13	25	28	32	10	29	32	38	15	35	15	23	10	10	26	3	25		21			
HB	125	190	250	270	300	180	275	300	350	200	325	200	240	180	180	260	160	250	130	230			
Recommend	◎	◎	◎	◎	◎	◎	◎	◎	◎	◎	◎	◎	◎	◎	◎	◎	◎	◎	◎	◎			
ISO Material Description	N										S						H						
	Aluminum-wrought alloy		Aluminum-cast, alloyed			Copper and Copper Alloys (Bronze / Brass)			Non Metallic Materials		Heat Resistant Super Alloys						Titanium Alloys		Hardened steel		Chilled Cast Iron		Hardened Cast Iron
VDI 3323	21	22	23	24	25	26	27	28	29	30	31	32	33	34	35	36	37	38	39	40	41		
HRc											15	30	25	38	34			55	60	42	55		
HB	60	100	75	90	130	110	90	100			200	280	250	350	320	400 Rm	1050 Rm	550	630	400	550		
Recommend						○	○	○															

HSS-PM, MULTI FLUTE SHORT LENGTH ROUGHING - COARSE

- HSS-PM, MULTI SCHNEIDEN KURZ SCHRUPFRÄSER - GROB
- FRAISES HSS-PM, MULTI-DENTS RAVAGEUSE - PAS GROSSIERS, SÉRIE COURTE
- MULTI TAGL., PER SGROS., SERIE CORTA, BOMBATO GROSSO - HSS PM

- ▶ Suitable for high-feed roughing milling.
- ▶ Designed to machine carbon steels, alloyed steels, stainless steels.
- ▶ YG-1's new developed TANK-POWER Coating suitable for high speed cutting.
- ▶ up to $\varnothing 20$: center cut, over $\varnothing 20$: non center cut
- ▶ Geeignet zum HSC - Schrump - Fräsen.
- ▶ Geeignet zum Fräsen von Stahl, legiertem Stahl und rostfreier Stahl.
- ▶ Neuentwickelte Beschichtung für Hochgeschwindigkeitsfräsen.
- ▶ Bis $D \leq 20\text{mm}$: mit Zentrumschnitt, über $D \leq 20\text{mm}$: Ohne Zentrumschnitt.

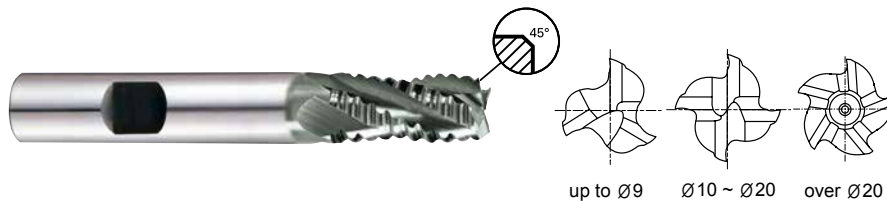

HSS PM
DIN 844
NR
3-5
30°
DIN 1835B
 $\sim \varnothing 20$
 $\varnothing 22$
C x 45°
P.664~665

Unit : mm

EDP No.		Mill Diameter	Shank Diameter	Length of Cut	Overall Length	No. of Flute	Chamfer
UNCOATED	X-COATING	js12	h6				
E9A33060	GAA33060	6.0	6	13	57	3	0.25
E9A33070	GAA33070	7.0	10	16	66	3	0.25
E9A33080	GAA33080	8.0	10	19	69	3	0.25
E9A33090	GAA33090	9.0	10	19	69	3	0.36
E9A33100	GAA33100	10.0	10	22	72	4	0.36
E9A33120	GAA33120	12.0	12	26	83	4	0.5
E9A33140	GAA33140	14.0	12	26	83	4	0.55
E9A33160	GAA33160	16.0	16	32	92	4	0.55
E9A33180	GAA33180	18.0	16	32	92	4	0.55
E9A33200	GAA33200	20.0	20	38	104	4	0.55
E9A33220	GAA33220	22.0	20	38	104	5	0.55
E9A33250	GAA33250	25.0	25	45	121	5	0.55

Tolerances according to DIN 7160 & 7161

	Tolerance range in μm					
	Nominal-Diameter in mm					
	from 1 to 3	over 3 to 6	over 6 to 10	over 10 to 18	over 18 to 30	over 30 to 50
js12	± 50	± 60	± 75	± 90	± 105	± 125
h6	0 -6	0 -8	0 -9	0 -11	0 -13	0 -16

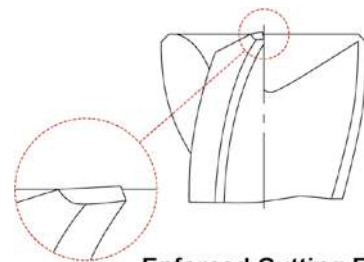

Enforced Cutting Edge

◎ : Excellent ○ : Good

ISO Material Description	P										M				K						
	Non-alloy steel					Low alloy steel					High alloyed steel, and tool steel				Stainless steel		Grey cast iron		Nodular cast iron		Malleable cast iron
VDI 3323	1	2	3	4	5	6	7	8	9	10	11	12	13	14	15	16	17	18	19	20	
HRc	13	25	28	32	10	29	32	38	15	35	15	23	10	10	26	3	25		21		
HB	125	190	250	270	300	180	275	300	350	200	325	200	240	180	180	260	160	250	130	230	
Recommend	◎	◎	◎	◎	◎	◎	◎	◎	○	◎	◎	◎	◎	◎	◎	◎	◎	◎	◎		
ISO Material Description	N									S						H					
	Aluminum-wrought alloy		Aluminum-cast, alloyed			Copper and Copper Alloys (Bronze / Brass)		Non Metallic Materials		Heat Resistant Super Alloys						Titanium Alloys		Hardened steel	Chilled Cast Iron	Hardened Cast Iron	
VDI 3323	21	22	23	24	25	26	27	28	29	30	31	32	33	34	35	36	37	38	39	40	41
HRc											15	30	25	38	34			55	60	42	55
HB	60	100	75	90	130	110	90	100			200	280	250	350	320	400 Rm	1050 Rm	550	630	400	550
Recommend						○	○	○													



UNCOATED

E9A34 SERIES

TiAlN based COATED

GAA34 SERIES

HSS-PM, MULTI FLUTE LONG LENGTH ROUGHING - COARSE

- **HSS-PM, MULTI SCHNEIDEN LANG SCHRUPFRÄSER - GROB**
- **FRAISES HSS-PM, MULTI-DENTS RAVAGEUSE - PAS GROSSIERS, SÉRIE LONGUE**
- **MULTI TAGL., PER SGROSSATURA, SERIE LUNGA, BOMBATO GROSSO - HSS PM**

- ▶ Suitable for high-feed roughing milling.
- ▶ Designed to machine carbon steels, alloyed steels, stainless steels.
- ▶ YG-1's new developed TANK-POWER Coating suitable for high speed cutting.
- ▶ up to $\varnothing 20$: center cut, over $\varnothing 20$: non center cut

- ▶ Geeignet zum HSC - Schrupp - Fräsen.
- ▶ Geeignet zum Fräsen von Stahl, legiertem Stahl und rostfreier Stahl.
- ▶ Neuentwickelte Beschichtung für Hochgeschwindigkeitsfräsen.
- ▶ Bis $D \leq 20\text{mm}$: mit Zentrumschnitt, über $D > 20\text{mm}$: Ohne Zentrumschnitt.



HSS PM
DIN 844
NR
3-5
30°
DIN 1835B
~Ø20
Ø22~
C x 45°
P.664~665

Unit : mm

EDP No.		Mill Diameter	Shank Diameter	Length of Cut	Overall Length	No. of Flute	Chamfer
UNCOATED	X-COATING	js12	h6				
E9A34060	GAA34060	6.0	6	24	68	3	0.25
E9A34070	GAA34070	7.0	10	30	80	3	0.25
E9A34080	GAA34080	8.0	10	38	88	3	0.25
E9A34090	GAA34090	9.0	10	38	88	3	0.36
E9A34100	GAA34100	10.0	10	45	95	4	0.36
E9A34120	GAA34120	12.0	12	53	110	4	0.5
E9A34140	GAA34140	14.0	12	53	110	4	0.55
E9A34160	GAA34160	16.0	16	63	123	4	0.55
E9A34180	GAA34180	18.0	16	63	123	4	0.55
E9A34200	GAA34200	20.0	20	75	141	4	0.55
E9A34220	GAA34220	22.0	20	75	141	5	0.55
E9A34250	GAA34250	25.0	25	90	166	5	0.55

Tolerances according to DIN 7160 & 7161

Tolerance range in μm						
Nominal-Diameter in mm						
	from 1 to 3	over 3 to 6	over 6 to 10	over 10 to 18	over 18 to 30	over 30 to 50
js12	± 50	± 60	± 75	± 90	± 105	± 125
h6	0 -6	0 -8	0 -9	0 -11	0 -13	0 -16

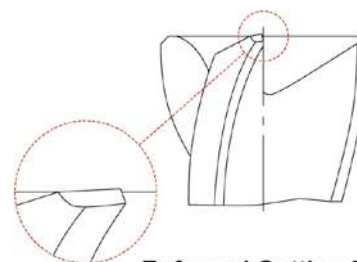

Enforced Cutting Edge

◎ : Excellent ○ : Good

ISO	P										M				K						
	Non-alloy steel					Low alloy steel					High alloyed steel, and tool steel				Stainless steel		Grey cast iron		Nodular cast iron		Malleable cast iron
Material Description	1	2	3	4	5	6	7	8	9	10	11	12	13	14	15	16	17	18	19	20	
VDI 3323	1	2	3	4	5	6	7	8	9	10	11	12	13	14	15	16	17	18	19	20	
HRc	13	25	28	32	10	29	32	38	15	35	15	23	10	10	26	3	25	21	21		
HB	125	190	250	270	300	180	275	300	350	200	325	200	240	180	180	260	160	250	130	230	
Recommend	◎	◎	◎	◎	◎	◎	◎	◎	◎	◎	◎	◎	◎	◎	◎	◎	◎	◎	◎	◎	
ISO	N										S							H			
	Aluminum-wrought alloy		Aluminum-cast, alloyed			Copper and Copper Alloys (Bronze / Brass)			Non Metallic Materials		Heat Resistant Super Alloys					Titanium Alloys		Hardened steel	Chilled Cast Iron	Hardened Cast Iron	
Material Description	21	22	23	24	25	26	27	28	29	30	31	32	33	34	35	36	37	38	39	40	41
VDI 3323	21	22	23	24	25	26	27	28	29	30	31	32	33	34	35	36	37	38	39	40	41
HRc	60	100	75	90	130	110	90	100			15	30	25	38	34			55	60	42	55
HB	60	100	75	90	130	110	90	100			200	280	250	350	320	400 Rm	1050 Rm	550	630	400	550
Recommend						○	○	○													

HSS-PM, 4&5 FLUTE ROUGHING WITH NECK - COARSE

- HSS-PM, 4&5 SCHNEIDEN SCHRUPFRÄSER mit ABGESETZTEM SCHAFTTETL - GROB
- FRAISES HSS-PM, 4&5-DENTS RAVAGEUSE AVEC DÉGAGEMENT - PAS GROSSIERS
- 4&5 TAGL., PER SGROSSATURA, SCARICATA - HSS PM

- ▶ High chip removal and minimizing breakages of cutting edges.
- ▶ Design to machine carbon steels, alloyed steels, stainless steels.
- ▶ YG-1's new developed TANK-POWER Coating suitable for high speed cutting.
- ▶ Schnelle Spanabfuhr und Minimierung von Schneidkantenausbrüchen
- ▶ Geeignet zum Fräsen von Stahl, legiertem Stahl und rostfreier Stahl.
- ▶ Neuentwickelte Beschichtung für Hochgeschwindigkeitsfräsen.

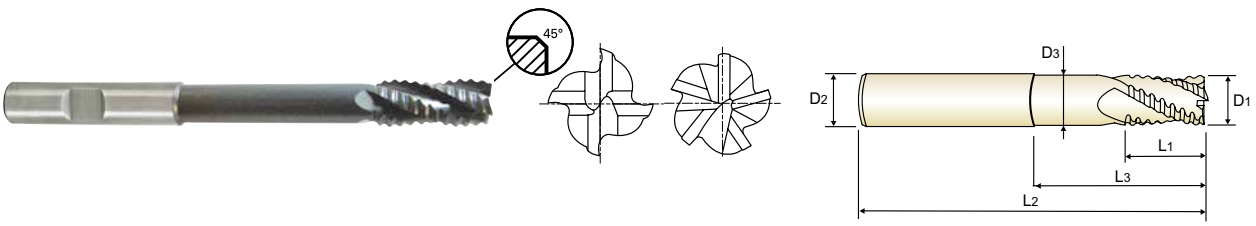

Unit : mm

EDP No.		Mill Diameter	Shank Diameter	Length of Cut	Length Below Shank	Overall Length	Neck Diameter	No. of Flute	Chamfer
UNCOATED	X-COATING	D1(js12)	D2(h6)	L1	L3	L2	D3		
E9E43100	GAE43100	10.0	10	22	69	110	8.5	4	0.34
E9E43120	GAE43120	12.0	12	26	78	125	10.5	4	0.50
E9E43160	GAE43160	16.0	16	32	87	138	14	4	0.55
E9E43200	GAE43200	20.0	20	38	108	160	18	5	0.55
E9E43250	GAE43250	25.0	25	45	155	216	23	5	0.55

Tolerances according to DIN 7160 & 7161

Tolerance range in μm						
Nominal-Diameter in mm						
	from 1 to 3	over 3 to 6	over 6 to 10	over 10 to 18	over 18 to 30	over 30 to 50
js12	± 50	± 60	± 75	± 90	± 105	± 125
h6	0 - 6	0 - 8	0 - 9	0 - 11	0 - 13	0 - 16

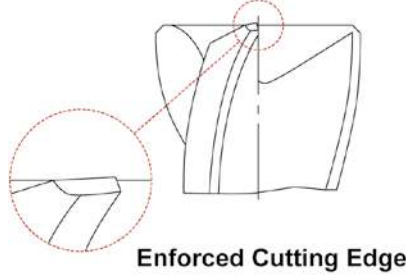

◎ : Excellent ○ : Good

ISO Material Description	P										M				K								
	Non-alloy steel					Low alloy steel					High alloyed steel, and tool steel				Stainless steel				Grey cast iron		Nodular cast iron		Malleable cast iron
VDI 3323	1	2	3	4	5	6	7	8	9	10	11	12	13	14	15	16	17	18	19	20			
HRc	13	25	28	32	10	29	32	38	10	35	15	23	10	10	26	3	25	3	21				
HB	125	190	250	270	300	180	275	300	350	200	325	200	240	180	180	260	160	250	130	230			
Recommend	◎	◎	◎	◎	◎	◎	◎	◎	○	◎	◎	◎	◎	◎	◎	◎	◎	◎	◎	◎			
ISO Material Description	N									S						H							
	Aluminum-wrought alloy		Aluminum-cast, alloyed			Copper and Copper Alloys (Bronze / Brass)		Non Metallic Materials		Heat Resistant Super Alloys						Titanium Alloys		Hardened steel	Chilled Cast Iron	Hardened Cast Iron			
VDI 3323	21	22	23	24	25	26	27	28	29	30	31	32	33	34	35	36	37	38	39	40	41		
HRc	60	100	75	90	130	110	90	100			15	30	25	38	34	200	280	55	60	42	55		
HB	60	100	75	90	130	110	90	100			200	280	250	350	320	400 Rm	1050 Rm	550	630	400	550		
Recommend						○	○	○															

- CBN END MILLS
- i-Xmill END MILLS
- i-SMART MODULAR END MILLS
- X5070 END MILLS
- 4G MILL END MILLS
- X-POWER PRO END MILLS
- TitaNox-POWER END MILLS
- JET-POWER END MILLS
- V7 PLUS END MILLS
- ALU-POWER HPC END MILLS
- ALU-POWER END MILLS
- D-POWER GRAPHITE END MILLS
- D-POWER CFRP END MILLS
- ROUTERS
- CRX S END MILLS
- K-2 END MILLS
- ONLY ONE COATED PM60 END MILLS
- TANK-POWER END MILLS
- GENERAL HSS END MILLS
- MILLING CUTTERS
- TECHNICAL DATA



RECOMMENDED CUTTING CONDITIONS
EMPFOHLENE SCHNEIDPARAMETER

GA940 , GAA32 SERIES **2 FLUTE BALL NOSE**

Vc = m/min.
fz = mm/tooth
RPM = rev./min.
FEED = mm/min.

ISO	VDI 3323	Material Description	Ae	Ap	Parameter	Diameter (Ø)									
						3.0	4.0	6.0	8.0	10.0	12.0	16.0	20.0	25.0	
P	1	Non-alloy steel	0.5D	0.2D	Vc	70	75	85	85	85	85	85	85	85	75
					fz	0.023	0.036	0.055	0.079	0.109	0.115	0.141	0.156	0.163	
					RPM	7427	5968	4509	3382	2706	2255	1691	1353	955	
					FEED	342	430	496	534	590	519	477	422	311	
	2		Vc	55	60	65	65	65	70	65	65	60			
			fz	0.02	0.031	0.046	0.067	0.095	0.097	0.123	0.14	0.142			
			RPM	5836	4775	3448	2586	2069	1857	1293	1035	764			
	3-4		Vc	35	40	45	45	45	45	45	45	35			
			fz	0.016	0.027	0.039	0.056	0.082	0.083	0.101	0.11	0.122			
	5		Vc	20	20	25	20	20	20	20	25	20			
fz		0.014	0.023	0.035	0.048	0.075	0.073	0.091	0.097	0.104					
RPM		2122	1592	1326	796	637	531	398	398	255					
6	Vc	55	60	65	65	65	70	65	65	60					
	fz	0.02	0.031	0.046	0.067	0.095	0.097	0.123	0.14	0.142					
	RPM	5836	4775	3448	2586	2069	1857	1293	1035	764					
7	Vc	35	40	45	45	45	45	45	45	35					
	fz	0.016	0.027	0.039	0.056	0.082	0.083	0.101	0.11	0.122					
	RPM	3714	3183	2387	1790	1432	1194	895	716	446					
8-9	Vc	20	20	25	20	20	20	20	25	20					
	fz	0.014	0.023	0.035	0.048	0.075	0.073	0.091	0.097	0.104					
	RPM	2122	1592	1326	796	637	531	398	398	255					
10	Vc	55	60	65	65	65	70	65	65	60					
	fz	0.02	0.031	0.046	0.067	0.095	0.097	0.123	0.14	0.142					
	RPM	5836	4775	3448	2586	2069	1857	1293	1035	764					
11.1	Vc	20	20	25	20	20	20	20	25	20					
	fz	0.014	0.023	0.035	0.048	0.075	0.073	0.091	0.097	0.104					
	RPM	2122	1592	1326	796	637	531	398	398	255					
M	14.1	Stainless steel	0.5D	0.2D	Vc	20	20	25	25	25	25	25	25	20	
					fz	0.014	0.023	0.036	0.048	0.073	0.074	0.092	0.1	0.1	
					RPM	2122	1592	1326	995	796	663	497	398	255	
K	15-20	Grey cast iron Nodular cast iron Malleable cast iron	0.5D	0.2D	Vc	55	60	65	65	65	70	65	65	60	
					fz	0.02	0.031	0.046	0.067	0.095	0.097	0.123	0.14	0.142	
					RPM	5836	4775	3448	2586	2069	1857	1293	1035	764	
FEED						233	296	317	347	393	360	318	290	217	

※ The FEED, in long & extra long types, should be reduced by around 50%

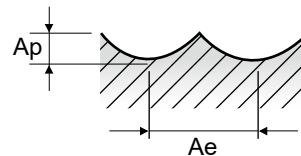

E9940 , E9A32 SERIES 2 FLUTE BALL NOSE

Vc = m/min.
fz = mm/tooth
RPM = rev./min.
FEED = mm/min.

ISO	VDI 3323	Material Description	Ae	Ap	Parameter	Diameter (Ø)									
						3.0	4.0	6.0	8.0	10.0	12.0	16.0	20.0	25.0	
P	1	Non-alloy steel	0.5D	0.2D	Vc	45	50	55	60	55	55	55	60	50	
					fz	0.021	0.033	0.05	0.072	0.103	0.11	0.136	0.14	0.148	
					RPM	4775	3979	2918	2387	1751	1459	1094	955	637	
	2		0.5D	0.2D	Vc	35	40	45	45	45	45	45	45	40	
					fz	0.018	0.029	0.043	0.061	0.089	0.092	0.111	0.12	0.13	
					RPM	3714	3183	2387	1790	1432	1194	895	716	509	
	3-4		0.5D	0.2D	Vc	25	25	30	30	30	30	30	30	25	
					fz	0.015	0.024	0.034	0.052	0.07	0.076	0.092	0.099	0.103	
					RPM	2653	1989	1592	1194	955	796	597	477	318	
	5		0.5D	0.2D	Vc	10	15	15	15	15	15	15	15	15	
					fz	0.013	0.023	0.034	0.046	0.068	0.069	0.083	0.094	0.086	
RPM		1061			1194	796	597	477	398	298	239	191			
6	0.5D	0.2D	Vc	35	40	45	45	45	45	45	45	40			
			fz	0.018	0.029	0.043	0.061	0.089	0.092	0.111	0.12	0.13			
			RPM	3714	3183	2387	1790	1432	1194	895	716	509			
7	0.5D	0.2D	Vc	25	25	30	30	30	30	30	30	25			
			fz	0.015	0.024	0.034	0.052	0.07	0.076	0.092	0.099	0.103			
			RPM	2653	1989	1592	1194	955	796	597	477	318			
8-9	0.5D	0.2D	Vc	10	15	15	15	15	15	15	15	15			
			fz	0.013	0.023	0.034	0.046	0.068	0.069	0.083	0.094	0.086			
			RPM	1061	1194	796	597	477	398	298	239	191			
10	0.5D	0.2D	Vc	35	40	45	45	45	45	45	45	40			
			fz	0.018	0.029	0.043	0.061	0.089	0.092	0.111	0.12	0.13			
			RPM	3714	3183	2387	1790	1432	1194	895	716	509			
11.1	0.5D	0.2D	Vc	10	15	15	15	15	15	15	15	15			
			fz	0.013	0.023	0.034	0.046	0.068	0.069	0.083	0.094	0.086			
			RPM	1061	1194	796	597	477	398	298	239	191			
M	14.1	Stainless steel	0.5D	0.2D	Vc	15	15	15	15	15	15	15	15	15	
					fz	0.014	0.025	0.036	0.049	0.075	0.074	0.091	0.104	0.09	
					RPM	1592	1194	796	597	477	398	298	239	191	
					FEED	45	60	57	58	72	59	54	50	34	
K	15-20	Grey cast iron Nodular cast iron Malleable cast iron	0.5D	0.2D	Vc	35	40	45	45	45	45	45	40		
					fz	0.018	0.029	0.043	0.061	0.089	0.092	0.111	0.12	0.13	
					RPM	3714	3183	2387	1790	1432	1194	895	716	509	
					FEED	134	185	205	218	255	220	199	172	132	

※ The FEED, in long & extra long types, should be reduced by around 50%

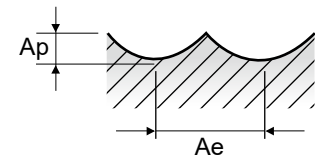

GA936 , GAA29 SERIES **2 FLUTE - SLOTTING**

Vc = m/min.
fz = mm/tooth
RPM = rev./min.
FEED = mm/min.

ISO	VDI 3323	Material Description	Ae	Ap	Parameter	Diameter (Ø)													
						2.0	3.0	4.0	5.0	6.0	8.0	10.0	12.0	14.0	16.0	18.0	20.0	22.0	25.0
P	1	Non-alloy steel	1.0D	0.5D	Vc	45	45	55	60	65	65	65	70	70	70	65	60	60	60
					fz	0.008	0.016	0.027	0.033	0.038	0.053	0.071	0.076	0.083	0.098	0.104	0.116	0.11	0.103
					RPM	7162	4775	4377	3820	3448	2586	2069	1857	1592	1393	1149	955	868	764
					FEED	115	153	236	252	262	274	294	282	264	273	239	222	191	157
	2		1.0D	0.5D	Vc	35	40	45	50	55	55	55	55	55	60	55	50	50	50
					fz	0.008	0.016	0.024	0.031	0.036	0.055	0.074	0.083	0.084	0.085	0.103	0.106	0.106	0.111
					RPM	5570	4244	3581	3183	2918	2188	1751	1459	1251	1194	973	796	723	637
	3-4		1.0D	0.5D	Vc	30	30	40	40	45	45	45	45	45	45	45	45	40	40
					fz	0.008	0.017	0.025	0.036	0.041	0.056	0.079	0.091	0.098	0.101	0.101	0.107	0.104	0.117
					RPM	4775	3183	3183	2546	2387	1790	1432	1194	1023	895	796	716	579	509
	5		1.0D	0.5D	Vc	45	45	55	60	65	65	65	70	70	70	65	60	60	60
fz		0.008			0.016	0.027	0.033	0.038	0.053	0.071	0.076	0.083	0.098	0.104	0.116	0.11	0.103		
RPM		7162			4775	4377	3820	3448	2586	2069	1857	1592	1393	1149	955	868	764		
6	1.0D	0.5D	Vc	35	40	45	50	55	55	55	55	55	60	55	50	50	50		
			fz	0.008	0.016	0.024	0.031	0.036	0.055	0.074	0.083	0.084	0.085	0.103	0.106	0.106	0.111		
			RPM	5570	4244	3581	3183	2918	2188	1751	1459	1251	1194	973	796	723	637		
7	1.0D	0.5D	Vc	30	30	40	40	45	45	45	45	45	45	45	45	40	40		
			fz	0.008	0.017	0.025	0.036	0.041	0.056	0.079	0.091	0.098	0.101	0.101	0.107	0.104	0.117		
			RPM	4775	3183	3183	2546	2387	1790	1432	1194	1023	895	796	716	579	509		
8	1.0D	0.5D	Vc	45	45	55	60	65	65	65	70	70	70	65	60	60	60		
			fz	0.008	0.016	0.027	0.033	0.038	0.053	0.071	0.076	0.083	0.098	0.104	0.116	0.11	0.103		
			RPM	7162	4775	4377	3820	3448	2586	2069	1857	1592	1393	1149	955	868	764		
9	1.0D	0.5D	Vc	35	40	45	50	55	55	55	55	55	60	55	50	50	50		
			fz	0.008	0.016	0.024	0.031	0.036	0.055	0.074	0.083	0.084	0.085	0.103	0.106	0.106	0.111		
			RPM	5570	4244	3581	3183	2918	2188	1751	1459	1251	1194	973	796	723	637		
10	1.0D	0.5D	Vc	35	40	45	50	55	55	55	55	55	60	55	50	50	50		
			fz	0.008	0.016	0.024	0.031	0.036	0.055	0.074	0.083	0.084	0.085	0.103	0.106	0.106	0.111		
			RPM	5570	4244	3581	3183	2918	2188	1751	1459	1251	1194	973	796	723	637		
11.1	1.0D	0.5D	Vc	45	45	55	60	65	65	65	70	70	70	65	60	60	60		
			fz	0.008	0.016	0.027	0.033	0.038	0.053	0.071	0.076	0.083	0.098	0.104	0.116	0.11	0.103		
			RPM	7162	4775	4377	3820	3448	2586	2069	1857	1592	1393	1149	955	868	764		
K	15-20	Grey cast iron Nodular cast iron Malleable cast iron	1.0D	0.5D	Vc	35	40	45	50	55	55	55	55	55	60	55	50	50	50
					fz	0.008	0.016	0.024	0.031	0.036	0.055	0.074	0.083	0.084	0.085	0.103	0.106	0.106	0.111
					RPM	5570	4244	3581	3183	2918	2188	1751	1459	1251	1194	973	796	723	637
K	15-20	Grey cast iron Nodular cast iron Malleable cast iron	1.0D	0.5D	FEED	89	136	172	197	210	241	259	242	210	203	200	169	153	141

※ The FEED, in long & extra long types, should be reduced by around 50%

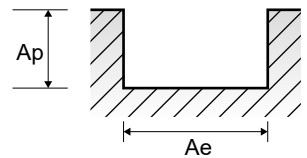

E9936 , E9A29 SERIES 2 FLUTE - SLOTTING

Vc = m/min.
fz = mm/tooth
RPM = rev/min.
FEED = mm/min.

ISO	VDI 3323	Material Description	Ae	Ap	Parameter	Diameter (Ø)																
						2.0	3.0	4.0	5.0	6.0	8.0	10.0	12.0	14.0	16.0	18.0	20.0	22.0	25.0			
P	1	Non-alloy steel	1.0D	0.5D	Vc	30	30	35	40	45	45	45	45	50	45	45	40	40	40			
					fz	0.007	0.015	0.024	0.031	0.035	0.047	0.064	0.071	0.073	0.089	0.094	0.102	0.096	0.093			
					RPM	4775	3183	2785	2546	2387	1790	1432	1194	1137	895	796	637	579	509			
	2		1.0D	0.5D	Vc	25	25	30	35	40	40	40	40	35	40	35	35	35	35			
					fz	0.007	0.015	0.023	0.028	0.034	0.05	0.069	0.075	0.082	0.09	0.094	0.093	0.094	0.099			
					RPM	3979	2653	2387	2228	2122	1592	1273	1061	796	796	619	557	506	446			
	3-4		1.0D	0.5D	Vc	20	20	25	30	30	30	30	30	30	30	30	30	30	25			
					fz	0.008	0.017	0.024	0.032	0.038	0.052	0.07	0.081	0.088	0.092	0.094	0.099	0.094	0.103			
					RPM	3183	2122	1989	1910	1592	1194	955	796	682	597	531	477	434	318			
	5		1.0D	0.5D	Vc	15	15	15	15	20	20	20	20	20	20	20	20	20	20			
					fz	0.01	0.016	0.023	0.03	0.033	0.047	0.067	0.07	0.076	0.086	0.081	0.092	0.093	0.094			
RPM		2387			1592	1194	955	1061	796	637	531	455	398	354	318	289	255					
6	1.0D	0.5D	Vc	25	25	30	35	40	40	40	40	35	40	35	35	35	35					
			fz	0.007	0.015	0.023	0.028	0.034	0.05	0.069	0.075	0.082	0.09	0.094	0.093	0.094	0.099					
			RPM	3979	2653	2387	2228	2122	1592	1273	1061	796	796	619	557	506	446					
7	1.0D	0.5D	Vc	20	20	25	30	30	30	30	30	30	30	30	30	30	25					
			fz	0.008	0.017	0.024	0.032	0.038	0.052	0.07	0.081	0.088	0.092	0.094	0.099	0.094	0.103					
			RPM	3183	2122	1989	1910	1592	1194	955	796	682	597	531	477	434	318					
8	1.0D	0.5D	Vc	15	15	15	15	20	20	20	20	20	20	20	20	20	20					
			fz	0.01	0.016	0.023	0.03	0.033	0.047	0.067	0.07	0.076	0.086	0.081	0.092	0.093	0.094					
			RPM	2387	1592	1194	955	1061	796	637	531	455	398	354	318	289	255					
9	1.0D	0.5D	Vc	10	10	15	15	15	15	15	15	15	15	15	15	15	15					
			fz	0.01	0.017	0.021	0.025	0.037	0.046	0.068	0.069	0.074	0.083	0.083	0.083	0.083	0.086					
			RPM	1592	1061	1194	955	796	597	477	398	341	298	265	239	217	191					
10	1.0D	High alloyed steel, and tool steel	0.5D	Vc	25	25	30	35	40	40	40	40	35	40	35	35	35	35				
				fz	0.007	0.015	0.023	0.028	0.034	0.05	0.069	0.075	0.082	0.09	0.094	0.093	0.094	0.099				
				RPM	3979	2653	2387	2228	2122	1592	1273	1061	796	796	619	557	506	446				
11.1	1.0D		0.5D	Vc	15	15	15	15	20	20	20	20	20	20	20	20	20	20				
				fz	0.01	0.016	0.023	0.03	0.033	0.047	0.067	0.07	0.076	0.086	0.081	0.092	0.093	0.094				
				RPM	2387	1592	1194	955	1061	796	637	531	455	398	354	318	289	255				
K	15-20		Grey cast iron Nodular cast iron Malleable cast iron	1.0D	0.5D	Vc	25	25	30	35	40	40	40	40	35	40	35	35	35	35		
						fz	0.007	0.015	0.023	0.028	0.034	0.05	0.069	0.075	0.082	0.09	0.094	0.093	0.094	0.099		
						RPM	3979	2653	2387	2228	2122	1592	1273	1061	796	796	619	557	506	446		

※ The FEED, in long & extra long types, should be reduced by around 50%

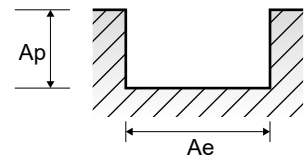

GA942 , GAA30 SERIES **3 FLUTE - SLOTTING**

Vc = m/min.
fz = mm/tooth
RPM = rev./min.
FEED = mm/min.

ISO	VDI 3323	Material Description	Ae	Ap	Parameter	Diameter (Ø)													
						2.0	3.0	4.0	5.0	6.0	8.0	10.0	12.0	14.0	16.0	18.0	20.0	22.0	25.0
P	1	Non-alloy steel	1.0D	0.5D	Vc	40	45	55	60	65	65	65	70	70	70	65	60	60	60
					fz	0.004	0.007	0.011	0.014	0.023	0.031	0.033	0.051	0.052	0.059	0.07	0.081	0.091	0.107
					FEED	76	100	144	160	238	241	205	284	248	246	241	232	237	245
	2		1.0D	0.5D	Vc	35	35	45	50	55	55	55	55	60	60	50	50	50	50
					fz	0.003	0.007	0.011	0.014	0.023	0.032	0.039	0.053	0.054	0.061	0.071	0.08	0.089	0.111
					FEED	5570	3714	3581	3183	2918	2188	1751	1459	1364	1194	884	796	723	637
	3-4		1.0D	0.5D	Vc	30	30	40	40	45	45	45	45	45	45	45	45	40	40
					fz	0.003	0.005	0.009	0.012	0.02	0.028	0.038	0.047	0.053	0.056	0.063	0.067	0.083	0.109
					FEED	4775	3183	3183	2546	2387	1790	1432	1194	1023	895	796	716	579	509
	5		1.0D	0.5D	Vc	20	20	25	25	25	30	30	30	30	30	30	30	30	30
					fz	0.004	0.007	0.009	0.012	0.021	0.03	0.043	0.052	0.056	0.061	0.063	0.07	0.079	0.094
FEED		3183			2122	1989	1592	1326	1194	955	796	682	597	531	477	434	382		
6	1.0D	0.5D	Vc	35	35	45	50	55	55	55	55	60	60	50	50	50	50		
			fz	0.003	0.007	0.011	0.014	0.023	0.032	0.039	0.053	0.054	0.061	0.071	0.08	0.089	0.111		
			FEED	5570	3714	3581	3183	2918	2188	1751	1459	1364	1194	884	796	723	637		
7	1.0D	0.5D	Vc	30	30	40	40	45	45	45	45	45	45	45	45	40	40		
			fz	0.003	0.005	0.009	0.012	0.02	0.028	0.038	0.047	0.053	0.056	0.063	0.067	0.083	0.109		
			FEED	4775	3183	3183	2546	2387	1790	1432	1194	1023	895	796	716	579	509		
8	1.0D	0.5D	Vc	20	20	25	25	25	30	30	30	30	30	30	30	30	30		
			fz	0.004	0.007	0.009	0.012	0.021	0.03	0.043	0.052	0.056	0.061	0.063	0.07	0.079	0.094		
			FEED	3183	2122	1989	1592	1326	1194	955	796	682	597	531	477	434	382		
9	1.0D	0.5D	Vc	10	15	20	20	20	20	20	20	20	20	25	25	20	20		
			fz	0.005	0.008	0.012	0.014	0.023	0.032	0.045	0.053	0.057	0.064	0.067	0.074	0.09	0.113		
			FEED	1592	1592	1592	1273	1061	796	637	531	455	398	442	398	289	255		
10	1.0D	0.5D	Vc	35	35	45	50	55	55	55	55	60	60	50	50	50	50		
			fz	0.003	0.007	0.011	0.014	0.023	0.032	0.039	0.053	0.054	0.061	0.071	0.08	0.089	0.111		
			FEED	5570	3714	3581	3183	2918	2188	1751	1459	1364	1194	884	796	723	637		
11.1	1.0D	0.5D	Vc	20	20	25	25	25	30	30	30	30	30	30	30	30	30		
			fz	0.004	0.007	0.009	0.012	0.021	0.03	0.043	0.052	0.056	0.061	0.063	0.07	0.079	0.094		
			FEED	3183	2122	1989	1592	1326	1194	955	796	682	597	531	477	434	382		
K	15-20	Grey cast iron Nodular cast iron Malleable cast iron	1.0D	0.5D	Vc	35	35	45	50	55	55	55	60	60	50	50	50	50	
					fz	0.003	0.007	0.011	0.014	0.023	0.032	0.039	0.053	0.054	0.061	0.071	0.08	0.089	0.111
					FEED	5570	3714	3581	3183	2918	2188	1751	1459	1364	1194	884	796	723	637

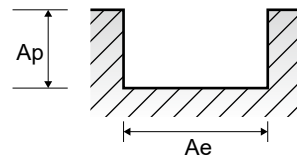

Vc = m/min.
fz = mm/tooth
RPM = rev./min.
FEED = mm/min.

GA942 , GAA30 SERIES

3 FLUTE - SIDE CUTTING

ISO	VDI 3323	Material Description	Ae	Ap	Parameter	Diameter (Ø)																
						2.0	3.0	4.0	5.0	6.0	8.0	10.0	12.0	14.0	16.0	18.0	20.0	22.0	25.0			
P	1	Non-alloy steel	0.1D	1.5D	Vc	50	55	65	75	80	80	80	80	80	80	80	80	75	80	80	80	
					fz	0.004	0.008	0.012	0.015	0.024	0.034	0.047	0.056	0.065	0.069	0.077	0.08	0.09	0.11			
					RPM	7958	5836	5173	4775	4244	3183	2546	2122	1819	1592	1326	1273	1157	1019			
	2		0.1D	1.5D	Vc	45	45	55	65	70	65	65	70	65	65	65	65	65	65	65	65	
					fz	0.004	0.008	0.012	0.015	0.023	0.035	0.046	0.056	0.063	0.071	0.077	0.081	0.093	0.109			
					RPM	7162	4775	4377	4138	3714	2586	2069	1857	1478	1293	1149	1035	940	828			
	3-4		0.1D	1.5D	Vc	35	35	45	45	50	50	50	55	50	50	50	50	50	50	50	50	
					fz	0.004	0.007	0.01	0.014	0.024	0.033	0.044	0.055	0.061	0.067	0.073	0.081	0.088	0.111			
					RPM	5570	3714	3581	2865	2653	1989	1592	1459	1137	995	884	796	723	637			
	5		0.1D	1.5D	Vc	25	25	30	30	35	35	30	35	35	35	35	35	35	35	30	35	
					fz	0.004	0.008	0.011	0.014	0.023	0.036	0.05	0.056	0.06	0.071	0.075	0.08	0.092	0.107			
RPM		3979			2653	2387	1910	1857	1393	955	928	796	696	619	557	434	446					
6	0.1D	1.5D	Vc	45	45	55	65	70	65	65	70	65	65	65	65	65	65	65	65			
			fz	0.004	0.008	0.012	0.015	0.023	0.035	0.046	0.056	0.063	0.071	0.077	0.081	0.093	0.109					
			RPM	7162	4775	4377	4138	3714	2586	2069	1857	1478	1293	1149	1035	940	828					
7	0.1D	1.5D	Vc	35	35	45	45	50	50	50	55	50	50	50	50	50	50	50	50			
			fz	0.004	0.007	0.01	0.014	0.024	0.033	0.044	0.055	0.061	0.067	0.073	0.081	0.088	0.111					
			RPM	5570	3714	3581	2865	2653	1989	1592	1459	1137	995	884	796	723	637					
8	0.1D	1.5D	Vc	25	25	30	30	35	35	30	35	35	35	35	35	35	35	30	35			
			fz	0.004	0.008	0.011	0.014	0.023	0.036	0.05	0.056	0.06	0.071	0.075	0.08	0.092	0.107					
			RPM	3979	2653	2387	1910	1857	1393	955	928	796	696	619	557	434	446					
9	0.1D	1.5D	Vc	15	20	25	25	30	30	30	30	30	30	30	30	30	30	30	30			
			fz	0.006	0.01	0.013	0.015	0.022	0.035	0.047	0.056	0.063	0.07	0.073	0.083	0.092	0.111					
			RPM	2387	2122	1989	1592	1592	1194	955	796	682	597	531	477	434	382					
10	0.1D	1.5D	Vc	45	45	55	65	70	65	65	70	65	65	65	65	65	65	65	65			
			fz	0.004	0.008	0.012	0.015	0.023	0.035	0.046	0.056	0.063	0.071	0.077	0.081	0.093	0.109					
			RPM	7162	4775	4377	4138	3714	2586	2069	1857	1478	1293	1149	1035	940	828					
11.1	0.1D	1.5D	Vc	25	25	30	30	35	35	30	35	35	35	35	35	35	35	30	35			
			fz	0.004	0.008	0.011	0.014	0.023	0.036	0.05	0.056	0.06	0.071	0.075	0.08	0.092	0.107					
			RPM	3979	2653	2387	1910	1857	1393	955	928	796	696	619	557	434	446					
K	15-20	Grey cast iron Nodular cast iron Malleable cast iron	0.1D	1.5D	Vc	45	45	55	65	70	65	65	70	65	65	65	65	65	65	65		
					fz	0.004	0.008	0.012	0.015	0.023	0.035	0.046	0.056	0.063	0.071	0.077	0.081	0.093	0.109			
					RPM	7162	4775	4377	4138	3714	2586	2069	1857	1478	1293	1149	1035	940	828			
					FEED	86	115	158	186	256	272	286	312	279	275	266	251	262	271			

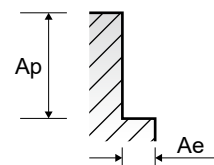

E9942 , E9A30 SERIES **3 FLUTE - SLOTTING**

Vc = m/min.
fz = mm/tooth
RPM = rev./min.
FEED = mm/min.

ISO	VDI 3323	Material Description	Ae	Ap	Parameter	Diameter (Ø)													
						2.0	3.0	4.0	5.0	6.0	8.0	10.0	12.0	14.0	16.0	18.0	20.0	22.0	25.0
P	1	Non-alloy steel	1.0D	0.5D	Vc	30	30	35	40	45	45	45	45	45	45	45	40	40	40
					fz	0.003	0.007	0.01	0.013	0.021	0.028	0.037	0.047	0.048	0.054	0.064	0.076	0.085	0.096
					FEED	4775	3183	2785	2546	2387	1790	1432	1194	1023	895	796	637	579	509
	2		1.0D	0.5D	Vc	25	25	30	35	35	40	40	40	40	40	35	35	35	35
					fz	0.003	0.007	0.01	0.012	0.021	0.029	0.036	0.048	0.048	0.056	0.066	0.075	0.08	0.101
					FEED	3979	2653	2387	2228	1857	1592	1273	1061	909	796	619	557	506	446
	3-4		1.0D	0.5D	Vc	20	30	25	30	30	30	30	30	30	30	30	30	30	25
					fz	0.003	0.003	0.008	0.01	0.018	0.026	0.035	0.043	0.049	0.052	0.06	0.059	0.077	0.098
					FEED	3183	3183	1989	1910	1592	1194	955	796	682	597	531	477	434	318
	5		1.0D	0.5D	Vc	15	15	15	15	20	20	20	20	20	20	20	20	20	20
					fz	0.003	0.007	0.009	0.012	0.018	0.028	0.038	0.047	0.048	0.057	0.057	0.061	0.074	0.09
FEED		2387			1592	1194	955	1061	796	637	531	455	398	354	318	289	255		
6	1.0D	0.5D	Vc	25	25	30	35	35	40	40	40	40	40	35	35	35	35		
			fz	0.003	0.007	0.01	0.012	0.021	0.029	0.036	0.048	0.048	0.056	0.066	0.075	0.08	0.101		
			FEED	3979	2653	2387	2228	1857	1592	1273	1061	909	796	619	557	506	446		
7	1.0D	0.5D	Vc	20	30	25	30	30	30	30	30	30	30	30	30	30	25		
			fz	0.003	0.003	0.008	0.01	0.018	0.026	0.035	0.043	0.049	0.052	0.06	0.059	0.077	0.098		
			FEED	3183	3183	1989	1910	1592	1194	955	796	682	597	531	477	434	318		
8	1.0D	0.5D	Vc	15	15	15	15	20	20	20	20	20	20	20	20	20	20		
			fz	0.003	0.007	0.009	0.012	0.018	0.028	0.038	0.047	0.048	0.057	0.057	0.061	0.074	0.09		
			FEED	2387	1592	1194	955	1061	796	637	531	455	398	354	318	289	255		
9	1.0D	0.5D	Vc	10	10	15	15	15	15	15	15	15	15	15	15	15	15		
			fz	0.005	0.008	0.012	0.013	0.02	0.03	0.042	0.049	0.053	0.061	0.062	0.068	0.085	0.108		
			FEED	1592	1061	1194	955	796	597	477	398	341	298	265	239	217	191		
10	1.0D	0.5D	Vc	25	25	30	35	35	40	40	40	40	40	35	35	35	35		
			fz	0.003	0.007	0.01	0.012	0.021	0.029	0.036	0.048	0.048	0.056	0.066	0.075	0.08	0.101		
			FEED	3979	2653	2387	2228	1857	1592	1273	1061	909	796	619	557	506	446		
11.1	1.0D	0.5D	Vc	15	15	15	15	20	20	20	20	20	20	20	20	20	20		
			fz	0.003	0.007	0.009	0.012	0.018	0.028	0.038	0.047	0.048	0.057	0.057	0.061	0.074	0.09		
			FEED	2387	1592	1194	955	1061	796	637	531	455	398	354	318	289	255		
K	15-20	Grey cast iron Nodular cast iron Malleable cast iron	1.0D	0.5D	Vc	25	25	30	35	35	40	40	40	40	40	35	35	35	
					fz	0.003	0.007	0.01	0.012	0.021	0.029	0.036	0.048	0.048	0.056	0.066	0.075	0.08	0.101
					FEED	3979	2653	2387	2228	1857	1592	1273	1061	909	796	619	557	506	446

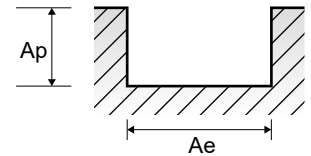

E9942 , E9A30 SERIES

3 FLUTE - SIDE CUTTING

Vc = m/min.
fz = mm/tooth
RPM = rev./min.
FEED = mm/min.

ISO	VDI 3323	Material Description	Ae	Ap	Parameter	Diameter (Ø)															
						2.0	3.0	4.0	5.0	6.0	8.0	10.0	12.0	14.0	16.0	18.0	20.0	22.0	25.0		
P	1	Non-alloy steel	0.1D	1.5D	Vc	50	55	65	75	80	80	80	80	80	80	80	75	80	80	80	
					fz	0.004	0.008	0.012	0.015	0.024	0.034	0.047	0.056	0.065	0.069	0.077	0.08	0.09	0.11		
					RPM	7958	5836	5173	4775	4244	3183	2546	2122	1819	1592	1326	1273	1157	1019		
	2		0.1D	1.5D	Vc	45	45	55	65	70	65	65	70	65	65	65	65	65	65	65	
					fz	0.004	0.008	0.012	0.015	0.023	0.035	0.046	0.056	0.063	0.071	0.077	0.081	0.093	0.109		
					RPM	7162	4775	4377	4138	3714	2586	2069	1857	1478	1293	1149	1035	940	828		
	3-4		0.1D	1.5D	Vc	35	35	45	45	50	50	50	55	50	50	50	50	50	50	50	
					fz	0.004	0.007	0.01	0.014	0.024	0.033	0.044	0.055	0.061	0.067	0.073	0.081	0.088	0.111		
					RPM	5570	3714	3581	2865	2653	1989	1592	1459	1137	995	884	796	723	637		
	5		0.1D	1.5D	Vc	25	25	30	30	35	35	30	35	35	35	35	35	30	35	35	
					fz	0.004	0.008	0.011	0.014	0.023	0.036	0.05	0.056	0.06	0.071	0.075	0.08	0.092	0.107		
RPM		3979			2653	2387	1910	1857	1393	955	928	796	696	619	557	434	446				
6	0.1D	1.5D	Vc	45	45	55	65	70	65	65	70	65	65	65	65	65	65	65			
			fz	0.004	0.008	0.012	0.015	0.023	0.035	0.046	0.056	0.063	0.071	0.077	0.081	0.093	0.109				
			RPM	7162	4775	4377	4138	3714	2586	2069	1857	1478	1293	1149	1035	940	828				
7	0.1D	1.5D	Vc	35	35	45	45	50	50	50	55	50	50	50	50	50	50	50			
			fz	0.004	0.007	0.01	0.014	0.024	0.033	0.044	0.055	0.061	0.067	0.073	0.081	0.088	0.111				
			RPM	5570	3714	3581	2865	2653	1989	1592	1459	1137	995	884	796	723	637				
8	0.1D	1.5D	Vc	25	25	30	30	35	35	30	35	35	35	35	35	30	35	35			
			fz	0.004	0.008	0.011	0.014	0.023	0.036	0.05	0.056	0.06	0.071	0.075	0.08	0.092	0.107				
			RPM	3979	2653	2387	1910	1857	1393	955	928	796	696	619	557	434	446				
9	0.1D	1.5D	Vc	15	20	25	25	30	30	30	30	30	30	30	30	30	30	30			
			fz	0.006	0.01	0.013	0.015	0.022	0.035	0.047	0.056	0.063	0.07	0.073	0.083	0.092	0.111				
			RPM	2387	2122	1989	1592	1592	1194	955	796	682	597	531	477	434	382				
10	0.1D	1.5D	Vc	45	45	55	65	70	65	65	70	65	65	65	65	65	65	65			
			fz	0.004	0.008	0.012	0.015	0.023	0.035	0.046	0.056	0.063	0.071	0.077	0.081	0.093	0.109				
			RPM	7162	4775	4377	4138	3714	2586	2069	1857	1478	1293	1149	1035	940	828				
11.1	0.1D	1.5D	Vc	25	25	30	30	35	35	30	35	35	35	35	35	30	35	35			
			fz	0.004	0.008	0.011	0.014	0.023	0.036	0.05	0.056	0.06	0.071	0.075	0.08	0.092	0.107				
			RPM	3979	2653	2387	1910	1857	1393	955	928	796	696	619	557	434	446				
K	15-20	Grey cast iron Nodular cast iron Malleable cast iron	0.1D	1.5D	Vc	45	45	55	65	70	65	65	70	65	65	65	65	65	65		
					fz	0.004	0.008	0.012	0.015	0.023	0.035	0.046	0.056	0.063	0.071	0.077	0.081	0.093	0.109		
					RPM	7162	4775	4377	4138	3714	2586	2069	1857	1478	1293	1149	1035	940	828		
					FEED	86	115	158	186	256	272	286	312	279	275	266	251	262	271		

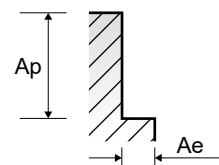

CBN END MILLS

i-Xmill END MILLS

i-SMART MODULAR END MILLS

X5070 END MILLS

4G MILL END MILLS

X-POWER PRO END MILLS

TitaNox-POWER END MILLS

JET-POWER END MILLS

V7 PLUS END MILLS

ALU-POWER HPC END MILLS

ALU-POWER END MILLS

D-POWER GRAPHITE END MILLS

D-POWER CFRP END MILLS

ROUTERS

CRX S END MILLS

K-2 END MILLS

ONLY ONE COATED PM60 END MILLS

TANK-POWER END MILLS

GENERAL HSS END MILLS

MILLING CUTTERS

TECHNICAL DATA

GA938 , GAA31 SERIES **4 FLUTE - SIDE CUTTING**

Vc = m/min.
fz = mm/tooth
RPM = rev./min.
FEED = mm/min.

ISO	VDI 3323	Material Description	Ae	Ap	Parameter	Diameter (Ø)													
						2.0	3.0	4.0	5.0	6.0	8.0	10.0	12.0	14.0	16.0	18.0	20.0	22.0	25.0
P	1	Non-alloy steel	0.1D	1.5D	Vc	60	60	65	70	75	80	70	75	80	80	85	80	75	80
					fz	0.008	0.016	0.023	0.029	0.035	0.046	0.068	0.071	0.076	0.08	0.077	0.088	0.098	0.093
					RPM	9549	6366	5173	4456	3979	3183	2228	1989	1819	1592	1503	1273	1085	1019
	2		0.1D	1.5D	Vc	55	55	60	65	70	65	65	70	70	70	70	65	65	65
					fz	0.007	0.015	0.021	0.026	0.031	0.046	0.063	0.067	0.072	0.077	0.08	0.088	0.084	0.091
					RPM	8754	5836	4775	4138	3714	2586	2069	1857	1592	1393	1238	1035	940	828
	3-4		0.1D	1.5D	Vc	40	40	45	45	50	50	50	55	50	50	50	50	45	50
					fz	0.007	0.014	0.021	0.028	0.032	0.046	0.059	0.066	0.08	0.085	0.087	0.088	0.094	0.091
					RPM	6366	4244	3581	2865	2653	1989	1592	1459	1137	995	884	796	651	637
	5		0.1D	1.5D	Vc	25	25	30	30	35	35	30	35	35	35	35	35	30	35
					fz	0.008	0.017	0.022	0.028	0.032	0.043	0.066	0.067	0.073	0.081	0.077	0.083	0.085	0.089
RPM		3979			2653	2387	1910	1857	1393	955	928	796	696	619	557	434	446		
6	0.1D	1.5D	Vc	55	55	60	65	70	65	65	70	70	70	70	65	65	65		
			fz	0.007	0.015	0.021	0.026	0.031	0.046	0.063	0.067	0.072	0.077	0.08	0.088	0.084	0.091		
			RPM	8754	5836	4775	4138	3714	2586	2069	1857	1592	1393	1238	1035	940	828		
7	0.1D	1.5D	Vc	40	40	45	45	50	50	50	55	50	50	50	50	45	50		
			fz	0.007	0.014	0.021	0.028	0.032	0.046	0.059	0.066	0.08	0.085	0.087	0.088	0.094	0.091		
			RPM	6366	4244	3581	2865	2653	1989	1592	1459	1137	995	884	796	651	637		
8	0.1D	1.5D	Vc	25	25	30	30	35	35	30	35	35	35	35	35	30	35		
			fz	0.008	0.017	0.022	0.028	0.032	0.043	0.066	0.067	0.073	0.081	0.077	0.083	0.085	0.089		
			RPM	3979	2653	2387	1910	1857	1393	955	928	796	696	619	557	434	446		
9	0.1D	1.5D	Vc	20	25	25	25	25	30	30	25	30	30	30	30	30	30		
			fz	0.006	0.013	0.019	0.024	0.031	0.04	0.056	0.064	0.067	0.075	0.075	0.08	0.081	0.087		
			RPM	3183	2653	1989	1592	1326	1194	955	663	682	597	531	477	434	382		
10	0.1D	1.5D	Vc	55	55	60	65	70	65	65	70	70	70	70	65	65	65		
			fz	0.007	0.015	0.021	0.026	0.031	0.046	0.063	0.067	0.072	0.077	0.08	0.088	0.084	0.091		
			RPM	8754	5836	4775	4138	3714	2586	2069	1857	1592	1393	1238	1035	940	828		
11.1	0.1D	1.5D	Vc	25	25	30	30	35	35	30	35	35	35	35	35	30	35		
			fz	0.008	0.017	0.022	0.028	0.032	0.043	0.066	0.067	0.073	0.081	0.077	0.083	0.085	0.089		
			RPM	3979	2653	2387	1910	1857	1393	955	928	796	696	619	557	434	446		
K	15-20	Grey cast iron Nodular cast iron Malleable cast iron	0.1D	1.5D	Vc	55	55	60	65	70	65	65	70	70	70	65	65	65	
					fz	0.007	0.015	0.021	0.026	0.031	0.046	0.063	0.067	0.072	0.077	0.08	0.088	0.084	0.091
					RPM	8754	5836	4775	4138	3714	2586	2069	1857	1592	1393	1238	1035	940	828

※ The FEED, in long & extra long types, should be reduced by around 50%

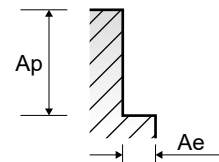

GA941 , GAA35 , GAA33 , GAA34 SERIES MULTI FLUTE ROUGHING - SIDE CUTTING

Vc = m/min.
fz = mm/tooth
RPM = rev./min.
FEED = mm/min.

ISO	VDI 3323	Material Description	Ae	Ap	Parameter	Diameter (Ø)										
						6.0	8.0	10.0	12.0	22.0	25.0	18.0	20.0	22.0	25.0	
P	1	Non-alloy steel	0.5D	1.5D	Vc	55	60	60	60	60	60	60	60	60	60	60
					fz	0.027	0.04	0.055	0.065	0.074	0.086	0.099	0.111	0.096	0.105	
					RPM	2918	2387	1910	1592	1364	1194	1061	955	868	764	
	2		Vc	40	50	45	45	45	50	50	50	45	45			
			fz	0.027	0.04	0.053	0.069	0.079	0.087	0.093	0.109	0.102	0.105			
			RPM	2122	1989	1432	1194	1023	995	884	796	651	573			
	3-4		Vc	30	35	35	35	35	35	35	35	30	35			
			fz	0.024	0.038	0.046	0.064	0.076	0.087	0.094	0.108	0.098	0.105			
			RPM	1592	1393	1114	928	796	619	557	434	446				
	5		Vc	25	25	30	30	30	30	30	30	30	30			
fz		0.027	0.04	0.045	0.061	0.071	0.082	0.092	0.102	0.09	0.1					
RPM		1326	995	955	796	682	597	531	477	434	382					
6	Vc	40	50	45	45	45	50	50	50	45	45					
	fz	0.027	0.04	0.053	0.069	0.079	0.087	0.093	0.109	0.102	0.105					
	RPM	2122	1989	1432	1194	1023	995	884	796	651	573					
7	Vc	30	35	35	35	35	35	35	35	30	35					
	fz	0.024	0.038	0.046	0.064	0.076	0.087	0.094	0.108	0.098	0.105					
	RPM	1592	1393	1114	928	796	619	557	434	446						
8-9	Vc	25	25	30	30	30	30	30	30	30	30					
	fz	0.027	0.04	0.045	0.061	0.071	0.082	0.092	0.102	0.09	0.1					
	RPM	1326	995	955	796	682	597	531	477	434	382					
10	Vc	40	50	45	45	45	50	50	50	45	45					
	fz	0.027	0.04	0.053	0.069	0.079	0.087	0.093	0.109	0.102	0.105					
	RPM	2122	1989	1432	1194	1023	995	884	796	651	573					
11.1	Vc	25	25	30	30	30	30	30	30	30	30					
	fz	0.027	0.04	0.045	0.061	0.071	0.082	0.092	0.102	0.09	0.1					
	RPM	1326	995	955	796	682	597	531	477	434	382					
M	14.1	Stainless steel	0.5D	1.5D	Vc	25	30	30	30	30	30	30	30	30	30	
					fz	0.025	0.039	0.045	0.064	0.074	0.085	0.093	0.107	0.095	0.103	
					RPM	1326	1194	955	796	682	597	531	477	434	382	
K	15-20	Grey cast iron Nodular cast iron Malleable cast iron	0.5D	1.5D	Vc	40	50	45	45	45	50	50	50	45	45	
					fz	0.027	0.04	0.053	0.069	0.079	0.087	0.093	0.109	0.102	0.105	
					RPM	2122	1989	1432	1194	1023	995	884	796	651	573	
FEED						172	239	304	329	323	346	329	347	332	301	

※ The FEED, in long & extra long types, should be reduced by around 50%

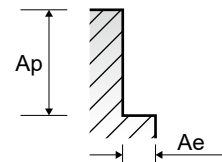

E9941, E9A35, E9A33, E9A34 SERIES

MULTI FLUTE ROUGHING - SIDE CUTTING

Vc = m/min.
fz = mm/tooth
RPM = rev./min.
FEED = mm/min.

ISO	VDI 3323	Material Description	Ae	Ap	Parameter	Diameter (Ø)										
						6.0	8.0	10.0	12.0	22.0	25.0	18.0	20.0	22.0	25.0	
P	1	Non-alloy steel	0.5D	1.5D	Vc	35	40	40	40	40	40	40	40	40	40	40
					fz	0.018	0.028	0.05	0.059	0.056	0.063	0.061	0.067	0.072	0.08	
					RPM	1857	1592	1273	1061	909	796	707	637	579	509	
	FEED		100	134	255	250	204	201	173	171	208	204				
	2		0.5D	1.5D	Vc	30	35	30	30	30	30	35	30	30	30	
					fz	0.018	0.027	0.049	0.063	0.058	0.064	0.056	0.067	0.078	0.081	
					RPM	1592	1393	955	796	682	597	619	477	434	382	
	FEED		86	113	187	201	158	153	139	128	169	155				
	3-4		0.5D	1.5D	Vc	20	25	20	25	20	25	25	25	20	20	
					fz	0.017	0.028	0.044	0.058	0.055	0.062	0.057	0.065	0.073	0.08	
					RPM	1061	995	637	663	455	497	442	398	289	255	
FEED	54	84	112	154	100	123	101	103	106	102						
5	0.5D	1.5D	Vc	15	20	20	20	20	20	20	20	20	20			
			fz	0.018	0.027	0.042	0.055	0.051	0.059	0.056	0.061	0.068	0.076			
			RPM	796	796	637	531	455	398	354	318	289	255			
FEED	43	64	107	117	93	94	79	78	98	97						
6	0.5D	1.5D	Vc	30	35	30	30	30	30	35	30	30	30			
			fz	0.018	0.027	0.049	0.063	0.058	0.064	0.056	0.067	0.078	0.081			
			RPM	1592	1393	955	796	682	597	619	477	434	382			
FEED	86	113	187	201	158	153	139	128	169	155						
7	0.5D	1.5D	Vc	20	25	20	25	20	25	25	25	20	20			
			fz	0.017	0.028	0.044	0.058	0.055	0.062	0.057	0.065	0.073	0.08			
			RPM	1061	995	637	663	455	497	442	398	289	255			
FEED	54	84	112	154	100	123	101	103	106	102						
8-9	0.5D	1.5D	Vc	15	20	20	20	20	20	20	20	20	20			
			fz	0.018	0.027	0.042	0.055	0.051	0.059	0.056	0.061	0.068	0.076			
			RPM	796	796	637	531	455	398	354	318	289	255			
FEED	43	64	107	117	93	94	79	78	98	97						
10	0.5D	1.5D	Vc	30	35	30	30	30	30	35	30	30	30			
			fz	0.018	0.027	0.049	0.063	0.058	0.064	0.056	0.067	0.078	0.081			
			RPM	1592	1393	955	796	682	597	619	477	434	382			
FEED	86	113	187	201	158	153	139	128	169	155						
11.1	0.5D	1.5D	Vc	15	20	20	20	20	20	20	20	20	20			
			fz	0.018	0.027	0.042	0.055	0.051	0.059	0.056	0.061	0.068	0.076			
			RPM	796	796	637	531	455	398	354	318	289	255			
FEED	43	64	107	117	93	94	79	78	98	97						
M	14.1	Stainless steel	0.5D	1.5D	Vc	20	20	20	20	20	20	20	20	20	20	
					fz	0.02	0.03	0.045	0.065	0.06	0.069	0.064	0.073	0.081	0.086	
					RPM	1061	796	637	531	455	398	354	318	289	255	
FEED	64	72	115	138	109	110	91	93	117	109						
K	15-20	Grey cast iron Nodular cast iron Malleable cast iron	0.5D	1.5D	Vc	30	35	30	30	30	30	35	30	30	30	
					fz	0.018	0.027	0.049	0.063	0.058	0.064	0.056	0.067	0.078	0.081	
					RPM	1592	1393	955	796	682	597	619	477	434	382	
FEED	86	113	187	201	158	153	139	128	169	155						

※ The FEED, in long & extra long types, should be reduced by around 50%

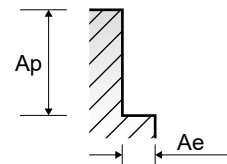

GAA26 SERIES **MULTI FLUTE ROUGHING - SIDE CUTTING**

Vc = m/min.
fz = mm/tooth
RPM = rev./min.
FEED = mm/min.

ISO	VDI 3323	Material Description	Ae	Ap	Parameter	Diameter (Ø)									
						6.0	8.0	10.0	12.0	14.0	16.0	18.0	20.0	22.0	25.0
P	1	Non-alloy steel	0.5D	1.5D	Vc	55	60	60	60	60	60	60	60	60	60
					fz	0.021	0.03	0.055	0.065	0.059	0.069	0.066	0.074	0.08	0.088
					RPM	2918	2387	1910	1592	1364	1194	1061	955	868	764
	FEED		245	286	420	414	402	412	420	424	417	403			
	2		Vc	40	50	45	45	45	50	50	50	45	45		
			fz	0.02	0.03	0.053	0.069	0.063	0.069	0.062	0.072	0.085	0.088		
			RPM	2122	1989	1432	1194	1023	995	884	796	651	573		
	FEED		170	239	304	329	322	343	329	344	332	303			
	3-4		Vc	30	35	35	35	35	35	35	35	30	35		
			fz	0.018	0.029	0.046	0.064	0.061	0.07	0.063	0.072	0.082	0.087		
RPM		1592	1393	1114	928	796	619	557	434	446					
FEED	115	162	205	238	243	244	234	241	214	233					
5	Vc	25	25	30	30	30	30	30	30	30	30				
	fz	0.02	0.03	0.045	0.061	0.057	0.065	0.061	0.068	0.075	0.083				
	RPM	1326	995	955	796	682	597	531	477	434	382				
FEED	106	119	172	194	194	194	194	195	195	190					
6	Vc	40	50	45	45	45	50	50	50	45	45				
	fz	0.02	0.03	0.053	0.069	0.063	0.069	0.062	0.072	0.085	0.088				
	RPM	2122	1989	1432	1194	1023	995	884	796	651	573				
FEED	170	239	304	329	322	343	329	344	332	303					
7	Vc	30	35	35	35	35	35	35	35	30	35				
	fz	0.018	0.029	0.046	0.064	0.061	0.07	0.063	0.072	0.082	0.087				
	RPM	1592	1393	1114	928	796	619	557	434	446					
FEED	115	162	205	238	243	244	234	241	214	233					
8-9	Vc	25	25	30	30	30	30	30	30	30	30				
	fz	0.02	0.03	0.045	0.061	0.057	0.065	0.061	0.068	0.075	0.083				
	RPM	1326	995	955	796	682	597	531	477	434	382				
FEED	106	119	172	194	194	194	194	195	195	190					
10	Vc	40	50	45	45	45	50	50	50	45	45				
	fz	0.02	0.03	0.053	0.069	0.063	0.069	0.062	0.072	0.085	0.088				
	RPM	2122	1989	1432	1194	1023	995	884	796	651	573				
FEED	170	239	304	329	322	343	329	344	332	303					
11.1	Vc	25	25	30	30	30	30	30	30	30	30				
	fz	0.02	0.03	0.045	0.061	0.057	0.065	0.061	0.068	0.075	0.083				
	RPM	1326	995	955	796	682	597	531	477	434	382				
FEED	106	119	172	194	194	194	194	195	195	190					
M	14.1	Stainless steel	0.5D	1.5D	Vc	25	30	30	30	30	30	30	30	30	
					fz	0.019	0.029	0.045	0.064	0.059	0.068	0.062	0.071	0.079	0.085
					RPM	1326	1194	955	796	682	597	531	477	434	382
FEED	101	138	172	204	201	203	197	203	206	195					
K	15-20	Grey cast iron Nodular cast iron Malleable cast iron	0.5D	1.5D	Vc	40	50	45	45	45	50	50	50	45	45
					fz	0.02	0.03	0.053	0.069	0.063	0.069	0.062	0.072	0.085	0.088
					RPM	2122	1989	1432	1194	1023	995	884	796	651	573
FEED	170	239	304	329	322	343	329	344	332	303					

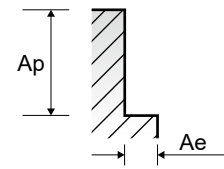

E9A26 SERIES

MULTI FLUTE ROUGHING - SIDE CUTTING

Vc = m/min.
fz = mm/tooth
RPM = rev./min.
FEED = mm/min.

ISO	VDI 3323	Material Description	Ae	Ap	Parameter	Diameter (Ø)									
						6.0	8.0	10.0	12.0	14.0	16.0	18.0	20.0	22.0	25.0
P	1	Non-alloy steel	0.5D	1.5D	Vc	35	40	40	40	40	40	40	40	40	40
					fz	0.018	0.028	0.05	0.059	0.056	0.063	0.061	0.067	0.072	0.08
					RPM	1857	1592	1273	1061	909	796	707	637	579	509
	FEED		134	178	255	250	255	251	259	256	250	244			
	2		0.5D	1.5D	Vc	30	35	30	30	30	30	35	30	30	30
					fz	0.018	0.027	0.049	0.063	0.058	0.064	0.056	0.067	0.078	0.081
					RPM	1592	1393	955	796	682	597	619	477	434	382
	FEED		115	150	187	201	198	191	208	192	203	186			
	3-4		0.5D	1.5D	Vc	20	25	20	25	20	25	25	25	20	20
					fz	0.017	0.028	0.044	0.058	0.055	0.062	0.057	0.065	0.073	0.08
					RPM	1061	995	637	663	455	497	442	398	289	255
FEED	72	111	112	154	125	154	151	155	127	122					
5	0.5D	1.5D	Vc	15	20	20	20	20	20	20	20	20	20		
			fz	0.018	0.027	0.042	0.055	0.051	0.059	0.056	0.061	0.068	0.076		
			RPM	796	796	637	531	455	398	354	318	289	255		
FEED	57	86	107	117	116	117	119	117	118	116					
6	0.5D	1.5D	Vc	30	35	30	30	30	30	35	30	30	30		
			fz	0.018	0.027	0.049	0.063	0.058	0.064	0.056	0.067	0.078	0.081		
			RPM	1592	1393	955	796	682	597	619	477	434	382		
FEED	115	150	187	201	198	191	208	192	203	186					
7	0.5D	1.5D	Vc	20	25	20	25	20	25	25	25	20	20		
			fz	0.017	0.028	0.044	0.058	0.055	0.062	0.057	0.065	0.073	0.08		
			RPM	1061	995	637	663	455	497	442	398	289	255		
FEED	72	111	112	154	125	154	151	155	127	122					
8-9	0.5D	1.5D	Vc	15	20	20	20	20	20	20	20	20	20		
			fz	0.018	0.027	0.042	0.055	0.051	0.059	0.056	0.061	0.068	0.076		
			RPM	796	796	637	531	455	398	354	318	289	255		
FEED	57	86	107	117	116	117	119	117	118	116					
10	0.5D	1.5D	Vc	30	35	30	30	30	30	35	30	30	30		
			fz	0.018	0.027	0.049	0.063	0.058	0.064	0.056	0.067	0.078	0.081		
			RPM	1592	1393	955	796	682	597	619	477	434	382		
FEED	115	150	187	201	198	191	208	192	203	186					
11.1	0.5D	1.5D	Vc	15	20	20	20	20	20	20	20	20	20		
			fz	0.018	0.027	0.042	0.055	0.051	0.059	0.056	0.061	0.068	0.076		
			RPM	796	796	637	531	455	398	354	318	289	255		
FEED	57	86	107	117	116	117	119	117	118	116					
M	14.1	Stainless steel	0.5D	1.5D	Vc	20	20	20	20	20	20	20	20	20	20
					fz	0.02	0.03	0.045	0.065	0.06	0.069	0.064	0.073	0.081	0.086
					RPM	1061	796	637	531	455	398	354	318	289	255
FEED	85	95	115	138	136	137	136	139	141	131					
K	15-20	Grey cast iron Nodular cast iron Malleable cast iron	0.5D	1.5D	Vc	30	35	30	30	30	30	35	30	30	30
					fz	0.018	0.027	0.049	0.063	0.058	0.064	0.056	0.067	0.078	0.081
					RPM	1592	1393	955	796	682	597	619	477	434	382
FEED	115	150	187	201	198	191	208	192	203	186					

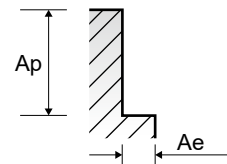

E9E43 SERIES

MULTI FLUTE ROUGHING - SIDE CUTTING

Vc = m/min.
fz = mm/tooth
RPM = rev./min.
FEED = mm/min.

ISO	VDI 3323	Material Description	Ae	Ap	Parameter	10.0	12.0	16.0	20.0	25.0	
P	1	Non-alloy steel	0.5D	1.5D	Vc	41	41	41	41	41	
					fz	0.042	0.05	0.067	0.085	0.081	
					RPM	1305	1088	816	653	522	
	FEED		219	218	219	222	211				
	2		0.5D	1.5D	Vc	32	32	32	32	32	
					fz	0.041	0.053	0.068	0.086	0.083	
					RPM	1019	849	637	509	407	
	FEED		167	180	173	175	169				
	3-4		0.5D	1.5D	Vc	23	23	23	23	23	
					fz	0.037	0.05	0.067	0.083	0.082	
					RPM	732	610	458	366	293	
FEED	108	122	123	122	120						
5	0.5D	1.5D	Vc	19	19	19	19	19			
			fz	0.035	0.048	0.064	0.079	0.079			
			RPM	605	504	378	302	242			
FEED	85	97	97	96	96						
6	0.5D	Low alloy steel	1.5D	Vc	32	32	32	32	32		
				fz	0.041	0.053	0.068	0.086	0.083		
				RPM	1019	849	637	509	407		
FEED	167		180	173	175	169					
7	0.5D		1.5D	Vc	23	23	23	23	23		
				fz	0.037	0.05	0.067	0.083	0.082		
				RPM	732	610	458	366	293		
FEED	108		122	123	122	120					
8	0.5D		1.5D	Vc	19	19	19	19	19		
				fz	0.035	0.048	0.064	0.079	0.079		
				RPM	605	504	378	302	242		
FEED	85	97	97	96	96						
9	0.5D	1.5D	Vc	19	19	19	19	19			
			fz	0.035	0.048	0.064	0.079	0.079			
			RPM	605	504	378	302	242			
FEED	64	97	97	119	96						
10	0.5D	High alloyed steel, and tool steel	1.5D	Vc	32	32	32	32	32		
				fz	0.041	0.053	0.068	0.086	0.083		
				RPM	1019	849	637	509	407		
FEED	167		180	173	175	169					
11.1	0.5D		1.5D	Vc	19	19	19	19	19		
				fz	0.035	0.048	0.064	0.079	0.079		
				RPM	605	504	378	302	242		
FEED	85		97	97	96	96					
M	14.1		Stainless steel	0.5D	1.5D	Vc	21	21	21	21	21
						fz	0.038	0.058	0.074	0.095	0.089
						RPM	668	557	418	334	267
FEED	102	129	124	127	119						
K	15-20	Grey cast iron Nodular cast iron Malleable cast iron	0.5D	1.5D	Vc	32	32	32	32	32	
					fz	0.041	0.053	0.068	0.086	0.083	
					RPM	1019	849	637	509	407	
FEED	167	180	173	175	169						

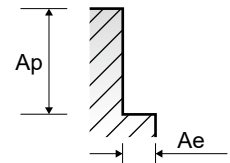

GAE43 SERIES

MULTI FLUTE ROUGHING - SIDE CUTTING

Vc = m/min.
fz = mm/tooth
RPM = rev./min.
FEED = mm/min.

ISO	VDI 3323	Material Description	Ae	Ap	Parameter	10.0	12.0	16.0	20.0	25.0	
P	1	Non-alloy steel	0.5D	1.5D	Vc	60	60	60	60	60	
					fz	0.047	0.055	0.074	0.094	0.09	
					RPM	1910	1592	1194	955	764	
					FEED	359	350	353	359	344	
	2		0.5D	1.5D	Vc	47	47	47	47	47	
					fz	0.045	0.058	0.074	0.092	0.09	
					RPM	1496	1247	935	748	598	
					FEED	269	289	277	275	269	
	3-4		0.5D	1.5D	Vc	33	33	33	33	33	
					fz	0.039	0.054	0.074	0.092	0.088	
RPM		1050			875	657	525	420			
FEED		164			189	194	193	185			
5	0.5D	1.5D	Vc	28	28	28	28	28			
			fz	0.038	0.052	0.07	0.088	0.086			
			RPM	891	743	557	446	357			
			FEED	135	154	156	157	153			
6	0.5D	Low alloy steel	1.5D	Vc	47	47	47	47	47		
				fz	0.045	0.058	0.074	0.092	0.09		
				RPM	1496	1247	935	748	598		
				FEED	269	289	277	275	269		
7	0.5D		1.5D	Vc	33	33	33	33	33		
				fz	0.039	0.054	0.074	0.092	0.088		
				RPM	1050	875	657	525	420		
				FEED	164	189	194	193	185		
8-9	0.5D		1.5D	Vc	28	28	28	28	28		
				fz	0.038	0.052	0.07	0.088	0.086		
		RPM		891	743	557	446	357			
		FEED		135	154	156	157	153			
10	0.5D	High alloyed steel, and tool steel	1.5D	Vc	47	47	47	47	47		
				fz	0.045	0.058	0.074	0.092	0.09		
				RPM	1496	1247	935	748	598		
				FEED	269	289	277	275	269		
11.1	0.5D		1.5D	Vc	28	28	28	28	28		
				fz	0.038	0.052	0.07	0.088	0.086		
				RPM	891	743	557	446	357		
				FEED	135	154	156	157	153		
M	14.1		Stainless steel	0.5D	1.5D	Vc	30	30	30	30	30
						fz	0.038	0.055	0.073	0.091	0.087
		RPM				955	796	597	477	382	
		FEED				145	175	174	174	166	
K	15-20	Grey cast iron Nodular cast iron Malleable cast iron	0.5D	1.5D	Vc	47	47	47	47	47	
					fz	0.045	0.058	0.074	0.092	0.09	
					RPM	1496	1247	935	748	598	
					FEED	269	289	277	275	269	

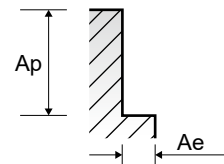



Global Cutting Tool Leader **YG-1**



MILLING



Leading Through Innovation



HSS

GENERAL HSS END MILLS HSS SCHAFTFRÄSER

- General Purpose / Coating Available
- Allgemeine Anwendung / Beschichtung verfügbar

SELECTION GUIDE



MILLING TOOLS

SERIES	E9410	E9720	E3570	E3574
FLUTE	2	Muti Flute	2	4
HELIX ANGLE	≈ 30°	30°	≈ 30°	≈ 30°
CUTTING EDGE SHAPE	SQUARE	SQUARE	SQUARE	SQUARE
SIZE MIN	D3.0	D6.0	D2.5	D2.0
SIZE MAX	D25.0	D30.0	D18.0	D18.0
PAGE	678	679	680	681

CBN
END MILLS

i-Xmill
END MILLS

i-SMART
MODULAR
END MILLS

X5070
END MILLS

4G MILL
END MILLS

X-POWER
PRO
END MILLS

TitaNox-
POWER
END MILLS

JET-POWER
END MILLS

V7 PLUS
END MILLS

ALU-POWER
HPC
END MILLS

ALU-
POWER
END MILLS

D-POWER
GRAPHITE
END MILLS

D-POWER
CFRP
END MILLS

ROUTERS

CRX S
END MILLS

K-2
END MILLS

ONLY ONE
COATED PM60
END MILLS

TANK-
POWER
END MILLS

GENERAL
HSS
END MILLS

MILLING
CUTTERS

TECHNICAL
DATA

HSS
GENERAL HSS
END MILLS

General Purpose, Non-coated, Any Coating Available



Please visit
globalyg1.com/mat
for material search

◎ : Excellent ○ : Good

Recommended cutting conditions : P 738

SHORT LENGTH	SHORT LENGTH ROUGHING	SHORT LENGTH	SHORT LENGTH
Uncoated / TiAIN	Uncoated / TiAIN	Uncoated / TiAIN	Uncoated
HSS-PM	HSS-PM	HSS-PM	HSS-PM

ISO	VDI 3323	Material Description	Composition / Structure / Heat Treatment	HB	HRc	◎	◎	◎	◎
P	1	Non-alloy steel	About 0.15% C Annealed	125		◎	◎	◎	◎
	2		About 0.45% C Annealed	190	13	◎	◎	◎	◎
	3		About 0.45% C Quenched & Tempered	250	25	◎	◎	◎	◎
	4		About 0.75% C Annealed	270	28	◎	◎	◎	◎
	5		About 0.75% C Quenched & Tempered	300	32	○	○	○	○
	6	Low alloy steel	Annealed	180	10	◎	◎	◎	◎
	7		Quenched & Tempered	275	29	◎	◎	◎	◎
	8		Quenched & Tempered	300	32	○	○	○	○
	9		Quenched & Tempered	350	38	○	○	○	○
	10		High alloyed steel, and tool steel	Annealed	200	15	◎	◎	◎
	11	Quenched & Tempered		325	35	○	○	○	○
M	12	Stainless steel	Ferritic / Martensitic Annealed	200	15				
	13		Martensitic Quenched & Tempered	240	23				
	14		Austenitic	180	10				
K	15	Grey cast iron	Pearlitic / ferritic	180	10				
	16		Pearlitic (Martensitic)	260	26				
	17	Nodular cast iron	Ferritic	160	3				
	18		Pearlitic	250	25				
	19		Ferritic	130					
20	Malleable cast iron	Pearlitic	230	21					
N	21	Aluminum-wrought alloy	Not Curable	60		○	○	○	○
	22		Curable Hardened	100		○	○	○	○
	23	Aluminum-cast, alloyed	≤ 12% Si, Not Curable	75		○	○	○	○
	24		≤ 12% Si, Curable Hardened	90		○	○	○	○
	25		> 12% Si, Not Curable	130		○	○	○	○
	26		Copper and Copper Alloys (Bronze / Brass)	Cutting Alloys, PB>1%	110				
	27	Non Metallic Materials	CuZn, CuSnZn (Brass)	90					
	28		CuSn, lead-free copper and electrolytic copper	100					
	29		Duroplastic, Fiber Reinforced Plastic						
	30	Rubber, Wood, etc.							
S	31	Heat Resistant Super Alloys	Fe Based Annealed	200	15				
	32		Fe Based Cured	280	30				
	33		Ni or Co Based Annealed	250	25				
	34		Ni or Co Based Cured	350	38				
	35	Titanium Alloys	Cast	320	34				
	36	Titanium Alloys	Pure Titanium	400 Rm					
	37		Alpha + Beta Alloys Hardened	1050 Rm					
H	38	Hardened steel	Hardened	550	55				
	39		Hardened	630	60				
	40	Chilled Cast Iron	Cast	400	42				
	41	Hardened Cast Iron	Hardened	550	55				

SELECTION GUIDE



HSS

SERIES	E2464	E2509	E2572	E2573	E2516	E2553	E2SET553
FLUTE	2	2	3	3	3	3	3
HELIX ANGLE	42°	42°	≈ 30°	≈ 30°	30°	30°	30°
SIZE MIN	D1.0	D2.0	D1.5	D1.0	D2.0	D1.0	D2.0
SIZE MAX	D32.0	D20.0	D32.0	D40.0	D40.0	D20.0	D10.0
PAGE	696	698	699	700	702	704	705

MILLING TOOLS

HSS GENERAL HSS END MILLS

General Purpose, Non-coated, Any Coating Available

◎ : Excellent ○ : Good

Recommended cutting conditions : P 738

Please visit globalyg1.com/mat for material search



SHORT LENGTH	LONG LENGTH	STUB LENGTH	SHORT LENGTH	LONG LENGTH	SHORT LENGTH THROW AWAY	THROW AWAY SET
Uncoated	Uncoated	Uncoated / TiAIN	Uncoated / TiAIN	Uncoated / TiAIN	Uncoated / TiAIN	Uncoated
HSS Co8	HSS Co8	HSS Co8	HSS Co8	HSS Co8	HSS Co8	HSS Co8



ISO	VDI 3323	Material Description	HB	HRc	E2464	E2509	E2572	E2573	E2516	E2553	E2SET553	
P	1	Non-alloy steel	125		○	○	◎	◎	◎	◎	◎	
	2		190	13	○	○	◎	◎	◎	◎	◎	
	3		250	25			◎	◎	◎	◎	◎	
	4		270	28			◎	◎	◎	◎	◎	
	5		300	32			◎	◎	◎	◎	◎	
	6	Low alloy steel	180	10	○	○	◎	◎	◎	◎	◎	
	7		275	29			◎	◎	◎	◎	◎	
	8		300	32			◎	◎	◎	◎	◎	
	9		350	38			○	○	○	○	○	
	10		High alloyed steel, and tool steel	200	15	○	○	◎	◎	◎	◎	◎
	11			325	35			○	○	○	○	○
M	12	Stainless steel	200	15								
	13		240	23								
	14		180	10								
K	15	Grey cast iron	180	10								
	16		260	26								
	17	Nodular cast iron	160	3								
	18		250	25								
	19		130									
20	Malleable cast iron	230	21									
N	21	Aluminum-wrought alloy	60		◎	◎	○	○	○	○	○	
	22		100		◎	◎	○	○	○	○	○	
	23	Aluminum-cast, alloyed	75		◎	◎	○	○	○	○	○	
	24		90		◎	◎	○	○	○	○	○	
	25		130		○	○	○	○	○	○	○	
	26		110									
	27	Copper and Copper Alloys (Bronze / Brass)	90									
	28		100									
	29	Non Metallic Materials										
	30											
S	31	Heat Resistant Super Alloys	200	15								
	32		280	30								
	33		250	25								
	34		350	38								
	35		320	34								
	36	Titanium Alloys	400 Rm									
	37		1050 Rm									
H	38	Hardened steel	550	55								
	39		630	60								
	40	Chilled Cast Iron	400	42								
	41	Hardened Cast Iron	550	55								

SELECTION GUIDE



HSS

SERIES	E2524	E2753	E2762	E2757	E2764	E2765	E2755
FLUTE	3&4	Multi Flute	Multi Flute	3&4	3	3	3
HELIX ANGLE	30°	30°	30°	30°	30°	30°	37°
	SQUARE ROUGHING	SQUARE ROUGHING	SQUARE ROUGHING	BALL NOSE ROUGHING	SQUARE ROUGHING	SQUARE ROUGHING	SQUARE ROUGHING
SIZE MIN	D6.0	D6.0	D6.0	R4.0	D10.0	D10.0	D6.0
SIZE MAX	D20.0	D40.0	D40.0	R12.5	D40.0	D40.0	D30.0
PAGE	719	720	721	722	723	724	725

MILLING TOOLS

HSS GENERAL HSS END MILLS

General Purpose, Non-coated, Any Coating Available

◎ : Excellent ○ : Good

Recommended cutting conditions : P 738

Please visit globalyg1.com/mat for material search



STUB LENGTH	SHORT LENGTH	LONG LENGTH	SHORT LENGTH	SHORT LENGTH	LONG LENGTH	SHORT LENGTH
Uncoated / TiAlN	Uncoated / TiAlN	Uncoated / TiAlN	Uncoated / TiAlN	Uncoated / TiAlN	Uncoated / TiAlN	Uncoated
HSS Co8	HSS Co8	HSS Co8	HSS Co8	HSS Co8	HSS Co8	HSS Co8



ISO	VDI 3323	Material Description	HB	HRc	E2524	E2753	E2762	E2757	E2764	E2765	E2755
P	1	Non-alloy steel	125		◎	◎	◎	◎	◎	◎	◎
	2		190	13	◎	◎	◎	◎	◎	◎	◎
	3		250	25	◎	◎	◎	◎	◎	◎	○
	4		270	28	◎	◎	◎	◎	◎	◎	○
	5	300	32	◎	◎	◎	◎	◎	◎	○	
	6	Low alloy steel	180	10	◎	◎	◎	◎	◎	◎	◎
	7		275	29	◎	◎	◎	◎	◎	◎	○
	8		300	32	◎	◎	◎	◎	◎	◎	○
	9	High alloyed steel, and tool steel	350	38	○	○	○	○	○	○	○
	10		200	15	◎	◎	◎	◎	◎	◎	◎
	11		325	35	○	○	○	○	○	○	○
M	12	Stainless steel	200	15							
	13		240	23							
D-POWER GRAPHITE END MILLS	14		180	10							
	15	Grey cast iron	180	10							
16	260		26								
D-POWER CFRP END MILLS	17	Nodular cast iron	160	3							
	18		250	25							
	19	Malleable cast iron	130								
	20		230	21							
ROUTERS	21	Aluminum-wrought alloy	60		○	○	○	○	○	○	◎
	22		100		○	○	○	○	○	○	◎
	23	Aluminum-cast, alloyed	75		○	○	○	○	○	○	◎
	24		90		○	○	○	○	○	○	◎
	25		130		○	○	○	○	○	○	○
	26	Copper and Copper Alloys (Bronze / Brass)	110								
	27		90								
	28	100									
	29	Non Metallic Materials									
30											
ONLY ONE COATED PM60 END MILLS	31	Heat Resistant Super Alloys	200	15							
	32		280	30							
	33		250	25							
	34		350	38							
	35		320	34							
	36	Titanium Alloys	400 Rm								
37	1050 Rm										
GENERAL HSS END MILLS	38	Hardened steel	550	55							
	39		630	60							
	40	Chilled Cast Iron	400	42							
	41	Hardened Cast Iron	550	55							



FLAT SHANK

E9410 SERIES

FLAT SHANK

EP410 SERIES

HSS-PM, 2 FLUTE SHORT LENGTH

- HSS-PM, 2 SCHNEIDEN KURZ
- Fraise HSS-PM, 2 dents, courte
- HSS-PM, 2 TAGLIENTI, SERIE CORTA



P.738

Unit : mm

EDP No.	Mill Diameter	Shank Diameter	Length of Cut	Overall Length	
					UNCOATED
▲ E9410030	▲ EP410030	3.0	6	5	49
-	▲ EP410040	4.0	6	7	51
-	▲ EP410050	5.0	6	8	52
-	▲ EP410060	6.0	6	8	52
-	▲ EP410080	8.0	10	11	61
▲ E9410100	▲ EP410100	10.0	10	13	63
▲ E9410120	-	12.0	12	16	73
-	▲ EP410140	14.0	12	16	73
▲ E9410160	▲ EP410160	16.0	16	19	79
▲ E9410180	-	18.0	16	19	79
▲ E9410250	-	25.0	25	26	102

▲ : Only available till stock runs out

- ▶Other shank design on your request.
- ▶TiN and TiCN Coatings are available on your request.

Tolerances according to DIN 7160 & 7161

	Tolerance range in μm					
	Nominal-Diameter in mm					
	from 1 to 3	over 3 to 6	over 6 to 10	over 10 to 18	over 18 to 30	over 30 to 50
e8	-14 -28	-20 -38	-25 -47	-32 -59	-40 -73	-50 -89
h6	0 -6	0 -8	0 -9	0 -11	0 -13	0 -16

◎ : Excellent ○ : Good

ISO	P											M			K					
	Non-alloy steel					Low alloy steel				High alloyed steel, and tool steel		Stainless steel			Grey cast iron		Nodular cast iron	Malleable cast iron		
Material Description	1	2	3	4	5	6	7	8	9	10	11	12	13	14	15	16	17	18	19	20
VDI 3323	1	2	3	4	5	6	7	8	9	10	11	12	13	14	15	16	17	18	19	20
HRc	13	25	28	32	36	40	45	50	55	60	65	70	75	80	85	90	95	100	105	110
HB	125	190	250	270	300	180	275	300	350	200	325	200	240	180	180	260	160	250	130	230
Recommend	◎	◎	◎	◎	◎	◎	◎	◎	◎	◎	◎	◎	◎	◎	◎	◎	◎	◎	◎	◎

ISO	N										S					H					
	Aluminum-wrought alloy		Aluminum-cast, alloyed			Copper and Copper Alloys (Bronze / Brass)		Non Metallic Materials			Heat Resistant Super Alloys					Titanium Alloys		Hardened steel	Chilled Cast Iron	Hardened Cast Iron	
Material Description	21	22	23	24	25	26	27	28	29	30	31	32	33	34	35	36	37	38	39	40	41
VDI 3323	21	22	23	24	25	26	27	28	29	30	31	32	33	34	35	36	37	38	39	40	41
HRc	60	100	75	90	130	110	90	100			15	30	25	38	34			55	60	42	55
HB	60	100	75	90	130	110	90	100			200	280	250	350	320	400 Rm	1050 Rm	550	630	400	550
Recommend	◎	◎	◎	◎	◎	◎	◎	◎	◎	◎	◎	◎	◎	◎	◎	◎	◎	◎	◎	◎	◎

HSS-PM, MULTI FLUTE SHORT LENGTH ROUGHING - FINE

- HSS-PM, MULTI SCHNEIDEN KURZ SCHRUPPFRÄSER - FEIN
- Fraise HSS-PM, multi-dents ébauche, pas fin, courte
- HSS-PM, MULTITAGLIENTE, SERIE CORTA, PER SGROSSAATURA, BOMBATO FINE

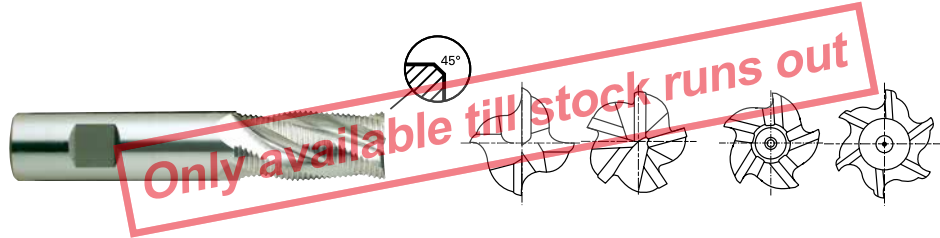

Unit : mm

EDP No.		Mill Diameter	Shank Diameter	Length of Cut	Overall Length	No. of Flute	Chamfer
UNCOATED	TiAIN	js12	h6				
▲ E9720060	▲ EP720060	6.0	6	13	57	4	0.18
▲ E9720090	-	9.0	10	19	69	5	0.18
▲ E9720100	▲ EP720100	10.0	10	22	72	5	0.18
▲ E9720110	▲ EP720110	11.0	12	22	79	5	0.18
▲ E9720120	▲ EP720120	12.0	12	26	83	5	0.18
▲ E9720130	▲ EP720130	13.0	12	26	83	5	0.18
▲ E9720140	▲ EP720140	14.0	12	26	83	5	0.25
-	▲ EP720150	15.0	12	26	83	5	0.25
▲ E9720160	▲ EP720160	16.0	16	32	92	5	0.25
-	▲ EP720180	18.0	16	32	92	5	0.25
▲ E9720200	-	20.0	20	38	104	5	0.25
▲ E9720220	▲ EP720220	22.0	20	38	104	5	0.30
-	▲ EP720250	25.0	25	45	121	6	0.36
▲ E9720300	▲ EP720300	30.0	25	45	121	6	0.33

- ▲ : Only available till stock runs out
- ▶ Other shank design on your request.
- ▶ TiN and TiCN Coatings are available on your request.

Tolerances according to DIN 7160 & 7161

Tolerance range in μm						
Nominal-Diameter in mm						
	from 1 to 3	over 3 to 6	over 6 to 10	over 10 to 18	over 18 to 30	over 30 to 50
js12	± 50	± 60	± 75	± 90	± 105	± 125
h6	0 -6	0 -8	0 -9	0 -11	0 -13	0 -16

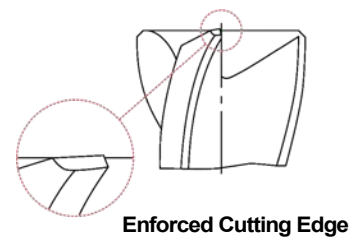

ISO Material Description	P										M			K							
	Non-alloy steel					Low alloy steel					High alloyed steel, and tool steel			Stainless steel			Grey cast iron		Nodular cast iron		Malleable cast iron
VDI 3323	1	2	3	4	5	6	7	8	9	10	11	12	13	14	15	16	17	18	19	20	
HRC	125	130	190	250	270	180	275	300	350	200	325	200	240	180	180	260	160	250	130	230	
Recommend	◎	◎	◎	◎	○	◎	◎	○	○	◎	◎	◎	◎	◎	◎	◎	◎	◎	◎	◎	
ISO Material Description	N										S						H				
	Aluminum-wrought alloy		Aluminum-cast, alloyed			Copper and Copper Alloys (Bronze / Brass)			Non Metallic Materials		Heat Resistant Super Alloys						Titanium Alloys		Hardened steel	Chilled Cast Iron	Hardened Cast Iron
VDI 3323	21	22	23	24	25	26	27	28	29	30	31	32	33	34	35	36	37	38	39	40	41
HRC	60	100	75	90	130	110	90	100			15	30	25	38	34	40	60	55	60	42	55
HB	60	100	75	90	130	110	90	100			200	280	250	350	320	400 Rm	1050 Rm	550	630	400	550
Recommend	○	○	○	○	○																

◎ : Excellent ○ : Good



FLAT SHANK

E3570 SERIES

FLAT SHANK

ER570 SERIES

HSS-PM, 2 FLUTE SHORT LENGTH

- HSS-PM, 2 SCHNEIDEN KURZ
- Fraise HSS-PM, 2 dents, courte
- HSS-PM, 2 TAGLIENTI, SERIE CORTA



Unit : mm

EDP No.	Mill Diameter		Shank Diameter		Length of Cut	Overall Length
	UNCOATED	TiAIN	e8	h6		
▲ E3570025	-	-	2.5	6	5	49
-	▲ ER570030	-	3.0	6	5	49
▲ E3570040	-	-	4.0	6	7	51
▲ E3570050	▲ ER570050	-	5.0	6	8	52
▲ E3570060	▲ ER570060	-	6.0	6	8	52
▲ E3570070	-	-	7.0	10	10	60
▲ E3570080	▲ ER570080	-	8.0	10	11	61
▲ E3570090	-	-	9.0	10	11	61
▲ E3570100	-	-	10.0	10	13	63
▲ E3570110	-	-	11.0	12	13	70
▲ E3570120	▲ ER570120	-	12.0	12	16	73
▲ E3570130	-	-	13.0	12	16	73
▲ E3570140	-	-	14.0	12	16	73
▲ E3570150	-	-	15.0	12	16	73
▲ E3570160	▲ ER570160	-	16.0	16	19	79
-	▲ ER570170	-	17.0	16	19	79
-	▲ ER570180	-	18.0	16	19	79

▲ : Only available till stock runs out

- ▶ Other shank design on your request.
- ▶ TiN and TiCN Coatings are available on your request.

Tolerances according to DIN 7160 & 7161

	Tolerance range in μm					
	Nominal-Diameter in mm					
	from 1 to 3	over 3 to 6	over 6 to 10	over 10 to 18	over 18 to 30	over 30 to 50
e8	-14 -28	-20 -38	-25 -47	-32 -59	-40 -73	-50 -89
h6	0 -6	0 -8	0 -9	0 -11	0 -13	0 -16

◎ : Excellent ○ : Good

ISO Material Description	P											M			K						
	Non-alloy steel					Low alloy steel				High alloyed steel, and tool steel		Stainless steel			Grey cast iron		Nodular cast iron		Malleable cast iron		
VDI 3323	1	2	3	4	5	6	7	8	9	10	11	12	13	14	15	16	17	18	19	20	
HRc	13	25	28	32	10	29	32	38	15	35	15	23	10	10	26	3	25				
HB	125	190	250	270	300	180	275	300	350	200	325	200	240	180	180	260	160	250	130	230	
Recommend	◎	◎	◎	◎	◎	◎	◎	◎	◎	◎	◎	◎	◎	◎	◎	◎	◎	◎	◎	◎	
ISO Material Description	N										S					H					
	Aluminum-wrought alloy		Aluminum-cast, alloyed			Copper and Copper Alloys (Bronze / Brass)			Non Metallic Materials		Heat Resistant Super Alloys					Titanium Alloys		Hardened steel	Chilled Cast Iron	Hardened Cast Iron	
VDI 3323	21	22	23	24	25	26	27	28	29	30	31	32	33	34	35	36	37	38	39	40	41
HRc											15	30	25	38	34			55	60	42	55
HB	60	100	75	90	130	110	90	100			200	280	250	350	320	400 Rm	1050 Rm	550	630	400	550
Recommend	◎	◎	◎	◎	◎	◎	◎	◎	◎	◎	◎	◎	◎	◎	◎	◎	◎	◎	◎	◎	◎

HSS-PM, 4 FLUTE SHORT LENGTH

- HSS-PM, 4 SCHNEIDEN KURZ
- Fraise HSS-PM, 4 dents, courte
- HSS-PM, 4 TAGLIENTI, SERIE CORTA



HSS PM
DIN 844
4
30°
DIN 1835B
P.741

EDP No.	Mill Diameter	Shank Diameter	Length of Cut	Overall Length
Unit : mm				
UNCOATED				
▲ E3574020	2.0	6	7	51
▲ E3574030	3.0	6	8	52
▲ E3574040	4.0	6	11	55
▲ E3574050	5.0	6	13	57
▲ E3574060	6.0	6	13	57
▲ E3574090	9.0	10	19	69
▲ E3574100	10.0	10	22	72
▲ E3574120	12.0	12	26	83
▲ E3574140	14.0	12	26	83
▲ E3574180	18.0	16	32	92

- ▲ : Only available till stock runs out
- ▶ Other shank design on your request.
- ▶ TIN and TiCN Coatings are available on your request.

Mill Dia. Tolerance (mm)	Shank Dia. Tolerance
+ 0.04 - 0	h6

ISO Material Description	P										M			K							
	Non-alloy steel					Low alloy steel					High alloyed steel, and tool steel			Stainless steel			Grey cast iron		Nodular cast iron		Malleable cast iron
VDI 3323	1	2	3	4	5	6	7	8	9	10	11	12	13	14	15	16	17	18	19	20	
HRC	13	25	28	32	10	29	32	38	15	35	15	23	10	10	26	3	25	42	55		
HB	125	190	250	270	300	180	275	300	350	200	325	200	240	180	180	260	160	250	130	230	
Recommend	◎	◎	◎	◎	○	◎	◎	○	○	◎	○	○	○	○	○	○	○	○	○	○	○

ISO Material Description	N					S										H									
	Aluminum-wrought alloy		Aluminum-cast, alloyed			Copper and Copper Alloys (Bronze / Brass)			Non Metallic Materials		Heat Resistant Super Alloys					Titanium Alloys		Hardened steel	Chilled Cast Iron	Hardened Cast Iron					
VDI 3323	21	22	23	24	25	26	27	28	29	30	31	32	33	34	35	36	37	38	39	40	41				
HRC	60	100	75	90	130	110	90	100			15	30	25	38	34	200	280	250	350	400 Rm	1050 Rm	550	630	400	550
Recommend	○	○	○	○	○	○	○	○	○	○	○	○	○	○	○	○	○	○	○	○	○	○	○	○	○

◎ : Excellent ○ : Good

HSS-PM, 3 FLUTE 60° HELIX SHORT LENGTH

- HSS-PM, 3 SCHNEIDEN 60° RECHTSSPIRALE KURZ
- Fraise HSS-PM, 3 dents, hélice 60°, courte
- HSS-PM, 3 TAGLIENTI, ELICA 60°, SERIE CORTA



1 Tooth over center cut type

HSS PM
DIN 844
3
60°
DIN 1835B
P.741

Unit : mm

EDP No.	Mill Diameter	Shank Diameter	Length of Cut	Overall Length
UNCOATED				
▲ E3462070	7.0	10	16	66
▲ E3462080	8.0	10	19	69
▲ E3462090	9.0	10	19	69
▲ E3462100	10.0	10	22	72
▲ E3462120	12.0	12	26	83
▲ E3462140	14.0	12	26	83
▲ E3462150	15.0	12	26	83
▲ E3462160	16.0	16	32	92
▲ E3462180	18.0	16	32	92
▲ E3462200	20.0	20	38	104

- ▲ : Only available till stock runs out
- ▶ Other shank design on your request.
- ▶ TiN and TiCN Coatings are available on your request.

Mill Dia. Tolerance(mm)		Shank Dia. Tolerance
up to Ø6.5	+ 0.048 - 0	
Ø7.0 ~ Ø10.0	+ 0.058 - 0	
Ø10.5 ~ Ø18.0	+ 0.070 - 0	
over Ø18.0	+ 0.084 - 0	h6

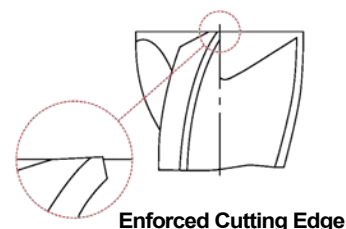

ISO Material Description	P											M			K					
	Non-alloy steel					Low alloy steel				High alloyed steel, and tool steel		Stainless steel			Grey cast iron		Nodular cast iron	Malleable cast iron		
VDI 3323	1	2	3	4	5	6	7	8	9	10	11	12	13	14	15	16	17	18	19	20
HRc	13	25	28	32	10	29	32	38	15	35	15	23	10	10	26	3	25		21	
HB	125	190	250	270	300	180	275	300	350	200	200	240	180	180	260	160	250	130	230	
Recommend	◎	◎	◎	◎	○	◎	◎	○	○	◎	○									

ISO Material Description	N										S							H			
	Aluminum-wrought alloy		Aluminum-cast, alloyed			Copper and Copper Alloys (Bronze / Brass)			Non Metallic Materials		Heat Resistant Super Alloys					Titanium Alloys		Hardened steel	Chilled Cast Iron	Hardened Cast Iron	
VDI 3323	21	22	23	24	25	26	27	28	29	30	31	32	33	34	35	36	37	38	39	40	41
HRc											15	30	25	38	34			55	60	42	55
HB	60	100	75	90	130	110	90	100			200	280	250	350	320	400 Rm	1050 Rm	550	630	400	550
Recommend	○	○	○	○	○																

◎ : Excellent ○ : Good

HSSCo8, 2 FLUTE SHORT LENGTH BALL NOSE

- HSSCo8, 2 SCHNEIDEN KURZ STIRNRADIUS
- Fraise HSSCo8, 2 dents, hémisphérique, courte
- 2 TAGLIANTI, SEMISFERICA, SERIE CORTA - HSSCo8



HSS Co8
DIN 327
2
30°
R ±0.02
DIN 1835B
P.742~743

Unit : mm

EDP No.		Radius of Ball Nose	Mill Diameter	Shank Diameter	Length of Cut	Overall Length
UNCOATED	TiAIN	R (±0.02)		h6		
E2535020	EQ535020	R1.0	2.0	6	4	48
E2535025	EQ535025	R1.25	2.5	6	5	49
E2535030	EQ535030	R1.5	3.0	6	5	49
E2535035	EQ535035	R1.75	3.5	6	6	50
E2535040	EQ535040	R2.0	4.0	6	7	51
E2535045	EQ535045	R2.25	4.5	6	7	51
E2535050	EQ535050	R2.5	5.0	6	8	52
E2535055	EQ535055	R2.75	5.5	6	8	52
E2535060	EQ535060	R3.0	6.0	6	8	52
E2535070	EQ535070	R3.5	7.0	10	10	60
E2535080	EQ535080	R4.0	8.0	10	11	61
E2535090	EQ535090	R4.5	9.0	10	11	61
E2535100	EQ535100	R5.0	10.0	10	13	63
E2535110	EQ535110	R5.5	11.0	12	13	70
E2535120	EQ535120	R6.0	12.0	12	16	73
E2535130	EQ535130	R6.5	13.0	12	16	73
E2535140	EQ535140	R7.0	14.0	12	16	73
E2535150	EQ535150	R7.5	15.0	12	16	73
E2535160	EQ535160	R8.0	16.0	16	19	79
E2535170	EQ535170	R8.5	17.0	16	19	79
E2535180	EQ535180	R9.0	18.0	16	19	79
E2535190	EQ535190	R9.5	19.0	16	19	79
E2535923	EQ535923	R10.0	20.0	16	22	82
E2535200	EQ535200	R10.0	20.0	20	22	88
E2535220	EQ535220	R11.0	22.0	20	22	88
E2535922	EQ535922	R11.0	22.0	25	22	98
E2535240	EQ535240	R12.0	24.0	25	26	102
E2535250	EQ535250	R12.5	25.0	25	26	102
E2535260	EQ535260	R13.0	26.0	25	26	102
E2535280	EQ535280	R14.0	28.0	25	26	102
E2535300	EQ535300	R15.0	30.0	25	26	102
E2535320	EQ535320	R16.0	32.0	32	32	112

Mill Dia. Tolerance (mm)	Shank Dia. Tolerance
0 ~ - 0.03	h6

- ▶ Other shank design on your request.
- ▶ TiN and TiCN Coatings are available on your request.

◎ : Excellent ○ : Good

ISO Material Description	P										M			K						
	Non-alloy steel					Low alloy steel					High alloyed steel, and tool steel			Stainless steel			Grey cast iron		Nodular cast iron	Malleable cast iron
VDI 3323	1	2	3	4	5	6	7	8	9	10	11	12	13	14	15	16	17	18	19	20
HRC	13	25	28	32	10	29	32	38	15	35	15	23	10	10	26	3	25	25	21	
HB	125	190	250	270	300	180	275	300	350	200	325	200	240	180	180	260	160	250	130	230
Recommend	◎	◎	◎	◎	○	◎	◎	○	○	◎	○	◎	◎	◎	◎	◎	◎	◎	◎	◎

ISO Material Description	N					S										H					
	Aluminum-wrought alloy		Aluminum-cast, alloyed			Copper and Copper Alloys (Bronze / Brass)			Non Metallic Materials		Heat Resistant Super Alloys					Titanium Alloys		Hardened steel	Chilled Cast Iron	Hardened Cast Iron	
VDI 3323	21	22	23	24	25	26	27	28	29	30	31	32	33	34	35	36	37	38	39	40	41
HRC	15	30	25	38	34	15	30	25	38	34	200	280	250	350	320	400 Rm	1050 Rm	550	630	400	550
HB	60	100	75	90	130	110	90	100													
Recommend	○	○	○	○	○																



FLAT SHANK

E2492 SERIES

FLAT SHANK

EQ492 SERIES

HSSCo8, 2 FLUTE LONG LENGTH BALL NOSE

- HSSCo8, 2 SCHNEIDEN LANG STIRNRADIUS
- Fraise HSSCo8, 2 dents, hémisphérique, longue
- 2 TAGLIENTI, SEMISFERICA, SERIE LUNGA - HSSCo8



HSS Co8
DIN 1889
2
≈ 30°
R ±0.02
DIN 1835B
P.742~743

Unit : mm

EDP No.	Radius of Ball Nose	Mill Diameter	Shank Diameter	Length of Cut	Overall Length	
						UNCOATED
E2492020	EQ492020	R1.0	2.0	6	7	54
E2492030	EQ492030	R1.5	3.0	6	8	56
E2492040	EQ492040	R2.0	4.0	6	11	63
E2492050	EQ492050	R2.5	5.0	6	13	68
E2492060	EQ492060	R3.0	6.0	6	13	68
E2492070	EQ492070	R3.5	7.0	10	16	80
E2492080	EQ492080	R4.0	8.0	10	19	88
E2492090	EQ492090	R4.5	9.0	10	19	88
E2492100	EQ492100	R5.0	10.0	10	22	95
E2492110	EQ492110	R5.5	11.0	12	22	102
E2492120	EQ492120	R6.0	12.0	12	26	110
E2492130	EQ492130	R6.5	13.0	12	26	110
E2492140	EQ492140	R7.0	14.0	12	26	110
E2492150	EQ492150	R7.5	15.0	12	26	110
E2492160	EQ492160	R8.0	16.0	16	32	123
E2492170	EQ492170	R8.5	17.0	16	32	123
E2492180	EQ492180	R9.0	18.0	16	32	123
E2492190	EQ492190	R9.5	19.0	16	32	123
E2492200	EQ492200	R10.0	20.0	20	38	141
E2492220	EQ492220	R11.0	22.0	20	38	141
E2492240	EQ492240	R12.0	24.0	25	45	166
E2492250	EQ492250	R12.5	25.0	25	45	166
E2492260	EQ492260	R13.0	26.0	25	45	166
E2492280	EQ492280	R14.0	28.0	25	45	166
E2492300	EQ492300	R15.0	30.0	25	45	166

- ▶ Other shank design on your request.
- ▶ TiN and TiCN Coatings are available on your request.

Mill Dia. Tolerance (mm)	Shank Dia. Tolerance
0 ~ - 0.03	h6

◎ : Excellent ○ : Good

ISO Material Description	P											M			K					
	Non-alloy steel					Low alloy steel				High alloyed steel, and tool steel		Stainless steel			Grey cast iron		Nodular cast iron		Malleable cast iron	
VDI 3323	1	2	3	4	5	6	7	8	9	10	11	12	13	14	15	16	17	18	19	20
HRc		13	25	28	32	10	29	32	38	15	35	15	23	10	10	26	3	25		21
HB	125	190	250	270	300	180	275	300	350	200	325	200	240	180	180	260	160	250	130	230
Recommend	◎	◎	◎	◎	◎	◎	◎	◎	◎	◎	◎	◎	◎	◎	◎	◎	◎	◎	◎	◎

ISO Material Description	N					S					H										
	Aluminum-wrought alloy		Aluminum-cast, alloyed			Copper and Copper Alloys (Bronze / Brass)		Non Metallic Materials			Heat Resistant Super Alloys			Titanium Alloys		Hardened steel	Chilled Cast Iron	Hardened Cast Iron			
VDI 3323	21	22	23	24	25	26	27	28	29	30	31	32	33	34	35	36	37	38	39	40	41
HRc											15	30	25	38	34			55	60	42	55
HB	60	100	75	90	130	110	90	100			200	280	250	350	320	400 Rm	1050 Rm	550	630	400	550
Recommend	◎	◎	◎	◎	◎	◎	◎	◎	◎	◎	◎	◎	◎	◎	◎	◎	◎	◎	◎	◎	◎

HSSCo8, 3 FLUTE SHORT LENGTH BALL NOSE THROW AWAY

- HSSCo8, 3 SCHNEIDEN KURZ STIRNRADIUS EINWEGFRÄSER
- Ⓜ Fraise HSSCo8, 3 dents, hémisphérique à jeter, courte
- ③ 3 TAGLIENTI, SEMISFERICA, SERIE CORTA, NON RIAFFILABILE - HSSCo8



HSS Co8
YG STD
3
30°
R ±0.02
FLAT
P.744~745

Unit : mm

EDP No.		Radius of Ball Nose	Mill Diameter	Shank Diameter	Length of Cut	Overall Length
UNCOATED	TiAIN	R (±0.02)		h6		
▲ E2512020	▲ EQ512020	R1.0	2.0	6	4	35
▲ E2512025	▲ EQ512025	R1.25	2.5	6	5	36
▲ E2512030	▲ EQ512030	R1.5	3.0	6	5	36
▲ E2512040	▲ EQ512040	R2.0	4.0	6	7	38
▲ E2512050	▲ EQ512050	R2.5	5.0	6	8	39
▲ E2512060	▲ EQ512060	R3.0	6.0	6	8	39

▲ : Only available till stock runs out
 ►TiN and TiCN Coatings are available on your request.

Mill Dia. Tolerance (mm)	Shank Dia. Tolerance
0 ~ - 0.03	h6

◎ : Excellent ○ : Good

ISO Material Description	P										M			K							
	Non-alloy steel					Low alloy steel					High alloyed steel, and tool steel			Stainless steel			Grey cast iron		Nodular cast iron		Malleable cast iron
VDI 3323	1	2	3	4	5	6	7	8	9	10	11	12	13	14	15	16	17	18	19	20	
HRC	13	19	25	28	32	10	29	32	38	15	35	15	23	10	10	26	3	25	42	55	
HB	125	190	250	270	300	180	275	300	350	200	325	200	240	180	180	260	160	250	130	230	
Recommend	◎	◎	◎	◎	○	◎	◎	○	○	◎	○										

ISO Material Description	N					S										H					
	Aluminum-wrought alloy		Aluminum-cast, alloyed			Copper and Copper Alloys (Bronze / Brass)			Non Metallic Materials		Heat Resistant Super Alloys					Titanium Alloys		Hardened steel	Chilled Cast Iron	Hardened Cast Iron	
VDI 3323	21	22	23	24	25	26	27	28	29	30	31	32	33	34	35	36	37	38	39	40	41
HRC	60	100	75	90	130	110	90	100			15	30	25	38	34	400 Rm	1050 Rm	550	630	400	550
HB	60	100	75	90	130	110	90	100			200	280	250	350	320	400 Rm	1050 Rm	550	630	400	550
Recommend	○	○	○	○	○																



FLAT SHANK

E2410 SERIES

FLAT SHANK

EQ410 SERIES

HSSCo8, 4&6 FLUTE SHORT LENGTH BALL NOSE

- HSSCo8, 4&6 SCHNEIDEN KURZ STIRNRADIUS
- Fraise HSSCo8, 4&6 dents, hémisphérique, courte
- 4&6 TAGLIENTI, SEMISFERICA, SERIE CORTA - HSSCo8



HSS Co8
DIN 1889
4&6
30°
R ±0.02
DIN 1835B
P.744~745

Unit : mm

EDP No.	Radius of Ball Nose	Mill Diameter	Shank Diameter	Length of Cut	Overall Length	No. of Flute
▲ E2410060	▲ EQ410060	R3.0	6.0	6	13	4
▲ E2410080	▲ EQ410080	R4.0	8.0	10	19	4
▲ E2410100	▲ EQ410100	R5.0	10.0	10	22	4
▲ E2410120	-	R6.0	12.0	12	26	4
▲ E2410160	▲ EQ410160	R8.0	16.0	16	32	4
▲ E2410200	-	R10.0	20.0	20	38	4
▲ E2410250	-	R12.5	25.0	25	45	6

▲ : Only available till stock runs out

Mill Dia. Tolerance (mm)	Shank Dia. Tolerance
0 ~ - 0.03	h6

◎ : Excellent ○ : Good

ISO Material Description	P											M			K					
	Non-alloy steel					Low alloy steel				High alloyed steel, and tool steel		Stainless steel			Grey cast iron		Nodular cast iron	Malleable cast iron		
VDI 3323	1	2	3	4	5	6	7	8	9	10	11	12	13	14	15	16	17	18	19	20
HRc	13	25	28	32	10	29	32	38	15	35	15	23	10	10	26	3	25		21	
HB	125	190	250	270	300	180	275	300	350	200	325	200	240	180	180	260	160	250	130	230
Recommend	◎	◎	◎	◎	○	◎	◎	○	○	◎	○									

ISO Material Description	N										S							H			
	Aluminum-wrought alloy		Aluminum-cast, alloyed			Copper and Copper Alloys (Bronze / Brass)			Non Metallic Materials		Heat Resistant Super Alloys					Titanium Alloys		Hardened steel	Chilled Cast Iron	Hardened Cast Iron	
VDI 3323	21	22	23	24	25	26	27	28	29	30	31	32	33	34	35	36	37	38	39	40	41
HRc											15	30	25	38	34			55	60	42	55
HB	60	100	75	90	130	110	90	100			200	280	250	350	320	400 Rm	1050 Rm	550	630	400	550
Recommend	○	○	○	○	○																

HSSCo8, 4&6 FLUTE LONG LENGTH BALL NOSE

- HSSCo8, 4&6 SCHNEIDEN LANG STIRNRADIUS
- Fraise HSSCo8, 4&6 dents, hémisphérique, longue
- 4&6 TAGLIENTI, SEMISFERICA, SERIE LUNGA - HSSCo8



HSS Co8
DIN 1889
4&6
30°
R ±0.02
DIN 1835B
P.744~745

Unit : mm

EDP No.		Radius of Ball Nose	Mill Diameter	Shank Diameter	Length of Cut	Overall Length	No. of Flute
UNCOATED	TiAIN	R (±0.02)		h6			
▲ E2429100	-	R5.0	10.0	10	45	95	4
▲ E2429120	▲ EQ429120	R6.0	12.0	12	53	110	4
▲ E2429160	-	R8.0	16.0	16	63	123	4
▲ E2429200	-	R10.0	20.0	20	75	141	4
▲ E2429250	-	R12.5	25.0	25	90	166	6

▲ : Only available till stock runs out

Mill Dia. Tolerance (mm)	Shank Dia. Tolerance
0 ~ - 0.03	h6

◎ : Excellent ○ : Good

ISO Material Description	P										M			K						
	Non-alloy steel					Low alloy steel					High alloyed steel, and tool steel			Stainless steel			Grey cast iron	Nodular cast iron		Malleable cast iron
VDI 3323	1	2	3	4	5	6	7	8	9	10	11	12	13	14	15	16	17	18	19	20
HRC	13	25	28	32	10	29	32	38	15	35	15	23	10	180	260	160	250	130	230	
HB	125	190	250	270	300	180	275	300	350	200	325	200	240	180	180	260	160	250	130	230
Recommend	◎	◎	◎	◎	○	◎	◎	○	○	◎	○	◎	◎	◎	◎	◎	◎	◎	◎	◎

ISO Material Description	N					S										H					
	Aluminum-wrought alloy		Aluminum-cast, alloyed			Copper and Copper Alloys (Bronze / Brass)			Non Metallic Materials		Heat Resistant Super Alloys					Titanium Alloys		Hardened steel	Chilled Cast Iron	Hardened Cast Iron	
VDI 3323	21	22	23	24	25	26	27	28	29	30	31	32	33	34	35	36	37	38	39	40	41
HRC	60	100	75	90	130	110	90	100			15	30	25	38	34	400 Rm	1050 Rm	550	630	400	550
HB	60	100	75	90	130	110	90	100			200	280	250	350	320	400 Rm	1050 Rm	550	630	400	550
Recommend	○	○	○	○	○	○	○	○	○	○	○	○	○	○	○	○	○	○	○	○	○



HSS-E, 1 FLUTE

- HSS-E, 1 SCHNEIDEN
- Fraise HSS-E, 1 dent
- 1 TAGLIENTE - HSS-E



HSS-E
YG STD
1
≈ 30°
DIN 1835A
P.745

Unit : mm

EDP No.	Mill Diameter	Shank Diameter	Length of Cut	Overall Length
UNCOATED	js14	h6		
▲ EL623030	3.0	8	12	60
▲ EL623040	4.0	8	12	60
▲ EL623050	5.0	8	12	60
▲ EL623060	6.0	8	14	60
▲ EL623070	7.0	8	14	60
▲ EL623080	8.0	8	14	80
▲ EL623090	9.0	8	14	80
▲ EL623100	10.0	8	14	80

▲ : Only available till stock runs out

Tolerances according to DIN 7160 & 7161

	Tolerance range in μm					
	Nominal-Diameter in mm					
	from 1 to 3	over 3 to 6	over 6 to 10	over 10 to 18	over 18 to 30	over 30 to 50
js14	±125	±150	±180	±215	±260	±310
h6	0 -6	0 -8	0 -9	0 -11	0 -13	0 -16

◎ : Excellent ○ : Good

ISO	P											M				K					
	Non-alloy steel					Low alloy steel				High alloyed steel, and tool steel		Stainless steel		Grey cast iron		Nodular cast iron		Malleable cast iron			
Material Description	1	2	3	4	5	6	7	8	9	10	11	12	13	14	15	16	17	18	19	20	
VDI 3323																					
HRc																					
HB	125	190	250	270	300	180	275	300	350	200	325	200	240	180	180	260	160	250	130	230	
Recommend	○	○	○	○	○	○	○	○	○	○	○	○	○	○	○	○	○	○	○	○	
ISO	N										S							H			
	Aluminum-wrought alloy		Aluminum-cast, alloyed			Copper and Copper Alloys (Bronze / Brass)			Non Metallic Materials		Heat Resistant Super Alloys					Titanium Alloys		Hardened steel	Chilled Cast Iron	Hardened Cast Iron	
Material Description	21	22	23	24	25	26	27	28	29	30	31	32	33	34	35	36	37	38	39	40	41
VDI 3323																					
HRc																					
HB	60	100	75	90	130	110	90	100			200	280	250	350	320	400 Rm	1050 Rm	550	630	400	550
Recommend	○	○	○	○	○	○	○	○	○	○	○	○	○	○	○	○	○	○	○	○	○

HSS-E, 1 FLUTE for ALUMINIUM

- HSS-E, 1 SCHNEIDEN für ALUMINIUM
- Fraise HSS-E, 1 dent pour aluminium
- 1 TAGLIENTE - HSS-E

for ALUMINIUM
für ALUMINIUM

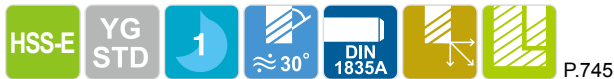
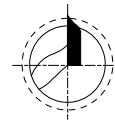

Unit : mm

EDP No.	Mill Diameter	Shank Diameter	Length of Cut	Overall Length
UNCOATED	js14	h6		
EL612030	3.0	8	12	60
EL612040	4.0	8	12	60
EL612050	5.0	8	12	60
EL612060	6.0	8	14	60
EL612070	7.0	8	14	60
EL612080	8.0	8	14	80
EL612090	9.0	8	14	80
EL612100	10.0	8	14	80

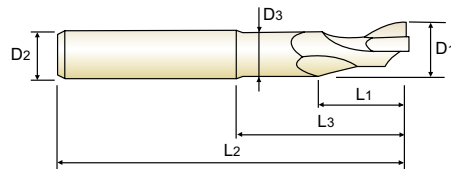
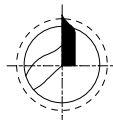

Unit : mm

EDP No.	Mill Diameter	Shank Diameter	Length of Cut	Length Below Shank	Overall Length	Neck Diameter
UNCOATED	D1(js14)	D2(h6)	L1	L3	L2	L2
EL612904	5.0	8	18	35	80	4.8
EL612909	5.0	8	40	-	100	-
EL612932	8.0	8	14	68	120	7.5

Tolerances according to DIN 7160 & 7161

Tolerance range in μm						
Nominal-Diameter in mm						
	from 1 to 3	over 3 to 6	over 6 to 10	over 10 to 18	over 18 to 30	over 30 to 50
js14	± 125	± 150	± 180	± 215	± 260	± 310
h6	0 -6	0 -8	0 -9	0 -11	0 -13	0 -16

◎ : Excellent ○ : Good

ISO Material Description	P										M			K							
	Non-alloy steel					Low alloy steel					High alloyed steel, and tool steel			Stainless steel			Grey cast iron		Nodular cast iron		Malleable cast iron
VDI 3323	1	2	3	4	5	6	7	8	9	10	11	12	13	14	15	16	17	18	19	20	
HRc		13	25	28	32	10	29	32	38	15	35	15	23	10	10	26	3	25		21	
HB	125	190	250	270	300	180	275	300	350	200	325	200	240	180	180	260	160	250	130	230	
Recommend	○	○				○				○											
ISO Material Description	N					S					H										
	Aluminum- wrought alloy		Aluminum-cast, alloyed			Copper and Copper Alloys (Bronze / Brass)		Non Metallic Materials			Heat Resistant Super Alloys			Titanium Alloys		Hardened steel	Chilled Cast Iron	Hardened Cast Iron			
VDI 3323	21	22	23	24	25	26	27	28	29	30	31	32	33	34	35	36	37	38	39	40	41
HRc											15	30	25	38	34			55	60	42	55
HB	60	100	75	90	130	110	90	100			200	280	250	350	320	400 Rm	1050 Rm	550	630	400	550
Recommend	◎	◎	◎	◎	○																

CBN
END MILLS

i-Xmill
END MILLS

i-SMART
MODULAR
END MILLS

X5070
END MILLS

4G MILL
END MILLS

X-POWER
PRO
END MILLS

TitaNox-
POWER
END MILLS

JET-POWER
END MILLS

V7 PLUS
END MILLS

ALU-POWER
HPC
END MILLS

ALU-
POWER
END MILLS

D-POWER
GRAPHITE
END MILLS

D-POWER
CFRP
END MILLS

ROUTERS

CRX S
END MILLS

K-2
END MILLS

ONLY ONE
COATED PM60
END MILLS

TANK-
POWER
END MILLS

GENERAL
HSS
END MILLS

MILLING
CUTTERS

TECHNICAL
DATA



FLAT SHANK

E2570 SERIES

FLAT SHANK

EQ570 SERIES

HSSCo8, 2 FLUTE SHORT LENGTH

- HSSCo8, 2 SCHNEIDEN KURZ**
- Fraise HSSCo8, 2 dents, courte**
- 2 TAGLIENTI, SERIE CORTA - HSSCo8**

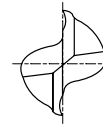

P.746~749

Unit : mm

EDP No.	Mill Diameter	Shank Diameter	Length of Cut	Overall Length	
					UNCOATED
E2570010	EQ570010	1.0	6	2.5	47
E2570015	EQ570015	1.5	6	3	47
E2570020	EQ570020	2.0	6	4	48
E2570025	EQ570025	2.5	6	5	49
E2570028	EQ570028	2.8	6	5	49
E2570030	EQ570030	3.0	6	5	49
E2570035	EQ570035	3.5	6	6	50
E2570038	EQ570038	3.8	6	7	51
E2570040	EQ570040	4.0	6	7	51
E2570045	EQ570045	4.5	6	7	51
E2570048	EQ570048	4.8	6	8	52
E2570050	EQ570050	5.0	6	8	52
E2570055	EQ570055	5.5	6	8	52
E2570957	EQ570957	5.8	6	8	52
E2570060	EQ570060	6.0	6	8	52
E2570065	EQ570065	6.5	10	10	60
E2570967	EQ570967	6.8	10	10	60
E2570070	EQ570070	7.0	10	10	60
E2570075	EQ570075	7.5	10	10	60
E2570977	EQ570977	7.8	10	11	61
E2570080	EQ570080	8.0	10	11	61
E2570085	EQ570085	8.5	10	11	61
E2570087	EQ570087	8.7	10	11	61
E2570090	EQ570090	9.0	10	11	61

Tolerances according to DIN 7160 & 7161

▶ Other shank design on your request.

▶ NEXT PAGE

▶ TiN and TiCN Coatings are available on your request.

	Tolerance range in μm					
	Nominal-Diameter in mm					
	from 1 to 3	over 3 to 6	over 6 to 10	over 10 to 18	over 18 to 30	over 30 to 50
e8	- 14 - 28	- 20 - 38	- 25 - 47	- 32 - 59	- 40 - 73	- 50 - 89
h6	0 - 6	0 - 8	0 - 9	0 - 11	0 - 13	0 - 16

◎ : Excellent ○ : Good

ISO Material Description	P											M			K						
	Non-alloy steel					Low alloy steel				High alloyed steel, and tool steel		Stainless steel			Grey cast iron		Nodular cast iron		Malleable cast iron		
VDI 3323	1	2	3	4	5	6	7	8	9	10	11	12	13	14	15	16	17	18	19	20	
HRc		13	25	28	32	10	29	32	38	15	35	15	23	10	10	26	3	25		21	
HB	125	190	250	270	300	180	275	300	350	200	325	200	240	180	180	260	160	250	130	230	
Recommend	◎	◎	◎	◎	◎	◎	◎	◎	◎	◎	◎	◎	◎	◎	◎	◎	◎	◎	◎	◎	
ISO Material Description	N										S					H					
	Aluminum-wrought alloy		Aluminum-cast, alloyed			Copper and Copper Alloys (Bronze / Brass)			Non Metallic Materials		Heat Resistant Super Alloys					Titanium Alloys		Hardened steel	Chilled Cast Iron	Hardened Cast Iron	
VDI 3323	21	22	23	24	25	26	27	28	29	30	31	32	33	34	35	36	37	38	39	40	41
HRc											15	30	25	38	34			55	60	42	55
HB	60	100	75	90	130	110	90	100			200	280	250	350	320	400 Rm	1050 Rm	550	630	400	550
Recommend	◎	◎	◎	◎	◎																

HSSCo8, 2 FLUTE SHORT LENGTH

- HSSCo8, 2 SCHNEIDEN KURZ
- Fraise HSSCo8, 2 dents, courte
- 2 TAGLIANTI, SERIE CORTA - HSSCo8

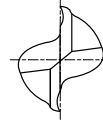

P.746~749

Unit : mm

EDP No.		Mill Diameter	Shank Diameter	Length of Cut	Overall Length
UNCOATED	TiAIN	e8	h6		
E2570095	EQ570095	9.5	10	11	61
E2570097	EQ570097	9.7	10	13	63
E2570100	EQ570100	10.0	10	13	63
E2570105	EQ570105	10.5	12	13	70
E2570107	EQ570107	10.7	12	13	70
E2570110	EQ570110	11.0	12	13	70
E2570115	EQ570115	11.5	12	13	70
E2570117	EQ570117	11.7	12	16	73
E2570120	EQ570120	12.0	12	16	73
E2570125	EQ570125	12.5	12	16	73
E2570127	EQ570127	12.7	12	16	73
E2570130	EQ570130	13.0	12	16	73
E2570135	EQ570135	13.5	12	16	73
E2570137	EQ570137	13.7	12	16	73
E2570140	EQ570140	14.0	12	16	73
E2570147	EQ570147	14.7	12	16	73
E2570150	EQ570150	15.0	12	16	73
E2570157	EQ570157	15.7	16	19	79
E2570160	EQ570160	16.0	16	19	79
E2570167	EQ570167	16.7	16	19	79
E2570170	EQ570170	17.0	16	19	79
E2570177	EQ570177	17.7	16	19	79
E2570180	EQ570180	18.0	16	19	79
E2570190	EQ570190	19.0	16	19	79

Tolerances according to DIN 7160 & 7161

▶ Other shank design on your request. ▶ NEXT PAGE
 ▶ TiN and TiCN Coatings are available on your request.

Tolerance range in μm						
Nominal-Diameter in mm						
	from 1 to 3	over 3 to 6	over 6 to 10	over 10 to 18	over 18 to 30	over 30 to 50
e8	- 14 - 28	- 20 - 38	- 25 - 47	- 32 - 59	- 40 - 73	- 50 - 89
h6	0 - 6	0 - 8	0 - 9	0 - 11	0 - 13	0 - 16

◎ : Excellent ○ : Good

ISO Material Description	P										M			K							
	Non-alloy steel					Low alloy steel					High alloyed steel, and tool steel			Stainless steel			Grey cast iron		Nodular cast iron		Malleable cast iron
VDI 3323	1	2	3	4	5	6	7	8	9	10	11	12	13	14	15	16	17	18	19	20	
HRC		13	25	28	32	10	29	32	38	15	35	15	23	10	10	26	3	25		21	
HB	125	190	250	270	300	180	275	300	350	200	325	200	240	180	180	260	160	250	130	230	
Recommend	◎	◎	◎	◎	○	◎	◎	○	○	◎	○										

ISO Material Description	N					S										H					
	Aluminum-wrought alloy		Aluminum-cast, alloyed			Copper and Copper Alloys (Bronze / Brass)			Non Metallic Materials		Heat Resistant Super Alloys					Titanium Alloys		Hardened steel	Chilled Cast Iron	Hardened Cast Iron	
VDI 3323	21	22	23	24	25	26	27	28	29	30	31	32	33	34	35	36	37	38	39	40	41
HRC											15	30	25	38	34			55	60	42	55
HB	60	100	75	90	130	110	90	100			200	280	250	350	320	400 Rm	1050 Rm	550	630	400	550
Recommend	○	○	○	○	○																



FLAT SHANK

E2570 SERIES

FLAT SHANK

EQ570 SERIES

HSSCo8, 2 FLUTE SHORT LENGTH

- HSSCo8, 2 SCHNEIDEN KURZ
- Fraise HSSCo8, 2 dents, courte
- 2 TAGLIENTI, SERIE CORTA - HSSCo8

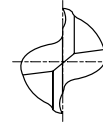

P.746~749

Unit : mm

EDP No.	Mill Diameter	Shank Diameter	Length of Cut	Overall Length	
					UNCOATED
E2570197	EQ570197	19.7	20	22	88
E2570920	EQ570920	20.0	16	22	82
E2570200	EQ570200	20.0	20	22	88
E2570210	EQ570210	21.0	20	22	88
E2570220	EQ570220	22.0	20	22	88
E2570922	EQ570922	22.0	25	22	98
E2570240	EQ570240	24.0	25	26	102
E2570250	EQ570250	25.0	25	26	102
E2570260	EQ570260	26.0	25	26	102
E2570270	EQ570270	27.0	25	26	102
E2570280	EQ570280	28.0	25	26	102
E2570290	EQ570290	29.0	25	26	102
E2570300	EQ570300	30.0	25	26	102
E2570320	EQ570320	32.0	32	32	112
E2570340	EQ570340	34.0	32	32	112
E2570350	EQ570350	35.0	32	32	112
E2570360	EQ570360	36.0	32	32	112
E2570380	EQ570380	38.0	32	38	118
E2570938	EQ570938	38.0	40	38	130
E2570400	EQ570400	40.0	32	38	118
E2570903	EQ570903	40.0	40	38	130

- ▶ Other shank design on your request.
- ▶ TiN and TiCN Coatings are available on your request.

Tolerances according to DIN 7160 & 7161

	Tolerance range in μm					
	Nominal-Diameter in mm					
	from 1 to 3	over 3 to 6	over 6 to 10	over 10 to 18	over 18 to 30	over 30 to 50
e8	-14 -28	-20 -38	-25 -47	-32 -59	-40 -73	-50 -89
h6	0 -6	0 -8	0 -9	0 -11	0 -13	0 -16

◎ : Excellent ○ : Good

ISO Material Description	P											M			K						
	Non-alloy steel					Low alloy steel				High alloyed steel, and tool steel		Stainless steel			Grey cast iron		Nodular cast iron		Malleable cast iron		
VDI 3323	1	2	3	4	5	6	7	8	9	10	11	12	13	14	15	16	17	18	19	20	
HRc		13	25	28	32	10	29	32	38	15	35	15	23	10	10	26	3	25		21	
HB	125	190	250	270	300	180	275	300	350	200	325	200	240	180	180	260	160	250	130	230	
Recommend	◎	◎	◎	◎	◎	◎	◎	◎	◎	◎	◎	◎	◎	◎	◎	◎	◎	◎	◎	◎	
ISO Material Description	N									S						H					
	Aluminum-wrought alloy		Aluminum-cast, alloyed			Copper and Copper Alloys (Bronze / Brass)		Non Metallic Materials		Heat Resistant Super Alloys			Titanium Alloys			Hardened steel		Chilled Cast Iron	Hardened Cast Iron		
VDI 3323	21	22	23	24	25	26	27	28	29	30	31	32	33	34	35	36	37	38	39	40	41
HRc											15	30	25	38	34			55	60	42	55
HB	60	100	75	90	130	110	90	100			200	280	250	350	320	400 Rm	1050 Rm	550	630	400	550
Recommend	◎	◎	◎	◎	◎	◎	◎	◎	◎	◎	◎	◎	◎	◎	◎	◎	◎	◎	◎	◎	◎

HSSCo8, 2 FLUTE LONG LENGTH

- HSSCo8, 2 SCHNEIDEN LANG
- Fraise HSSCo8, 2 dents, longue
- 2 TAGLIANTI, SERIE LUNGA - HSSCo8



HSS Co8
DIN 844
2
≈ 30°
DIN 1835B
↗ ↘
↗ ↘
P.746~749

Unit : mm

EDP No.		Mill Diameter	Shank Diameter	Length of Cut	Overall Length
UNCOATED	TiAIN	e8	h6		
E2571015	EQ571015	1.5	6	7	51
E2571020	EQ571020	2.0	6	7	51
E2571025	EQ571025	2.5	6	8	52
E2571030	EQ571030	3.0	6	8	52
E2571035	EQ571035	3.5	6	10	54
E2571040	EQ571040	4.0	6	11	55
E2571045	EQ571045	4.5	6	11	55
E2571050	EQ571050	5.0	6	13	57
E2571055	EQ571055	5.5	6	13	57
E2571060	EQ571060	6.0	6	13	57
E2571065	EQ571065	6.5	10	16	66
E2571070	EQ571070	7.0	10	16	66
E2571075	EQ571075	7.5	10	16	66
E2571080	EQ571080	8.0	10	19	69
E2571085	EQ571085	8.5	10	19	69
E2571090	EQ571090	9.0	10	19	69
E2571095	EQ571095	9.5	10	19	69
E2571100	EQ571100	10.0	10	22	72
E2571110	EQ571110	11.0	12	22	79
E2571120	EQ571120	12.0	12	26	83
E2571130	EQ571130	13.0	12	26	83
E2571140	EQ571140	14.0	12	26	83
E2571150	EQ571150	15.0	12	26	83
E2571160	EQ571160	16.0	16	32	92

Tolerances according to DIN 7160 & 7161

Tolerance range in μm						
Nominal-Diameter in mm						
	from 1 to 3	over 3 to 6	over 6 to 10	over 10 to 18	over 18 to 30	over 30 to 50
e8	- 14 - 28	- 20 - 38	- 25 - 47	- 32 - 59	- 40 - 73	- 50 - 89
h6	0 - 6	0 - 8	0 - 9	0 - 11	0 - 13	0 - 16

▶ Other shank design on your request. ▶ NEXT PAGE
 ▶ TiN and TiCN Coatings are available on your request.

◎ : Excellent ○ : Good

ISO Material Description	P										M				K						
	Non-alloy steel					Low alloy steel					High alloyed steel, and tool steel				Stainless steel		Grey cast iron		Nodular cast iron		Malleable cast iron
VDI 3323	1	2	3	4	5	6	7	8	9	10	11	12	13	14	15	16	17	18	19	20	
HRC		13	25	28	32	10	29	32	38	15	35	15	23	10	10	26	3	25		21	
HB	125	190	250	270	300	180	275	300	350	200	325	200	240	180	180	260	160	250	130	230	
Recommend	◎	◎	◎	◎	○	◎	◎	○	○	◎	○										

ISO Material Description	N					S					H										
	Aluminum-wrought alloy		Aluminum-cast, alloyed		Copper and Copper Alloys (Bronze / Brass)	Non Metallic Materials	Heat Resistant Super Alloys				Titanium Alloys		Hardened steel	Chilled Cast Iron	Hardened Cast Iron						
VDI 3323	21	22	23	24	25	26	27	28	29	30	31	32	33	34	35	36	37	38	39	40	41
HRC											15	30	25	38	34			55	60	42	55
HB	60	100	75	90	130	110	90	100			200	280	250	350	320	400 Rm	1050 Rm	550	630	400	550
Recommend	○	○	○	○	○																



FLAT SHANK

E2571 SERIES

FLAT SHANK

EQ571 SERIES

HSSCo8, 2 FLUTE LONG LENGTH

- HSSCo8, 2 SCHNEIDEN LANG
- Fraise HSSCo8, 2 dents, longue
- 2 TAGLIENTI, SERIE LUNGA - HSSCo8

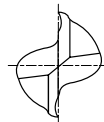

P.746~749

Unit : mm

EDP No.	Mill Diameter	Shank Diameter	Length of Cut	Overall Length
E2571180	18.0	16	32	92
E2571200	20.0	20	38	104
E2571220	22.0	20	38	104
E2571240	24.0	25	45	121
E2571250	25.0	25	45	121
E2571260	26.0	25	45	121
E2571270	27.0	25	45	121
E2571280	28.0	25	45	121
E2571300	30.0	25	45	121
E2571320	32.0	32	53	133
E2571400	40.0	40	63	155

- ▶ Other shank design on your request.
- ▶ TiN and TiCN Coatings are available on your request.

Tolerances according to DIN 7160 & 7161

Tolerance range in μm						
Nominal-Diameter in mm						
	from 1 to 3	over 3 to 6	over 6 to 10	over 10 to 18	over 18 to 30	over 30 to 50
e8	-14 -28	-20 -38	-25 -47	-32 -59	-40 -73	-50 -89
h6	0 -6	0 -8	0 -9	0 -11	0 -13	0 -16

◎ : Excellent ○ : Good

ISO Material Description	P											M			K						
	Non-alloy steel					Low alloy steel				High alloyed steel, and tool steel		Stainless steel			Grey cast iron		Nodular cast iron	Malleable cast iron			
VDI 3323	1	2	3	4	5	6	7	8	9	10	11	12	13	14	15	16	17	18	19	20	
HRc	13	25	28	32	10	29	32	38	15	35	15	23	10	10	26	3	25		21		
HB	125	190	250	270	300	180	275	300	350	200	325	200	240	180	180	260	160	250	130	230	
Recommend	◎	◎	◎	◎	○	◎	◎	○	○	◎	○										
ISO Material Description	N										S					H					
	Aluminum-wrought alloy		Aluminum-cast, alloyed			Copper and Copper Alloys (Bronze / Brass)		Non Metallic Materials			Heat Resistant Super Alloys					Titanium Alloys		Hardened steel	Chilled Cast Iron	Hardened Cast Iron	
VDI 3323	21	22	23	24	25	26	27	28	29	30	31	32	33	34	35	36	37	38	39	40	41
HRc											15	30	25	38	34			55	60	42	55
HB	60	100	75	90	130	110	90	100			200	280	250	350	320	400 Rm	1050 Rm	550	630	400	550
Recommend	○	○	○	○	○																

HSSCo8, 2 FLUTE EXTRA LONG LENGTH

- HSSCo8, 2 SCHNEIDEN EXTRA LANG
- Fraise HSSCo8, 2 dents, extra-longue
- 2 TAGLIANTI, SERIE EXTRA LUNGA - HSSCo8

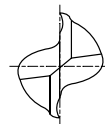

HSS Co8
DIN 844
2
30°
DIN 1835B
P.746~749

Unit : mm

EDP No.		Mill Diameter	Shank Diameter	Length of Cut	Overall Length
UNCOATED	TiAIN	e8	h6		
E2510025	EQ510025	2.5	6	8	56
E2510030	EQ510030	3.0	6	8	56
E2510035	EQ510035	3.5	6	10	59
E2510040	EQ510040	4.0	6	11	63
E2510045	EQ510045	4.5	6	11	63
E2510050	EQ510050	5.0	6	13	68
E2510055	EQ510055	5.5	6	13	68
E2510060	EQ510060	6.0	6	13	68
E2510065	EQ510065	6.5	10	16	80
E2510070	EQ510070	7.0	10	16	80
E2510080	EQ510080	8.0	10	19	88
E2510085	EQ510085	8.5	10	19	88
E2510090	EQ510090	9.0	10	19	88
E2510100	EQ510100	10.0	10	22	95
E2510120	EQ510120	12.0	12	26	110
E2510140	EQ510140	14.0	12	26	110
E2510160	EQ510160	16.0	16	32	123
E2510180	EQ510180	18.0	16	32	123
E2510200	EQ510200	20.0	20	38	141
E2510220	EQ510220	22.0	20	38	141
E2510240	EQ510240	24.0	25	45	166
E2510250	EQ510250	25.0	25	45	166
E2510260	EQ510260	26.0	25	45	166
E2510280	EQ510280	28.0	25	45	166
E2510300	EQ510300	30.0	25	45	166
E2510320	EQ510320	32.0	32	53	186
E2510360	EQ510360	36.0	32	53	186
E2510400	EQ510400	40.0	32	63	207
E2510940	EQ510940	40.0	40	63	217

Tolerances according to DIN 7160 & 7161

Tolerance range in μm						
Nominal-Diameter in mm						
	from 1 to 3	over 3 to 6	over 6 to 10	over 10 to 18	over 18 to 30	over 30 to 50
e8	-14 -28	-20 -38	-25 -47	-32 -59	-40 -73	-50 -89
h6	0 -6	0 -8	0 -9	0 -11	0 -13	0 -16

- ▶ Other shank design on your request.
- ▶ TiN and TiCN Coatings are available on your request.

◎ : Excellent ○ : Good

ISO Material Description	P										M			K							
	Non-alloy steel					Low alloy steel					High alloyed steel, and tool steel			Stainless steel			Grey cast iron		Nodular cast iron		Malleable cast iron
VDI 3323	1	2	3	4	5	6	7	8	9	10	11	12	13	14	15	16	17	18	19	20	
HRC		13	25	28	32	10	29	32	38	15	35	15	23	10	10	26	3	25		21	
HB	125	190	250	270	300	180	275	300	350	200	325	200	240	180	180	260	160	250	130	230	
Recommend	◎	◎	◎	◎	○	◎	◎	○	○	◎	○										

ISO Material Description	N					S					H										
	Aluminum-wrought alloy		Aluminum-cast, alloyed		Copper and Copper Alloys (Bronze / Brass)	Non Metallic Materials	Heat Resistant Super Alloys			Titanium Alloys		Hardened steel	Chilled Cast Iron	Hardened Cast Iron							
VDI 3323	21	22	23	24	25	26	27	28	29	30	31	32	33	34	35	36	37	38	39	40	41
HRC											15	30	25	38	34			55	60	42	55
HB	60	100	75	90	130	110	90	100			200	280	250	350	320	400 Rm	1050 Rm	550	630	400	550
Recommend	○	○	○	○	○																

CBN END MILLS

i-Xmill END MILLS

i-SMART MODULAR END MILLS

X5070 END MILLS

4G MILL END MILLS

X-POWER PRO END MILLS

TitaNox-POWER END MILLS

JET-POWER END MILLS

V7 PLUS END MILLS

ALU-POWER HPC END MILLS

ALU-POWER END MILLS

D-POWER GRAPHITE END MILLS

D-POWER CFRP END MILLS

ROUTERS

CRX S END MILLS

K-2 END MILLS

ONLY ONE COATED PM60 END MILLS

TANK-POWER END MILLS

GENERAL HSS END MILLS

MILLING CUTTERS

TECHNICAL DATA

HSSCo8, 2 FLUTE 42° HELIX SHORT LENGTH for ALUMINIUM

🇩🇪 **HSSCo8, 2 SCHNEIDEN 42° RECHTSSPIRALE KURZ für ALUMINIUM**
🇫🇷 **Fraise HSSCo8, 2 dents, hélice 42°, pour aluminium, courte**
🇮🇹 **2 TAGLIENTI, ELICA 42°, SERIE CORTA - HSSCo8**

for ALUMINIUM
für ALUMINIUM

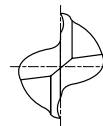

P.748~749

Unit : mm

EDP No.	Mill Diameter	Shank Diameter	Length of Cut	Overall Length
UNCOATED	e8	h6		
E2464010	1.0	6	3	49
E2464015	1.5	6	5	49
E2464020	2.0	6	7	51
E2464025	2.5	6	8	52
E2464030	3.0	6	8	52
E2464035	3.5	6	10	54
E2464040	4.0	6	11	55
E2464045	4.5	6	11	55
E2464050	5.0	6	13	57
E2464055	5.5	6	13	57
E2464060	6.0	6	13	57
E2464065	6.5	10	16	66
E2464070	7.0	10	16	66
E2464075	7.5	10	16	66
E2464080	8.0	10	19	69
E2464085	8.5	10	19	69
E2464090	9.0	10	19	69
E2464100	10.0	10	22	72
E2464110	11.0	12	22	79
E2464120	12.0	12	26	83
E2464130	13.0	12	26	83
E2464140	14.0	12	26	83
E2464150	15.0	12	26	83
E2464160	16.0	16	32	92

Tolerances according to DIN 7160 & 7161

▶ Other shank design on your request.

▶ NEXT PAGE

▶ TiN and TiCN Coatings are available on your request.

Tolerance range in μm						
Nominal-Diameter in mm						
	from 1 to 3	over 3 to 6	over 6 to 10	over 10 to 18	over 18 to 30	over 30 to 50
e8	-14 -28	-20 -38	-25 -47	-32 -59	-40 -73	-50 -89
h6	0 -6	0 -8	0 -9	0 -11	0 -13	0 -16

◎ : Excellent ○ : Good

ISO Material Description	P										M			K							
	Non-alloy steel					Low alloy steel					High alloyed steel, and tool steel			Stainless steel			Grey cast iron		Nodular cast iron		Malleable cast iron
VDI 3323	1	2	3	4	5	6	7	8	9	10	11	12	13	14	15	16	17	18	19	20	
HRc		13	25	28	32	10	29	32	38	15	35	15	23	10	10	26	3	25	42	21	
HB	125	190	250	270	300	180	275	300	350	200	325	200	240	180	180	260	160	250	130	230	
Recommend	○	○				○				○											
ISO Material Description	N										S						H				
	Aluminum-wrought alloy		Aluminum-cast, alloyed			Copper and Copper Alloys (Bronze / Brass)			Non Metallic Materials		Heat Resistant Super Alloys						Titanium Alloys		Hardened steel	Chilled Cast Iron	Hardened Cast Iron
VDI 3323	21	22	23	24	25	26	27	28	29	30	31	32	33	34	35	36	37	38	39	40	41
HRc											15	30	25	38	34			55	60	42	55
HB	60	100	75	90	130	110	90	100			200	280	250	350	320	400 Rm	1050 Rm	550	630	400	550
Recommend	◎	◎	◎	◎	○																

HSSCo8, 2 FLUTE 42° HELIX SHORT LENGTH for ALUMINIUM

- HSSCo8, 2 SCHNEIDEN 42° RECHTSSPIRALE KURZ für ALUMINIUM
- Fraise HSSCo8, 2 dents, hélice 42°, pour aluminium, courte
- 2 TAGLIANTI, ELICA 42°, SERIE CORTA - HSSCo8

for ALUMINIUM
für ALUMINIUM

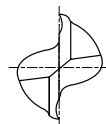

Unit : mm

EDP No.	Mill Diameter	Shank Diameter	Length of Cut	Overall Length
UNCOATED	e8	h6		
E2464200	20.0	20	38	104
E2464210	21.0	20	38	104
E2464220	22.0	20	38	104
E2464230	23.0	20	38	104
E2464240	24.0	25	45	121
E2464250	25.0	25	45	121
E2464260	26.0	25	45	121
E2464280	28.0	25	45	121
E2464300	30.0	25	45	121
E2464320	32.0	32	53	133

- ▶ Other shank design on your request.
- ▶ TiN and TiCN Coatings are available on your request.

Tolerances according to DIN 7160 & 7161

	Tolerance range in μm					
	Nominal-Diameter in mm					
	from 1 to 3	over 3 to 6	over 6 to 10	over 10 to 18	over 18 to 30	over 30 to 50
e8	-14 -28	-20 -38	-25 -47	-32 -59	-40 -73	-50 -89
h6	0 -6	0 -8	0 -9	0 -11	0 -13	0 -16

◎ : Excellent ○ : Good

ISO	P										M				K						
	Non-alloy steel					Low alloy steel					High alloyed steel, and tool steel				Stainless steel		Grey cast iron		Nodular cast iron		Malleable cast iron
Material Description	1	2	3	4	5	6	7	8	9	10	11	12	13	14	15	16	17	18	19	20	
VDI 3323	1	2	3	4	5	6	7	8	9	10	11	12	13	14	15	16	17	18	19	20	
HRC	13	25	28	32	10	29	32	38	15	35	15	23	10	10	26	3	25	42	55		
HB	125	190	250	270	300	180	275	300	350	200	325	200	240	180	180	260	160	250	130	230	
Recommend	○	○				○				○											
ISO	N									S						H					
Material Description	Aluminum-wrought alloy		Aluminum-cast, alloyed			Copper and Copper Alloys (Bronze / Brass)			Non Metallic Materials		Heat Resistant Super Alloys				Titanium Alloys		Hardened steel	Chilled Cast Iron	Hardened Cast Iron		
VDI 3323	21	22	23	24	25	26	27	28	29	30	31	32	33	34	35	36	37	38	39	40	41
HRC	21	22	23	24	25	26	27	28	29	30	31	30	25	38	34	36	37	55	60	42	55
HB	60	100	75	90	130	110	90	100			200	280	250	350	320	400 Rm	1050 Rm	550	630	400	550
Recommend	◎	◎	◎	◎	○																

CBN END MILLS

i-Xmill END MILLS

i-SMART MODULAR END MILLS

X5070 END MILLS

4G MILL END MILLS

X-POWER PRO END MILLS

TitaNox-POWER END MILLS

JET-POWER END MILLS

V7 PLUS END MILLS

ALU-POWER HPC END MILLS

ALU-POWER END MILLS

D-POWER GRAPHITE END MILLS

D-POWER CFRP END MILLS

ROUTERS

CRX S END MILLS

K-2 END MILLS

ONLY ONE COATED PM60 END MILLS

TANK-POWER END MILLS

GENERAL HSS END MILLS

MILLING CUTTERS

TECHNICAL DATA



HSSCo8, 2 FLUTE 42° HELIX LONG LENGTH for ALUMINUM

- HSSCo8, 2 SCHNEIDEN 42° RECHTSSPIRALE KURZ für ALUMINIUM
- Fraise HSSCo8, 2 dents, hélice 42°, pour aluminium, longue
- 2 TAGLIENTI, ELICA 42°, SERIE LUNGA - HSSCo8

for ALUMINUM
für ALUMINIUM

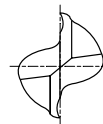

P.748~749

Unit : mm

EDP No.	Mill Diameter	Shank Diameter	Length of Cut	Overall Length
UNCOATED	e8	h6		
E2509020	2.0	6	10	54
E2509030	3.0	6	12	56
E2509040	4.0	6	19	63
E2509050	5.0	6	24	68
E2509060	6.0	6	24	68
E2509070	7.0	10	30	80
E2509080	8.0	10	38	88
E2509090	9.0	10	38	88
E2509100	10.0	10	45	95
E2509110	11.0	12	45	102
E2509120	12.0	12	53	110
E2509130	13.0	12	53	110
E2509140	14.0	12	53	110
E2509150	15.0	12	53	110
E2509160	16.0	16	63	123
E2509180	18.0	16	63	123
E2509200	20.0	20	75	141

- ▶ Other shank design on your request.
- ▶ TiN and TiCN Coatings are available on your request.

Tolerances according to DIN 7160 & 7161

	Tolerance range in μm					
	Nominal-Diameter in mm					
	from 1 to 3	over 3 to 6	over 6 to 10	over 10 to 18	over 18 to 30	over 30 to 50
e8	-14 -28	-20 -38	-25 -47	-32 -59	-40 -73	-50 -89
h6	0 -6	0 -8	0 -9	0 -11	0 -13	0 -16

◎ : Excellent ○ : Good

ISO Material Description	P										M			K							
	Non-alloy steel					Low alloy steel					High alloyed steel, and tool steel			Stainless steel			Grey cast iron		Nodular cast iron	Malleable cast iron	
VDI 3323	1	2	3	4	5	6	7	8	9	10	11	12	13	14	15	16	17	18	19	20	
HRc		13	25	28	32	10	29	32	38	15	35	15	23	10	10	26	3	25		21	
HB	125	190	250	270	300	180	275	300	350	200	325	200	240	180	180	260	160	250	130	230	
Recommend	○	○				○				○											
ISO Material Description	N										S						H				
	Aluminum-wrought alloy		Aluminum-cast, alloyed			Copper and Copper Alloys (Bronze / Brass)			Non Metallic Materials		Heat Resistant Super Alloys						Titanium Alloys		Hardened steel	Chilled Cast Iron	Hardened Cast Iron
VDI 3323	21	22	23	24	25	26	27	28	29	30	31	32	33	34	35	36	37	38	39	40	41
HRc											15	30	25	38	34			55	60	42	55
HB	60	100	75	90	130	110	90	100			200	280	250	350	320	400 Rm	1050 Rm	550	630	400	550
Recommend	◎	◎	◎	◎	○																

HSSCo8, 3 FLUTE STUB LENGTH

- HSSCo8, 3 SCHNEIDEN EXTRA KURZ
- Fraise HSSCo8, 3 dents, extra-courte
- 3 TAGLIANTI. SERIE EXTRA CORTA - HSSCo8

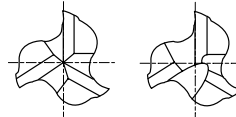

Under Ø3mm Ø3mm or above

HSS Co8
DIN 327
3
≈ 30°
DIN 1835B
P.750~757

Unit : mm

EDP No.		Mill Diameter	Shank Diameter	Length of Cut	Overall Length
UNCOATED	TiAIN	e8	h6		
E2572015	EQ572015	1.5	6	3	47
E2572020	EQ572020	2.0	6	4	48
E2572025	EQ572025	2.5	6	5	49
E2572030	EQ572030	3.0	6	5	49
E2572035	EQ572035	3.5	6	6	50
E2572040	EQ572040	4.0	6	7	51
E2572045	EQ572045	4.5	6	7	51
E2572050	EQ572050	5.0	6	8	52
E2572055	EQ572055	5.5	6	8	52
E2572060	EQ572060	6.0	6	8	52
E2572065	EQ572065	6.5	10	10	60
E2572070	EQ572070	7.0	10	10	60
E2572075	EQ572075	7.5	10	10	60
E2572080	EQ572080	8.0	10	11	61
E2572085	EQ572085	8.5	10	11	61
E2572100	EQ572100	10.0	10	13	63
E2572120	EQ572120	12.0	12	16	73
E2572140	EQ572140	14.0	12	16	73
E2572150	EQ572150	15.0	12	16	73
E2572160	EQ572160	16.0	16	19	79
E2572180	EQ572180	18.0	16	19	79
E2572200	EQ572200	20.0	20	22	88
E2572220	EQ572220	22.0	20	22	88
E2572240	EQ572240	24.0	25	26	102
E2572250	EQ572250	25.0	25	26	102
E2572260	EQ572260	26.0	25	26	102
E2572280	EQ572280	28.0	25	26	102
E2572300	EQ572300	30.0	25	26	102
E2572320	EQ572320	32.0	32	32	112

Tolerances according to DIN 7160 & 7161

	Tolerance range in μm					
	Nominal-Diameter in mm					
	from 1 to 3	over 3 to 6	over 6 to 10	over 10 to 18	over 18 to 30	over 30 to 50
e8	-14 -28	-20 -38	-25 -47	-32 -59	-40 -73	-50 -89
h6	0 -6	0 -8	0 -9	0 -11	0 -13	0 -16

- ▶ Other shank design on your request.
- ▶ TiN and TiCN Coatings are available on your request.

◎ : Excellent ○ : Good

ISO Material Description	P										M			K						
	Non-alloy steel					Low alloy steel					High alloyed steel, and tool steel			Stainless steel			Grey cast iron		Nodular cast iron	
VDI 3323	1	2	3	4	5	6	7	8	9	10	11	12	13	14	15	16	17	18	19	20
HRC		13	25	28	32	10	29	32	38	15	35	15	23	10	10	26	3	25		21
HB	125	190	250	270	300	180	275	300	350	200	325	200	240	180	180	260	160	250	130	230
Recommend	◎	◎	◎	◎	◎	◎	◎	◎	◎	◎	◎									

ISO Material Description	N					S					H										
	Aluminum-wrought alloy		Aluminum-cast, alloyed		Copper and Copper Alloys (Bronze / Brass)		Non Metallic Materials		Heat Resistant Super Alloys			Titanium Alloys		Hardened steel	Chilled Cast Iron	Hardened Cast Iron					
VDI 3323	21	22	23	24	25	26	27	28	29	30	31	32	33	34	35	36	37	38	39	40	41
HRC											15	30	25	38	34			55	60	42	55
HB	60	100	75	90	130	110	90	100			200	280	250	350	320	400 Rm	1050 Rm	550	630	400	550
Recommend	◎	◎	◎	◎	◎																



FLAT SHANK

E2573 SERIES

FLAT SHANK

EQ573 SERIES

HSSCo8, 3 FLUTE SHORT LENGTH

- HSSCo8, 3 SCHNEIDEN KURZ**
- Fraise HSSCo8, 3 dents, courte**
- 3 TAGLIENTI, SERIE CORTA - HSSCo8**

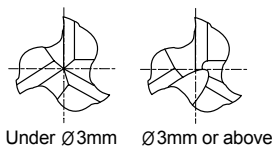

Under \varnothing 3mm \varnothing 3mm or above

HSS
Co8

DIN
844

3

30°

DIN
1835B

P.750~757

Unit : mm

EDP No.		Mill Diameter	Shank Diameter	Length of Cut	Overall Length
UNCOATED	TiAIN	e8	h6		
E2573010	EQ573010	1.0	6	3	47
E2573015	EQ573015	1.5	6	7	51
E2573020	EQ573020	2.0	6	7	51
E2573025	EQ573025	2.5	6	8	52
E2573030	EQ573030	3.0	6	8	52
E2573035	EQ573035	3.5	6	10	54
E2573040	EQ573040	4.0	6	11	55
E2573045	EQ573045	4.5	6	11	55
E2573050	EQ573050	5.0	6	13	57
E2573055	EQ573055	5.5	6	13	57
E2573060	EQ573060	6.0	6	13	57
E2573065	EQ573065	6.5	10	16	66
E2573070	EQ573070	7.0	10	16	66
E2573075	EQ573075	7.5	10	16	66
E2573080	EQ573080	8.0	10	19	69
E2573085	EQ573085	8.5	10	19	69
E2573090	EQ573090	9.0	10	19	69
E2573095	EQ573095	9.5	10	19	69
E2573100	EQ573100	10.0	10	22	72
E2573120	EQ573120	12.0	12	26	83
E2573140	EQ573140	14.0	12	26	83
E2573150	EQ573150	15.0	12	26	83
E2573160	EQ573160	16.0	16	32	92
E2573180	EQ573180	18.0	16	32	92

Tolerances according to DIN 7160 & 7161

- ▶ Other shank design on your request.
- ▶ TiN and TiCN Coatings are available on your request.

▶ NEXT PAGE

Tolerance range in μ m						
Nominal-Diameter in mm						
	from 1 to 3	over 3 to 6	over 6 to 10	over 10 to 18	over 18 to 30	over 30 to 50
e8	-14 -28	-20 -38	-25 -47	-32 -59	-40 -73	-50 -89
h6	0 -6	0 -8	0 -9	0 -11	0 -13	0 -16

◎ : Excellent ○ : Good

ISO Material Description	P											M			K						
	Non-alloy steel					Low alloy steel						High alloyed steel, and tool steel			Stainless steel			Grey cast iron		Nodular cast iron	
VDI 3323	1	2	3	4	5	6	7	8	9	10	11	12	13	14	15	16	17	18	19	20	
HRc		13	25	28	32	10	29	32	38	15	35	15	23	10	10	26	3	25		21	
HB	125	190	250	270	300	180	275	300	350	200	325	200	240	180	180	260	160	250	130	230	
Recommend	◎	◎	◎	◎	◎	◎	◎	◎	◎	◎	◎	◎	◎	◎	◎	◎	◎	◎	◎	◎	
ISO Material Description	N										S					H					
	Aluminum-wrought alloy		Aluminum-cast, alloyed			Copper and Copper Alloys (Bronze / Brass)			Non Metallic Materials		Heat Resistant Super Alloys					Titanium Alloys		Hardened steel	Chilled Cast Iron	Hardened Cast Iron	
VDI 3323	21	22	23	24	25	26	27	28	29	30	31	32	33	34	35	36	37	38	39	40	41
HRc											15	30	25	38	34			55	60	42	55
HB	60	100	75	90	130	110	90	100			200	280	250	350	320	400 Rm	1050 Rm	550	630	400	550
Recommend	◎	◎	◎	◎	◎																

HSSCo8, 3 FLUTE SHORT LENGTH

- HSSCo8, 3 SCHNEIDEN KURZ
- Fraise HSSCo8, 3 dents, courte
- 3 TAGLIANTI, SERIE CORTA - HSSCo8

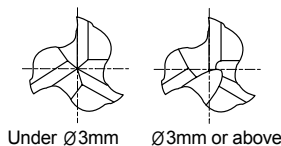

Unit : mm

EDP No.		Mill Diameter	Shank Diameter	Length of Cut	Overall Length
UNCOATED	TiAIN	e8	h6		
E2573200	EQ573200	20.0	20	38	104
E2573220	EQ573220	22.0	20	38	104
E2573240	EQ573240	24.0	25	45	121
E2573250	EQ573250	25.0	25	45	121
E2573260	EQ573260	26.0	25	45	121
E2573280	EQ573280	28.0	25	45	121
E2573300	EQ573300	30.0	25	45	121
E2573320	EQ573320	32.0	32	53	133
E2573400	EQ573400	40.0	40	63	155

- ▶ Other shank design on your request.
- ▶ TiN and TiCN Coatings are available on your request.

Tolerances according to DIN 7160 & 7161

	Tolerance range in μm					
	Nominal-Diameter in mm					
	from 1 to 3	over 3 to 6	over 6 to 10	over 10 to 18	over 18 to 30	over 30 to 50
e8	-14 -28	-20 -38	-25 -47	-32 -59	-40 -73	-50 -89
h6	0 -6	0 -8	0 -9	0 -11	0 -13	0 -16

◎ : Excellent ○ : Good

ISO Material Description	P										M			K							
	Non-alloy steel					Low alloy steel					High alloyed steel, and tool steel			Stainless steel			Grey cast iron		Nodular cast iron		Malleable cast iron
VDI 3323	1	2	3	4	5	6	7	8	9	10	11	12	13	14	15	16	17	18	19	20	
HRc																					
HB	125	190	250	270	300	180	275	300	350	200	325	200	240	180	180	260	160	250	130	230	
Recommend	◎	◎	◎	◎	◎	◎	◎	◎	○	◎	◎										

ISO Material Description	N					S					H										
	Aluminum-wrought alloy		Aluminum-cast, alloyed			Copper and Copper Alloys (Bronze / Brass)			Non Metallic Materials		Heat Resistant Super Alloys			Titanium Alloys		Hardened steel	Chilled Cast Iron	Hardened Cast Iron			
VDI 3323	21	22	23	24	25	26	27	28	29	30	31	32	33	34	35	36	37	38	39	40	41
HRc																					
HB	60	100	75	90	130	110	90	100			15	30	25	38	34	200	280	250	350	400 Rm	1050 Rm
Recommend	○	○	○	○	○																



FLAT SHANK

E2516 SERIES

FLAT SHANK

EQ516 SERIES

HSSCo8, 3 FLUTE LONG LENGTH

- HSSCo8, 3 SCHNEIDEN LANG
- Fraise HSSCo8, 3 dents, longue
- 3 TAGLIENTI, SERIE LUNGA - HSSCo8

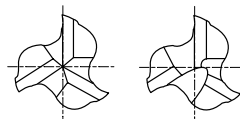

Up to $\varnothing 2.5\text{mm}$ Over $\varnothing 2.5\text{mm}$

HSS
Co8

DIN
844

3

30°

DIN
1835B

P.750~757

Unit : mm

EDP No.		Mill Diameter	Shank Diameter	Length of Cut	Overall Length
UNCOATED	TiAIN	e8	h6		
E2516020	EQ516020	2.0	6	10	54
E2516025	EQ516025	2.5	6	12	56
E2516030	EQ516030	3.0	6	12	56
E2516035	EQ516035	3.5	6	15	59
E2516040	EQ516040	4.0	6	19	63
E2516045	EQ516045	4.5	6	19	63
E2516050	EQ516050	5.0	6	24	68
E2516055	EQ516055	5.5	6	24	68
E2516060	EQ516060	6.0	6	24	68
E2516070	EQ516070	7.0	10	30	80
E2516075	EQ516075	7.5	10	30	80
E2516080	EQ516080	8.0	10	38	88
E2516090	EQ516090	9.0	10	38	88
E2516100	EQ516100	10.0	10	45	95
E2516110	EQ516110	11.0	12	45	102
E2516120	EQ516120	12.0	12	53	110
E2516130	EQ516130	13.0	12	53	110
E2516140	EQ516140	14.0	12	53	110
E2516150	EQ516150	15.0	12	53	110
E2516160	EQ516160	16.0	16	63	123
E2516170	EQ516170	17.0	16	63	123
E2516180	EQ516180	18.0	16	63	123
E2516190	EQ516190	19.0	16	63	123
E2516901	EQ516901	20.0	16	75	135

Tolerances according to DIN 7160 & 7161

- ▶ Other shank design on your request.
- ▶ TiN and TiCN Coatings are available on your request.
- ▶ NEXT PAGE

Tolerance range in μm						
Nominal-Diameter in mm						
	from 1 to 3	over 3 to 6	over 6 to 10	over 10 to 18	over 18 to 30	over 30 to 50
e8	-14 -28	-20 -38	-25 -47	-32 -59	-40 -73	-50 -89
h6	0 -6	0 -8	0 -9	0 -11	0 -13	0 -16

◎ : Excellent ○ : Good

ISO Material Description	P											M			K						
	Non-alloy steel					Low alloy steel				High alloyed steel, and tool steel		Stainless steel			Grey cast iron		Nodular cast iron		Malleable cast iron		
VDI 3323	1	2	3	4	5	6	7	8	9	10	11	12	13	14	15	16	17	18	19	20	
HRc		13	25	28	32	10	29	32	38	15	35	15	23	10	10	26	3	25		21	
HB	125	190	250	270	300	180	275	300	350	200	325	200	240	180	180	260	160	250	130	230	
Recommend	◎	◎	◎	◎	◎	◎	◎	◎	◎	○	◎	◎	◎	◎	◎	◎	◎	◎	◎	◎	
ISO Material Description	N										S						H				
	Aluminum-wrought alloy		Aluminum-cast, alloyed			Copper and Copper Alloys (Bronze / Brass)			Non Metallic Materials		Heat Resistant Super Alloys						Titanium Alloys		Hardened steel	Chilled Cast Iron	Hardened Cast Iron
VDI 3323	21	22	23	24	25	26	27	28	29	30	31	32	33	34	35	36	37	38	39	40	41
HRc											15	30	25	38	34			55	60	42	55
HB	60	100	75	90	130	110	90	100			200	280	250	350	320	400 Rm	1050 Rm	550	630	400	550
Recommend	○	○	○	○	○																

HSSCo8, 3 FLUTE LONG LENGTH

- HSSCo8, 3 SCHNEIDEN LANG
- Fraise HSSCo8, 3 dents, longue
- 3 TAGLIANTI, SERIE LUNGA - HSSCo8

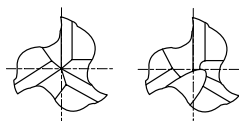

Up to Ø2.5mm Over Ø2.5mm

HSS Co8
DIN 844
3
30°
FLAT
P.750~757

Unit : mm

EDP No.		Mill Diameter	Shank Diameter	Length of Cut	Overall Length
UNCOATED	TiAlN	e8	h6		
E2516200	EQ516200	20.0	20	75	141
E2516220	EQ516220	22.0	20	75	141
E2516240	EQ516240	24.0	25	90	166
E2516250	EQ516250	25.0	25	90	166
E2516260	EQ516260	26.0	25	90	166
E2516280	EQ516280	28.0	25	90	166
E2516300	EQ516300	30.0	25	90	166
E2516320	EQ516320	32.0	32	106	186
E2516350	EQ516350	35.0	32	106	186
E2516360	EQ516360	36.0	32	106	186
E2516400	EQ516400	40.0	40	125	217

- ▶ Other shank design on your request.
- ▶ TiN and TiCN Coatings are available on your request.

Tolerances according to DIN 7160 & 7161

	Tolerance range in μm					
	Nominal-Diameter in mm					
	from 1 to 3	over 3 to 6	over 6 to 10	over 10 to 18	over 18 to 30	over 30 to 50
e8	-14 -28	-20 -38	-25 -47	-32 -59	-40 -73	-50 -89
h6	0 -6	0 -8	0 -9	0 -11	0 -13	0 -16

◎ : Excellent ○ : Good

ISO Material Description	P											M			K						
	Non-alloy steel					Low alloy steel				High alloyed steel, and tool steel		Stainless steel			Grey cast iron		Nodular cast iron		Malleable cast iron		
	1	2	3	4	5	6	7	8	9	10	11	12	13	14	15	16	17	18	19	20	
VDI 3323	1	2	3	4	5	6	7	8	9	10	11	12	13	14	15	16	17	18	19	20	
HRc	13	25	28	32	30	10	29	32	38	15	35	15	23	10	10	26	3	25	42	55	
HB	125	190	250	270	300	180	275	300	350	200	325	200	240	180	180	260	160	250	130	230	
Recommend	◎	◎	◎	◎	◎	◎	◎	◎	○	◎	○										
ISO Material Description	N					S					H										
	Aluminum-wrought alloy		Aluminum-cast, alloyed			Copper and Copper Alloys (Bronze / Brass)			Non Metallic Materials		Heat Resistant Super Alloys			Titanium Alloys		Hardened steel	Chilled Cast Iron	Hardened Cast Iron			
	21	22	23	24	25	26	27	28	29	30	31	32	33	34	35	36	37	38	39	40	41
VDI 3323	21	22	23	24	25	26	27	28	29	30	31	32	33	34	35	36	37	38	39	40	41
HRc	60	100	75	90	130	110	90	100			15	30	25	38	34	55	60	55	60	42	55
HB	60	100	75	90	130	110	90	100			200	280	250	350	320	400 Rm	1050 Rm	550	630	400	550
Recommend	○	○	○	○	○																

CBN END MILLS

i-Xmill END MILLS

i-SMART MODULAR END MILLS

X5070 END MILLS

4G MILL END MILLS

X-POWER PRO END MILLS

TitaNox-POWER END MILLS

JET-POWER END MILLS

V7 PLUS END MILLS

ALU-POWER HPC END MILLS

ALU-POWER END MILLS

D-POWER GRAPHITE END MILLS

D-POWER CFRP END MILLS

ROUTERS

CRX S END MILLS

K-2 END MILLS

ONLY ONE COATED PM60 END MILLS

TANK-POWER END MILLS

GENERAL HSS END MILLS

MILLING CUTTERS

TECHNICAL DATA



FLAT SHANK

E2553 SERIES

FLAT SHANK

EQ553 SERIES

HSSCo8, 3 FLUTE SHORT LENGTH THROW AWAY

- HSSCo8, 3 SCHNEIDEN KURZ EINWEGFRÄSER**
- Fraise HSSCo8, 3 dents à jeter, courte**
- 3 TAGLIENTI, SERIE CORTA NON RIAFFILABILE - HSSCo8**

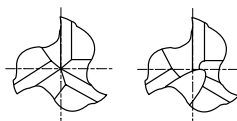

Up to Ø10mm Over Ø10mm

HSS Co8

YG STD

3

30°

FLAT

P.750~757

Unit : mm

EDP No.		Mill Diameter	Shank Diameter	Length of Cut	Overall Length
UNCOATED	TiAIN	e8	h6		
E2553010	EQ553010	1.0	6	2	34
E2553013	EQ553013	1.3	6	3	34
E2553015	EQ553015	1.5	6	3	34
E2553018	EQ553018	1.8	6	3	34
E2553020	EQ553020	2.0	6	4	35
E2553023	EQ553023	2.3	6	4	35
E2553025	EQ553025	2.5	6	5	36
E2553028	EQ553028	2.8	6	5	36
E2553030	EQ553030	3.0	6	5	36
E2553033	EQ553033	3.3	6	6	37
E2553035	EQ553035	3.5	6	6	37
E2553038	EQ553038	3.8	6	7	38
E2553040	EQ553040	4.0	6	7	38
E2553043	EQ553043	4.3	6	7	38
E2553045	EQ553045	4.5	6	7	38
E2553048	EQ553048	4.8	6	8	39
E2553050	EQ553050	5.0	6	8	39
E2553053	EQ553053	5.3	6	8	39
E2553055	EQ553055	5.5	6	8	39
E2553957	EQ553957	5.8	6	8	39
E2553060	EQ553060	6.0	6	8	39
E2553065	EQ553065	6.5	8	10	42
E2553070	EQ553070	7.0	8	10	42
E2553075	EQ553075	7.5	8	10	42

► TiN and TiCN Coatings are available on your request.

► NEXT PAGE

Tolerances according to DIN 7160 & 7161

Tolerance range in μm						
Nominal-Diameter in mm						
	from 1 to 3	over 3 to 6	over 6 to 10	over 10 to 18	over 18 to 30	over 30 to 50
e8	-14	-20	-25	-32	-40	-50
	-28	-38	-47	-59	-73	-89
h6	0	0	0	0	0	0
	-6	-8	-9	-11	-13	-16

◎ : Excellent ○ : Good

ISO Material Description	P											M			K						
	Non-alloy steel					Low alloy steel				High alloyed steel, and tool steel		Stainless steel			Grey cast iron		Nodular cast iron	Malleable cast iron			
VDI 3323	1	2	3	4	5	6	7	8	9	10	11	12	13	14	15	16	17	18	19	20	
HRc		13	25	28	32	10	29	32	38	15	35	15	23	10	10	26	3	25		21	
HB	125	190	250	270	300	180	275	300	350	200	325	200	240	180	180	260	160	250	130	230	
Recommend	◎	◎	◎	◎	◎	◎	◎	◎	◎	◎	◎	◎	◎	◎	◎	◎	◎	◎	◎	◎	
ISO Material Description	N										S					H					
	Aluminum-wrought alloy		Aluminum-cast, alloyed			Copper and Copper Alloys (Bronze / Brass)			Non Metallic Materials		Heat Resistant Super Alloys					Titanium Alloys		Hardened steel	Chilled Cast Iron	Hardened Cast Iron	
VDI 3323	21	22	23	24	25	26	27	28	29	30	31	32	33	34	35	36	37	38	39	40	41
HRc											15	30	25	38	34			55	60	42	55
HB	60	100	75	90	130	110	90	100			200	280	250	350	320	400 Rm	1050 Rm	550	630	400	550
Recommend	◎	◎	◎	◎	◎																

HSSCo8, 3 FLUTE SHORT LENGTH THROW AWAY

- HSSCo8, 3 SCHNEIDEN KURZ EINWEGFRÄSER
- Fraise HSSCo8, 3 dents à jeter, courte
- 3 TAGLIANTI, SERIE CORTA NON RIAFFILABILE - HSSCo8

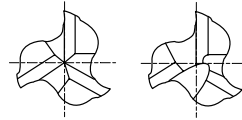
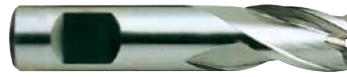

Up to Ø10mm Over Ø10mm

HSS Co8
YG STD
3
30°
FLAT
P.750~757

Unit : mm

EDP No.		Mill Diameter	Shank Diameter	Length of Cut	Overall Length
UNCOATED	TiAIN	e8	h6		
E2553080	EQ553080	8.0	8	11	43
E2553085	EQ553085	8.5	10	11	48
E2553090	EQ553090	9.0	10	11	48
E2553095	EQ553095	9.5	10	11	48
E2553100	EQ553100	10.0	10	13	50
E2553120	EQ553120	12.0	12	16	58
E2553160	EQ553160	16.0	16	19	64
E2553200	EQ553200	20.0	20	22	78

▶ TiN and TiCN Coatings are available on your request.

Tolerances according to DIN 7160 & 7161

	Tolerance range in μm					
	Nominal-Diameter in mm					
	from 1 to 3	over 3 to 6	over 6 to 10	over 10 to 18	over 18 to 30	over 30 to 50
e8	-14 -28	-20 -38	-25 -47	-32 -59	-40 -73	-50 -89
h6	0 -6	0 -8	0 -9	0 -11	0 -13	0 -16

SET ORDERING No.:
E2SET553
 * 12PCS. SET
 SHORT LENGTH
 - 2PCS. OF EACH SIZE
 2, 3, 4, 5, 6mm (C3FSC)
 - 1PC. OF EACH SIZE
 8, 10mm (C3FSC)

◎ : Excellent ○ : Good

ISO Material Description	P										M			K							
	Non-alloy steel					Low alloy steel					High alloyed steel, and tool steel			Stainless steel			Grey cast iron		Nodular cast iron		Malleable cast iron
VDI 3323	1	2	3	4	5	6	7	8	9	10	11	12	13	14	15	16	17	18	19	20	
HRC		13	25	28	32	10	29	32	38	15	35	15	23	10	10	26	3	25	42	55	
HB	125	190	250	270	300	180	275	300	350	200	325	200	240	180	180	260	160	250	130	230	
Recommend	◎	◎	◎	◎	◎	◎	◎	◎	○	◎	○										
ISO Material Description	N										S						H				
	Aluminum-wrought alloy		Aluminum-cast, alloyed			Copper and Copper Alloys (Bronze / Brass)			Non Metallic Materials		Heat Resistant Super Alloys						Titanium Alloys		Hardened steel	Chilled Cast Iron	Hardened Cast Iron
VDI 3323	21	22	23	24	25	26	27	28	29	30	31	32	33	34	35	36	37	38	39	40	41
HRC											15	30	25	38	34			55	60	42	55
HB	60	100	75	90	130	110	90	100			200	280	250	350	320	400 Rm	1050 Rm	550	630	400	550
Recommend	○	○	○	○	○																



FLAT SHANK

E2554 SERIES

FLAT SHANK

EQ554 SERIES

HSSCo8, 3 FLUTE LONG LENGTH THROW AWAY

- HSSCo8, 3 SCHNEIDEN LANG EINWEGFRÄSER**
- Fraise HSSCo8, 3 dents à jeter, longue**
- 3 TAGLIENTI, SERIE LUNGA, NON RIAFFILABILE - HSSCo8**

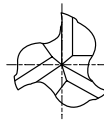

P.750~757

Unit : mm

EDP No.	Mill Diameter	Shank Diameter	Length of Cut	Overall Length	
					UNCOATED
E2554015	EQ554015	1.5	6	4	35
E2554020	EQ554020	2.0	6	7	38
E2554025	EQ554025	2.5	6	8	39
E2554030	EQ554030	3.0	6	8	39
E2554035	EQ554035	3.5	6	10	41
E2554040	EQ554040	4.0	6	11	42
E2554045	EQ554045	4.5	6	11	42
E2554050	EQ554050	5.0	6	13	44
E2554055	EQ554055	5.5	6	13	44
E2554060	EQ554060	6.0	6	13	44
E2554065	EQ554065	6.5	8	16	48
E2554070	EQ554070	7.0	8	16	48
E2554075	EQ554075	7.5	8	16	48
E2554080	EQ554080	8.0	8	19	51
E2554085	EQ554085	8.5	10	19	56
E2554090	EQ554090	9.0	10	19	56
E2554095	EQ554095	9.5	10	19	56
E2554100	EQ554100	10.0	10	22	59

► TiN and TiCN Coatings are available on your request.

Tolerances according to DIN 7160 & 7161

	Tolerance range in μm					
	Nominal-Diameter in mm					
	from 1 to 3	over 3 to 6	over 6 to 10	over 10 to 18	over 18 to 30	over 30 to 50
e8	-14	-20	-25	-32	-40	-50
	-28	-38	-47	-59	-73	-89
h6	0	0	0	0	0	0
	-6	-8	-9	-11	-13	-16

◎ : Excellent ○ : Good

ISO Material Description	P											M			K						
	Non-alloy steel					Low alloy steel				High alloyed steel, and tool steel		Stainless steel			Grey cast iron		Nodular cast iron	Malleable cast iron			
VDI 3323	1	2	3	4	5	6	7	8	9	10	11	12	13	14	15	16	17	18	19	20	
HRc		13	25	28	32	10	29	32	38	15	35	15	23	10	10	26	3	25		21	
HB	125	190	250	270	300	180	275	300	350	200	325	200	240	180	180	260	160	250	130	230	
Recommend	◎	◎	◎	◎	◎	◎	◎	◎	◎	○	◎	○									
ISO Material Description	N										S					H					
	Aluminum-wrought alloy		Aluminum-cast, alloyed			Copper and Copper Alloys (Bronze / Brass)			Non Metallic Materials		Heat Resistant Super Alloys					Titanium Alloys		Hardened steel	Chilled Cast Iron	Hardened Cast Iron	
VDI 3323	21	22	23	24	25	26	27	28	29	30	31	32	33	34	35	36	37	38	39	40	41
HRc											15	30	25	38	34			55	60	42	55
HB	60	100	75	90	130	110	90	100			200	280	250	350	320	400 Rm	1050 Rm	550	630	400	550
Recommend	○	○	○	○	○																

HSSCo8, 3 FLUTE SHORT LENGTH THROW AWAY

- HSSCo8, 3 SCHNEIDEN KURZ EINWEGFRÄSER
- Fraise HSSCo8, 3 dent à jeter, courte
- 3 TAGLIANTI, SERIE CORTA NON RIAFFILABILE - HSSCo8



HSS Co8
YG STD
3
30°
FLAT
P.750~757

EDP No.		Mill Diameter	Shank Diameter	Length of Cut	Overall Length
UNCOATED	TiAIN	e8			
▲ E2551010	-	1.0	6	2	24.5
▲ E2551015	-	1.5	6	2.5	24.5
▲ E2551020	▲ EQ551020	2.0	6	3	25.5
▲ E2551025	-	2.5	6	4	26
▲ E2551028	-	2.8	6	4.5	28
▲ E2551030	▲ EQ551030	3.0	6	4.5	28
▲ E2551035	▲ EQ551035	3.5	6	5.5	30
▲ E2551040	▲ EQ551040	4.0	6	6.5	32.5
▲ E2551045	-	4.5	6	7	34.5
▲ E2551048	-	4.8	6	7.5	36
▲ E2551050	-	5.0	6	7.5	36
▲ E2551055	-	5.5	6	8.5	36
▲ E2551957	-	5.8	6	9.5	36
▲ E2551060	-	6.0	6	9.5	36
▲ E2551075	▲ EQ551075	7.5	10	11	47.5
▲ E2551080	-	8.0	10	11	47.5
▲ E2551095	-	9.5	10	13	51.5
▲ E2551100	-	10.0	10	13	51.5

▲ : Only available till stock runs out
 ► TiN and TiCN Coatings are available on your request.

Tolerances according to DIN 7160 & 7161

	Tolerance range in μm					
	Nominal-Diameter in mm					
	from 1 to 3	over 3 to 6	over 6 to 10	over 10 to 18	over 18 to 30	over 30 to 50
e8	-14 -28	-20 -38	-25 -47	-32 -59	-40 -73	-50 -89
h6	0 -6	0 -8	0 -9	0 -11	0 -13	0 -16

Shank Dia. Tolerance	
up to $\varnothing 6$	-0.018 -0.025
over $\varnothing 6$	h6

◎ : Excellent ○ : Good

ISO Material Description	P											M			K					
	Non-alloy steel					Low alloy steel				High alloyed steel, and tool steel		Stainless steel			Grey cast iron		Nodular cast iron		Malleable cast iron	
VDI 3323	1	2	3	4	5	6	7	8	9	10	11	12	13	14	15	16	17	18	19	20
HRC	13	25	28	32	10	29	32	38	15	35	15	23	10	10	26	3	25	42	55	
HB	125	190	250	270	300	180	275	300	350	200	325	200	240	180	180	260	160	250	130	230
Recommend	◎	◎	◎	◎	◎	◎	◎	◎	○	◎	◎	◎	◎	◎	◎	◎	◎	◎	◎	

ISO Material Description	N					S					H											
	Aluminum-wrought alloy		Aluminum-cast, alloyed		Copper and Copper Alloys (Bronze / Brass)	Non Metallic Materials	Heat Resistant Super Alloys			Titanium Alloys		Hardened steel	Chilled Cast Iron	Hardened Cast Iron								
VDI 3323	21	22	23	24	25	26	27	28	29	30	31	32	33	34	35	36	37	38	39	40	41	
HRC	60	100	75	90	130	110	90	100				15	30	25	38	34	55	60	55	60	42	55
HB	60	100	75	90	130	110	90	100				200	280	250	350	320	400 Rm	1050 Rm	550	630	400	550
Recommend	○	○	○	○	○																	



FLAT SHANK

E2552 SERIES

FLAT SHANK

EQ552 SERIES

HSSCo8, 3 FLUTE LONG LENGTH THROW AWAY

- HSSCo8, 3 SCHNEIDEN LANG EINWEGFRÄSER
- Fraise HSSCo8, 3 dents à jeter, longue
- 3 TAGLIENTI, SERIE CORTA NON RIAFFILABILE - HSSCo8



HSS Co8
YG STD
3
30°
FLAT
P.750~757

Unit : mm

	EDP No.		Mill Diameter	Shank Diameter	Length of Cut	Overall Length
	UNCOATED	TiAIN	e8			
▲ E2552015	▲ EQ552015		1.5	6	4	28
▲ E2552020	-		2.0	6	4.5	29
▲ E2552025	-		2.5	6	6.5	32
▲ E2552030	-		3.0	6	7.5	34
▲ E2552035	▲ EQ552035		3.5	6	8.5	36.5
▲ E2552040	▲ EQ552040		4.0	6	9.5	39
▲ E2552045	▲ EQ552045		4.5	6	11	42
▲ E2552050	▲ EQ552050		5.0	6	12.5	44.5
▲ E2552055	▲ EQ552055		5.5	6	14.5	46
▲ E2552060	▲ EQ552060		6.0	6	16	44.5
▲ E2552080	▲ EQ552080		8.0	10	19	55.5
▲ E2552090	▲ EQ552090		9.0	10	22.5	61
▲ E2552100	▲ EQ552100		10.0	10	22.5	61

- ▲ : Only available till stock runs out
- ▶ TiN and TiCN Coatings are available on your request.

Tolerances according to DIN 7160 & 7161

	Tolerance range in μm						Shank Dia. Tolerance	
	Nominal-Diameter in mm						up to $\varnothing 6$	- 0.018 - 0.025
	from 1 to 3	over 3 to 6	over 6 to 10	over 10 to 18	over 18 to 30	over 30 to 50	over $\varnothing 6$	h6
e8	-14 -28	-20 -38	-25 -47	-32 -59	-40 -73	-50 -89		
h6	0 -6	0 -8	0 -9	0 -11	0 -13	0 -16		

◎ : Excellent ○ : Good

ISO Material Description	P											M			K						
	Non-alloy steel					Low alloy steel				High alloyed steel, and tool steel		Stainless steel			Grey cast iron		Nodular cast iron		Malleable cast iron		
VDI 3323	1	2	3	4	5	6	7	8	9	10	11	12	13	14	15	16	17	18	19	20	
HRc	13	25	28	32	10	29	32	38	15	35	15	23	10	10	26	3	25				
HB	125	190	250	270	300	180	275	300	350	200	325	200	240	180	180	260	160	250	130	230	
Recommend	◎	◎	◎	◎	◎	◎	◎	◎	○	◎	○										
ISO Material Description	N										S					H					
	Aluminum-wrought alloy		Aluminum-cast, alloyed			Copper and Copper Alloys (Bronze / Brass)			Non Metallic Materials		Heat Resistant Super Alloys					Titanium Alloys		Hardened steel	Chilled Cast Iron	Hardened Cast Iron	
VDI 3323	21	22	23	24	25	26	27	28	29	30	31	32	33	34	35	36	37	38	39	40	41
HRc											15	30	25	38	34			55	60	42	55
HB	60	100	75	90	130	110	90	100			200	280	250	350	320	400 Rm	1050 Rm	550	630	400	550
Recommend	○	○	○	○	○																

HSSCo8, 4&6 FLUTE SHORT LENGTH

- HSSCo8, 4&6 SCHNEIDEN KURZ
- Fraise HSSCo8, 4&6 dents, courte
- HSSCo8, 4&6 TAGLIENTI, SERIE CORTA



Under Ø3mm : Center cut type

HSS Co8
DIN 844
4&6
≈ 30°
DIN 1835B
P.758~761

Unit : mm

EDP No.		Mill Diameter	Shank Diameter	Length of Cut	Overall Length	No. of Flute
UNCOATED	TiAIN					
E2574020	EQ574020	2.0	6	7	51	4
E2574025	EQ574025	2.5	6	8	52	4
E2574030	EQ574030	3.0	6	8	52	4
E2574035	EQ574035	3.5	6	10	54	4
E2574040	EQ574040	4.0	6	11	55	4
E2574050	EQ574050	5.0	6	13	57	4
E2574060	EQ574060	6.0	6	13	57	4
E2574070	EQ574070	7.0	10	16	66	4
E2574080	EQ574080	8.0	10	19	69	4
E2574090	EQ574090	9.0	10	19	69	4
E2574100	EQ574100	10.0	10	22	72	4
E2574110	EQ574110	11.0	12	22	79	4
E2574120	EQ574120	12.0	12	26	83	4
E2574130	EQ574130	13.0	12	26	83	4
E2574140	EQ574140	14.0	12	26	83	4
E2574150	EQ574150	15.0	12	26	83	4
E2574160	EQ574160	16.0	16	32	92	4
E2574170	EQ574170	17.0	16	32	92	4
E2574180	EQ574180	18.0	16	32	92	4
E2574190	EQ574190	19.0	16	32	92	4
E2574200	EQ574200	20.0	20	38	104	4
▲ E2575210	-	21.0	20	38	104	6
▲ E2575220	-	22.0	20	38	104	6
▲ E2575230	-	23.0	20	38	104	6
▲ E2575240	-	24.0	25	45	121	6
▲ E2575250	▲ EQ575250	25.0	25	45	121	6
▲ E2575260	-	26.0	25	45	121	6
▲ E2575300	▲ EQ575300	30.0	25	45	121	6
▲ E2575320	-	32.0	32	53	133	6
▲ E2575400	-	40.0	32	63	143	6

Mill Dia. Tolerance (mm)	Shank Dia. Tolerance
0 ~ + 0.04	h6

- ▲ : Only available till stock runs out
- ▶ Other shank design on your request.
- ▶ TiN and TiCN Coatings are available on your request.

◎ : Excellent ○ : Good

ISO Material Description	P										M			K							
	Non-alloy steel					Low alloy steel					High alloyed steel, and tool steel			Stainless steel			Grey cast iron		Nodular cast iron		Malleable cast iron
VDI 3323	1	2	3	4	5	6	7	8	9	10	11	12	13	14	15	16	17	18	19	20	
HRC	13	25	28	32	10	29	32	38	15	35	15	23	10	10	26	3	25	21	21		
HB	125	190	250	270	300	180	275	300	350	200	325	200	240	180	180	260	160	250	130	230	
Recommend	◎	◎	◎	◎	◎	◎	◎	◎	○	◎	○	◎	◎	◎	◎	◎	◎	◎	◎	◎	

ISO Material Description	N					S					H										
	Aluminum-wrought alloy		Aluminum-cast, alloyed		Copper and Copper Alloys (Bronze / Brass)		Non Metallic Materials		Heat Resistant Super Alloys			Titanium Alloys		Hardened steel	Chilled Cast Iron	Hardened Cast Iron					
VDI 3323	21	22	23	24	25	26	27	28	29	30	31	32	33	34	35	36	37	38	39	40	41
HRC	60	100	75	90	130	110	90	100			15	30	25	38	34	55	60	42	55	55	55
HB	60	100	75	90	130	110	90	100			200	280	250	350	320	400 Rm	1050 Rm	550	630	400	550
Recommend	○	○	○	○	○						◎	◎	◎	◎	◎	◎	◎	◎	◎	◎	◎



FLAT SHANK

E2595 SERIES

FLAT SHANK

EQ595 SERIES

HSSCo8, 4 FLUTE SHORT LENGTH - CENTER CUTTING

- **HSSCo8, 4&6 SCHNEIDEN KURZ**
- **Fraise HSSCo8, 4&6 dents, coupe au centre, courte**
- **4 - 6 TAGLIENTI, SERIE CORTA, TAGLIENTE AL CENTRO - HSSCo8**

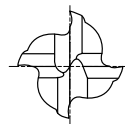

HSS Co8

DIN 844

4

≈ 30°

DIN 1835B

P.772~775

Unit : mm

EDP No.	Mill Diameter	Shank Diameter	Length of Cut	Overall Length	
					UNCOATED
E2595020	EQ595020	2.0	6	7	51
E2595030	EQ595030	3.0	6	8	52
E2595040	EQ595040	4.0	6	11	55
E2595050	EQ595050	5.0	6	13	57
E2595060	EQ595060	6.0	6	13	57
E2595070	EQ595070	7.0	10	16	66
E2595080	EQ595080	8.0	10	19	69
E2595090	EQ595090	9.0	10	19	69
E2595100	EQ595100	10.0	10	22	72
E2595110	EQ595110	11.0	12	22	79
E2595120	EQ595120	12.0	12	26	83
E2595130	EQ595130	13.0	12	26	83
E2595140	EQ595140	14.0	12	26	83
E2595150	EQ595150	15.0	12	26	83
E2595160	EQ595160	16.0	16	32	92
E2595170	EQ595170	17.0	16	32	92
E2595180	EQ595180	18.0	16	32	92
E2595190	EQ595190	19.0	16	32	92
E2595920	EQ595920	20.0	16	38	98
E2595200	EQ595200	20.0	20	38	104
E2595220	EQ595220	22.0	20	38	104
E2595250	EQ595250	25.0	25	45	121

- ▶ Other shank design on your request.
- ▶ TiN and TiCN Coatings are available on your request.

Mill Dia. Tolerance (mm)	Shank Dia. Tolerance
0 ~ + 0.04	h6

◎ : Excellent ○ : Good

ISO Material Description	P											M			K						
	Non-alloy steel					Low alloy steel				High alloyed steel, and tool steel		Stainless steel			Grey cast iron		Nodular cast iron	Malleable cast iron			
VDI 3323	1	2	3	4	5	6	7	8	9	10	11	12	13	14	15	16	17	18	19	20	
HRc		13	25	28	32	10	29	32	38	15	35	15	23	10	10	26	3	25			
HB	125	190	250	270	300	180	275	300	350	200	325	200	240	180	180	260	160	250	130	230	
Recommend	◎	◎	◎	◎	◎	◎	◎	◎	◎	◎	◎	◎	◎	◎	◎	◎	◎	◎	◎	◎	
ISO Material Description	N										S					H					
	Aluminum-wrought alloy		Aluminum-cast, alloyed			Copper and Copper Alloys (Bronze / Brass)			Non Metallic Materials		Heat Resistant Super Alloys					Titanium Alloys		Hardened steel	Chilled Cast Iron	Hardened Cast Iron	
VDI 3323	21	22	23	24	25	26	27	28	29	30	31	32	33	34	35	36	37	38	39	40	41
HRc											15	30	25	38	34			55	60	42	55
HB	60	100	75	90	130	110	90	100			200	280	250	350	320	400 Rm	1050 Rm	550	630	400	550
Recommend	◎	◎	◎	◎	◎																

HSSCo8, 6 FLUTE SHORT LENGTH - CENTER CUTTING

- HSSCo8, 4&6 SCHNEIDEN KURZ
- Fraise HSSCo8, 4&6 dents, coupe au centre, courte
- 4 - 6 TAGLIENTI, SERIE CORTA, TAGLIENTE AL CENTRO - HSSCo8



EDP No.		Mill Diameter	Shank Diameter	Length of Cut	Overall Length
UNCOATED	TiAIN				
▲ E2596220	▲ EQ596220	22.0	20	38	104
▲ E2596240	▲ EQ596240	24.0	25	45	121
▲ E2596250	▲ EQ596250	25.0	25	45	121
▲ E2596260	▲ EQ596260	26.0	25	45	121
▲ E2596280	▲ EQ596280	28.0	25	45	121
▲ E2596300	▲ EQ596300	30.0	25	45	121
▲ E2596320	▲ EQ596320	32.0	32	53	133
▲ E2596340	▲ EQ596340	34.0	32	53	133
▲ E2596350	▲ EQ596350	35.0	32	53	133
-	▲ EQ596360	36.0	32	53	133
▲ E2596380	-	38.0	32	63	143
▲ E2596901	▲ EQ596901	40.0	32	63	143
▲ E2596400	▲ EQ596400	40.0	40	63	155

- ▲ : Only available till stock runs out
- ▶ Other shank design on your request.
- ▶ TiN and TiCN Coatings are available on your request.

Mill Dia. Tolerance (mm)	Shank Dia. Tolerance
0 ~ + 0.04	h6

ISO Material Description	P											M			K							
	Non-alloy steel					Low alloy steel						High alloyed steel, and tool steel			Stainless steel			Grey cast iron		Nodular cast iron		Malleable cast iron
VDI 3323	1	2	3	4	5	6	7	8	9	10	11	12	13	14	15	16	17	18	19	20		
HRc	13	25	28	32	10	29	32	38	15	35	15	23	10	10	26	3	25	21	21			
HB	125	190	250	270	300	180	275	300	350	200	325	200	240	180	180	260	160	250	130	230		
Recommend	◎	◎	◎	◎	◎	◎	◎	◎	○	◎	○											

ISO Material Description	N					S					H										
	Aluminum-wrought alloy		Aluminum-cast, alloyed			Copper and Copper Alloys (Bronze / Brass)			Non Metallic Materials		Heat Resistant Super Alloys			Titanium Alloys		Hardened steel	Chilled Cast Iron	Hardened Cast Iron			
VDI 3323	21	22	23	24	25	26	27	28	29	30	31	32	33	34	35	36	37	38	39	40	41
HRc	60	100	75	90	130	110	90	100			15	30	25	38	34	55	60	42	55	55	55
HB	60	100	75	90	130	110	90	100			200	280	250	350	320	400 Rm	1050 Rm	550	630	400	550
Recommend	○	○	○	○	○																

◎ : Excellent ○ : Good



FLAT SHANK **E2576, EQ576** SERIES

FLAT SHANK **E2577, EQ577** SERIES

HSSCo8, 4&6 FLUTE LONG LENGTH

- HSSCo8, 4&6 SCHNEIDEN LANG
- Fraise HSSCo8, 4&6 dents, longue
- HSSCo8, 4&6 TAGLIENTI, SERIE LUNGA



Under Ø3mm : Center cut type

HSS Co8
DIN 844
4&6
30°
DIN 1835B
P.758~761

Unit : mm

EDP No.	Mill Diameter	Shank Diameter	Length of Cut	Overall Length	No. of Flute	
						UNCOATED
-	▲ EQ576020	2.0	6	10	54	4
▲ E2576030	-	3.0	6	12	56	4
▲ E2576040	-	4.0	6	19	63	4
▲ E2576045	-	4.5	6	19	63	4
▲ E2576050	▲ EQ576050	5.0	6	24	68	4
▲ E2576060	-	6.0	6	24	68	4
▲ E2576070	-	7.0	10	30	80	4
▲ E2576080	-	8.0	10	38	88	4
▲ E2576090	-	9.0	10	38	88	4
▲ E2576100	▲ EQ576100	10.0	10	45	95	4
▲ E2576110	-	11.0	12	45	102	4
▲ E2576120	-	12.0	12	53	110	4
▲ E2576130	-	13.0	12	53	110	4
▲ E2576140	-	14.0	12	53	110	4
▲ E2576160	-	16.0	16	63	123	4
▲ E2576180	▲ EQ576180	18.0	16	63	123	4
▲ E2576902	-	20.0	16	75	135	4
▲ E2576200	-	20.0	20	75	141	4
▲ E2577220	-	22.0	20	75	141	6
▲ E2577240	-	24.0	25	90	166	6
▲ E2577250	▲ EQ577250	25.0	25	90	166	6
▲ E2577320	-	32.0	32	106	186	6
▲ E2577400	▲ EQ577400	40.0	40	125	217	6

- ▲ : Only available till stock runs out
- ▶ Other shank design on your request.
- ▶ TiN and TiCN Coatings are available on your request.

Mill Dia. Tolerance(mm)	Shank Dia. Tolerance
up to Ø6	0 ~ + 0.04
over Ø6	0 ~ + 0.05

h6

◎ : Excellent ○ : Good

ISO Material Description	P										M			K							
	Non-alloy steel					Low alloy steel					High alloyed steel, and tool steel			Stainless steel			Grey cast iron		Nodular cast iron		Malleable cast iron
VDI 3323	1	2	3	4	5	6	7	8	9	10	11	12	13	14	15	16	17	18	19	20	
HRc		13	25	28	32	10	29	32	38	15	35	15	23	10	10	26	3	25		21	
HB	125	190	250	270	300	180	275	300	350	200	325	200	240	180	180	260	160	250	130	230	
Recommend	◎	◎	◎	◎	◎	◎	◎	◎	◎	◎	◎	◎	◎	◎	◎	◎	◎	◎	◎	◎	

ISO Material Description	N										S							H			
	Aluminum-wrought alloy		Aluminum-cast, alloyed			Copper and Copper Alloys (Bronze / Brass)			Non Metallic Materials		Heat Resistant Super Alloys					Titanium Alloys		Hardened steel	Chilled Cast Iron	Hardened Cast Iron	
VDI 3323	21	22	23	24	25	26	27	28	29	30	31	32	33	34	35	36	37	38	39	40	41
HRc											15	30	25	38	34			55	60	42	55
HB	60	100	75	90	130	110	90	100			200	280	250	350	320	400 Rm	1050 Rm	550	630	400	550
Recommend	○	○	○	○	○						◎	◎	◎	◎	◎	◎	◎	◎	◎	◎	◎

HSSCo8, 4 FLUTE LONG LENGTH - CENTER CUTTING

- HSSCo8, 4&6 SCHNEIDEN LANG
- Fraise HSSCo8, 4&6 dents, coupe au centre, longue
- 4&6 TAGLIANTI, SERIE LUNGA, TAGLIENTE AL CENTRO - HSSCo8

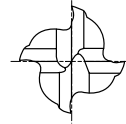

HSS Co8
DIN 844
4
≈ 30°
DIN 1835B
P.758~761

Unit : mm

EDP No.		Mill Diameter	Shank Diameter	Length of Cut	Overall Length
UNCOATED	TiAIN				
E2597020	EQ597020	2.0	6	10	54
E2597025	EQ597025	2.5	6	12	56
E2597030	EQ597030	3.0	6	12	56
E2597035	EQ597035	3.5	6	15	59
E2597040	EQ597040	4.0	6	19	63
E2597045	EQ597045	4.5	6	19	63
E2597050	EQ597050	5.0	6	24	68
E2597055	EQ597055	5.5	6	24	68
E2597060	EQ597060	6.0	6	24	68
E2597070	EQ597070	7.0	10	30	80
E2597080	EQ597080	8.0	10	38	88
E2597090	EQ597090	9.0	10	38	88
E2597100	EQ597100	10.0	10	45	95
E2597110	EQ597110	11.0	12	45	102
E2597120	EQ597120	12.0	12	53	110
E2597130	EQ597130	13.0	12	53	110
E2597140	EQ597140	14.0	12	53	110
E2597150	EQ597150	15.0	12	53	110
E2597160	EQ597160	16.0	16	63	123
E2597170	EQ597170	17.0	16	63	123
E2597180	EQ597180	18.0	16	63	123
E2597190	EQ597190	19.0	16	63	123
E2597200	EQ597200	20.0	20	75	141

- ▶ Other shank design on your request.
- ▶ TiN and TiCN Coatings are available on your request.

Mill Dia. Tolerance(mm)		Shank Dia. Tolerance
up to Ø6	0 ~ + 0.04	
over Ø6	0 ~ + 0.05	

◎ : Excellent ○ : Good

ISO Material Description	P											M			K					
	Non-alloy steel					Low alloy steel				High alloyed steel, and tool steel		Stainless steel			Grey cast iron		Nodular cast iron		Malleable cast iron	
VDI 3323	1	2	3	4	5	6	7	8	9	10	11	12	13	14	15	16	17	18	19	20
HRc		13	25	28	32	10	29	32	38	15	35	15	23	10	10	26	3	25	42	55
HB	125	190	250	270	300	180	275	300	350	200	325	200	240	180	180	260	160	250	130	230
Recommend	◎	◎	◎	◎	◎	◎	◎	◎	○	◎	○									

ISO Material Description	N					S					H										
	Aluminum-wrought alloy		Aluminum-cast, alloyed		Copper and Copper Alloys (Bronze / Brass)	Non Metallic Materials	Heat Resistant Super Alloys			Titanium Alloys		Hardened steel	Chilled Cast Iron	Hardened Cast Iron							
VDI 3323	21	22	23	24	25	26	27	28	29	30	31	32	33	34	35	36	37	38	39	40	41
HRc											15	30	25	38	34	55	60	55	60	42	55
HB	60	100	75	90	130	110	90	100			200	280	250	350	320	400 Rm	1050 Rm	550	630	400	550
Recommend	○	○	○	○	○																



FLAT SHANK

E2598 SERIES

FLAT SHANK

EQ598 SERIES

HSSCo8, 6 FLUTE LONG LENGTH - CENTER CUTTING

- **HSSCo8, 4&6 SCHNEIDEN LANG**
- **Fraise HSSCo8, 4&6 dents, coupe au centre, longue**
- **4&6 TAGLIENTI, SERIE LUNGA, TAGLIENTE AL CENTRO - HSSCo8**



HSS Co8
DIN 844
6
≈ 30°
DIN 1835B
✂
▨
P.758~761

Unit : mm

EDP No.		Mill Diameter	Shank Diameter	Length of Cut	Overall Length
UNCOATED	TiAIN				
E2598220	EQ598220	22.0	20	75	141
E2598240	EQ598240	24.0	25	90	166
E2598250	EQ598250	25.0	25	90	166
E2598260	EQ598260	26.0	25	90	166
E2598280	EQ598280	28.0	25	90	166
E2598300	EQ598300	30.0	25	90	166
E2598320	EQ598320	32.0	32	106	186
E2598360	EQ598360	36.0	32	106	186
E2598400	EQ598400	40.0	40	125	217

- ▶ Other shank design on your request.
- ▶ TiN and TiCN Coatings are available on your request.

Mill Dia. Tolerance(mm)	Shank Dia. Tolerance
0 ~ + 0.05	h6

◎ : Excellent ○ : Good

ISO Material Description	P											M			K						
	Non-alloy steel					Low alloy steel						High alloyed steel, and tool steel			Stainless steel			Grey cast iron		Nodular cast iron	
VDI 3323	1	2	3	4	5	6	7	8	9	10	11	12	13	14	15	16	17	18	19	20	
HRc		13	25	28	32	10	29	32	38	15	35	15	23	10	10	26	3	25		21	
HB	125	190	250	270	300	180	275	300	350	200	325	200	240	180	180	260	160	250	130	230	
Recommend	◎	◎	◎	◎	◎	◎	◎	◎	○	◎	○										

ISO Material Description	N										S							H			
	Aluminum-wrought alloy		Aluminum-cast, alloyed			Copper and Copper Alloys (Bronze / Brass)			Non Metallic Materials		Heat Resistant Super Alloys							Titanium Alloys		Hardened steel	Chilled Cast Iron
VDI 3323	21	22	23	24	25	26	27	28	29	30	31	32	33	34	35	36	37	38	39	40	41
HRc											15	30	25	38	34			55	60	42	55
HB	60	100	75	90	130	110	90	100			200	280	250	350	320	400 Rm	1050 Rm	550	630	400	550
Recommend	○	○	○	○	○																

HSSCo8, MULTI FLUTE SHORT LENGTH

- HSSCo8, MULTI SCHNEIDEN KURZ
- Fraise HSSCo8, multi-dents, courte
- MULTI TAGLIENTE, SERIE CORTA - HSSCo8

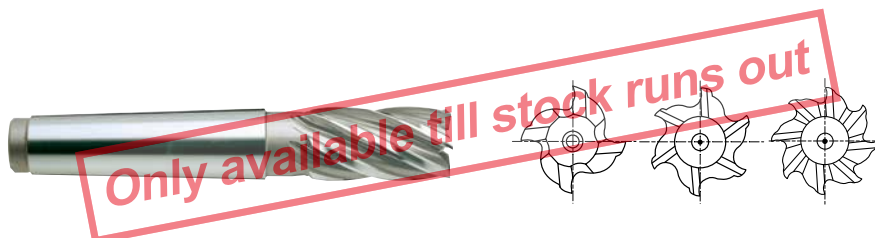

P.758~761

Unit : mm

EDP No.		Mill Diameter	Length of Cut	Overall Length	Morse Taper No.	No. of Flute
UNCOATED	TiAIN					
▲ E2776140	-	14.0	26	111	2	4
▲ E2776160	-	16.0	32	117	2	4
▲ E2776180	▲ EQ776180	18.0	32	117	2	4
▲ E2776200	▲ EQ776200	20.0	38	123	2	4
▲ E2776220	▲ EQ776220	22.0	38	123	2	6
▲ E2776240	-	24.0	45	147	3	6
▲ E2776250	-	25.0	45	147	3	6
▲ E2776260	-	26.0	45	147	3	6
▲ E2776280	▲ EQ776280	28.0	45	147	3	6
▲ E2776300	-	30.0	45	147	3	6
▲ E2776320	-	32.0	53	178	4	6
▲ E2776350	-	35.0	53	178	4	6
▲ E2776360	-	36.0	53	178	4	6
▲ E2776380	-	38.0	63	188	4	6
▲ E2776400	-	40.0	63	188	4	6
-	▲ EQ776420	42.0	63	188	4	6
▲ E2776440	▲ EQ776440	44.0	63	188	4	6
▲ E2776450	▲ EQ776450	45.0	63	188	4	8
▲ E2776500	-	50.0	75	233	5	8

- ▲ : Only available till stock runs out
- ▶ Other shank design on your request.
- ▶ TiN and TiCN Coatings are available on your request.

Mill Dia.
Tolerance(mm)
±0.120

◎ : Excellent ○ : Good

ISO Material Description	P											M			K					
	Non-alloy steel					Low alloy steel				High alloyed steel, and tool steel		Stainless steel			Grey cast iron		Nodular cast iron		Malleable cast iron	
VDI 3323	1	2	3	4	5	6	7	8	9	10	11	12	13	14	15	16	17	18	19	20
HRC																				
HB	125	190	250	270	300	180	275	300	350	200	325	200	240	180	180	260	160	250	130	230
Recommend	◎	◎	◎	◎	◎	◎	◎	◎	○	◎	◎	◎	◎	◎	◎	◎	◎	◎	◎	◎

ISO Material Description	N					S					H										
	Aluminum-wrought alloy		Aluminum-cast, alloyed		Copper and Copper Alloys (Bronze / Brass)	Non Metallic Materials	Heat Resistant Super Alloys			Titanium Alloys		Hardened steel	Chilled Cast Iron	Hardened Cast Iron							
VDI 3323	21	22	23	24	25	26	27	28	29	30	31	32	33	34	35	36	37	38	39	40	41
HRC																					
HB	60	100	75	90	130	110	90	100			200	280	250	350	320	400 Rm	1050 Rm	550	630	400	550
Recommend	○	○	○	○	○																



FLAT SHANK **E2461, E2462, E2463** SERIES
 FLAT SHANK **EQ461, EQ462** SERIES

HSSCo8, MULTI FLUTE 50° HELIX SHORT LENGTH

- **HSSCo8, MULTI SCHNEIDEN 50° RECHTSSPIRALE KURZ**
- **Fraise HSSCo8, multi-dents, hélice 50°, courte**
- **MULTI TAGLIENTE, ELICA 50°, SERIE CORTA - HSSCo8**



HSS Co8
DIN 844
2-4
50°
DIN 1835B
P.762~763

Unit : mm

	EDP No.		Mill Diameter	Shank Diameter	Length of Cut	Overall Length	No. of Flute
	UNCOATED	TiAIN					
▲ E2461020	-	-	2.0	6	7	51	2
▲ E2461030	▲ EQ461030	-	3.0	6	8	52	2
▲ E2461040	-	-	4.0	6	11	55	2
▲ E2461050	-	-	5.0	6	13	57	2
▲ E2462060	-	-	6.0	6	13	57	3
▲ E2462070	-	-	7.0	10	16	66	3
▲ E2462080	▲ EQ462080	-	8.0	10	19	69	3
▲ E2462090	-	-	9.0	10	19	69	3
▲ E2462100	-	-	10.0	10	22	72	3
▲ E2462110	▲ EQ462110	-	11.0	12	22	79	3
▲ E2462120	▲ EQ462120	-	12.0	12	26	83	3
▲ E2462130	-	-	13.0	12	26	83	3
▲ E2462140	▲ EQ462140	-	14.0	12	26	83	3
▲ E2462150	▲ EQ462150	-	15.0	12	26	83	3
▲ E2462160	-	-	16.0	16	32	92	3
▲ E2462180	-	-	18.0	16	32	92	3
▲ E2462200	-	-	20.0	20	38	104	3
▲ E2462230	-	-	23.0	20	38	104	3
▲ E2463220	-	-	22.0	25	45	121	4
▲ E2463250	-	-	25.0	25	45	121	4
▲ E2463300	-	-	30.0	25	45	121	4

- ▲ : Only available till stock runs out
- ▶ Other shank design on your request.
- ▶ TiN and TiCN Coatings are available on your request.

Mill Dia. Tolerance(mm)	Shank Dia. Tolerance
up to Ø3.0	0 ~ + 0.04
Ø4.0 ~ Ø6.0	0 ~ + 0.048
Ø7.0 ~ Ø10.0	0 ~ + 0.058
Ø10.5 ~ Ø18.0	0 ~ + 0.07
over Ø18.0	0 ~ + 0.084

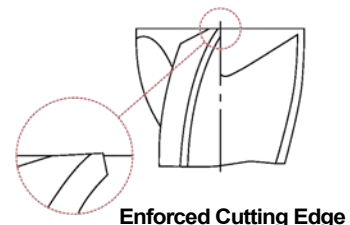

◎ : Excellent ○ : Good

ISO Material Description	P											M			K					
	Non-alloy steel					Low alloy steel				High alloyed steel, and tool steel		Stainless steel			Grey cast iron		Nodular cast iron	Malleable cast iron		
VDI 3323	1	2	3	4	5	6	7	8	9	10	11	12	13	14	15	16	17	18	19	20
HRc		13	25	28	32	10	29	32	38	15	35	15	23	10	10	26	3	25		21
HB	125	190	250	270	300	180	275	300	350	200	325	200	240	180	180	260	160	250	130	230
Recommend	◎	◎	◎	◎	◎	◎	◎	◎	◎	○	◎	◎	◎	◎	◎	◎	◎	◎	◎	◎

ISO Material Description	N										S							H			
	Aluminum-wrought alloy		Aluminum-cast, alloyed			Copper and Copper Alloys (Bronze / Brass)			Non Metallic Materials		Heat Resistant Super Alloys					Titanium Alloys		Hardened steel	Chilled Cast Iron	Hardened Cast Iron	
VDI 3323	21	22	23	24	25	26	27	28	29	30	31	32	33	34	35	36	37	38	39	40	41
HRc											15	30	25	38	34			55	60	42	55
HB	60	100	75	90	130	110	90	100			200	280	250	350	320	400 Rm	1050 Rm	550	630	400	550
Recommend																					

HSSCo8, MULTI FLUTE SHORT LENGTH ROUGHING - EXTRA FINE

- HSSCo8, MULTI SCHNEIDEN KURZ SCHRUPPFRÄSER - EXTRA FEIN
- Fraise HSSCo8, multi-dents ébauche, pas extra-fin, courte
- MULTI TAGLIENTE, PER SGROSSATURA, SERIE CORTA, BOMBATO FINE - HSSCo8

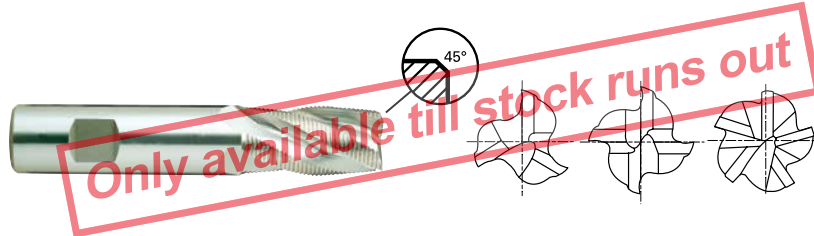

HSS Co8
DIN 844
HR
3-5
30°
DIN 1835B
C x 45°
P.764~767

Unit : mm

EDP No.		Mill Diameter	Shank Diameter	Length of Cut	Overall Length	No. of Flute	Chamfer
UNCOATED	TiAIN	js12	h6				
▲ E2761060	▲ EQ761060	6.0	6	13	57	3	0.30
▲ E2761070	▲ EQ761070	7.0	10	16	66	3	0.30
▲ E2761080	▲ EQ761080	8.0	10	19	69	3	0.30
▲ E2761090	-	9.0	10	19	69	3	0.30
▲ E2761100	▲ EQ761100	10.0	10	22	72	4	0.30
▲ E2761120	▲ EQ761120	12.0	12	26	83	4	0.34
▲ E2761140	-	14.0	12	26	83	4	0.34
▲ E2761160	▲ EQ761160	16.0	16	32	92	4	0.34
▲ E2761180	▲ EQ761180	18.0	16	32	92	4	0.44
▲ E2761200	▲ EQ761200	20.0	20	38	104	4	0.44
▲ E2761220	▲ EQ761220	22.0	20	38	104	5	0.44
▲ E2761250	-	25.0	25	45	121	5	0.44

- ▲ : Only available till stock runs out
- ▶ Other shank design on your request.
- ▶ TiN and TiCN Coatings are available on your request.

Tolerances according to DIN 7160 & 7161

	Tolerance range in μm					
	Nominal-Diameter in mm					
	from 1 to 3	over 3 to 6	over 6 to 10	over 10 to 18	over 18 to 30	over 30 to 50
js12	±50	±60	±75	±90	±105	±125
h6	0 -6	0 -8	0 -9	0 -11	0 -13	0 -16

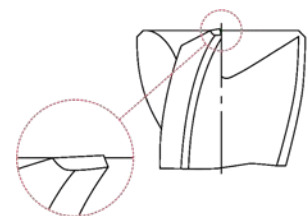

Enforced Cutting Edge

◎ : Excellent ○ : Good

ISO	P											M			K							
	Non-alloy steel					Low alloy steel						High alloyed steel, and tool steel			Stainless steel			Grey cast iron		Nodular cast iron		Malleable cast iron
Material Description	1	2	3	4	5	6	7	8	9	10	11	12	13	14	15	16	17	18	19	20		
VDI 3323	1	2	3	4	5	6	7	8	9	10	11	12	13	14	15	16	17	18	19	20		
HRc	13	25	28	32	30	29	32	38	35	35	20	23	10	10	26	3	25	25	21			
HB	125	190	250	270	300	180	275	300	350	200	240	180	180	260	160	250	130	230				
Recommend	◎	◎	◎	◎	◎	◎	◎	◎	◎	◎	◎	◎	◎	◎	◎	◎	◎	◎	◎			

ISO	N					S					H										
	Aluminum-wrought alloy		Aluminum-cast, alloyed			Copper and Copper Alloys (Bronze / Brass)		Non Metallic Materials			Heat Resistant Super Alloys					Titanium Alloys		Hardened steel	Chilled Cast Iron	Hardened Cast Iron	
Material Description	21	22	23	24	25	26	27	28	29	30	31	32	33	34	35	36	37	38	39	40	41
VDI 3323	21	22	23	24	25	26	27	28	29	30	31	32	33	34	35	36	37	38	39	40	41
HRc	60	100	75	90	130	110	90	100			15	30	25	38	34	55	60	42	55		
HB	60	100	75	90	130	110	90	100			200	280	250	350	320	400 Rm	1050 Rm	550	630	400	550
Recommend	◎	◎	◎	◎	◎	◎	◎	◎	◎	◎	◎	◎	◎	◎	◎	◎	◎	◎	◎	◎	◎



FLAT SHANK

E2606 SERIES

FLAT SHANK

EQ606 SERIES

HSSCo8, 3&4 FLUTE SHORT LENGTH ROUGHING BALL NOSE - FINE

- HSSCo8, 3&4 SCHNEIDEN KURZ SCHRUPPFÄSER STIRNRADIUS - FEIN
- Fraise HSSCo8, 3&4 dents, ébauche, hémisphérique, pas fin, courte
- 3&4 TAGLIENTI, SEMISFERICA, PER SGROSSATURA, SERIE CORTA, B. F. - HSSCo8



HSS Co8
DIN 1889
HR
3&4
30°
R ±0.02
DIN 1835B
P.768~769

Unit : mm

EDP No.	Radius of Ball Nose	Mill Diameter	Shank Diameter	Length of Cut	Overall Length	No. of Flute
▲ E2606060	▲ EQ606060	R3.0	6.0	6	13	3
▲ E2606080	▲ EQ606080	R4.0	8.0	10	19	3
▲ E2606100	-	R5.0	10.0	10	22	3
▲ E2606120	-	R6.0	12.0	12	26	4
▲ E2606160	▲ EQ606160	R8.0	16.0	16	32	4
▲ E2606200	-	R10.0	20.0	20	38	4
▲ E2606250	▲ EQ606250	R12.5	25.0	25	45	4
▲ E2606320	▲ EQ606320	R16.0	32.0	32	53	4

- ▲ : Only available till stock runs out
- ▶ Other shank design on your request.
- ▶ TiN and TiCN Coatings are available on your request.

Tolerances according to DIN 7160 & 7161

	Tolerance range in μm					
	Nominal-Diameter in mm					
	from 1 to 3	over 3 to 6	over 6 to 10	over 10 to 18	over 18 to 30	over 30 to 50
js12	±50	±60	±75	±90	±105	±125
h6	0 -6	0 -8	0 -9	0 -11	0 -13	0 -16

◎ : Excellent ○ : Good

ISO	P											M			K						
	Non-alloy steel					Low alloy steel				High alloyed steel, and tool steel		Stainless steel			Grey cast iron		Nodular cast iron		Malleable cast iron		
Material Description	1	2	3	4	5	6	7	8	9	10	11	12	13	14	15	16	17	18	19	20	
VDI 3323	1	2	3	4	5	6	7	8	9	10	11	12	13	14	15	16	17	18	19	20	
HRc	13	13	25	28	32	10	29	32	38	15	35	15	23	10	10	26	3	25		21	
HB	125	190	250	270	300	180	275	300	350	200	325	200	240	180	180	260	160	250	130	230	
Recommend	◎	◎	◎	◎	◎	◎	◎	◎	◎	○	◎	◎	◎	◎	◎	◎	◎	◎	◎	◎	
ISO	N									S							H				
	Aluminum-wrought alloy		Aluminum-cast, alloyed			Copper and Copper Alloys (Bronze / Brass)		Non Metallic Materials		Heat Resistant Super Alloys					Titanium Alloys		Hardened steel	Chilled Cast Iron	Hardened Cast Iron		
Material Description	21	22	23	24	25	26	27	28	29	30	31	32	33	34	35	36	37	38	39	40	41
VDI 3323	21	22	23	24	25	26	27	28	29	30	31	32	33	34	35	36	37	38	39	40	41
HRc	60	100	75	90	130	110	90	100			15	30	25	38	34			55	60	42	55
HB	60	100	75	90	130	110	90	100			200	280	250	350	320	400 Rm	1050 Rm	550	630	400	550
Recommend	○	○	○	○	○																

HSSCo8, 3&4 FLUTE STUB LENGTH ROUGHING - FINE

- HSSCo8, 3&4 SCHNEIDEN EXTRA KURZ SCHRUPPFRÄSER - FEIN
- Fraise HSSCo8, 3&4 dents, ébauche, pas fin, extra-courte
- 3&4 TAGLIENTI, PER SGROSSATURA, EXTRA CORTA, BOMBATO FINE - HSSCo8



HSS Co8
DIN 327
HR
3&4
30°
DIN 1835B
C x 45°
P.770-771

Unit : mm

EDP No.		Mill Diameter	Shank Diameter	Length of Cut	Overall Length	No. of Flute	Chamfer
UNCOATED	TiAIN	k12	h6				
▲ E2524060	▲ EQ524060	6.0	6	8	52	3	0.18
▲ E2524080	-	8.0	10	11	61	4	0.18
▲ E2524100	-	10.0	10	13	63	4	0.18
▲ E2524120	▲ EQ524120	12.0	12	16	73	4	0.18
▲ E2524140	-	14.0	12	16	73	4	0.25
▲ E2524160	-	16.0	16	19	79	4	0.25
▲ E2524180	▲ EQ524180	18.0	16	19	79	4	0.25
▲ E2524200	-	20.0	20	22	88	4	0.25

- ▲ : Only available till stock runs out
- ▶ Other shank design on your request.
- ▶ TiN and TiCN Coatings are available on your request.

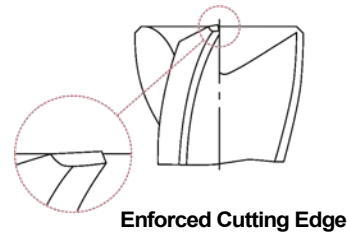

Tolerances according to DIN 7160 & 7161

Tolerance range in μm						
Nominal-Diameter in mm						
	from 1 to 3	over 3 to 6	over 6 to 10	over 10 to 18	over 18 to 30	over 30 to 50
k12	+ 100 0	+ 120 0	+ 150 0	+ 180 0	+ 210 0	+ 250 0
h6	0 - 6	0 - 8	0 - 9	0 - 11	0 - 13	0 - 16

◎ : Excellent ○ : Good

ISO Material Description	P										M			K							
	Non-alloy steel					Low alloy steel					High alloyed steel, and tool steel			Stainless steel			Grey cast iron		Nodular cast iron		Malleable cast iron
VDI 3323	1	2	3	4	5	6	7	8	9	10	11	12	13	14	15	16	17	18	19	20	
HRc	13	25	28	32	10	29	32	38	15	35	15	23	10	10	26	3	25	42	55		
HB	125	190	250	270	300	180	275	300	350	200	325	200	240	180	180	260	160	250	130	230	
Recommend	◎	◎	◎	◎	◎	◎	◎	◎	○	◎	◎	◎	◎	◎	◎	◎	◎	◎	◎	◎	
ISO Material Description	N					S					H										
	Aluminum-wrought alloy		Aluminum-cast, alloyed			Copper and Copper Alloys (Bronze / Brass)			Non Metallic Materials		Heat Resistant Super Alloys					Titanium Alloys		Hardened steel	Chilled Cast Iron	Hardened Cast Iron	
VDI 3323	21	22	23	24	25	26	27	28	29	30	31	32	33	34	35	36	37	38	39	40	41
HRc	60	100	75	90	130	110	90	100			15	30	25	38	34	55	60	42	55		
HB	60	100	75	90	130	110	90	100			200	280	250	350	320	400 Rm	1050 Rm	550	630	400	550
Recommend	○	○	○	○	○						◎	◎	◎	◎	◎	◎	◎	◎	◎	◎	◎

CBN END MILLS

i-Xmill END MILLS

i-SMART MODULAR END MILLS

X5070 END MILLS

4G MILL END MILLS

X-POWER PRO END MILLS

TitaNox-POWER END MILLS

JET-POWER END MILLS

V7 PLUS END MILLS

ALU-POWER HPC END MILLS

ALU-POWER END MILLS

D-POWER GRAPHITE END MILLS

D-POWER CFRP END MILLS

ROUTERS

CRX S END MILLS

K-2 END MILLS

ONLY ONE COATED PM60 END MILLS

TANK-POWER END MILLS

GENERAL HSS END MILLS

MILLING CUTTERS

TECHNICAL DATA



FLAT SHANK

E2753 SERIES

FLAT SHANK

EQ753 SERIES

HSSCo8, MULTI FLUTE SHORT LENGTH ROUGHING - FINE

● HSSCo8, MULTI SCHNEIDEN KURZ SCHRUPPFRÄSER - FEIN

● Fraise HSSCo8, multi-dents ébauche, pas fin, courte

● MULTI TAGLIENTE, PER SGROSSATURA, SERIE CORTA, BOMBATO FINE - HSSCo8

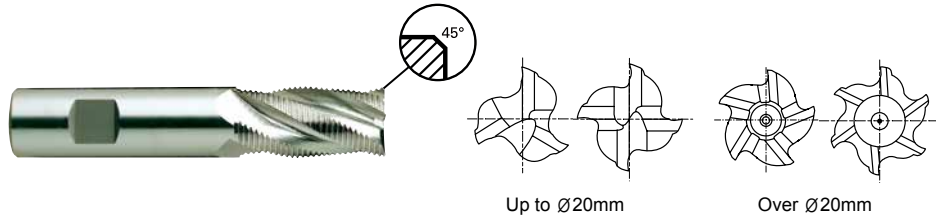

Unit : mm

EDP No.	Mill Diameter	Shank Diameter	Length of Cut	Overall Length	No. of Flute	Chamfer	
							UNCOATED
E2753060	EQ753060	6.0	6	13	57	3	0.18
E2753070	EQ753070	7.0	10	16	66	3	0.18
E2753080	EQ753080	8.0	10	19	69	3	0.18
E2753090	EQ753090	9.0	10	19	69	3	0.18
E2753100	EQ753100	10.0	10	22	72	4	0.18
E2753110	EQ753110	11.0	12	22	79	4	0.18
E2753120	EQ753120	12.0	12	26	83	4	0.18
E2753130	EQ753130	13.0	12	26	83	4	0.18
E2753140	EQ753140	14.0	12	26	83	4	0.25
E2753150	EQ753150	15.0	12	26	83	4	0.25
E2753160	EQ753160	16.0	16	32	92	4	0.25
E2753180	EQ753180	18.0	16	32	92	4	0.25
E2753200	EQ753200	20.0	20	38	104	4	0.25
E2753250	EQ753250	25.0	25	45	121	5	0.36
E2753280	EQ753280	28.0	25	45	121	6	0.36
E2753300	EQ753300	30.0	25	45	121	6	0.36
E2753320	EQ753320	32.0	32	53	133	6	0.51
E2753350	EQ753350	35.0	32	53	133	6	0.51
E2753400	EQ753400	40.0	32	63	155	6	0.56

- ▶ Other shank design on your request.
- ▶ TiN and TiCN Coatings are available on your request.

Tolerances according to DIN 7160 & 7161

	Tolerance range in μm					
	Nominal-Diameter in mm					
	from 1 to 3	over 3 to 6	over 6 to 10	over 10 to 18	over 18 to 30	over 30 to 50
js12	±50	±60	±75	±90	±105	±125
h6	0 -6	0 -8	0 -9	0 -11	0 -13	0 -16

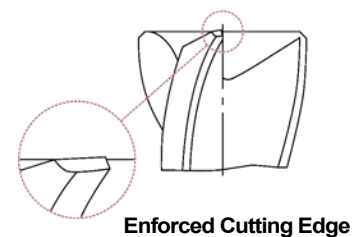

Enforced Cutting Edge

◎ : Excellent ○ : Good

ISO Material Description	P											M			K						
	Non-alloy steel					Low alloy steel				High alloyed steel, and tool steel		Stainless steel			Grey cast iron		Nodular cast iron		Malleable cast iron		
VDI 3323	1	2	3	4	5	6	7	8	9	10	11	12	13	14	15	16	17	18	19	20	
HRc		13	25	28	32	10	29	32	38	15	35	15	23	10	10	26	3	25		21	
HB	125	190	250	270	300	180	275	300	350	200	325	200	240	180	180	260	160	250	130	230	
Recommend	◎	◎	◎	◎	◎	◎	◎	◎	◎	◎	◎	◎	◎	◎	◎	◎	◎	◎	◎	◎	
ISO Material Description	N										S						H				
	Aluminum-wrought alloy		Aluminum-cast, alloyed			Copper and Copper Alloys (Bronze / Brass)			Non Metallic Materials		Heat Resistant Super Alloys						Titanium Alloys		Hardened steel	Chilled Cast Iron	Hardened Cast Iron
VDI 3323	21	22	23	24	25	26	27	28	29	30	31	32	33	34	35	36	37	38	39	40	41
HRc											15	30	25	38	34	34	34	55	60	42	55
HB	60	100	75	90	130	110	90	100			200	280	250	350	320	400 Rm	1050 Rm	550	630	400	550
Recommend	◎	◎	◎	◎	◎																

HSSCo8, MULTI FLUTE LONG LENGTH ROUGHING - FINE

- HSSCo8, MULTI SCHNEIDEN LANG SCHRUPPFRÄSER - FEIN
- Fraise HSSCo8, multi-dents ébauche, pas fin, longue
- MULTI TAGLIENTE, PER SGROSSATURA, SERIE LUNGA, BOMBATO FINE - HSSCo8

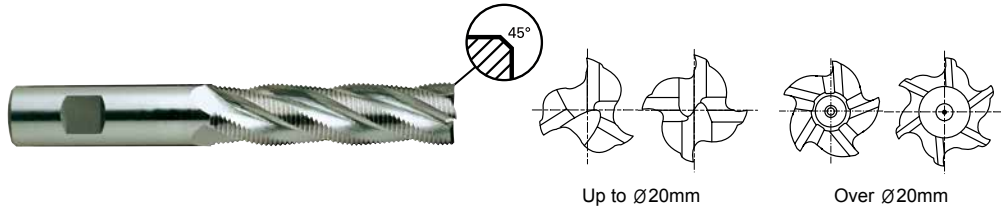

HSS Co8
DIN 844
HR
3-6
30°
DIN 1835B
~Ø20
Ø22~
C x 45°
P.764~767

Unit : mm

EDP No.		Mill Diameter	Shank Diameter	Length of Cut	Overall Length	No. of Flute	Chamfer
UNCOATED	TiAIN	js12	h6				
E2762060	EQ762060	6.0	6	24	68	3	0.18
E2762070	EQ762070	7.0	10	30	80	3	0.18
E2762080	EQ762080	8.0	10	38	88	3	0.18
E2762090	EQ762090	9.0	10	38	88	3	0.18
E2762100	EQ762100	10.0	10	45	95	4	0.18
E2762110	EQ762110	11.0	12	45	102	4	0.18
E2762120	EQ762120	12.0	12	53	110	4	0.18
E2762130	EQ762130	13.0	12	53	110	4	0.18
E2762140	EQ762140	14.0	12	53	110	4	0.25
E2762150	EQ762150	15.0	12	53	110	4	0.25
E2762160	EQ762160	16.0	16	63	123	4	0.25
E2762170	EQ762170	17.0	16	63	123	4	0.25
E2762180	EQ762180	18.0	16	63	123	4	0.25
E2762190	EQ762190	19.0	16	63	123	4	0.25
E2762200	EQ762200	20.0	20	75	141	4	0.25
E2762220	EQ762220	22.0	20	75	141	5	0.36
E2762240	EQ762240	24.0	25	90	166	5	0.36
E2762250	EQ762250	25.0	25	90	166	5	0.36
E2762260	EQ762260	26.0	25	90	166	6	0.36
E2762280	EQ762280	28.0	25	90	166	6	0.36
E2762300	EQ762300	30.0	25	90	166	6	0.36
E2762320	EQ762320	32.0	32	106	186	6	0.51
E2762350	EQ762350	35.0	32	106	186	6	0.51
E2762360	EQ762360	36.0	32	106	186	6	0.56
E2762380	EQ762380	38.0	32	125	217	6	0.56
E2762400	EQ762400	40.0	32	125	217	6	0.56
E2762940	EQ762940	40.0	40	125	217	6	0.56

- ▶ Other shank design on your request.
- ▶ TiN and TiCN Coatings are available on your request.

Tolerances according to DIN 7160 & 7161

	Tolerance range in μm					
	Nominal-Diameter in mm					
	from 1 to 3	over 3 to 6	over 6 to 10	over 10 to 18	over 18 to 30	over 30 to 50
js12	±50	±60	±75	±90	±105	±125
h6	0 -6	0 -8	0 -9	0 -11	0 -13	0 -16

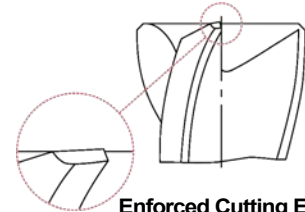

Enforced Cutting Edge

◎ : Excellent ○ : Good

ISO Material Description	P										M			K							
	Non-alloy steel					Low alloy steel					High alloyed steel, and tool steel			Stainless steel			Grey cast iron		Nodular cast iron		Malleable cast iron
VDI 3323	1	2	3	4	5	6	7	8	9	10	11	12	13	14	15	16	17	18	19	20	
HRC																					
HB	125	190	250	270	300	180	275	300	350	200	325	200	240	180	180	260	160	250	130	230	
Recommend	◎	◎	◎	◎	◎	◎	◎	◎	◎	◎	◎	◎	◎	◎	◎	◎	◎	◎	◎	◎	
ISO Material Description	N				S					H											
	Aluminum-wrought alloy		Aluminum-cast, alloyed		Copper and Copper Alloys (Bronze / Brass)			Non Metallic Materials		Heat Resistant Super Alloys			Titanium Alloys		Hardened steel	Chilled Cast Iron	Hardened Cast Iron				
VDI 3323	21	22	23	24	25	26	27	28	29	30	31	32	33	34	35	36	37	38	39	40	41
HRC																					
HB	60	100	75	90	130	110	90	100			15	30	25	38	34	400 Rm	1050 Rm	550	630	400	550
Recommend	◎	◎	◎	◎	◎	◎	◎	◎	◎	◎	◎	◎	◎	◎	◎	◎	◎	◎	◎	◎	◎



FLAT SHANK

E2757 SERIES

FLAT SHANK

EQ757 SERIES

HSSCo8, 3&4 FLUTE SHORT LENGTH ROUGHING BALL NOSE - COARSE

- HSSCo8, 3&4 SCHNEIDEN KURZ SCHRUPPFÄSER STIRNRADIUS - GROB
- Fraise HSSCo8, 3&4 dents, ébauche, hémisphérique, pas grossier, courte
- 3&4 TAGLIENTI, SEMISFERICA, PER SGROSSATURA, SERIE CORTA, B. F. - HSSCo8



HSS Co8
DIN 1889
NR
3&4
30°
R ±0.02
DIN 1835B
P.768-769

Unit : mm

EDP No.	Radius of Ball Nose	Mill Diameter	Shank Diameter	Length of Cut	Overall Length	No. of Flute	
							UNCOATED
▲ E2757080	▲ EQ757080	R4.0	8.0	10	19	69	3
▲ E2757100	-	R5.0	10.0	10	22	72	3
▲ E2757120	-	R6.0	12.0	12	26	83	4
▲ E2757160	▲ EQ757160	R8.0	16.0	16	32	92	4
▲ E2757200	-	R10.0	20.0	20	38	104	4
	▲ EQ757250	R12.5	25.0	25	45	121	4

- ▲ : Only available till stock runs out
- ▶ Other shank design on your request.
- ▶ TiN and TiCN Coatings are available on your request.

Tolerances according to DIN 7160 & 7161

Tolerance range in μm						
Nominal-Diameter in mm						
	from 1 to 3	over 3 to 6	over 6 to 10	over 10 to 18	over 18 to 30	over 30 to 50
js12	±50	±60	±75	±90	±105	±125
h6	0 - 6	0 - 8	0 - 9	0 - 11	0 - 13	0 - 16

◎ : Excellent ○ : Good

ISO Material Description	P											M			K						
	Non-alloy steel					Low alloy steel				High alloyed steel, and tool steel		Stainless steel			Grey cast iron		Nodular cast iron	Malleable cast iron			
VDI 3323	1	2	3	4	5	6	7	8	9	10	11	12	13	14	15	16	17	18	19	20	
HRc		13	25	28	32	10	29	32	38	15	35	15	23	10	10	26	3	25		21	
HB	125	190	250	270	300	180	275	300	350	200	325	200	240	180	180	260	160	250	130	230	
Recommend	◎	◎	◎	◎	◎	◎	◎	◎	◎	○	◎	◎	◎	◎	◎	◎	◎	◎	◎	◎	
ISO Material Description	N										S						H				
	Aluminum-wrought alloy		Aluminum-cast, alloyed			Copper and Copper Alloys (Bronze / Brass)			Non Metallic Materials		Heat Resistant Super Alloys						Titanium Alloys		Hardened steel	Chilled Cast Iron	Hardened Cast Iron
VDI 3323	21	22	23	24	25	26	27	28	29	30	31	32	33	34	35	36	37	38	39	40	41
HRc											15	30	25	38	34			55	60	42	55
HB	60	100	75	90	130	110	90	100			200	280	250	350	320	400 Rm	1050 Rm	550	630	400	550
Recommend	○	○	○	○	○																

HSSCo8, 3 FLUTE SHORT LENGTH ROUGHING - COARSE

- HSSCo8, 3 SCHNEIDEN KURZ SCHRUPPFRÄSER - GROB
- Ⓛ Fraise HSSCo8, 3 dents, ébauche, pas grossier, courte
- Ⓜ 3 TAGLIANTI, PER SGROSSATURA, SERIE CORTA, BOMBATO GROSSO - HSSCo8



HSS Co8
DIN 844
NR
3
30°
DIN 1835B
C x 45°
P.764~767

Unit : mm

EDP No.		Mill Diameter	Shank Diameter	Length of Cut	Overall Length	Chamfer
UNCOATED	TiAIN	js12	h6			
▲ E2764100	▲ EQ764100	10.0	10	22	72	0.34
▲ E2764120	▲ EQ764120	12.0	12	26	83	0.50
▲ E2764140	▲ EQ764140	14.0	12	26	83	0.55
▲ E2764160	▲ EQ764160	16.0	16	32	92	0.55
▲ E2764180	▲ EQ764180	18.0	16	32	92	0.55
▲ E2764200	▲ EQ764200	20.0	20	38	104	0.55
▲ E2764220	-	22.0	20	38	104	0.55
▲ E2764250	▲ EQ764250	25.0	25	45	121	0.55
-	▲ EQ764300	30.0	25	45	121	0.70
▲ E2764320	▲ EQ764320	32.0	32	53	133	0.70
▲ E2764360	▲ EQ764360	36.0	32	53	133	0.70
▲ E2764400	▲ EQ764400	40.0	32	63	155	0.88

- ▲ : Only available till stock runs out
- ▶ Other shank design on your request.
- ▶ TiN and TiCN Coatings are available on your request.

Tolerances according to DIN 7160 & 7161

Tolerance range in μm						
Nominal-Diameter in mm						
	from 1 to 3	over 3 to 6	over 6 to 10	over 10 to 18	over 18 to 30	over 30 to 50
js12	±50	±60	±75	±90	±105	±125
h6	0 -6	0 -8	0 -9	0 -11	0 -13	0 -16

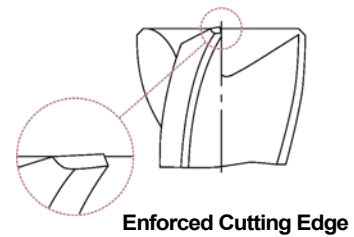

◎ : Excellent ○ : Good

ISO Material Description	P										M			K							
	Non-alloy steel					Low alloy steel					High alloyed steel, and tool steel			Stainless steel			Grey cast iron		Nodular cast iron		Malleable cast iron
VDI 3323	1	2	3	4	5	6	7	8	9	10	11	12	13	14	15	16	17	18	19	20	
HRc	13	25	28	32	10	29	32	38	15	35	15	23	10	10	26	3	25	42	55		
HB	125	190	250	270	300	180	275	300	350	200	240	180	180	260	160	250	130	230			
Recommend	◎	◎	◎	◎	◎	◎	◎	◎	○	◎	◎	○	◎	◎	◎	◎	◎	◎	◎	◎	
ISO Material Description	N										S						H				
	Aluminum-wrought alloy		Aluminum-cast, alloyed			Copper and Copper Alloys (Bronze / Brass)			Non Metallic Materials		Heat Resistant Super Alloys						Titanium Alloys		Hardened steel	Chilled Cast Iron	Hardened Cast Iron
VDI 3323	21	22	23	24	25	26	27	28	29	30	31	32	33	34	35	36	37	38	39	40	41
HRc											15	30	25	38	34			55	60	42	55
HB	60	100	75	90	130	110	90	100			200	280	250	350	320	400 Rm	1050 Rm	550	630	400	550
Recommend	○	○	○	○	○																



FLAT SHANK **E2765** SERIES
 FLAT SHANK **EQ765** SERIES

HSSCo8, 3 FLUTE LONG LENGTH ROUGHING - COARSE

● **HSSCo8, 3 SCHNEIDEN LANG SCHRUPPFRÄSER - GROB**
 ● **Fraise HSSCo8, 3 dents, ébauche, pas grossier, longue**
 ● **3 TAGLIENTI, PER SGROSSATURA, SERIE LUNGA, BOMBATO GROSSO - HSSCo8**



HSS Co8
DIN 844
NR
3
30°
DIN 1835B
C x 45°
P.764~767

Unit : mm

	EDP No.		Mill Diameter	Shank Diameter	Length of Cut	Overall Length	Chamfer
	UNCOATED	TiAIN	js12	h6			
▲	E2765100	▲ EQ765100	10.0	10	45	95	0.34
▲	E2765120	▲ EQ765120	12.0	12	53	110	0.50
▲	E2765140	-	14.0	12	53	110	0.55
▲	E2765160	▲ EQ765160	16.0	16	63	123	0.55
▲	E2765180	▲ EQ765180	18.0	16	63	123	0.55
▲	E2765200	▲ EQ765200	20.0	20	75	141	0.55
	-	▲ EQ765250	25.0	25	90	166	0.55
▲	E2765280	-	28.0	25	90	166	0.70
▲	E2765300	▲ EQ765300	30.0	25	90	166	0.70
	-	▲ EQ765360	36.0	32	106	186	0.70
▲	E2765400	-	40.0	32	125	217	0.88

- ▲ : Only available till stock runs out
- ▶ Other shank design on your request.
- ▶ TiN and TiCN Coatings are available on your request.

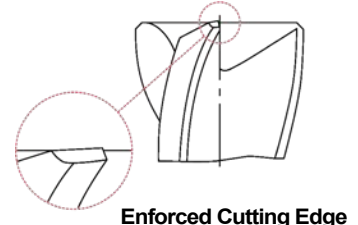

Tolerances according to DIN 7160 & 7161

	Tolerance range in μm					
	Nominal-Diameter in mm					
	from 1 to 3	over 3 to 6	over 6 to 10	over 10 to 18	over 18 to 30	over 30 to 50
js12	± 50	± 60	± 75	± 90	± 105	± 125
h6	0 -6	0 -8	0 -9	0 -11	0 -13	0 -16

◎ : Excellent ○ : Good

ISO	P											M			K					
	Non-alloy steel					Low alloy steel				High alloyed steel, and tool steel		Stainless steel			Grey cast iron		Nodular cast iron		Malleable cast iron	
Material Description	1	2	3	4	5	6	7	8	9	10	11	12	13	14	15	16	17	18	19	20
VDI 3323																				
HRc	13	25	28	32	10	29	32	38	15	35	15	23	10	10	26	3	25			
HB	125	190	250	270	300	180	275	300	350	200	325	200	240	180	180	260	160	250	130	230
Recommend	◎	◎	◎	◎	◎	◎	◎	◎	○	◎	○									

ISO	N										S							H			
	Aluminum-wrought alloy		Aluminum-cast, alloyed			Copper and Copper Alloys (Bronze / Brass)			Non Metallic Materials		Heat Resistant Super Alloys					Titanium Alloys		Hardened steel	Chilled Cast Iron	Hardened Cast Iron	
Material Description	21	22	23	24	25	26	27	28	29	30	31	32	33	34	35	36	37	38	39	40	41
VDI 3323																					
HRc	21	22	23	24	25	26	27	28	29	30	31	32	33	34	35	36	37	38	39	40	41
HB	60	100	75	90	130	110	90	100			200	280	250	350	320	400 Rm	1050 Rm	550	630	400	550
Recommend	○	○	○	○	○																

HSSCo8, 3 FLUTE 37° HELIX SHORT LENGTH ROUGHING for ALUMINIUM

● HSSCo8, 3 SCHNEIDEN 37° RECHTSSPIRALE KURZ SCHRUPPFÄRER für ALUMINIUM
 ○ Fraise HSSCo8, 3 dents, ébauche pour aluminium, hélice 37°, courte
 ○ 3 TAGLIANTI, ELICA 37°, PER SGROSSATURA, SERIE CORTA - HSSCo8

for ALUMINIUM
für ALUMINIUM



HSS Co8
DIN 844
WR
3
37°
DIN 1835B
C x 45°
P.776-777

Unit : mm

EDP No.	Mill Diameter	Shank Diameter	Length of Cut	Overall Length	Chamfer
UNCOATED	js12	h6			
E2755060	6.0	6	13	57	0.51
E2755080	8.0	10	19	69	0.51
E2755100	10.0	10	22	72	0.60
E2755120	12.0	12	26	83	0.74
E2755140	14.0	12	26	83	0.94
E2755160	16.0	16	32	92	0.94
E2755180	18.0	16	32	92	0.94
E2755200	20.0	20	38	104	0.94
E2755220	22.0	20	38	104	0.94
E2755250	25.0	25	45	121	0.94
E2755300	30.0	25	45	121	1.23

- ▶ Other shank design on your request.
- ▶ TiN and TiCN Coatings are available on your request.

Tolerances according to DIN 7160 & 7161

	Tolerance range in μm					
	Nominal-Diameter in mm					
	from 1 to 3	over 3 to 6	over 6 to 10	over 10 to 18	over 18 to 30	over 30 to 50
js12	±50	±60	±75	±90	±105	±125
h6	0 -6	0 -8	0 -9	0 -11	0 -13	0 -16

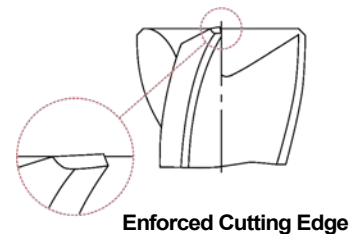

◎ : Excellent ○ : Good

ISO Material Description	P										M			K							
	Non-alloy steel					Low alloy steel					High alloyed steel, and tool steel			Stainless steel			Grey cast iron		Nodular cast iron		Malleable cast iron
VDI 3323	1	2	3	4	5	6	7	8	9	10	11	12	13	14	15	16	17	18	19	20	
HRc	13	25	28	32	10	29	32	38	15	35	15	23	10	10	26	3	25	19	21		
HB	125	190	250	270	300	180	275	300	350	200	325	200	240	180	180	260	160	250	130	230	
Recommend	◎	◎	○	○	○	◎	○	○	○	◎	◎										
ISO Material Description	N									S						H					
	Aluminum-wrought alloy		Aluminum-cast, alloyed			Copper and Copper Alloys (Bronze / Brass)			Non Metallic Materials		Heat Resistant Super Alloys						Titanium Alloys		Hardened steel	Chilled Cast Iron	Hardened Cast Iron
VDI 3323	21	22	23	24	25	26	27	28	29	30	31	32	33	34	35	36	37	38	39	40	41
HRc											15	30	25	38	34			55	60	42	55
HB	60	100	75	90	130	110	90	100			200	280	250	350	320	400 Rm	1050 Rm	550	630	400	550
Recommend	◎	◎	◎	◎	○																

HSSCo8, 3 FLUTE 37° HELIX LONG LENGTH ROUGHING for ALUMINIUM

HSSCo8, 3 SCHNEIDEN 37° RECHTSSPIRALE LANG SCHRUPPFRÄSER für ALUMINIUM
Fraise HSSCo8, 3 dents, ébauche pour aluminium, hélice 37°, longue
3 TAGLIENTI, ELICA 37°, PER SGROSSATURA, SERIE LUNGA, B.G. - HSSCo8

for ALUMINIUM
für ALUMINIUM



P.776~777

Unit : mm

EDP No.	Mill Diameter	Shank Diameter	Length of Cut	Overall Length	Chamfer
UNCOATED	js12	h6			
▲ E2756100	10.0	10	45	95	0.60
▲ E2756120	12.0	12	53	110	0.74
▲ E2756140	14.0	12	53	110	0.76
▲ E2756160	16.0	16	63	123	0.94
▲ E2756180	18.0	16	63	123	0.76
▲ E2756200	20.0	20	75	141	0.94
▲ E2756220	22.0	20	75	141	0.94
▲ E2756250	25.0	25	90	166	0.94
▲ E2756300	30.0	25	90	166	1.23

- ▲ : Only available till stock runs out
- ▶ Other shank design on your request.
- ▶ TiN and TiCN Coatings are available on your request.

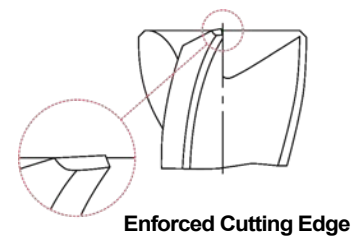

Tolerances according to DIN 7160 & 7161

	Tolerance range in μm					
	Nominal-Diameter in mm					
	from 1 to 3	over 3 to 6	over 6 to 10	over 10 to 18	over 18 to 30	over 30 to 50
js12	±50	±60	±75	±90	±105	±125
h6	0 -6	0 -8	0 -9	0 -11	0 -13	0 -16

ISO Material Description	P										M			K							
	Non-alloy steel					Low alloy steel					High alloyed steel, and tool steel			Stainless steel			Grey cast iron		Nodular cast iron	Malleable cast iron	
VDI 3323	1	2	3	4	5	6	7	8	9	10	11	12	13	14	15	16	17	18	19	20	
HRc	13	25	28	32	10	29	32	38	15	35	15	23	10	10	26	3	25			21	
HB	125	190	250	270	300	180	275	300	350	200	325	200	240	180	180	260	160	250	130	230	
Recommend	◎	◎	○	○	○	◎	○	○	○	◎											
ISO Material Description	N										S						H				
	Aluminum-wrought alloy		Aluminum-cast, alloyed			Copper and Copper Alloys (Bronze / Brass)			Non Metallic Materials		Heat Resistant Super Alloys						Titanium Alloys		Hardened steel	Chilled Cast Iron	Hardened Cast Iron
VDI 3323	21	22	23	24	25	26	27	28	29	30	31	32	33	34	35	36	37	38	39	40	41
HRc											15	30	25	38	34			55	60	42	55
HB	60	100	75	90	130	110	90	100			200	280	250	350	320	400 Rm	1050 Rm	550	630	400	550
Recommend	◎	◎	◎	◎	○																

◎ : Excellent ○ : Good

HSSCo8, MULTI FLUTE SHORT LENGTH ROUGHING - COARSE

- HSSCo8, MULTI SCHNEIDEN KURZ SCHRUPPFRÄSER - GROB
- Fraise HSSCo8, multi-dents ébauche, pas grossier, courte
- MULTI TAGLIENTE, PER SGROSSATURA, SERIE CORTA, BOMBATO GROSSO - HSSCo8

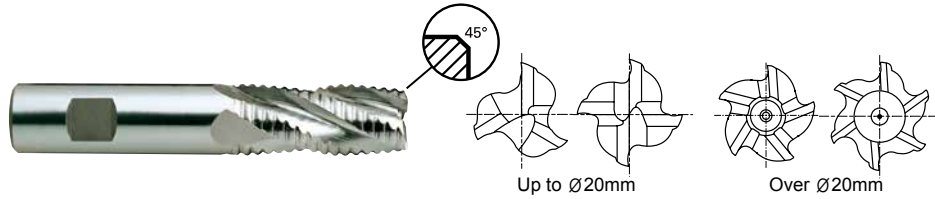

HSS Co8
DIN 844
NR
3-6
30°
DIN 1835B
~Ø20
Ø22~
C x 45°
P.764~767

Unit : mm

EDP No.		Mill Diameter	Shank Diameter	Length of Cut	Overall Length	No. of Flute	Chamfer
UNCOATED	TiAIN	js12	h6				
E2751060	EQ751060	6.0	6	13	57	3	0.25
E2751070	EQ751070	7.0	10	16	66	3	0.25
E2751080	EQ751080	8.0	10	19	69	3	0.25
E2751090	EQ751090	9.0	10	19	69	3	0.34
E2751095	EQ751095	9.5	10	19	69	3	0.34
E2751100	EQ751100	10.0	10	22	72	4	0.34
E2751110	EQ751110	11.0	12	22	79	4	0.50
E2751120	EQ751120	12.0	12	26	83	4	0.50
E2751125	EQ751125	12.5	12	26	83	4	0.50
E2751130	EQ751130	13.0	12	26	83	4	0.50
E2751140	EQ751140	14.0	12	26	83	4	0.55
E2751145	EQ751145	14.5	12	26	83	4	0.55
E2751150	EQ751150	15.0	12	26	83	4	0.55
E2751160	EQ751160	16.0	16	32	92	4	0.55
E2751170	EQ751170	17.0	16	32	92	4	0.55
E2751180	EQ751180	18.0	16	32	92	4	0.55
E2751190	EQ751190	19.0	16	32	92	4	0.55
E2751200	EQ751200	20.0	20	38	104	4	0.55
E2751901	EQ751901	20.0	16	38	98	4	0.55
E2751220	EQ751220	22.0	20	38	104	5	0.55

▶ Other shank design on your request.
 ▶ TiN and TiCN Coatings are available on your request.

▶ NEXT PAGE

Tolerances according to DIN 7160 & 7161

	Tolerance range in μm					
	Nominal-Diameter in mm					
	from 1 to 3	over 3 to 6	over 6 to 10	over 10 to 18	over 18 to 30	over 30 to 50
js12	±50	±60	±75	±90	±105	±125
h6	0 -6	0 -8	0 -9	0 -11	0 -13	0 -16

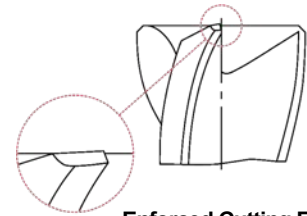

Enforced Cutting Edge

◎ : Excellent ○ : Good

ISO Material Description	P										M			K											
	Non-alloy steel					Low alloy steel					High alloyed steel, and tool steel			Stainless steel			Grey cast iron		Nodular cast iron		Malleable cast iron				
VDI 3323	1	2	3	4	5	6	7	8	9	10	11	12	13	14	15	16	17	18	19	20					
HRC																									
HB	125	190	250	270	300	180	275	300	350	200	325	200	240	180	180	260	160	250	130	230					
Recommend	◎	◎	◎	◎	◎	◎	◎	◎	◎	◎	◎	◎	◎	◎	◎	◎	◎	◎	◎	◎					
ISO Material Description	N					S					H														
	Aluminum-wrought alloy		Aluminum-cast, alloyed			Copper and Copper Alloys (Bronze / Brass)			Non Metallic Materials		Heat Resistant Super Alloys			Titanium Alloys		Hardened steel		Chilled Cast Iron		Hardened Cast Iron					
VDI 3323	21	22	23	24	25	26	27	28	29	30	31	32	33	34	35	36	37	38	39	40	41				
HRC																									
HB	60	100	75	90	130	110	90	100			15	30	25	38	34	200	280	250	350	400 Rm	1050 Rm	550	630	400	550
Recommend	◎	◎	◎	◎	◎	◎	◎	◎	◎	◎	◎	◎	◎	◎	◎	◎	◎	◎	◎	◎	◎	◎	◎	◎	◎



FLAT SHANK

E2751 SERIES

FLAT SHANK

EQ751 SERIES

HSSCo8, MULTI FLUTE SHORT LENGTH ROUGHING - COARSE

- **HSSCo8, MULTI SCHNEIDEN KURZ SCHRUPPFRÄSER - GROB**
- **Fraise HSSCo8, multi-dents ébauche, pas grossier, courte**
- **MULTI TAGLIENTE, PER SGROSSATURA, SERIE CORTA, BOMBATO GROSSO - HSSCo8**

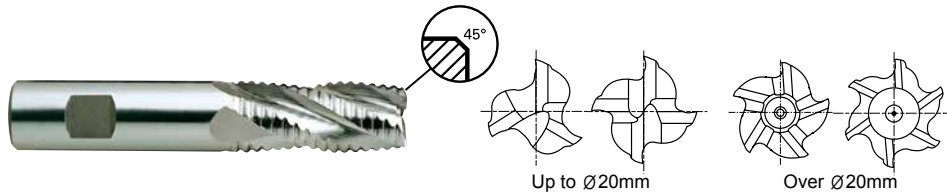

HSS Co8
DIN 844
NR
3-6
30°
DIN 1835B
~Ø20
Ø22~
C x 45°
P.764~767

Unit : mm

EDP No.	Mill Diameter	Shank Diameter	Length of Cut	Overall Length	No. of Flute	Chamfer	
							UNCOATED
E2751240	EQ751240	24.0	25	45	121	5	0.55
E2751250	EQ751250	25.0	25	45	121	5	0.55
E2751260	EQ751260	26.0	25	45	121	6	0.55
E2751280	EQ751280	28.0	25	45	121	6	0.70
E2751300	EQ751300	30.0	25	45	121	6	0.70
E2751320	EQ751320	32.0	32	53	133	6	0.70
E2751340	EQ751340	34.0	32	53	133	6	0.70
E2751350	EQ751350	35.0	32	53	133	6	0.70
E2751360	EQ751360	36.0	32	53	133	6	0.70
E2751380	EQ751380	38.0	32	63	155	6	0.70
E2751938	EQ751938	38.0	40	63	155	6	0.70
E2751400	EQ751400	40.0	32	63	155	6	0.88
E2751940	EQ751940	40.0	40	63	155	6	0.88
E2751450	EQ751450	45.0	32	63	143	6	0.88
E2751500	EQ751500	50.0	50	75	177	6	0.88

- ▶ Other shank design on your request.
- ▶ TiN and TiCN Coatings are available on your request.

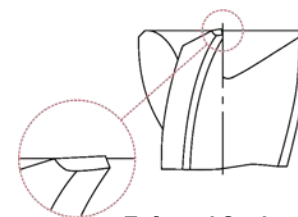

Enforced Cutting Edge

Tolerances according to DIN 7160 & 7161

	Tolerance range in μm					
	Nominal-Diameter in mm					
	from 1 to 3	over 3 to 6	over 6 to 10	over 10 to 18	over 18 to 30	over 30 to 50
js12	±50	±60	±75	±90	±105	±125
h6	0 -6	0 -8	0 -9	0 -11	0 -13	0 -16

◎ : Excellent ○ : Good

ISO Material Description	P										M			K							
	Non-alloy steel					Low alloy steel					High alloyed steel, and tool steel			Stainless steel			Grey cast iron		Nodular cast iron		Malleable cast iron
VDI 3323	1	2	3	4	5	6	7	8	9	10	11	12	13	14	15	16	17	18	19	20	
HRc		13	25	28	32	10	29	32	38	15	35	15	23	10	10	26	3	25			
HB	125	190	250	270	300	180	275	300	350	200	325	200	240	180	180	260	160	250	130	230	
Recommend	◎	◎	◎	◎	◎	◎	◎	◎	◎	◎	◎	◎	◎	◎	◎	◎	◎	◎	◎	◎	
ISO Material Description	N										S							H			
	Aluminum-wrought alloy		Aluminum-cast, alloyed			Copper and Copper Alloys (Bronze / Brass)			Non Metallic Materials		Heat Resistant Super Alloys					Titanium Alloys		Hardened steel	Chilled Cast Iron	Hardened Cast Iron	
VDI 3323	21	22	23	24	25	26	27	28	29	30	31	32	33	34	35	36	37	38	39	40	41
HRc											15	30	25	38	34			55	60	42	55
HB	60	100	75	90	130	110	90	100			200	280	250	350	320	400 Rm	1050 Rm	550	630	400	550
Recommend	◎	◎	◎	◎	◎																

HSSCo8, MULTI FLUTE LONG LENGTH ROUGHING - COARSE

- HSSCo8, MULTI SCHNEIDEN LANG SCHRUPPFRÄSER - GROB
- Fraise HSSCo8, multi-dents ébauche, pas grossier, longue
- MULTI TAGLIENTE, PER SGROSSATURA, SERIE LUNGA, BOMBATO GROSSO - HSSCo8

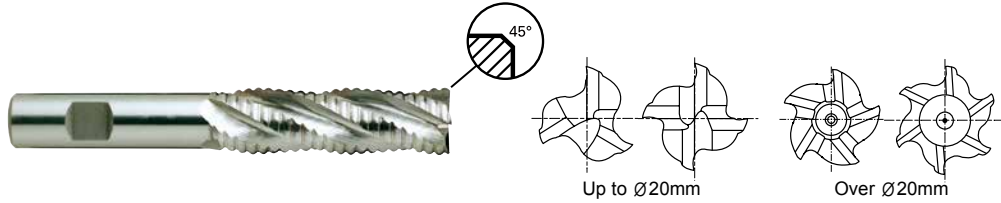

HSS Co8
DIN 844
NR
3-6
30°
DIN 1835B
~Ø20
Ø22~
C x 45°
P.764~767

Unit : mm

EDP No.		Mill Diameter	Shank Diameter	Length of Cut	Overall Length	No. of Flute	Chamfer
UNCOATED	TiAIN	js12	h6				
E2752060	EQ752060	6.0	6	24	68	3	0.25
E2752070	EQ752070	7.0	10	30	80	3	0.25
E2752080	EQ752080	8.0	10	38	88	3	0.25
E2752090	EQ752090	9.0	10	38	88	3	0.34
E2752100	EQ752100	10.0	10	45	95	4	0.34
E2752110	EQ752110	11.0	12	45	102	4	0.50
E2752120	EQ752120	12.0	12	53	110	4	0.50
E2752130	EQ752130	13.0	12	53	110	4	0.50
E2752140	EQ752140	14.0	12	53	110	4	0.55
E2752150	EQ752150	15.0	12	53	110	4	0.55
E2752160	EQ752160	16.0	16	63	123	4	0.55
E2752170	EQ752170	17.0	16	63	123	4	0.55
E2752180	EQ752180	18.0	16	63	123	4	0.55
E2752190	EQ752190	19.0	16	63	123	4	0.55
E2752200	EQ752200	20.0	20	75	141	4	0.55
E2752901	EQ752901	20.0	16	75	135	4	0.55
E2752220	EQ752220	22.0	20	75	141	5	0.55
E2752902	EQ752902	22.0	25	75	151	5	0.55

- ▶ Other shank design on your request.
- ▶ TiN and TiCN Coatings are available on your request.

▶ NEXT PAGE

Tolerances according to DIN 7160 & 7161

Tolerance range in μm						
Nominal-Diameter in mm						
	from 1 to 3	over 3 to 6	over 6 to 10	over 10 to 18	over 18 to 30	over 30 to 50
js12	±50	±60	±75	±90	±105	±125
h6	0 - 6	0 - 8	0 - 9	0 - 11	0 - 13	0 - 16

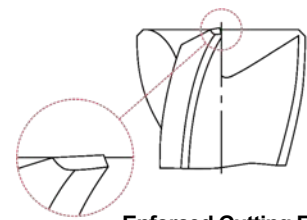

Enforced Cutting Edge

◎ : Excellent ○ : Good

ISO Material Description	P									M			K								
	Non-alloy steel					Low alloy steel				High alloyed steel, and tool steel			Stainless steel			Grey cast iron		Nodular cast iron		Malleable cast iron	
VDI 3323	1	2	3	4	5	6	7	8	9	10	11	12	13	14	15	16	17	18	19	20	
HRC	13	25	28	32	10	29	32	38	15	35	15	23	10	10	26	3	25		21		
HB	125	190	250	270	300	180	275	300	350	200	325	200	240	180	180	260	160	250	130	230	
Recommend	◎	◎	◎	◎	◎	◎	◎	◎	○	◎	○										
ISO Material Description	N				S					H											
	Aluminum-wrought alloy		Aluminum-cast, alloyed		Copper and Copper Alloys (Bronze / Brass)			Non Metallic Materials		Heat Resistant Super Alloys			Titanium Alloys		Hardened steel	Chilled Cast Iron	Hardened Cast Iron				
VDI 3323	21	22	23	24	25	26	27	28	29	30	31	32	33	34	35	36	37	38	39	40	41
HRC											15	30	25	38	34			55	60	42	55
HB	60	100	75	90	130	110	90	100			200	280	250	350	320	400 Rm	1050 Rm	550	630	400	550
Recommend	○	○	○	○	○																



FLAT SHANK **E2752** SERIES
 FLAT SHANK **EQ752** SERIES

HSSCo8, MULTI FLUTE LONG LENGTH ROUGHING - COARSE

● **HSSCo8, MULTI SCHNEIDEN LANG SCHRUPPFRÄSER - GROB**
 ● **Fraise HSSCo8, multi-dents ébauche, pas grossier, longue**
 ● **MULTI TAGLIENTE, PER SGROSSATURA, SERIE LUNGA, BOMBATO GROSSO - HSSCo8**

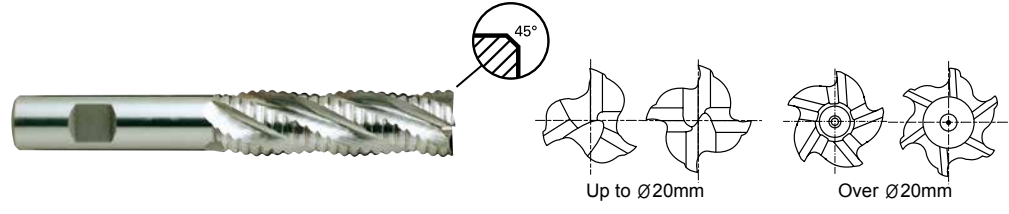

P.764~767

Unit : mm

EDP No.	Mill Diameter	Shank Diameter	Length of Cut	Overall Length	No. of Flute	Chamfer	
							UNCOATED
E2752240	EQ752240	24.0	25	90	166	5	0.55
E2752250	EQ752250	25.0	25	90	166	5	0.55
E2752260	EQ752260	26.0	25	90	166	6	0.55
E2752280	EQ752280	28.0	25	90	166	6	0.70
E2752300	EQ752300	30.0	25	90	166	6	0.70
E2752320	EQ752320	32.0	32	106	186	6	0.70
E2752350	EQ752350	35.0	32	106	186	6	0.70
E2752360	EQ752360	36.0	32	106	186	6	0.70
E2752380	EQ752380	38.0	32	125	217	6	0.70
E2752938	EQ752938	38.0	40	125	217	6	0.70
E2752400	EQ752400	40.0	32	125	217	6	0.88
E2752940	EQ752940	40.0	40	125	217	6	0.88

- ▶ Other shank design on your request.
- ▶ TiN and TiCN Coatings are available on your request.

Tolerances according to DIN 7160 & 7161

Tolerance range in μm						
Nominal-Diameter in mm						
	from 1 to 3	over 3 to 6	over 6 to 10	over 10 to 18	over 18 to 30	over 30 to 50
js12	± 50	± 60	± 75	± 90	± 105	± 125
h6	0 - 6	0 - 8	0 - 9	0 - 11	0 - 13	0 - 16

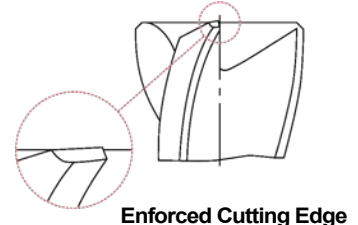

Enforced Cutting Edge

◎ : Excellent ○ : Good

ISO	P											M			K					
	Non-alloy steel					Low alloy steel				High alloyed steel, and tool steel		Stainless steel			Grey cast iron		Nodular cast iron		Malleable cast iron	
Material Description	1	2	3	4	5	6	7	8	9	10	11	12	13	14	15	16	17	18	19	20
VDI 3323																				
HRc	13	25	28	32	10	29	32	38	15	35	15	23	10	10	26	3	25	42	55	
HB	125	190	250	270	300	180	275	300	350	200	325	200	240	180	180	260	160	250	130	230
Recommend	◎	◎	◎	◎	◎	◎	◎	◎	○	◎	○									

ISO	N										S							H			
	Aluminum-wrought alloy		Aluminum-cast, alloyed			Copper and Copper Alloys (Bronze / Brass)			Non Metallic Materials		Heat Resistant Super Alloys					Titanium Alloys		Hardened steel	Chilled Cast Iron	Hardened Cast Iron	
Material Description	21	22	23	24	25	26	27	28	29	30	31	32	33	34	35	36	37	38	39	40	41
VDI 3323																					
HRc	60	100	75	90	130	110	90	100			15	30	25	38	34			55	60	42	55
HB	60	100	75	90	130	110	90	100			200	280	250	350	320	400 Rm	1050 Rm	550	630	400	550
Recommend	○	○	○	○	○																

HSSCo8, MULTI FLUTE SHORT LENGTH ROUGHING - FINE

● HSSCo8, MULTI SCHNEIDEN KURZ SCHRUPPFRÄSER - FEIN

() Fraise HSSCo8, multi-dents ébauche, pas fin, courte

() MULTI TAGLIENTE, SERIE CORTA, PER SGROSSATURA, BOMBATO FINE - HSSCo8

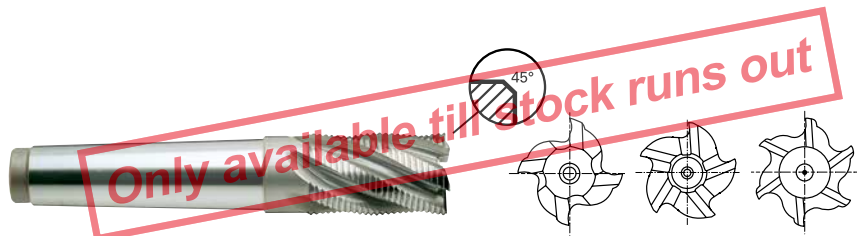

Only available till stock runs out



Unit : mm

EDP No.		Mill Diameter	Length of Cut	Overall Length	Morse Taper No.	No. of Flute	Chamfer
UNCOATED	TiAIN						
▲ E2778200	-	20.0	38	123	2	4	0.25
▲ E2778220	-	22.0	38	123	2	5	0.30
-	▲ EQ778320	32.0	53	178	4	6	0.51
▲ E2778500	-	50.0	75	233	5	6	0.56

▲ : Only available till stock runs out

▶ Other shank design on your request.

▶ TiN and TiCN Coatings are available on your request.

Mill Dia.
Tolerance(mm)
± 0.120

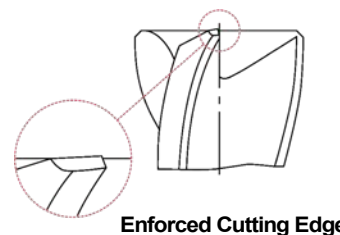
Enforced Cutting Edge

ISO Material Description	P										M						K					
	Non-alloy steel					Low alloy steel					High alloyed steel, and tool steel		Stainless steel				Grey cast iron		Nodular cast iron		Malleable cast iron	
VDI 3323	1	2	3	4	5	6	7	8	9	10	11	12	13	14	15	16	17	18	19	20		
HRc	13	25	28	32	10	29	32	38	10	11	15	23	10	10	26	3	25	21	21			
HB	125	190	250	270	300	180	275	300	350	200	325	200	240	180	180	260	160	250	130	230		
Recommend	◎	◎	◎	◎	◎	◎	◎	◎	○	◎	◎	◎	◎	◎	◎	◎	◎	◎	◎	◎		

ISO Material Description	N					S					H										
	Aluminum-wrought alloy		Aluminum-cast, alloyed			Copper and Copper Alloys (Bronze / Brass)		Non Metallic Materials			Heat Resistant Super Alloys					Titanium Alloys		Hardened steel	Chilled Cast Iron	Hardened Cast Iron	
VDI 3323	21	22	23	24	25	26	27	28	29	30	31	32	33	34	35	36	37	38	39	40	41
HRc	60	100	75	90	130	110	90	100			15	30	25	38	34	55	60	42	55		
HB	60	100	75	90	130	110	90	100			200	280	250	350	320	400 Rm	1050 Rm	550	630	400	550
Recommend	○	○	○	○	○																

◎ : Excellent ○ : Good



MORSE TAPER SHANK

E2777 SERIES

MORSE TAPER SHANK

EQ777 SERIES

HSSCo8, MULTI FLUTE SHORT LENGTH ROUGHING - COARSE

- HSSCo8, MULTI SCHNEIDEN KURZ SCHRUPPFRÄSER - GROB
- Fraise HSSCo8, multi-dents ébauche, pas grossier, courte
- MULTI TAGLIENTE, SERIE CORTA, PER SGROSSATURA, B.G. - HSSCo8

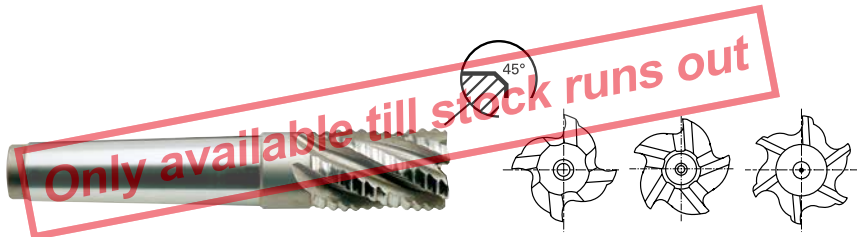

HSS Co8
DIN 845
NR
4-6
30°
DIN 228A
C x 45°
P.764~767

Unit : mm

	EDP No.		Mill Diameter	Length of Cut	Overall Length	Morse Taper No.	No. of Flute	Chamfer
	UNCOATED	TiAIN						
	-	▲ EQ777140	14.0	26	111	2	4	0.56
	▲ E2777160	-	16.0	32	117	2	4	0.56
	▲ E2777180	▲ EQ777180	18.0	32	117	2	4	0.56
	▲ E2777200	-	20.0	38	123	2	4	0.56
	▲ E2777220	-	22.0	38	123	2	5	0.56
	▲ E2777240	-	24.0	45	147	3	5	0.56
	▲ E2777250	-	25.0	45	147	3	5	0.56
	▲ E2777280	-	28.0	45	147	3	6	0.70
	▲ E2777300	-	30.0	45	147	3	6	0.70
	▲ E2777320	▲ EQ777320	32.0	53	178	4	6	0.70
	▲ E2777350	-	35.0	53	178	4	6	0.70
	▲ E2777360	-	36.0	53	178	4	6	0.70
	▲ E2777400	-	40.0	63	188	4	6	0.88
	▲ E2777450	-	45.0	63	188	4	6	0.88

- ▲ : Only available till stock runs out
- ▶ Other shank design on your request.
- ▶ TiN and TiCN Coatings are available on your request.

Mill Dia. Tolerance(mm)
± 0.120

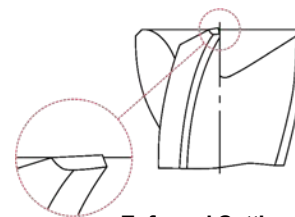

Enforced Cutting Edge

◎ : Excellent ○ : Good

ISO Material Description	P										M			K						
	Non-alloy steel					Low alloy steel					High alloyed steel, and tool steel			Stainless steel			Grey cast iron		Nodular cast iron	
VDI 3323	1	2	3	4	5	6	7	8	9	10	11	12	13	14	15	16	17	18	19	20
HRc	13	25	28	32	10	29	32	38	15	35	15	23	10	10	26	3	25	42	55	
HB	125	190	250	270	300	180	275	300	350	200	325	200	240	180	180	260	160	250	130	230
Recommended	◎	◎	◎	◎	◎	◎	◎	◎	○	◎	○									

ISO Material Description	N										S							H			
	Aluminum-wrought alloy		Aluminum-cast, alloyed			Copper and Copper Alloys (Bronze / Brass)			Non Metallic Materials		Heat Resistant Super Alloys					Titanium Alloys		Hardened steel	Chilled Cast Iron	Hardened Cast Iron	
VDI 3323	21	22	23	24	25	26	27	28	29	30	31	32	33	34	35	36	37	38	39	40	41
HRc	60	100	75	90	130	110	90	100			15	30	25	38	34	55	60	42	55	42	55
HB	60	100	75	90	130	110	90	100			200	280	250	350	320	400 Rm	1050 Rm	550	630	400	550
Recommended	○	○	○	○	○																

HSSCo8, MULTI FLUTE SHORT LENGTH ROUGHING & FINISHING

● HSSCo8, MULTI SCHNEIDEN KURZ SCHRUPPSCHLICHTFRÄSER

○ Fraise HSSCo8, multi-dents ébauche et finition, courte

○ MULTI TAGLIENTE, SERIE CORTA, PER SEMIFINITURA - HSSCo8



P.778~779

Unit : mm

EDP No.		Mill Diameter	Length of Cut	Overall Length	Morse Taper No.	No. of Flute	Chamfer
UNCOATED	TiAIN						
▲ E2779200	▲ EQ779200	20.0	38	123	2	2	4
▲ E2779220	-	22.0	38	123	2	2	5
▲ E2779250	▲ EQ779250	25.0	45	147	3	3	5
▲ E2779260	-	26.0	45	147	3	3	5
▲ E2779280	▲ EQ779280	28.0	45	147	3	3	6
▲ E2779300	▲ EQ779300	30.0	45	147	3	3	6
▲ E2779320	▲ EQ779320	32.0	53	178	4	4	6
-	▲ EQ779350	35.0	53	178	4	4	6
▲ E2779450	-	45.0	63	188	4	4	6

▲ : Only available till stock runs out

▶ Other shank design on your request.

▶ TiN and TiCN Coatings are available on your request.

Mill Dia.
Tolerance(mm)
± 0.120

◎ : Excellent ○ : Good

ISO Material Description	P										M				K								
	Non-alloy steel					Low alloy steel					High alloyed steel, and tool steel				Stainless steel				Grey cast iron		Nodular cast iron		Malleable cast iron
VDI 3323	1	2	3	4	5	6	7	8	9	10	11	12	13	14	15	16	17	18	19	20			
HRC	13	19	25	28	32	10	29	32	38	15	35	15	23	10	10	26	3	25	21	21			
HB	125	190	250	270	300	180	275	300	350	200	325	200	240	180	180	260	160	250	130	230			
Recommend	◎	◎	○	○	○	◎	○	○	○	◎													

ISO Material Description	N									S						H					
	Aluminum-wrought alloy		Aluminum-cast, alloyed			Copper and Copper Alloys (Bronze / Brass)			Non Metallic Materials		Heat Resistant Super Alloys						Titanium Alloys		Hardened steel	Chilled Cast Iron	Hardened Cast Iron
VDI 3323	21	22	23	24	25	26	27	28	29	30	31	32	33	34	35	36	37	38	39	40	41
HRC	60	100	75	90	130	110	90	100			15	30	25	38	34	55	60	42	55	55	55
HB	60	100	75	90	130	110	90	100			200	280	250	350	320	400 Rm	1050 Rm	550	630	400	550
Recommend	◎	◎	◎	◎	○																



FLAT SHANK

E2766 SERIES

FLAT SHANK

EQ766 SERIES

HSSCo8, 3 FLUTE SHORT LENGTH ROUGHING & FINISHING

- HSSCo8, 3 SCHNEIDEN KURZ SCHRUPPSCHLICHTFRÄSER
- Fraise HSSCo8, 3 dents ébauche et finition, courte
- HSSCo8, 3 TAGLIENTI, SERIE CORTA, PER SGROSSATURA & FINITURA



HSS Co8
DIN 844
NF
3
30°
DIN 1835B
P.780~783

Unit : mm

	EDP No.		Mill Diameter	Shank Diameter	Length of Cut	Overall Length
	UNCOATED	TiAIN	k10	h6		
▲ E2766060	▲ EQ766060	6.0	6	13	57	
▲ E2766080	▲ EQ766080	8.0	10	19	69	
▲ E2766100	▲ EQ766100	10.0	10	22	72	
▲ E2766120	▲ EQ766120	12.0	12	26	83	
▲ E2766130	▲ EQ766130	13.0	12	26	83	
▲ E2766140	▲ EQ766140	14.0	12	26	83	
▲ E2766160	▲ EQ766160	16.0	16	32	92	
▲ E2766180	▲ EQ766180	18.0	16	32	92	
▲ E2766200	▲ EQ766200	20.0	20	38	104	
▲ E2766220	▲ EQ766220	22.0	20	38	104	
▲ E2766250	▲ EQ766250	25.0	25	45	121	
▲ E2766280	▲ EQ766280	28.0	25	45	121	
▲ E2766300	-	30.0	25	45	121	
▲ E2766320	-	32.0	32	53	133	
▲ E2766360	▲ EQ766360	36.0	32	53	133	
▲ E2766400	▲ EQ766400	40.0	32	63	155	

- ▲ : Only available till stock runs out
- ▶ Other shank design on your request.
- ▶ TiN and TiCN Coatings are available on your request.

Tolerances according to DIN 7160 & 7161

	Tolerance range in μm					
	Nominal-Diameter in mm					
	from 1 to 3	over 3 to 6	over 6 to 10	over 10 to 18	over 18 to 30	over 30 to 50
k10	+40 0	+48 0	+58 0	+70 0	+84 0	+100 0
h6	0 -6	0 -8	0 -9	0 -11	0 -13	0 -16

◎ : Excellent ○ : Good

ISO	P											M			K						
	Non-alloy steel					Low alloy steel				High alloyed steel, and tool steel		Stainless steel			Grey cast iron		Nodular cast iron	Malleable cast iron			
Material Description	1	2	3	4	5	6	7	8	9	10	11	12	13	14	15	16	17	18	19	20	
VDI 3323																					
HRc																					
HB	125	190	250	270	300	180	275	300	350	200	325	200	240	180	180	260	160	250	130	230	
Recommend	◎	◎	◎	◎	◎	◎	◎	◎	○	◎	○										
ISO	N										S						H				
	Aluminum-wrought alloy		Aluminum-cast, alloyed			Copper and Copper Alloys (Bronze / Brass)			Non Metallic Materials		Heat Resistant Super Alloys						Titanium Alloys		Hardened steel	Chilled Cast Iron	Hardened Cast Iron
Material Description	21	22	23	24	25	26	27	28	29	30	31	32	33	34	35	36	37	38	39	40	41
VDI 3323																					
HRc																					
HB	60	100	75	90	130	110	90	100			200	280	250	350	320	400 Rm	1050 Rm	550	630	400	550
Recommend	○	○	○	○	○																

HSSCo8, 3 FLUTE LONG LENGTH ROUGHING & FINISHING

- HSSCo8, 3 SCHNEIDEN LANG SCHRUPPSCHLICHTFRÄSER
- Fraise HSSCo8, 3 dents, ébauche et finition, longue
- HSSCo8, 3 TAGLIENTI, SERIE CORTA, PER SGROSSATURA & FINITURA



HSS Co8
DIN 844
NF
3
30°
DIN 1835B
P.780~783

Unit : mm

EDP No.		Mill Diameter	Shank Diameter	Length of Cut	Overall Length
UNCOATED	TiAIN	k10	h6		
▲ E2767060	▲ EQ767060	6.0	6	24	68
▲ E2767080	▲ EQ767080	8.0	10	38	88
▲ E2767100	▲ EQ767100	10.0	10	45	95
-	▲ EQ767120	12.0	12	53	110
▲ E2767140	▲ EQ767140	14.0	12	53	110
-	▲ EQ767160	16.0	16	63	123
▲ E2767180	▲ EQ767180	18.0	16	63	123
▲ E2767200	▲ EQ767200	20.0	20	75	141
-	▲ EQ767220	22.0	20	75	141
-	▲ EQ767250	25.0	25	90	166
▲ E2767280	-	28.0	25	90	166
▲ E2767300	▲ EQ767300	30.0	25	90	166
▲ E2767360	▲ EQ767360	36.0	32	106	186
-	▲ EQ767400	40.0	32	125	217

- ▲ : Only available till stock runs out
- ▶ Other shank design on your request.
- ▶ TiN and TiCN Coatings are available on your request.

Tolerances according to DIN 7160 & 7161

	Tolerance range in μm					
	Nominal-Diameter in mm					
	from 1 to 3	over 3 to 6	over 6 to 10	over 10 to 18	over 18 to 30	over 30 to 50
k10	+40 0	+48 0	+58 0	+70 0	+84 0	+100 0
h6	0 -6	0 -8	0 -9	0 -11	0 -13	0 -16

◎ : Excellent ○ : Good

ISO	P											M			K						
	Non-alloy steel					Low alloy steel						High alloyed steel, and tool steel			Stainless steel			Grey cast iron		Nodular cast iron	
Material Description	1	2	3	4	5	6	7	8	9	10	11	12	13	14	15	16	17	18	19	20	
VDI 3323	1	2	3	4	5	6	7	8	9	10	11	12	13	14	15	16	17	18	19	20	
HRC	13	25	28	32	30	10	29	32	38	15	35	15	23	10	10	26	3	25	21	21	
HB	125	190	250	270	300	180	275	300	350	200	325	200	240	180	180	260	160	250	130	230	
Recommend	◎	◎	◎	◎	◎	◎	◎	◎	◎	◎	◎	◎	◎	◎	◎	◎	◎	◎	◎	◎	

ISO	N					S					H										
	Aluminum-wrought alloy		Aluminum-cast, alloyed			Copper and Copper Alloys (Bronze / Brass)			Non Metallic Materials		Heat Resistant Super Alloys			Titanium Alloys		Hardened steel	Chilled Cast Iron	Hardened Cast Iron			
Material Description	21	22	23	24	25	26	27	28	29	30	31	32	33	34	35	36	37	38	39	40	41
VDI 3323	21	22	23	24	25	26	27	28	29	30	31	32	33	34	35	36	37	38	39	40	41
HRC	60	100	75	90	130	110	90	100			15	30	25	38	34	55	60	55	60	42	55
HB	60	100	75	90	130	110	90	100			200	280	250	350	320	400 Rm	1050 Rm	550	630	400	550
Recommend	◎	◎	◎	◎	◎	◎	◎	◎	◎	◎	◎	◎	◎	◎	◎	◎	◎	◎	◎	◎	◎



FLAT SHANK

E2754 SERIES

FLAT SHANK

EQ754 SERIES

HSSCo8, MULTI FLUTE SHORT LENGTH ROUGHING & FINISHING

- HSSCo8, MULTI SCHNEIDEN KURZ SCHRUPPSCHLICHTFRÄSER
- Fraise HSSCo8, multi-dents, ébauche et finition, courte
- MULTI TAGLIENTE, SERIE CORTA PER SEMIFINITURA - HSSCo8



HSS Co8
DIN 844
NF
3-6
30°
DIN 1835B
~Ø20
Ø22~
P.784~787

Unit : mm

EDP No.	Mill Diameter	Shank Diameter	Length of Cut	Overall Length	No. of Flute	
						UNCOATED
▲ E2754060	▲ EQ754060	6.0	6	13	57	3
▲ E2754070	▲ EQ754070	7.0	10	16	66	3
▲ E2754080	▲ EQ754080	8.0	10	19	69	4
▲ E2754090	▲ EQ754090	9.0	10	19	69	4
▲ E2754100	▲ EQ754100	10.0	10	22	72	4
▲ E2754110	▲ EQ754110	11.0	12	22	79	4
▲ E2754120	▲ EQ754120	12.0	12	26	83	4
▲ E2754130	▲ EQ754130	13.0	12	26	83	4
▲ E2754140	-	14.0	12	26	83	4
▲ E2754150	▲ EQ754150	15.0	12	26	83	4
▲ E2754160	▲ EQ754160	16.0	16	32	92	4
▲ E2754180	▲ EQ754180	18.0	16	32	92	4
▲ E2754200	▲ EQ754200	20.0	20	38	104	4
▲ E2754220	▲ EQ754220	22.0	20	38	104	5
▲ E2754250	▲ EQ754250	25.0	25	45	121	5
▲ E2754280	▲ EQ754280	28.0	25	45	121	5
-	▲ EQ754300	30.0	25	45	121	5
▲ E2754320	▲ EQ754320	32.0	32	53	133	5
▲ E2754360	-	36.0	32	53	133	6
▲ E2754400	-	40.0	32	63	155	6

▲ : Only available till stock runs out

- ▶ Other shank design on your request.
- ▶ TiN and TiCN Coatings are available on your request.

Tolerances according to DIN 7160 & 7161

	Tolerance range in μm					
	Nominal-Diameter in mm					
	from 1 to 3	over 3 to 6	over 6 to 10	over 10 to 18	over 18 to 30	over 30 to 50
k10	+40 0	+48 0	+58 0	+70 0	+84 0	+100 0
h6	0 -6	0 -8	0 -9	0 -11	0 -13	0 -16

◎ : Excellent ○ : Good

ISO Material Description	P											M			K					
	Non-alloy steel					Low alloy steel				High alloyed steel, and tool steel		Stainless steel			Grey cast iron		Nodular cast iron		Malleable cast iron	
VDI 3323	1	2	3	4	5	6	7	8	9	10	11	12	13	14	15	16	17	18	19	20
HRc	13	25	28	32	10	29	32	38	15	35	15	23	10	10	26	3	25	42	55	
HB	125	190	250	270	300	180	275	300	350	200	325	200	240	180	180	260	160	250	130	230
Recommend	◎	◎	◎	◎	◎	◎	◎	◎	◎	◎	◎	◎	◎	◎	◎	◎	◎	◎	◎	◎

ISO Material Description	N					S										H					
	Aluminum-wrought alloy		Aluminum-cast, alloyed		Copper and Copper Alloys (Bronze / Brass)	Non Metallic Materials		Heat Resistant Super Alloys					Titanium Alloys			Hardened steel	Chilled Cast Iron	Hardened Cast Iron			
VDI 3323	21	22	23	24	25	26	27	28	29	30	31	32	33	34	35	36	37	38	39	40	41
HRc	21	22	23	24	25	26	27	28	29	30	31	32	33	34	35	36	37	38	39	40	41
HB	60	100	75	90	130	110	90	100			200	280	250	350	320	400 Rm	1050 Rm	550	630	400	550
Recommend	◎	◎	◎	◎	◎	◎	◎	◎	◎	◎	◎	◎	◎	◎	◎	◎	◎	◎	◎	◎	◎

HSSCo8, MULTI FLUTE LONG LENGTH ROUGHING & FINISHING

- HSSCo8, MULTI SCHNEIDEN LANG SCHRUPPSCHLICHTFRÄSER
- Fraise HSSCo8, multi-dents, ébauche et finition, longue
- MULTI TAGLIENTE, SERIE LUNGA PER SEMIFINITURA - HSSCo8



HSS Co8
DIN 844
NF
3-6
30°
DIN 1835B
~Ø20
Ø22~
P.784~787

Unit : mm

EDP No.		Mill Diameter	Shank Diameter	Length of Cut	Overall Length	No. of Flute
UNCOATED	TiAIN	k10	h6			
▲ E2768060	▲ EQ768060	6.0	6	24	68	3
▲ E2768080	▲ EQ768080	8.0	10	38	88	4
▲ E2768100	▲ EQ768100	10.0	10	45	95	4
▲ E2768120	▲ EQ768120	12.0	12	53	110	4
▲ E2768140	▲ EQ768140	14.0	12	53	110	4
▲ E2768160	▲ EQ768160	16.0	16	63	123	4
▲ E2768180	▲ EQ768180	18.0	16	63	123	4
▲ E2768200	▲ EQ768200	20.0	20	75	141	4
▲ E2768220	▲ EQ768220	22.0	20	75	141	5
▲ E2768250	▲ EQ768250	25.0	25	90	166	5
▲ E2768300	▲ EQ768300	30.0	25	90	166	5
-	▲ EQ768320	32.0	32	106	186	5
▲ E2768450	▲ EQ768450	45.0	40	125	217	6

- ▲ : Only available till stock runs out
- ▶ Other shank design on your request.
- ▶ TiN and TiCN Coatings are available on your request.

Tolerances according to DIN 7160 & 7161

	Tolerance range in μm					
	Nominal-Diameter in mm					
	from 1 to 3	over 3 to 6	over 6 to 10	over 10 to 18	over 18 to 30	over 30 to 50
k10	+40 0	+48 0	+58 0	+70 0	+84 0	+100 0
h6	0 -6	0 -8	0 -9	0 -11	0 -13	0 -16

◎ : Excellent ○ : Good

ISO Material Description	P										M			K							
	Non-alloy steel					Low alloy steel					High alloyed steel, and tool steel			Stainless steel			Grey cast iron		Nodular cast iron		Malleable cast iron
VDI 3323	1	2	3	4	5	6	7	8	9	10	11	12	13	14	15	16	17	18	19	20	
HRC	125	130	190	250	270	180	275	300	350	200	325	200	240	180	180	260	160	250	130	230	
Recommend	◎	◎	◎	◎	◎	◎	◎	◎	○	◎	◎	◎	◎	◎	◎	◎	◎	◎	◎	◎	
ISO Material Description	N									S						H					
	Aluminum-wrought alloy		Aluminum-cast, alloyed			Copper and Copper Alloys (Bronze / Brass)			Non Metallic Materials		Heat Resistant Super Alloys						Titanium Alloys		Hardened steel	Chilled Cast Iron	Hardened Cast Iron
VDI 3323	21	22	23	24	25	26	27	28	29	30	31	32	33	34	35	36	37	38	39	40	41
HRC	60	100	75	90	130	110	90	100			15	30	25	38	34	36	37	55	60	42	55
HB	60	100	75	90	130	110	90	100			200	280	250	350	320	400 Rm	1050 Rm	550	630	400	550
Recommend	○	○	○	○	○																



RECOMMENDED CUTTING CONDITIONS
EMPFOHLENE SCHNEIDPARAMETER

E9410 SERIES 2 FLUTE - SLOTTING

Vc = m/min.
fz = mm/tooth
RPM = rev./min.
FEED = mm/min.

ISO	VDI 3323	Material Description	Ae	Ap	Parameter	Diameter (Ø)														
						2.0	3.0	4.0	5.0	6.0	8.0	10.0	12.0	14.0	16.0	18.0	20.0	22.0	25.0	
P	1-2	Non-alloy steel	1.0D	0.5D	Vc	35	40	35	35	40	35	35	40	40	35	35	40	40		
					fz	0.003	0.007	0.013	0.019	0.025	0.039	0.05	0.063	0.061	0.079	0.092	0.098	0.098	0.1	
					RPM	5570	4244	2785	2228	2122	1393	1114	1061	909	696	619	557	579	509	
	3-4		1.0D	0.5D	Vc	30	30	30	30	30	30	30	30	30	30	30	30	30	30	
					fz	0.004	0.008	0.013	0.019	0.025	0.039	0.05	0.063	0.071	0.076	0.085	0.085	0.094	0.094	
					RPM	4775	3183	2387	1910	1592	1194	955	796	682	597	531	477	434	382	
	5		1.0D	0.5D	Vc	20	20	20	15	20	20	20	20	20	20	15	20	20	20	
					fz	0.004	0.006	0.013	0.02	0.025	0.039	0.049	0.06	0.067	0.079	0.092	0.098	0.098	0.098	
					RPM	3183	2122	1592	955	1061	796	637	531	455	398	265	318	289	255	
	6		1.0D	0.5D	Vc	35	40	35	35	40	35	35	40	40	35	35	40	40	40	
fz		0.003			0.007	0.013	0.019	0.025	0.039	0.05	0.063	0.061	0.079	0.092	0.098	0.098	0.1			
RPM		5570			4244	2785	2228	2122	1393	1114	1061	909	696	619	557	579	509			
7	1.0D	0.5D	Vc	30	30	30	30	30	30	30	30	30	30	30	30	30	30			
			fz	0.004	0.008	0.013	0.019	0.025	0.039	0.05	0.063	0.071	0.076	0.085	0.085	0.094	0.094			
			RPM	4775	3183	2387	1910	1592	1194	955	796	682	597	531	477	434	382			
8-9	1.0D	0.5D	Vc	20	20	20	15	20	20	20	20	20	15	20	20	20	20			
			fz	0.004	0.006	0.013	0.02	0.025	0.039	0.049	0.06	0.067	0.079	0.092	0.098	0.098	0.098			
			RPM	3183	2122	1592	955	1061	796	637	531	455	398	265	318	289	255			
10	1.0D	0.5D	Vc	35	40	35	35	40	35	35	40	40	35	35	40	40	40			
			fz	0.003	0.007	0.013	0.019	0.025	0.039	0.05	0.063	0.061	0.079	0.092	0.098	0.098	0.1			
			RPM	5570	4244	2785	2228	2122	1393	1114	1061	909	696	619	557	579	509			
11.1	1.0D	0.5D	Vc	20	20	20	15	20	20	20	20	20	15	20	20	20	20			
			fz	0.004	0.006	0.013	0.02	0.025	0.039	0.049	0.06	0.067	0.079	0.092	0.098	0.098	0.098			
			RPM	3183	2122	1592	955	1061	796	637	531	455	398	265	318	289	255			

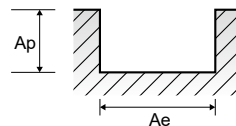

EP410 SERIES 2 FLUTE TiAIN COATED - SLOTTING

ISO	VDI 3323	Material Description	Ae	Ap	Parameter	Diameter (Ø)														
						2.0	3.0	4.0	5.0	6.0	8.0	10.0	12.0	14.0	16.0	18.0	20.0	22.0	25.0	
P	1-2	Non-alloy steel	1.0D	0.5D	Vc	50	55	50	50	55	50	50	55	55	50	50	55	55		
					fz	0.003	0.007	0.013	0.019	0.025	0.04	0.05	0.063	0.062	0.078	0.092	0.099	0.099	0.1	
					RPM	7958	5836	3979	3183	2918	1989	1592	1459	1251	995	884	796	796	700	
	3		1.0D	0.5D	Vc	45	40	40	45	40	40	45	40	45	40	40	45	40	45	
					fz	0.004	0.008	0.012	0.019	0.025	0.039	0.054	0.068	0.075	0.075	0.086	0.086	0.1	0.095	
					RPM	7162	4244	3183	2865	2122	1592	1432	1061	1023	796	707	716	579	573	
	4		1.0D	0.5D	Vc	57	68	76	109	106	124	155	144	153	119	122	123	116	109	
					fz	0.004	0.008	0.012	0.019	0.025	0.039	0.054	0.068	0.075	0.075	0.086	0.086	0.086	0.095	
					RPM	7162	4244	3183	2865	2122	1592	1432	1061	1023	796	707	716	579	573	
	5		1.0D	0.5D	Vc	25	25	25	25	25	25	25	25	25	25	20	25	25	25	
fz		0.004			0.006	0.013	0.019	0.025	0.038	0.047	0.061	0.071	0.075	0.096	0.096	0.096	0.102			
RPM		3979			2653	1989	1592	1326	995	796	663	568	497	354	398	362	318			
6	1.0D	0.5D	Vc	32	32	52	60	66	76	75	81	81	75	68	76	69	65			
			fz	0.004	0.006	0.013	0.019	0.025	0.038	0.047	0.061	0.071	0.075	0.096	0.096	0.096	0.102			
			RPM	3979	2653	1989	1592	1326	995	796	663	568	497	354	398	362	318			
7	1.0D	0.5D	Vc	25	25	25	25	25	25	25	25	25	25	20	25	25	25			
			fz	0.004	0.006	0.013	0.019	0.025	0.038	0.047	0.061	0.071	0.075	0.096	0.096	0.096	0.102			
			RPM	3979	2653	1989	1592	1326	995	796	663	568	497	354	398	362	318			
8-9	1.0D	0.5D	Vc	25	25	25	25	25	25	25	25	25	25	20	25	25	25			
			fz	0.004	0.006	0.013	0.019	0.025	0.038	0.047	0.061	0.071	0.075	0.096	0.096	0.096	0.102			
			RPM	3979	2653	1989	1592	1326	995	796	663	568	497	354	398	362	318			
10	1.0D	0.5D	Vc	32	32	52	60	66	76	75	81	81	75	68	76	69	65			
			fz	0.004	0.006	0.013	0.019	0.025	0.038	0.047	0.061	0.071	0.075	0.096	0.096	0.096	0.102			
			RPM	3979	2653	1989	1592	1326	995	796	663	568	497	354	398	362	318			
11.1	1.0D	0.5D	Vc	25	25	25	25	25	25	25	25	25	20	25	25	25	25			
			fz	0.004	0.006	0.013	0.019	0.025	0.038	0.047	0.061	0.071	0.075	0.096	0.096	0.096	0.102			
			RPM	3979	2653	1989	1592	1326	995	796	663	568	497	354	398	362	318			

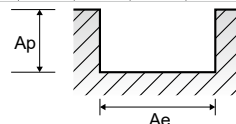

E9720 SERIES

MULTI FLUTE ROUGHING - SIDE CUTTING

Vc = m/min.
fz = mm/tooth
RPM = rev./min.
FEED = mm/min.

ISO	VDI 3323	Material Description	Ae	Ap	Parameter	Diameter (Ø)													
						6.0	8.0	10.0	12.0	14.0	16.0	18.0	20.0	22.0	25.0	28.0	30.0		
P	1-2	Non-alloy steel	0.5D	1.5D	Vc	45	45	45	40	45	45	45	40	45	40	45	40	45	40
					fz	0.011	0.018	0.027	0.042	0.046	0.051	0.058	0.066	0.093	0.083	0.087	0.096		
	RPM		2387	1790	1432	1061	1023	895	796	716	579	573	512	424					
	FEED		105	129	193	223	235	228	231	236	269	285	267	244					
	3-4		0.5D	1.5D	Vc	40	35	35	40	40	35	35	35	40	40	40	40		
					fz	0.009	0.017	0.027	0.036	0.04	0.051	0.06	0.064	0.075	0.07	0.074	0.083		
	RPM		2122	1393	1114	1061	909	696	619	557	579	509	455	424					
	FEED		76	95	150	191	182	178	186	178	217	214	202	211					
	5		0.5D	1.5D	Vc	20	20	20	20	20	20	15	20	20	20	20	20		
					fz	0.009	0.016	0.027	0.034	0.038	0.043	0.057	0.057	0.07	0.076	0.088	0.088		
	RPM		1061	796	637	531	455	398	265	318	289	255	227	212					
FEED	38	51	86	90	86	85	76	91	101	116	120	112							
6	0.5D	1.5D	Vc	45	45	45	40	45	45	45	45	40	45	40	40				
			fz	0.011	0.018	0.027	0.042	0.046	0.051	0.058	0.066	0.093	0.083	0.087	0.096				
RPM	2387	1790	1432	1061	1023	895	796	716	579	573	512	424							
FEED	105	129	193	223	235	228	231	236	269	285	267	244							
7	0.5D	1.5D	Vc	40	35	35	40	40	35	35	35	40	40	40	40				
			fz	0.009	0.017	0.027	0.036	0.04	0.051	0.06	0.064	0.075	0.07	0.074	0.083				
RPM	2122	1393	1114	1061	909	696	619	557	579	509	455	424							
FEED	76	95	150	191	182	178	186	178	217	214	202	211							
8-9	0.5D	1.5D	Vc	20	20	20	20	20	20	15	20	20	20	20	20				
			fz	0.009	0.016	0.027	0.034	0.038	0.043	0.057	0.057	0.07	0.076	0.088	0.088				
RPM	1061	796	637	531	455	398	265	318	289	255	227	212							
FEED	38	51	86	90	86	85	76	91	101	116	120	112							
10	0.5D	1.5D	Vc	45	45	45	40	45	45	45	45	40	45	40	40				
			fz	0.011	0.018	0.027	0.042	0.046	0.051	0.058	0.066	0.093	0.083	0.087	0.096				
RPM	2387	1790	1432	1061	1023	895	796	716	579	573	512	424							
FEED	105	129	193	223	235	228	231	236	269	285	267	244							
11.1	0.5D	1.5D	Vc	20	20	20	20	20	20	15	20	20	20	20	20				
			fz	0.009	0.016	0.027	0.034	0.038	0.043	0.057	0.057	0.07	0.076	0.088	0.088				
RPM	1061	796	637	531	455	398	265	318	289	255	227	212							
FEED	38	51	86	90	86	85	76	91	101	116	120	112							

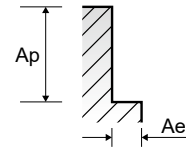

EP720 SERIES

MULTI FLUTE ROUGHING TiAIN COATED - SIDE CUTTING

ISO	VDI 3323	Material Description	Ae	Ap	Parameter	Diameter (Ø)												
						6.0	8.0	10.0	12.0	14.0	16.0	18.0	20.0	22.0	25.0	28.0	30.0	
P	1-2	Non-alloy steel	0.5D	1.5D	Vc	60	65	60	60	60	65	65	60	60	60	60	60	60
					fz	0.011	0.018	0.027	0.042	0.046	0.051	0.057	0.065	0.093	0.083	0.087	0.097	
	RPM		3183	2586	1910	1592	1364	1293	1149	955	868	764	682	637				
	FEED		140	186	258	334	314	330	328	310	404	380	356	371				
	3-4		0.5D	1.5D	Vc	55	50	50	55	55	50	50	50	55	55	55	55	
					fz	0.009	0.017	0.027	0.036	0.04	0.051	0.06	0.064	0.076	0.07	0.074	0.083	
	RPM		2918	1989	1592	1459	1251	995	884	796	796	700	625	584				
	FEED		105	135	215	263	250	254	265	255	302	294	278	291				
	5		0.5D	1.5D	Vc	25	25	25	25	30	25	25	25	30	25	25	25	
					fz	0.009	0.015	0.027	0.034	0.038	0.049	0.057	0.057	0.069	0.076	0.086	0.086	
	RPM		1326	995	796	663	682	497	442	398	434	318	284	265				
FEED	48	60	107	113	130	122	126	113	150	145	147	137						
6	0.5D	1.5D	Vc	60	65	60	60	60	65	65	60	60	60	60	60			
			fz	0.011	0.018	0.027	0.042	0.046	0.051	0.057	0.065	0.093	0.083	0.087	0.097			
RPM	3183	2586	1910	1592	1364	1293	1149	955	868	764	682	637						
FEED	140	186	258	334	314	330	328	310	404	380	356	371						
7	0.5D	1.5D	Vc	55	50	50	55	55	50	50	50	55	55	55	55			
			fz	0.009	0.017	0.027	0.036	0.04	0.051	0.06	0.064	0.076	0.07	0.074	0.083			
RPM	2918	1989	1592	1459	1251	995	884	796	796	700	625	584						
FEED	105	135	215	263	250	254	265	255	302	294	278	291						
8-9	0.5D	1.5D	Vc	25	25	25	25	30	25	25	25	30	25	25	25			
			fz	0.009	0.015	0.027	0.034	0.038	0.049	0.057	0.057	0.069	0.076	0.086	0.086			
RPM	1326	995	796	663	682	497	442	398	434	318	284	265						
FEED	48	60	107	113	130	122	126	113	150	145	147	137						
10	0.5D	1.5D	Vc	60	65	60	60	60	65	65	60	60	60	60	60			
			fz	0.011	0.018	0.027	0.042	0.046	0.051	0.057	0.065	0.093	0.083	0.087	0.097			
RPM	3183	2586	1910	1592	1364	1293	1149	955	868	764	682	637						
FEED	140	186	258	334	314	330	328	310	404	380	356	371						
11.1	0.5D	1.5D	Vc	25	25	25	25	30	25	25	25	30	25	25	25			
			fz	0.009	0.015	0.027	0.034	0.038	0.049	0.057	0.057	0.069	0.076	0.086	0.086			
RPM	1326	995	796	663	682	497	442	398	434	318	284	265						
FEED	48	60	107	113	130	122	126	113	150	145	147	137						

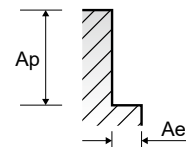



RECOMMENDED CUTTING CONDITIONS
EMPFOHLENE SCHNEIDPARAMETER

E3570 SERIES 2 FLUTE - SLOTTING

Vc = m/min.
fz = mm/tooth
RPM = rev./min.
FEED = mm/min.

Table with columns: ISO, VDI 3323, Material Description, Ae, Ap, Parameter, Diameter (Ø) [2.0, 3.0, 4.0, 5.0, 6.0, 8.0, 10.0, 12.0, 14.0, 16.0, 18.0, 20.0, 22.0, 25.0]. Rows include materials like Non-alloy steel, Low alloy steel, and High alloyed steel, tool steel.

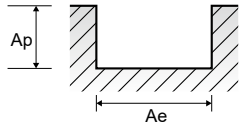

ER570 SERIES 2 FLUTE TiAIN COATED - SLOTTING

Table with columns: ISO, VDI 3323, Material Description, Ae, Ap, Parameter, Diameter (Ø) [2.0, 3.0, 4.0, 5.0, 6.0, 8.0, 10.0, 12.0, 14.0, 16.0, 18.0, 20.0, 22.0, 25.0]. Rows include materials like Non-alloy steel, Low alloy steel, and High alloyed steel, tool steel.

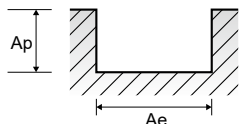

E3574 SERIES

4 FLUTE - SIDE CUTTING

Vc = m/min.
fz = mm/tooth
RPM = rev./min.
FEED = mm/min.

ISO	VDI 3323	Material Description	Ae	Ap	Parameter	Diameter (Ø)															
						2.0	3.0	4.0	5.0	6.0	8.0	10.0	12.0	14.0	16.0	18.0	20.0	22.0	25.0		
P	1-2	Non-alloy steel	0.1D	1.5D	Vc	30	35	30	30	35	30	30	35	35	30	30	30	35	35		
					fz	0.003	0.006	0.011	0.018	0.022	0.038	0.045	0.056	0.056	0.075	0.082	0.09	0.06	0.059		
	RPM		4775	3714	2387	1910	1857	1194	955	928	796	597	531	477	506	446					
	FEED		57	89	105	138	163	181	172	208	178	179	174	172	182	158					
	3-4		0.1D	1.5D	Vc	30	25	25	30	25	25	30	25	25	25	30	30	25			
					fz	0.003	0.006	0.009	0.014	0.019	0.029	0.036	0.046	0.054	0.058	0.064	0.064	0.048	0.048		
	5		0.1D	1.5D	Vc	15	15	15	15	15	15	15	15	20	15	15	15	15			
					fz	0.002	0.005	0.01	0.014	0.018	0.029	0.035	0.044	0.05	0.058	0.063	0.07	0.047	0.046		
	6		0.1D	1.5D	Vc	30	35	30	30	35	30	30	35	35	30	30	30	35	35		
					fz	0.003	0.006	0.011	0.018	0.022	0.038	0.045	0.056	0.056	0.075	0.082	0.09	0.06	0.059		
	7		0.1D	1.5D	Vc	30	25	25	30	25	25	30	25	25	25	30	30	25			
fz		0.003			0.006	0.009	0.014	0.019	0.029	0.036	0.046	0.054	0.058	0.064	0.064	0.048	0.048				
8-9	0.1D	1.5D	Vc	15	15	15	15	15	15	15	15	20	15	15	15	15					
			fz	0.002	0.005	0.01	0.014	0.018	0.029	0.035	0.044	0.05	0.058	0.063	0.07	0.047	0.046				
10	0.1D	1.5D	Vc	30	35	30	30	35	30	30	35	35	30	30	30	35	35				
			fz	0.003	0.006	0.011	0.018	0.022	0.038	0.045	0.056	0.056	0.075	0.082	0.09	0.06	0.059				
11.1	0.1D	1.5D	Vc	15	15	15	15	15	15	15	15	20	15	15	15	15					
			fz	0.002	0.005	0.01	0.014	0.018	0.029	0.035	0.044	0.05	0.058	0.063	0.07	0.047	0.046				

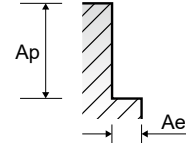

E3462 SERIES

3 FLUTE - SIDE CUTTING

ISO	VDI 3323	Material Description	Ae	Ap	Parameter	Diameter (Ø)							
						6.0	8.0	10.0	12.0	14.0	16.0	18.0	20.0
P	1-2	Non-alloy steel	0.3D	1.5D	Vc	40	40	40	40	35	35	30	25
					fz	0.017	0.022	0.028	0.04	0.054	0.071	0.12	0.158
	RPM		2122	1592	1273	1061	796	696	531	398			
	FEED		108	105	107	127	129	148	191	189			
	3-4		0.3D	1.5D	Vc	30	35	30	30	30	25	25	20
					fz	0.014	0.021	0.027	0.033	0.041	0.071	0.117	0.162
	5		0.3D	1.5D	Vc	25	25	25	25	20	20	20	15
					fz	0.013	0.015	0.021	0.028	0.037	0.058	0.108	0.133
	6		0.3D	1.5D	Vc	40	40	40	40	35	35	30	25
					fz	0.017	0.022	0.028	0.04	0.054	0.071	0.12	0.158
	7		0.3D	1.5D	Vc	30	35	30	30	30	25	25	20
fz		0.014			0.021	0.027	0.033	0.041	0.071	0.117	0.162		
8-9	0.3D	1.5D	Vc	25	25	25	25	20	20	20	15		
			fz	0.013	0.015	0.021	0.028	0.037	0.058	0.108	0.133		
10	0.3D	1.5D	Vc	40	40	40	40	35	35	30	25		
			fz	0.017	0.022	0.028	0.04	0.054	0.071	0.12	0.158		
11.1	0.3D	1.5D	Vc	25	25	25	25	20	20	20	15		
			fz	0.013	0.015	0.021	0.028	0.037	0.058	0.108	0.133		

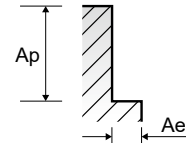



RECOMMENDED CUTTING CONDITIONS
EMPFOHLENE SCHNEIDPARAMETER

E2535, E2492 SERIES 2 FLUTE BALL NOSE

Vc = m/min.
fz = mm/tooth
RPM = rev./min.
FEED = mm/min.

ISO	VDI 3323	Material Description	Ae	Ap	Parameter	Diameter (Ø)								
						3.0	4.0	6.0	8.0	10.0	12.0	16.0	20.0	25.0
P	1	Non-alloy steel	0.7D	0.3D	Vc	40	40	40	40	40	40	40	40	40
					fz	0.011	0.018	0.031	0.05	0.069	0.085	0.094	0.117	0.13
					RPM	4244	3183	2122	1592	1273	1061	796	637	509
	2		0.7D	0.3D	Vc	30	30	30	30	30	30	30	30	30
					fz	0.01	0.017	0.026	0.044	0.06	0.066	0.083	0.085	0.088
					RPM	3183	2387	1592	1194	955	796	597	477	382
	3-4		0.7D	0.3D	Vc	20	20	20	20	20	15	20	20	15
					fz	0.008	0.013	0.023	0.036	0.054	0.061	0.079	0.083	0.091
					RPM	2122	1592	1061	796	637	398	398	318	191
	5		0.7D	0.3D	Vc	15	15	15	15	15	10	15	15	15
					fz	0.007	0.013	0.018	0.03	0.044	0.055	0.07	0.088	0.094
RPM		1592			1194	796	597	477	265	298	239	191		
6	0.7D	0.3D	Vc	30	30	30	30	30	30	30	30	30		
			fz	0.01	0.017	0.026	0.044	0.06	0.066	0.083	0.085	0.088		
			RPM	3183	2387	1592	1194	955	796	597	477	382		
7	0.7D	0.3D	Vc	20	20	20	20	20	15	20	20	15		
			fz	0.008	0.013	0.023	0.036	0.054	0.061	0.079	0.083	0.091		
			RPM	2122	1592	1061	796	637	398	398	318	191		
8-9	0.7D	0.3D	Vc	15	15	15	15	15	10	15	15	15		
			fz	0.007	0.013	0.018	0.03	0.044	0.055	0.07	0.088	0.094		
			RPM	1592	1194	796	597	477	265	298	239	191		
10	0.7D	0.3D	Vc	30	30	30	30	30	30	30	30	30		
			fz	0.01	0.017	0.026	0.044	0.06	0.066	0.083	0.085	0.088		
			RPM	3183	2387	1592	1194	955	796	597	477	382		
11.1	0.7D	0.3D	Vc	15	15	15	15	15	10	15	15	15		
			fz	0.007	0.013	0.018	0.03	0.044	0.055	0.07	0.088	0.094		
			RPM	1592	1194	796	597	477	265	298	239	191		
N	21-22	Aluminum-wrought alloy	0.7D	0.3D	Vc	105	100	105	100	100	95	100	100	100
					fz	0.01	0.016	0.025	0.044	0.056	0.068	0.075	0.088	0.096
					RPM	11141	7958	5570	3979	3183	2520	1989	1592	1273
23-24	Aluminum-cast, alloyed	0.7D	0.3D	Vc	68	65	68	65	65	62	65	65	65	
				fz	0.01	0.016	0.025	0.044	0.056	0.068	0.075	0.088	0.096	
				RPM	7215	5173	3608	2586	2069	1645	1293	1035	828	

※The FEED, in long & extra long types, should be reduced by around 50%

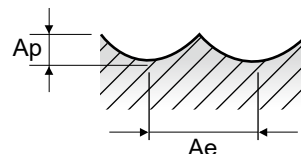

Vc = m/min.
fz = mm/tooth
RPM = rev./min.
FEED = mm/min.

EQ535, EQ492 SERIES **2 FLUTE BALL NOSE TiAlN COATED**

ISO	VDI 3323	Material Description	Ae	Ap	Parameter	Diameter (Ø)									
						3.0	4.0	6.0	8.0	10.0	12.0	16.0	20.0	25.0	
P	1	Non-alloy steel	0.7D	0.3D	Vc	60	55	60	55	55	55	55	55	55	55
					fz	0.011	0.018	0.031	0.05	0.069	0.086	0.095	0.115	0.129	
					RPM	6366	4377	3183	2188	1751	1459	1094	875	700	
	2		0.7D	0.3D	Vc	45	40	45	45	45	40	45	45	45	45
					fz	0.011	0.016	0.026	0.043	0.061	0.066	0.082	0.086	0.091	
					RPM	4775	3183	2387	1790	1432	1061	895	716	573	
	3-4		0.7D	0.3D	Vc	25	25	25	25	25	25	25	25	25	25
					fz	0.007	0.013	0.023	0.035	0.053	0.058	0.075	0.088	0.092	
					RPM	2653	1989	1326	995	796	663	497	398	318	
	5		0.7D	0.3D	Vc	37	52	61	70	84	77	75	70	59	
					fz	20	20	20	20	15	15	20	20	15	
RPM		2122			1592	1061	796	477	398	398	318	191			
6	0.7D	0.3D	Vc	34	41	38	46	43	45	57	53	38			
			fz	0.008	0.013	0.018	0.029	0.045	0.056	0.071	0.083	0.1			
			RPM	2122	1592	1061	796	477	398	398	318	191			
7	0.7D	0.3D	Vc	20	20	20	20	15	15	20	20	15			
			fz	0.008	0.013	0.018	0.029	0.045	0.056	0.071	0.083	0.1			
			RPM	2122	1592	1061	796	477	398	398	318	191			
8-9	0.7D	0.3D	Vc	34	41	38	46	43	45	57	53	38			
			fz	0.008	0.013	0.018	0.029	0.045	0.056	0.071	0.083	0.1			
			RPM	2122	1592	1061	796	477	398	398	318	191			
10	0.7D	0.3D	Vc	20	20	20	20	15	15	20	20	15			
			fz	0.008	0.013	0.018	0.029	0.045	0.056	0.071	0.083	0.1			
			RPM	2122	1592	1061	796	477	398	398	318	191			
11.1	0.7D	0.3D	Vc	45	40	45	45	45	40	45	45	45			
			fz	0.011	0.016	0.026	0.043	0.061	0.066	0.082	0.086	0.091			
			RPM	4775	3183	2387	1790	1432	1061	895	716	573			
N	21-22	Aluminum-wrought alloy	0.7D	0.3D	Vc	105	102	124	154	175	140	147	123	104	
					fz	0.011	0.016	0.026	0.043	0.061	0.066	0.082	0.086	0.091	
					RPM	4775	3183	2387	1790	1432	1061	895	716	573	
	23-24		0.7D	0.3D	Vc	20	20	20	20	15	15	20	20	15	
					fz	0.008	0.013	0.018	0.029	0.045	0.056	0.071	0.083	0.1	
					RPM	2122	1592	1061	796	477	398	398	318	191	
	21-22		0.7D	0.3D	Vc	34	41	38	46	43	45	57	53	38	
					fz	0.01	0.016	0.025	0.044	0.056	0.068	0.075	0.087	0.097	
					RPM	15385	11141	7958	5570	4456	3448	2785	2228	1783	
	23-24		0.7D	0.3D	Vc	94	91	98	91	91	85	91	91	91	
					fz	0.01	0.016	0.025	0.044	0.056	0.068	0.075	0.087	0.097	
RPM		9974			7242	5199	3621	2897	2255	1810	1448	1159			

※The FEED, in long & extra long types, should be reduced by around 50%

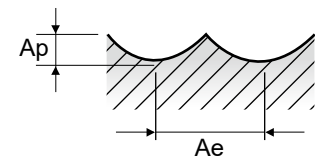



RECOMMENDED CUTTING CONDITIONS
EMPFOHLENE SCHNEIDPARAMETER

E2410, E2429, E2512 SERIES MULTI FLUTE BALL NOSE

Vc = m/min.
fz = mm/tooth
RPM = rev./min.
FEED = mm/min.

ISO	VDI 3323	Material Description	Ae	Ap	Parameter	Diameter (Ø)						
						6.0	8.0	10.0	12.0	16.0	20.0	25.0
P	1	Non-alloy steel	0.7D	0.3D	Vc	40	40	40	40	40	40	40
					fz	0.03	0.05	0.069	0.087	0.096	0.117	0.133
					RPM	2122	1592	1273	1061	796	637	509
	2		Vc	30	30	30	30	30	30	30		
			fz	0.026	0.044	0.06	0.067	0.083	0.087	0.088		
			RPM	1592	1194	955	796	597	477	382		
	3-4		Vc	20	20	20	15	20	20	15		
			fz	0.023	0.036	0.054	0.059	0.076	0.083	0.091		
			RPM	1061	796	637	398	398	318	191		
	5		Vc	15	15	15	15	15	15	15		
fz		0.019	0.03	0.042	0.052	0.067	0.083	0.094				
RPM		796	597	477	398	298	239	191				
6	Vc	30	30	30	30	30	30	30				
	fz	0.026	0.044	0.06	0.067	0.083	0.087	0.088				
	RPM	1592	1194	955	796	597	477	382				
7	Vc	20	20	20	15	20	20	15				
	fz	0.023	0.036	0.054	0.059	0.076	0.083	0.091				
	RPM	1061	796	637	398	398	318	191				
8-9	Vc	15	15	15	15	15	15	15				
	fz	0.019	0.03	0.042	0.052	0.067	0.083	0.094				
	RPM	796	597	477	398	298	239	191				
10	Vc	30	30	30	30	30	30	30				
	fz	0.026	0.044	0.06	0.067	0.083	0.087	0.088				
	RPM	1592	1194	955	796	597	477	382				
11.1	Vc	15	15	15	15	15	15	15				
	fz	0.019	0.03	0.042	0.052	0.067	0.083	0.094				
	RPM	796	597	477	398	298	239	191				
N	21-22	Aluminum-wrought alloy	0.7D	0.3D	Vc	105	100	100	95	100	100	100
					fz	0.025	0.044	0.056	0.068	0.075	0.088	0.097
					RPM	5570	3979	3183	2520	1989	1592	1273
23-24	Aluminum-cast, alloyed	0.7D	0.3D	Vc	68	65	65	62	65	65	65	
				fz	0.025	0.044	0.056	0.068	0.075	0.088	0.097	
				RPM	3608	2586	2069	1645	1293	1035	828	

※The FEED, in long & extra long types, should be reduced by around 50%

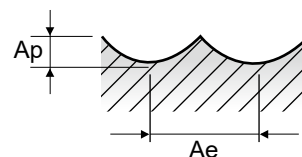

EQ410, EQ429, EQ512 SERIES

MULTI FLUTE BALL NOSE TiAlN COATED

Vc = m/min.
fz = mm/tooth
RPM = rev./min.
FEED = mm/min.

ISO	VDI 3323	Material Description	Ae	Ap	Parameter	Diameter (Ø)						
						6.0	8.0	10.0	12.0	16.0	20.0	25.0
P	1	Non-alloy steel	0.7D	0.3D	Vc	58	57	57	53	55	53	55
					fz	0.03	0.05	0.07	0.087	0.097	0.116	0.133
					RPM	3077	2268	1814	1406	1094	844	700
	2		0.7D	0.3D	Vc	45	43	44	41	43	44	43
					fz	0.026	0.044	0.06	0.068	0.082	0.086	0.088
					RPM	2387	1711	1401	1088	855	700	547
	3-4		0.7D	0.3D	Vc	26	25	25	25	25	25	24
					fz	0.024	0.035	0.052	0.056	0.073	0.088	0.094
					RPM	1379	995	796	663	497	398	306
	5		0.7D	0.3D	Vc	19	18	17	17	18	19	16
					fz	0.018	0.031	0.042	0.052	0.067	0.078	0.108
RPM		1008			716	541	451	358	302	204		
6	0.7D	0.3D	Vc	45	43	44	41	43	44	43		
			fz	0.026	0.044	0.06	0.068	0.082	0.086	0.088		
			RPM	2387	1711	1401	1088	855	700	547		
7	0.7D	0.3D	Vc	26	25	25	25	25	25	24		
			fz	0.024	0.035	0.052	0.056	0.073	0.088	0.094		
			RPM	1379	995	796	663	497	398	306		
8-9	0.7D	0.3D	Vc	19	18	17	17	18	19	16		
			fz	0.018	0.031	0.042	0.052	0.067	0.078	0.108		
			RPM	1008	716	541	451	358	302	204		
10	0.7D	0.3D	Vc	45	43	44	41	43	44	43		
			fz	0.026	0.044	0.06	0.068	0.082	0.086	0.088		
			RPM	2387	1711	1401	1088	855	700	547		
11.1	0.7D	0.3D	Vc	19	18	17	17	18	19	16		
			fz	0.018	0.031	0.042	0.052	0.067	0.078	0.108		
			RPM	1008	716	541	451	358	302	204		
N	21-22	Aluminum-wrought alloy	0.7D	0.3D	Vc	148	141	141	132	141	141	141
					fz	0.025	0.044	0.056	0.068	0.075	0.087	0.098
					RPM	7852	5610	4488	3501	2805	2244	1795
N	23-24	Aluminum-cast, alloyed	0.7D	0.3D	Vc	96	92	92	86	92	92	92
					fz	0.025	0.044	0.056	0.068	0.075	0.087	0.098
					RPM	5093	3661	2928	2281	1830	1464	1171

※The FEED, in long & extra long types, should be reduced by around 50%

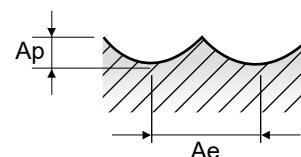

EL612 EL623 SERIES 1 FLUTE - **S**LOTTING

ISO	VDI 3323	Material Description	Ae	Ap	Parameter	Diameter (Ø)						
						3.0	4.0	5.0	6.0	7.0	8.0	10.0
N	21-22	Aluminum-wrought alloy	1.0D	0.5D (~Ø:0.2D)	Vc	188	226	220	207	220	214	220
					fz	0.055	0.053	0.054	0.055	0.055	0.053	0.054
					RPM	19947	17985	14006	10982	10004	8515	7003
N	23-24	Aluminum-cast, alloyed	1.0D	0.5D (~Ø:0.2D)	Vc	122	147	143	135	143	139	143
					fz	0.055	0.053	0.054	0.055	0.055	0.053	0.054
					RPM	12945	11698	9104	7162	6503	5531	4552

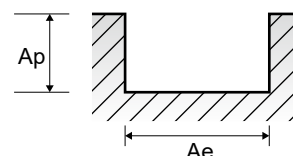

E2570, E2571, E2510 SERIES 2 FLUTE - SLOTTING

Vc = m/min.
fz = mm/tooth
RPM = rev./min.
FEED = mm/min.

ISO	VDI 3323	Material Description	Ae	Ap	Parameter	Diameter (Ø)							
						2.0	3.0	4.0	5.0	6.0	8.0	10.0	12.0
P	1	Non-alloy steel	1.0D	0.5D	Vc	35	35	35	35	35	35	35	35
					fz	0.004	0.008	0.013	0.02	0.025	0.036	0.045	0.061
					RPM	5570	3714	2785	2228	1857	1393	1114	928
	2		1.0D	0.5D	Vc	30	30	30	30	30	30	30	30
					fz	0.003	0.007	0.013	0.019	0.025	0.041	0.05	0.063
					RPM	4775	3183	2387	1910	1592	1194	955	796
	3-4		1.0D	0.5D	Vc	25	25	25	25	25	25	25	25
					fz	0.004	0.008	0.013	0.019	0.025	0.039	0.05	0.063
					RPM	3979	2653	1989	1592	1326	995	796	663
	5		1.0D	0.5D	Vc	15	15	15	15	15	15	15	15
fz		0.003			0.006	0.014	0.019	0.025	0.04	0.05	0.063		
RPM		2387			1592	1194	955	796	597	477	398		
6	1.0D	0.5D	Vc	30	30	30	30	30	30	30	30		
			fz	0.003	0.007	0.013	0.019	0.025	0.041	0.05	0.063		
			RPM	4775	3183	2387	1910	1592	1194	955	796		
7	1.0D	0.5D	Vc	25	25	25	25	25	25	25	25		
			fz	0.004	0.008	0.013	0.019	0.025	0.039	0.05	0.063		
			RPM	3979	2653	1989	1592	1326	995	796	663		
8-9	1.0D	0.5D	Vc	15	15	15	15	15	15	15	15		
			fz	0.003	0.006	0.014	0.019	0.025	0.04	0.05	0.063		
			RPM	2387	1592	1194	955	796	597	477	398		
10	1.0D	0.5D	Vc	30	30	30	30	30	30	30	30		
			fz	0.003	0.007	0.013	0.019	0.025	0.041	0.05	0.063		
			RPM	4775	3183	2387	1910	1592	1194	955	796		
11.1	1.0D	0.5D	Vc	15	15	15	15	15	15	15	15		
			fz	0.003	0.006	0.014	0.019	0.025	0.04	0.05	0.063		
			RPM	2387	1592	1194	955	796	597	477	398		
N	21-22	Aluminum-wrought alloy	1.0D	0.5D	Vc	75	105	100	100	105	100	95	95
					fz	0.007	0.011	0.018	0.025	0.028	0.049	0.065	0.076
					RPM	11937	11141	7958	6366	5570	3979	3024	2520
					FEED	167	245	286	318	312	390	393	383
23-24	Aluminum-cast, alloyed	1.0D	0.5D	Vc	49	68	65	65	68	65	62	62	
				fz	0.007	0.011	0.018	0.025	0.028	0.049	0.065	0.076	
				RPM	7799	7215	5173	4138	3608	2586	1974	1645	
				FEED	109	159	186	207	202	253	257	250	

※The FEED, in long & extra long types, should be reduced by around 50%

▶ NEXT PAGE

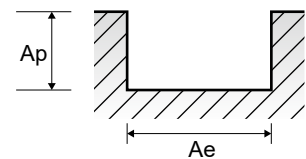

E2570, E2571, E2510 SERIES

2 FLUTE - SLOTTING

Vc = m/min.
fz = mm/tooth
RPM = rev./min.
FEED = mm/min.

VDI 3323	Parameter	14.0	16.0	18.0	20.0	22.0	25.0	28.0	30.0	32.0	36.0	40.0
1	Vc	35	35	35	35	35	35	35	35	35	35	35
	fz	0.069	0.079	0.079	0.089	0.1	0.1	0.1	0.1	0.1	0.097	0.107
	RPM	796	696	619	557	506	446	398	371	348	309	279
2	FEED	110	110	98	99	101	89	80	74	70	60	60
	Vc	30	30	30	30	30	30	30	30	30	30	30
	fz	0.064	0.08	0.09	0.1	0.1	0.1	0.1	0.097	0.098	0.1	0.114
3-4	RPM	682	597	531	477	434	382	341	318	298	265	239
	FEED	87	95	95	95	87	76	68	62	58	53	54
	Vc	25	25	25	25	25	25	25	25	20	25	25
5	fz	0.071	0.078	0.088	0.088	0.1	0.097	0.098	0.1	0.102	0.1	0.111
	RPM	568	497	442	398	362	318	284	265	199	221	199
	FEED	81	78	78	70	72	62	56	53	41	44	44
6	Vc	15	15	15	15	15	15	15	15	15	15	15
	fz	0.071	0.08	0.09	0.102	0.102	0.097	0.094	0.094	0.107	0.104	0.114
	RPM	341	298	265	239	217	191	171	159	149	133	119
7	FEED	48	48	48	49	44	37	32	30	32	28	27
	Vc	30	30	30	30	30	30	30	30	30	30	30
	fz	0.064	0.08	0.09	0.1	0.1	0.1	0.1	0.097	0.098	0.1	0.114
8-9	RPM	682	597	531	477	434	382	341	318	298	265	239
	FEED	87	95	95	95	87	76	68	62	58	53	54
	Vc	25	25	25	25	25	25	25	25	20	25	25
10	fz	0.071	0.078	0.088	0.088	0.1	0.097	0.098	0.1	0.102	0.1	0.111
	RPM	568	497	442	398	362	318	284	265	199	221	199
	FEED	81	78	78	70	72	62	56	53	41	44	44
11.1	Vc	15	15	15	15	15	15	15	15	15	15	15
	fz	0.071	0.08	0.09	0.102	0.102	0.097	0.094	0.094	0.107	0.104	0.114
	RPM	341	298	265	239	217	191	171	159	149	133	119
21 - 22	FEED	48	48	48	49	44	37	32	30	32	28	27
	Vc	95	100	100	100	95	95	95	105	100	100	100
	fz	0.08	0.088	0.097	0.1	0.107	0.117	0.123	0.123	0.12	0.122	0.125
23 - 24	RPM	2160	1989	1768	1592	1375	1210	1080	1114	995	884	796
	FEED	346	350	343	318	294	283	266	274	239	216	199
	Vc	62	65	65	65	62	62	62	68	65	65	65
23 - 24	fz	0.08	0.088	0.097	0.1	0.107	0.117	0.123	0.123	0.12	0.122	0.125
	RPM	1410	1293	1149	1035	897	789	705	722	647	575	517
	FEED	226	228	223	207	192	185	173	177	155	140	129

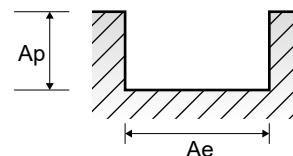



RECOMMENDED CUTTING CONDITIONS
EMPFOHLENE SCHNEIDPARAMETER

EQ570, EQ571, EQ510 SERIES 2 FLUTE TiAlN COATED - SLOTTING

Vc = m/min.
fz = mm/tooth
RPM = rev./min.
FEED = mm/min.

ISO	VDI 3323	Material Description	Ae	Ap	Parameter	Diameter (Ø)								
						2.0	3.0	4.0	5.0	6.0	8.0	10.0	12.0	
P	1	Non-alloy steel	1.0D	0.5D	Vc	50	45	50	50	45	50	50	45	
					fz	0.004	0.008	0.013	0.02	0.025	0.036	0.045	0.062	
					RPM	7958	4775	3979	3183	2387	1989	1592	1194	
	2		1.0D	0.5D	Vc	40	40	40	40	40	40	40	40	40
					fz	0.003	0.007	0.012	0.02	0.024	0.04	0.05	0.064	
					RPM	6366	4244	3183	2546	2122	1592	1273	1061	
	3-4		1.0D	0.5D	Vc	35	35	30	35	30	30	35	35	
					fz	0.004	0.008	0.013	0.019	0.025	0.04	0.05	0.061	
					RPM	5570	3714	2387	2228	1592	1194	1114	928	
	5		1.0D	0.5D	Vc	20	20	20	20	20	20	20	20	
					fz	0.003	0.007	0.013	0.02	0.025	0.041	0.05	0.064	
RPM		3183			2122	1592	1273	1061	796	637	531			
6	1.0D	0.5D	Vc	40	40	40	40	40	40	40	40			
			fz	0.003	0.007	0.012	0.02	0.024	0.04	0.05	0.064			
			RPM	6366	4244	3183	2546	2122	1592	1273	1061			
7	1.0D	0.5D	Vc	35	35	30	35	30	30	35	35			
			fz	0.004	0.008	0.013	0.019	0.025	0.04	0.05	0.061			
			RPM	5570	3714	2387	2228	1592	1194	1114	928			
8-9	1.0D	0.5D	Vc	20	20	20	20	20	20	20	20			
			fz	0.003	0.007	0.013	0.02	0.025	0.041	0.05	0.064			
			RPM	3183	2122	1592	1273	1061	796	637	531			
10	1.0D	0.5D	Vc	40	40	40	40	40	40	40	40			
			fz	0.003	0.007	0.012	0.02	0.024	0.04	0.05	0.064			
			RPM	6366	4244	3183	2546	2122	1592	1273	1061			
11.1	1.0D	0.5D	Vc	20	20	20	20	20	20	20	20			
			fz	0.003	0.007	0.013	0.02	0.025	0.041	0.05	0.064			
			RPM	3183	2122	1592	1273	1061	796	637	531			
N	21-22	Aluminum-wrought alloy	1.0D	0.5D	Vc	105	145	140	140	150	140	135	130	
					fz	0.007	0.011	0.018	0.025	0.028	0.049	0.064	0.076	
					RPM	16711	15385	11141	8913	7958	5570	4297	3448	
N	23-24	Aluminum-cast, alloyed	1.0D	0.5D	Vc	68	94	91	91	98	91	88	85	
					fz	0.007	0.011	0.018	0.025	0.028	0.049	0.064	0.076	
					RPM	10823	9974	7242	5793	5199	3621	2801	2255	

※The FEED, in long & extra long types, should be reduced by around 50%

▶ NEXT PAGE

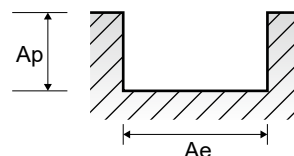

E2464, E2509 SERIES 2 FLUTE - SLOTTING

ISO	VDI 3323	Material Description	Ae	Ap	Parameter	Diameter (Ø)								
						3.0	6.0	8.0	10.0	12.0	14.0	16.0	18.0	20.0
N	21-22	Aluminum-wrought alloy	1.0D	0.5D	Vc	75	130	150	155	190	155	175	130	145
					fz	0.035	0.05	0.071	0.12	0.12	0.177	0.177	0.283	0.283
					RPM	7958	6897	5968	4934	5040	3524	3482	2299	2308
	23-24	Aluminum-cast, alloyed	1.0D	0.5D	Vc	49	85	98	101	124	101	114	85	94
					fz	0.035	0.05	0.071	0.12	0.12	0.177	0.177	0.283	0.283
					RPM	5199	4509	3899	3215	3289	2296	2268	1503	1496
FEED						364	451	554	772	789	813	803	851	847

▶ NEXT PAGE

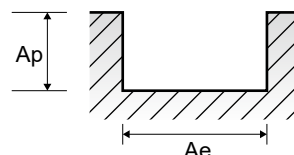

EQ570, EQ571, EQ510 SERIES 2 FLUTE TIALN COATED - SLOTTING

Vc = m/min.
fz = mm/tooth
RPM = rev./min.
FEED = mm/min.

VDI 3323	Parameter	Diameter (Ø)										
		14.0	16.0	18.0	20.0	22.0	25.0	28.0	30.0	32.0	36.0	40.0
1	Vc	50	50	50	50	50	50	50	45	50	50	50
	fz	0.07	0.078	0.078	0.088	0.1	0.096	0.1	0.1	0.1	0.094	0.106
	RPM	1137	995	884	796	723	637	568	477	497	442	398
2	Vc	45	40	40	40	45	45	45	40	40	40	40
	fz	0.063	0.078	0.089	0.096	0.096	0.1	0.1	0.094	0.094	0.1	0.117
	RPM	1023	796	707	637	651	573	512	424	398	354	318
3-4	Vc	35	35	30	35	35	35	35	30	30	35	30
	fz	0.069	0.077	0.091	0.091	0.1	0.094	0.094	0.1	0.108	0.092	0.11
	RPM	796	696	531	557	506	446	398	371	298	309	239
5	Vc	20	20	20	20	20	20	20	20	20	15	20
	fz	0.07	0.081	0.093	0.108	0.108	0.1	0.1	0.1	0.1	0.117	0.117
	RPM	455	398	354	318	289	255	227	212	199	133	159
6	Vc	45	40	40	40	45	45	45	40	40	40	40
	fz	0.063	0.078	0.089	0.096	0.096	0.1	0.1	0.094	0.094	0.1	0.117
	RPM	1023	796	707	637	651	573	512	424	398	354	318
7	Vc	35	35	30	35	35	35	35	30	30	35	30
	fz	0.069	0.077	0.091	0.091	0.1	0.094	0.094	0.1	0.108	0.092	0.11
	RPM	796	696	531	557	506	446	398	371	298	309	239
8-9	Vc	20	20	20	20	20	20	20	20	20	15	20
	fz	0.07	0.081	0.093	0.108	0.108	0.1	0.1	0.1	0.1	0.117	0.117
	RPM	455	398	354	318	289	255	227	212	199	133	159
10	Vc	45	40	40	40	45	45	45	40	40	40	40
	fz	0.063	0.078	0.089	0.096	0.096	0.1	0.1	0.094	0.094	0.1	0.117
	RPM	1023	796	707	637	651	573	512	424	398	354	318
11.1	Vc	20	20	20	20	20	20	20	20	20	15	20
	fz	0.07	0.081	0.093	0.108	0.108	0.1	0.1	0.1	0.1	0.117	0.117
	RPM	455	398	354	318	289	255	227	212	199	133	159
21 - 22	Vc	135	140	140	140	135	135	135	145	140	140	140
	fz	0.079	0.088	0.098	0.1	0.108	0.115	0.123	0.123	0.12	0.124	0.127
	RPM	3069	2785	2476	2228	1953	1719	1535	1538	1393	1238	1114
23 - 24	Vc	88	91	91	91	88	88	88	94	91	91	91
	fz	0.079	0.088	0.098	0.1	0.108	0.115	0.123	0.123	0.12	0.124	0.127
	RPM	2001	1810	1609	1448	1273	1120	1000	997	905	805	724
	FEED	316	319	315	290	275	258	246	245	217	200	184

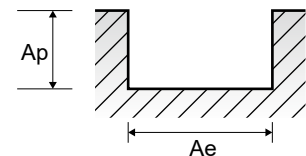

E2464, E2509 SERIES 2 FLUTE - SITE CUTTING

ISO	VDI 3323	Material Description	Ae	Ap	Parameter	Diameter (Ø)								
						3.0	6.0	8.0	10.0	12.0	14.0	16.0	18.0	20.0
N	21-22	Aluminum-wrought alloy	Ø3~Ø10=0.25D Ø12~Ø20=0.5D	1.0D	Vc	75	130	150	155	190	155	175	130	145
					fz	0.046	0.064	0.092	0.15	0.15	0.229	0.229	0.37	0.37
					RPM	7958	6897	5968	4934	5040	3524	3482	2299	2308
	23-24	Aluminum-cast, alloyed	Ø3~Ø10=0.25D Ø12~Ø20=0.5D	1.0D	Vc	49	85	98	101	124	101	114	85	94
					fz	0.046	0.064	0.092	0.15	0.15	0.229	0.229	0.37	0.37
					RPM	5199	4509	3899	3215	3289	2296	2268	1503	1496
	FEED	478	577	717	964	987	1052	1039	1112	1107				

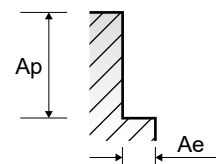

E2572, E2573, E2516, E2553, E2554, E2551, E2552 SERIES

Vc = m/min.
fz = mm/tooth
RPM = rev./min.
FEED = mm/min.

3 FLUTE - SLOTTING

ISO	VDI 3323	Material Description	Ae	Ap	Parameter	Diameter (Ø)								
						2.0	3.0	4.0	5.0	6.0	8.0	10.0	12.0	
P	1	Non-alloy steel	1.0D	0.5D	Vc	35	35	35	35	35	35	35	35	35
					fz	0.002	0.005	0.007	0.012	0.015	0.021	0.027	0.037	
					RPM	5570	3714	2785	2228	1857	1393	1114	928	
	2		1.0D	0.5D	Vc	30	30	30	30	30	30	30	30	30
					fz	0.002	0.004	0.007	0.01	0.014	0.021	0.026	0.033	
					RPM	4775	3183	2387	1910	1592	1194	955	796	
	3-4		1.0D	0.5D	Vc	25	25	25	25	25	25	25	25	25
					fz	0.002	0.003	0.006	0.008	0.011	0.019	0.023	0.029	
					RPM	3979	2653	1989	1592	1326	995	796	663	
	5		1.0D	0.5D	Vc	15	15	15	15	15	15	15	15	15
					fz	0.002	0.003	0.006	0.007	0.01	0.018	0.022	0.029	
RPM		2387			1592	1194	955	796	597	477	398			
6	1.0D	0.5D	Vc	30	30	30	30	30	30	30	30	30		
			fz	0.002	0.004	0.007	0.01	0.014	0.021	0.026	0.033			
			RPM	4775	3183	2387	1910	1592	1194	955	796			
7	1.0D	0.5D	Vc	25	25	25	25	25	25	25	25	25		
			fz	0.002	0.003	0.006	0.008	0.011	0.019	0.023	0.029			
			RPM	3979	2653	1989	1592	1326	995	796	663			
8-9	1.0D	0.5D	Vc	15	15	15	15	15	15	15	15	15		
			fz	0.002	0.003	0.006	0.007	0.01	0.018	0.022	0.029			
			RPM	2387	1592	1194	955	796	597	477	398			
10	1.0D	0.5D	Vc	30	30	30	30	30	30	30	30	30		
			fz	0.002	0.004	0.007	0.01	0.014	0.021	0.026	0.033			
			RPM	4775	3183	2387	1910	1592	1194	955	796			
11.1	1.0D	0.5D	Vc	15	15	15	15	15	15	15	15	15		
			fz	0.002	0.003	0.006	0.007	0.01	0.018	0.022	0.029			
			RPM	2387	1592	1194	955	796	597	477	398			
N	21-22	Aluminum-wrought alloy	1.0D	0.5D	Vc	75	105	100	100	105	100	95	95	
					fz	0.003	0.005	0.008	0.011	0.013	0.022	0.029	0.035	
					RPM	11937	11141	7958	6366	5570	3979	3024	2520	
					FEED	107	167	191	210	217	263	263	265	
23-24	Aluminum-cast, alloyed	1.0D	0.5D	Vc	49	68	65	65	68	65	62	62		
				fz	0.003	0.005	0.008	0.011	0.013	0.022	0.029	0.035		
				RPM	7799	7215	5173	4138	3608	2586	1974	1645		
				FEED	70	108	124	137	141	171	172	173		

※The FEED, in long & extra long types, should be reduced by around 50%

▶ NEXT PAGE

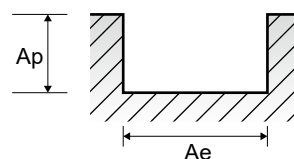

Vc = m/min.
fz = mm/tooth
RPM = rev./min.
FEED = mm/min.

E2572, E2573, E2516, E2553, E2554, E2551, E2552 SERIES

3 FLUTE - SLOTTING

VDI 3323	Parameter	Diameter (Ø)											
		14.0	16.0	18.0	20.0	22.0	25.0	28.0	30.0	32.0	35.0	36.0	40.0
1	Vc	35	35	35	35	35	35	35	35	35	35	35	35
	fz	0.042	0.048	0.048	0.054	0.06	0.059	0.058	0.057	0.057	0.057	0.059	0.065
	RPM	796	696	619	557	506	446	398	371	348	318	309	279
2	FEED	100	100	89	90	91	79	69	64	60	54	55	54
	Vc	30	30	30	30	30	30	30	30	30	30	30	30
	fz	0.033	0.042	0.047	0.052	0.052	0.054	0.052	0.054	0.054	0.051	0.053	0.061
3-4	RPM	682	597	531	477	434	382	341	318	298	273	265	239
	FEED	68	75	75	74	68	62	53	52	48	42	42	44
	Vc	25	25	25	25	25	25	25	25	20	25	25	25
5	fz	0.033	0.037	0.042	0.042	0.048	0.043	0.042	0.04	0.045	0.04	0.042	0.046
	RPM	568	497	442	398	362	318	284	265	199	227	221	199
	FEED	56	55	56	50	52	41	36	32	27	27	28	27
6	Vc	15	15	15	15	15	15	15	15	15	15	15	15
	fz	0.033	0.036	0.04	0.045	0.045	0.037	0.042	0.042	0.048	0.038	0.042	0.045
	RPM	341	298	265	239	217	191	171	159	149	136	133	119
7	FEED	34	32	32	32	29	21	21	20	21	16	17	16
	Vc	30	30	30	30	30	30	30	30	30	30	30	30
	fz	0.033	0.042	0.047	0.052	0.052	0.054	0.052	0.054	0.054	0.051	0.053	0.061
8-9	RPM	682	597	531	477	434	382	341	318	298	273	265	239
	FEED	68	75	75	74	68	62	53	52	48	42	42	44
	Vc	25	25	25	25	25	25	25	25	20	25	25	25
10	fz	0.033	0.037	0.042	0.042	0.048	0.043	0.042	0.04	0.045	0.04	0.042	0.046
	RPM	568	497	442	398	362	318	284	265	199	227	221	199
	FEED	56	55	56	50	52	41	36	32	27	27	28	27
11.1	Vc	15	15	15	15	15	15	15	15	15	15	15	15
	fz	0.033	0.036	0.04	0.045	0.045	0.037	0.042	0.042	0.048	0.038	0.042	0.045
	RPM	341	298	265	239	217	191	171	159	149	136	133	119
21-22	FEED	34	32	32	32	29	21	21	20	21	16	17	16
	Vc	95	100	100	100	95	95	95	105	100	105	100	100
	fz	0.036	0.04	0.044	0.046	0.048	0.053	0.055	0.055	0.053	0.053	0.056	0.054
23-24	RPM	2160	1989	1768	1592	1375	1210	1080	1114	995	955	884	796
	FEED	233	239	233	220	198	192	178	184	158	152	149	129
	Vc	62	65	65	65	62	62	62	68	65	68	65	65
23-24	fz	0.036	0.04	0.044	0.046	0.048	0.053	0.055	0.055	0.053	0.053	0.056	0.054
	RPM	1410	1293	1149	1035	897	789	705	722	647	618	575	517
	FEED	152	155	152	143	129	126	116	119	103	98	97	84

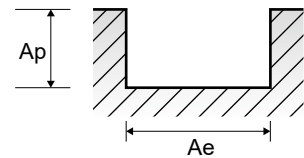

E2572, E2573, E2516, E2553, E2554, E2551, E2552 SERIES

Vc = m/min.
fz = mm/tooth
RPM = rev./min.
FEED = mm/min.

3 FLUTE - SIDE CUTTING

ISO	VDI 3323	Material Description	Ae	Ap	Parameter	Diameter (Ø)								
						2.0	3.0	4.0	5.0	6.0	8.0	10.0	12.0	
P	1	Non-alloy steel	0.1D	1.5D	Vc	35	35	35	35	35	35	35	35	35
					fz	0.004	0.008	0.013	0.02	0.025	0.036	0.045	0.061	
					RPM	5570	3714	2785	2228	1857	1393	1114	928	
	2		0.1D	1.5D	Vc	30	30	30	30	30	30	30	30	30
					fz	0.003	0.006	0.011	0.018	0.023	0.036	0.044	0.056	
					RPM	4775	3183	2387	1910	1592	1194	955	796	
	3-4		0.1D	1.5D	Vc	25	25	25	25	25	25	25	25	25
					fz	0.003	0.006	0.009	0.014	0.018	0.03	0.038	0.048	
					RPM	3979	2653	1989	1592	1326	995	796	663	
	5		0.1D	1.5D	Vc	15	15	15	15	15	15	15	15	15
					fz	0.002	0.004	0.009	0.013	0.019	0.03	0.037	0.046	
RPM		2387			1592	1194	955	796	597	477	398			
6	0.1D	1.5D	Vc	30	30	30	30	30	30	30	30	30		
			fz	0.003	0.006	0.011	0.018	0.023	0.036	0.044	0.056			
			RPM	4775	3183	2387	1910	1592	1194	955	796			
7	0.1D	1.5D	Vc	25	25	25	25	25	25	25	25	25		
			fz	0.003	0.006	0.009	0.014	0.018	0.03	0.038	0.048			
			RPM	3979	2653	1989	1592	1326	995	796	663			
8-9	0.1D	1.5D	Vc	15	15	15	15	15	15	15	15	15		
			fz	0.002	0.004	0.009	0.013	0.019	0.03	0.037	0.046			
			RPM	2387	1592	1194	955	796	597	477	398			
10	0.1D	1.5D	Vc	30	30	30	30	30	30	30	30	30		
			fz	0.003	0.006	0.011	0.018	0.023	0.036	0.044	0.056			
			RPM	4775	3183	2387	1910	1592	1194	955	796			
11.1	0.1D	1.5D	Vc	15	15	15	15	15	15	15	15	15		
			fz	0.002	0.004	0.009	0.013	0.019	0.03	0.037	0.046			
			RPM	2387	1592	1194	955	796	597	477	398			
21-22	0.1D	1.5D	Vc	75	105	100	100	105	100	95	95			
			fz	0.005	0.008	0.014	0.019	0.021	0.037	0.048	0.057			
			RPM	11937	11141	7958	6366	5570	3979	3024	2520			
23-24	0.1D	1.5D	Vc	49	68	65	65	68	65	62	62			
			fz	0.005	0.008	0.014	0.019	0.021	0.037	0.048	0.057			
			RPM	7799	7215	5173	4138	3608	2586	1974	1645			
					FEED	117	173	217	236	227	287	284	281	

※The FEED, in long & extra long types, should be reduced by around 50%

▶ NEXT PAGE

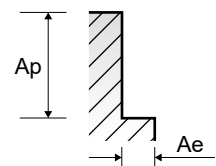

Vc = m/min.
fz = mm/tooth
RPM = rev./min.
FEED = mm/min.

E2572, E2573, E2516, E2553, E2554, E2551, E2552 SERIES

3 FLUTE - SIDE CUTTING

VDI 3323	Parameter	Diameter (Ø)											
		14.0	16.0	18.0	20.0	22.0	25.0	28.0	30.0	32.0	35.0	36.0	40.0
1	Vc	35	35	35	35	35	35	35	35	35	35	35	35
	fz	0.069	0.079	0.079	0.089	0.1	0.1	0.1	0.1	0.1	0.099	0.097	0.107
	RPM	796	696	619	557	506	446	398	371	348	318	309	279
2	FEED	165	165	147	149	152	134	119	111	104	95	90	89
	Vc	30	30	30	30	30	30	30	30	30	30	30	30
	fz	0.057	0.071	0.08	0.089	0.089	0.092	0.09	0.086	0.089	0.083	0.087	0.098
3-4	RPM	682	597	531	477	434	382	341	318	298	273	265	239
	FEED	117	127	127	127	116	105	92	82	80	68	69	70
	Vc	25	25	25	25	25	25	25	25	20	25	25	25
5	fz	0.054	0.059	0.067	0.067	0.076	0.07	0.071	0.073	0.076	0.071	0.075	0.083
	RPM	568	497	442	398	362	318	284	265	199	227	221	199
	FEED	92	88	89	80	82	67	61	58	45	48	50	50
6	Vc	15	15	15	15	15	15	15	15	15	15	15	15
	fz	0.052	0.06	0.067	0.076	0.076	0.065	0.063	0.063	0.071	0.064	0.069	0.076
	RPM	341	298	265	239	217	191	171	159	149	136	133	119
7	FEED	53	54	53	54	49	37	32	30	32	26	27	27
	Vc	30	30	30	30	30	30	30	30	30	30	30	30
	fz	0.057	0.071	0.08	0.089	0.089	0.092	0.09	0.086	0.089	0.083	0.087	0.098
8-9	RPM	682	597	531	477	434	382	341	318	298	273	265	239
	FEED	117	127	127	127	116	105	92	82	80	68	69	70
	Vc	25	25	25	25	25	25	25	25	20	25	25	25
10	fz	0.054	0.059	0.067	0.067	0.076	0.07	0.071	0.073	0.076	0.071	0.075	0.083
	RPM	568	497	442	398	362	318	284	265	199	227	221	199
	FEED	92	88	89	80	82	67	61	58	45	48	50	50
11.1	Vc	15	15	15	15	15	15	15	15	15	15	15	15
	fz	0.052	0.06	0.067	0.076	0.076	0.065	0.063	0.063	0.071	0.064	0.069	0.076
	RPM	341	298	265	239	217	191	171	159	149	136	133	119
21-22	FEED	53	54	53	54	49	37	32	30	32	26	27	27
	Vc	95	100	100	100	95	95	95	105	100	105	100	100
	fz	0.061	0.067	0.074	0.075	0.081	0.089	0.091	0.091	0.09	0.091	0.093	0.092
23-24	RPM	2160	1989	1768	1592	1375	1210	1080	1114	995	955	884	796
	FEED	395	400	393	358	334	323	295	304	269	261	247	220
	Vc	62	65	65	65	62	62	62	68	65	68	65	65
23-24	fz	0.061	0.067	0.074	0.075	0.081	0.089	0.091	0.091	0.09	0.091	0.093	0.092
	RPM	1410	1293	1149	1035	897	789	705	722	647	618	575	517
	FEED	258	260	255	233	218	211	192	197	175	169	160	143

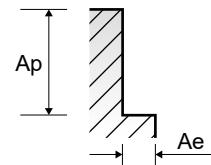

EQ572, EQ573, EQ516, EQ553, EQ554, EQ551, EQ552 SERIES

Vc = m/min.
fz = mm/tooth
RPM = rev./min.
FEED = mm/min.

3 FLUTE TiAIN COATED - SLOTTING

ISO	VDI 3323	Material Description	Ae	Ap	Parameter	Diameter (Ø)							
						2.0	3.0	4.0	5.0	6.0	8.0	10.0	12.0
P	1	Non-alloy steel	1.0D	0.5D	Vc	50	45	50	50	45	50	45	50
					fz	0.002	0.005	0.007	0.012	0.015	0.021	0.028	0.036
					RPM	7958	4775	3979	3183	2387	1989	1432	1326
	FEED		48	72	84	115	107	125	120	143			
	2		Vc	40	40	40	40	40	40	40	40		
			fz	0.002	0.004	0.006	0.01	0.014	0.022	0.028	0.033		
			RPM	6366	4244	3183	2546	2122	1592	1273	1061		
	FEED		38	51	57	76	89	105	107	105			
	3-4		Vc	35	35	30	35	30	35	35	35		
			fz	0.002	0.003	0.005	0.008	0.011	0.018	0.023	0.028		
			RPM	5570	3714	2387	2228	1592	1393	1114	928		
FEED	33	33	36	53	53	75	77	78					
5	Vc	20	20	20	20	20	20	20	20				
	fz	0.002	0.003	0.007	0.008	0.011	0.017	0.021	0.03				
	RPM	3183	2122	1592	1273	1061	796	637	531				
FEED	19	19	33	31	35	41	40	48					
6	Vc	40	40	40	40	40	40	40	40				
	fz	0.002	0.004	0.006	0.01	0.014	0.022	0.028	0.033				
	RPM	6366	4244	3183	2546	2122	1592	1273	1061				
FEED	38	51	57	76	89	105	107	105					
7	Vc	35	35	30	35	30	35	35	35				
	fz	0.002	0.003	0.005	0.008	0.011	0.018	0.023	0.028				
	RPM	5570	3714	2387	2228	1592	1393	1114	928				
FEED	33	33	36	53	53	75	77	78					
8-9	Vc	20	20	20	20	20	20	20	20				
	fz	0.002	0.003	0.007	0.008	0.011	0.017	0.021	0.03				
	RPM	3183	2122	1592	1273	1061	796	637	531				
FEED	19	19	33	31	35	41	40	48					
10	Vc	40	40	40	40	40	40	40	40				
	fz	0.002	0.004	0.006	0.01	0.014	0.022	0.028	0.033				
	RPM	6366	4244	3183	2546	2122	1592	1273	1061				
FEED	38	51	57	76	89	105	107	105					
11.1	Vc	20	20	20	20	20	20	20	20				
	fz	0.002	0.003	0.007	0.008	0.011	0.017	0.021	0.03				
	RPM	3183	2122	1592	1273	1061	796	637	531				
FEED	19	19	33	31	35	41	40	48					
N	21-22	Aluminum-wrought alloy	1.0D	0.5D	Vc	105	145	140	140	145	140	135	130
					fz	0.003	0.005	0.008	0.011	0.012	0.021	0.029	0.034
	RPM		16711	15385	11141	8913	7692	5570	4297	3448			
	FEED		150	231	267	294	277	351	374	352			
23-24	Aluminum-cast, alloyed	1.0D	0.5D	Vc	68	94	91	91	94	91	88	85	
				fz	0.003	0.005	0.008	0.011	0.012	0.021	0.029	0.034	
RPM		10823	9974	7242	5793	4987	3621	2801	2255				
FEED		97	150	174	191	180	228	244	230				

※The FEED, in long & extra long types, should be reduced by around 50%

▶ NEXT PAGE

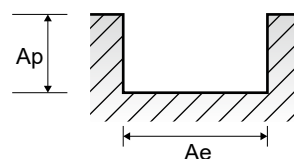

EQ572, EQ573, EQ516, EQ553, EQ554, EQ551, EQ552 SERIES

Vc = m/min.
fz = mm/tooth
RPM = rev./min.
FEED = mm/min.

3 FLUTE TiAIN COATED - SLOTTING

VDI 3323	Parameter	Diameter (Ø)											
		14.0	16.0	18.0	20.0	22.0	25.0	28.0	30.0	32.0	35.0	36.0	40.0
1	Vc	50	50	50	50	50	50	50	45	50	50	50	50
	fz	0.042	0.048	0.047	0.053	0.06	0.058	0.06	0.058	0.058	0.059	0.058	0.064
	RPM	1137	995	884	796	723	637	568	477	497	455	442	398
2	FEED	143	143	125	127	130	111	102	83	87	80	77	76
	Vc	45	40	40	40	45	45	45	40	40	40	40	40
	fz	0.034	0.043	0.048	0.053	0.053	0.054	0.051	0.054	0.056	0.056	0.052	0.059
3-4	RPM	1023	796	707	637	651	573	512	424	398	364	354	318
	FEED	104	103	102	101	104	93	78	69	67	61	55	56
	Vc	35	30	30	35	35	35	35	35	30	30	30	30
5	fz	0.032	0.037	0.042	0.042	0.048	0.043	0.043	0.038	0.043	0.04	0.042	0.047
	RPM	796	597	531	557	506	446	398	371	298	273	265	239
	FEED	76	66	67	70	73	57	51	42	38	33	33	34
6	Vc	20	20	20	20	20	20	20	20	20	20	20	20
	fz	0.034	0.034	0.038	0.043	0.043	0.04	0.045	0.045	0.05	0.046	0.039	0.044
	RPM	455	398	354	318	289	255	227	212	199	182	177	159
7	FEED	46	41	40	41	37	31	31	29	30	25	21	21
	Vc	45	40	40	40	45	45	45	40	40	40	40	40
	fz	0.034	0.043	0.048	0.053	0.053	0.054	0.051	0.054	0.056	0.056	0.052	0.059
8-9	RPM	1023	796	707	637	651	573	512	424	398	364	354	318
	FEED	104	103	102	101	104	93	78	69	67	61	55	56
	Vc	35	30	30	35	35	35	35	35	30	30	30	30
10	fz	0.032	0.037	0.042	0.042	0.048	0.043	0.043	0.038	0.043	0.04	0.042	0.047
	RPM	796	597	531	557	506	446	398	371	298	273	265	239
	FEED	76	66	67	70	73	57	51	42	38	33	33	34
11.1	Vc	20	20	20	20	20	20	20	20	20	20	20	20
	fz	0.034	0.034	0.038	0.043	0.043	0.04	0.045	0.045	0.05	0.046	0.039	0.044
	RPM	455	398	354	318	289	255	227	212	199	182	177	159
21-22	FEED	46	41	40	41	37	31	31	29	30	25	21	21
	Vc	135	140	140	140	135	135	130	140	140	145	140	140
	fz	0.037	0.04	0.045	0.047	0.048	0.053	0.056	0.056	0.054	0.055	0.056	0.055
23-24	RPM	3069	2785	2476	2228	1953	1719	1478	1485	1393	1319	1238	1114
	FEED	341	334	334	314	281	273	248	250	226	218	208	184
	Vc	88	91	91	91	88	88	85	91	91	94	91	91
23-24	fz	0.037	0.04	0.045	0.047	0.048	0.053	0.056	0.056	0.054	0.055	0.056	0.055
	RPM	2001	1810	1609	1448	1273	1120	966	966	905	855	805	724
	FEED	222	217	217	204	183	178	162	162	147	141	135	119

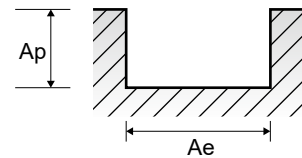

EQ572, EQ573, EQ516, EQ553, EQ554, EQ551, EQ552 SERIES

Vc = m/min.
fz = mm/tooth
RPM = rev./min.
FEED = mm/min.

3 FLUTE TiAIN COATED - SIDE CUTTING

ISO	VDI 3323	Material Description	Ae	Ap	Parameter	Diameter (Ø)								
						2.0	3.0	4.0	5.0	6.0	8.0	10.0	12.0	
P	1	Non-alloy steel	0.1D	1.5D	Vc	50	45	50	50	45	50	45	50	
					fz	0.004	0.007	0.012	0.02	0.025	0.035	0.047	0.059	
					RPM	7958	4775	3979	3183	2387	1989	1432	1326	
	FEED		95	100	143	191	179	209	202	235				
	2		0.1D	1.5D	Vc	40	40	40	40	40	40	40	40	40
					fz	0.003	0.006	0.011	0.017	0.023	0.038	0.044	0.058	
					RPM	6366	4244	3183	2546	2122	1592	1273	1061	
	FEED		57	76	105	130	146	181	168	185				
	3-4		0.1D	1.5D	Vc	35	35	30	35	30	35	35	35	35
					fz	0.003	0.006	0.009	0.014	0.018	0.028	0.038	0.047	
					RPM	5570	3714	2387	2228	1592	1393	1114	928	
FEED	50	67	64	94	86	117	127	131						
5	0.1D	1.5D	Vc	20	20	20	20	20	20	20	20	20		
			fz	0.002	0.005	0.009	0.013	0.018	0.03	0.037	0.045			
			RPM	3183	2122	1592	1273	1061	796	637	531			
FEED	19	32	43	50	57	72	71	72						
6	0.1D	1.5D	Vc	40	40	40	40	40	40	40	40	40		
			fz	0.003	0.006	0.011	0.017	0.023	0.038	0.044	0.058			
			RPM	6366	4244	3183	2546	2122	1592	1273	1061			
FEED	57	76	105	130	146	181	168	185						
7	0.1D	1.5D	Vc	35	35	30	35	30	35	35	35	35		
			fz	0.003	0.006	0.009	0.014	0.018	0.028	0.038	0.047			
			RPM	5570	3714	2387	2228	1592	1393	1114	928			
FEED	50	67	64	94	86	117	127	131						
8-9	0.1D	1.5D	Vc	20	20	20	20	20	20	20	20	20		
			fz	0.002	0.005	0.009	0.013	0.018	0.03	0.037	0.045			
			RPM	3183	2122	1592	1273	1061	796	637	531			
FEED	19	32	43	50	57	72	71	72						
10	0.1D	1.5D	Vc	40	40	40	40	40	40	40	40	40		
			fz	0.003	0.006	0.011	0.017	0.023	0.038	0.044	0.058			
			RPM	6366	4244	3183	2546	2122	1592	1273	1061			
FEED	57	76	105	130	146	181	168	185						
11.1	0.1D	1.5D	Vc	20	20	20	20	20	20	20	20	20		
			fz	0.002	0.005	0.009	0.013	0.018	0.03	0.037	0.045			
			RPM	3183	2122	1592	1273	1061	796	637	531			
FEED	19	32	43	50	57	72	71	72						
N	21-22	Aluminum-wrought alloy	0.1D	1.5D	Vc	105	145	140	140	145	140	135	130	
					fz	0.005	0.008	0.014	0.019	0.021	0.037	0.049	0.057	
	RPM		16711	15385	11141	8913	7692	5570	4297	3448				
	FEED		251	369	468	508	485	618	632	590				
23-24	0.1D	1.5D	Vc	68	94	91	91	94	91	88	85			
			fz	0.005	0.008	0.014	0.019	0.021	0.037	0.049	0.057			
RPM	10823	9974	7242	5793	4987	3621	2801	2255						
FEED	162	239	304	330	314	402	412	386						

※The FEED, in long & extra long types, should be reduced by around 50%

▶ NEXT PAGE

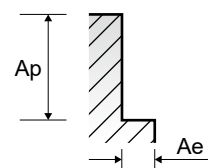

EQ572, EQ573, EQ516, EQ553, EQ554, EQ551, EQ552 SERIES

Vc = m/min.
fz = mm/tooth
RPM = rev./min.
FEED = mm/min.

3 FLUTE TiAIN COATED - SIDE CUTTING

VDI 3323	Parameter	Diameter (Ø)											
		14.0	16.0	18.0	20.0	22.0	25.0	28.0	30.0	32.0	35.0	36.0	40.0
1	Vc	50	50	50	50	50	50	50	45	50	50	50	50
	fz	0.07	0.078	0.08	0.09	0.1	0.101	0.101	0.099	0.099	0.096	0.097	0.107
	RPM	1137	995	884	796	723	637	568	477	497	455	442	398
2	FEED	239	233	212	215	217	193	172	142	148	131	129	128
	Vc	45	40	40	40	45	45	45	40	40	40	40	40
	fz	0.058	0.073	0.081	0.09	0.09	0.092	0.088	0.085	0.09	0.088	0.086	0.097
3-4	RPM	1023	796	707	637	651	573	512	424	398	364	354	318
	FEED	178	174	172	172	176	158	135	108	107	96	91	93
	Vc	35	30	30	35	35	35	35	35	30	30	30	30
5	fz	0.053	0.058	0.065	0.065	0.075	0.07	0.073	0.071	0.075	0.075	0.077	0.087
	RPM	796	597	531	557	506	446	398	371	298	273	265	239
	FEED	127	104	103	109	114	94	87	79	67	61	61	62
6	Vc	20	20	20	20	20	20	20	20	20	20	20	20
	fz	0.051	0.06	0.067	0.075	0.075	0.067	0.061	0.061	0.067	0.065	0.069	0.078
	RPM	455	398	354	318	289	255	227	212	199	182	177	159
7	FEED	70	72	71	72	65	51	42	39	40	35	37	37
	Vc	45	40	40	40	45	45	45	40	40	40	40	40
	fz	0.058	0.073	0.081	0.09	0.09	0.092	0.088	0.085	0.09	0.088	0.086	0.097
8-9	RPM	1023	796	707	637	651	573	512	424	398	364	354	318
	FEED	178	174	172	172	176	158	135	108	107	96	91	93
	Vc	35	30	30	35	35	35	35	35	30	30	30	30
10	fz	0.053	0.058	0.065	0.065	0.075	0.07	0.073	0.071	0.075	0.075	0.077	0.087
	RPM	796	597	531	557	506	446	398	371	298	273	265	239
	FEED	127	104	103	109	114	94	87	79	67	61	61	62
11.1	Vc	20	20	20	20	20	20	20	20	20	20	20	20
	fz	0.051	0.06	0.067	0.075	0.075	0.067	0.061	0.061	0.067	0.065	0.069	0.078
	RPM	455	398	354	318	289	255	227	212	199	182	177	159
21-22	FEED	70	72	71	72	65	51	42	39	40	35	37	37
	Vc	45	40	40	40	45	45	45	40	40	40	40	40
	fz	0.058	0.073	0.081	0.09	0.09	0.092	0.088	0.085	0.09	0.088	0.086	0.097
23-24	RPM	1023	796	707	637	651	573	512	424	398	364	354	318
	FEED	178	174	172	172	176	158	135	108	107	96	91	93
	Vc	20	20	20	20	20	20	20	20	20	20	20	20
21	fz	0.051	0.06	0.067	0.075	0.075	0.067	0.061	0.061	0.067	0.065	0.069	0.078
	RPM	455	398	354	318	289	255	227	212	199	182	177	159
	FEED	70	72	71	72	65	51	42	39	40	35	37	37
22	Vc	135	140	140	140	135	135	130	140	140	145	140	140
	fz	0.06	0.067	0.075	0.076	0.082	0.088	0.093	0.093	0.09	0.092	0.093	0.094
	RPM	3069	2785	2476	2228	1953	1719	1478	1485	1393	1319	1238	1114
23	FEED	552	560	557	508	481	454	412	414	376	364	345	314
	Vc	88	91	91	91	88	88	85	91	91	94	91	91
	fz	0.06	0.067	0.075	0.076	0.082	0.088	0.093	0.093	0.09	0.092	0.093	0.094
24	RPM	2001	1810	1609	1448	1273	1120	966	966	905	855	805	724
	FEED	360	364	362	330	313	296	270	269	244	236	224	204

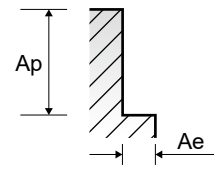

E2574, E2575, E2576, E2577, E2597, E2598, E2776 SERIES

Vc = m/min.
fz = mm/tooth
RPM = rev./min.
FEED = mm/min.

MULTI FLUTE - SIDE CUTTING

ISO	VDI 3323	Material Description	Ae	Ap	Parameter	Diameter (Ø)						
						2.0	3.0	4.0	5.0	6.0	8.0	10.0
P	1	Non-alloy steel	0.1D	1.5D	Vc	35	35	35	35	35	35	35
					fz	0.004	0.008	0.013	0.02	0.025	0.036	0.045
					RPM	5570	3714	2785	2228	1857	1393	1114
	2		Vc	30	30	30	30	30	30	30		
			fz	0.003	0.006	0.011	0.017	0.023	0.036	0.044		
			RPM	4775	3183	2387	1910	1592	1194	955		
	3-4		Vc	25	25	25	25	25	25	25		
			fz	0.003	0.006	0.009	0.014	0.019	0.029	0.038		
			RPM	3979	2653	1989	1592	1326	995	796		
	5		Vc	15	15	15	15	15	15	15		
			fz	0.002	0.005	0.01	0.014	0.019	0.029	0.036		
RPM		2387	1592	1194	955	796	597	477				
6	Vc	30	30	30	30	30	30	30				
	fz	0.003	0.006	0.011	0.017	0.023	0.036	0.044				
	RPM	4775	3183	2387	1910	1592	1194	955				
7	Vc	25	25	25	25	25	25	25				
	fz	0.003	0.006	0.009	0.014	0.019	0.029	0.038				
	RPM	3979	2653	1989	1592	1326	995	796				
8-9	Vc	15	15	15	15	15	15	15				
	fz	0.002	0.005	0.01	0.014	0.019	0.029	0.036				
	RPM	2387	1592	1194	955	796	597	477				
10	Vc	30	30	30	30	30	30	30				
	fz	0.003	0.006	0.011	0.017	0.023	0.036	0.044				
	RPM	4775	3183	2387	1910	1592	1194	955				
11.1	Vc	15	15	15	15	15	15	15				
	fz	0.002	0.005	0.01	0.014	0.019	0.029	0.036				
	RPM	2387	1592	1194	955	796	597	477				
N	21-22	Aluminum-wrought alloy	0.1D	1.5D	Vc	75	105	100	100	105	100	95
					fz	0.005	0.009	0.014	0.019	0.021	0.036	0.048
					RPM	11937	11141	7958	6366	5570	3979	3024
					FEED	239	401	446	484	468	573	581
23-24	Aluminum-cast, alloyed	0.1D	1.5D	Vc	49	68	65	65	68	65	62	
				fz	0.005	0.009	0.014	0.019	0.021	0.036	0.048	
				RPM	7799	7215	5173	4138	3608	2586	1974	
				FEED	156	260	290	314	303	372	379	

※The FEED, in long & extra long types, should be reduced by around 50%

▶ NEXT PAGE

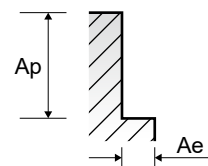

E2574, E2575, E2576, E2577, E2597, E2598, E2776 SERIES

Vc = m/min.
fz = mm/tooth
RPM = rev./min.
FEED = mm/min.

MULTI FLUTE - SIDE CUTTING

VDI 3323	Parameter	Diameter (Ø)											
		12.0	14.0	16.0	18.0	20.0	22.0	25.0	28.0	30.0	32.0	36.0	40.0
1	Vc	35	35	35	35	35	35	35	35	35	35	35	35
	fz	0.061	0.069	0.079	0.079	0.089	0.067	0.067	0.067	0.067	0.067	0.065	0.071
	RPM	928	796	696	619	557	506	446	398	371	348	309	279
2	FEED	227	220	220	196	198	204	179	160	149	140	121	119
	Vc	30	30	30	30	30	30	30	30	30	30	30	30
	fz	0.056	0.057	0.071	0.08	0.089	0.059	0.06	0.06	0.059	0.06	0.06	0.068
3-4	RPM	796	682	597	531	477	434	382	341	318	298	265	239
	FEED	178	156	170	170	170	154	138	123	113	107	95	97
	Vc	25	25	25	25	25	25	25	25	25	20	25	25
5	fz	0.048	0.054	0.058	0.066	0.066	0.05	0.048	0.048	0.05	0.049	0.05	0.056
	RPM	663	568	497	442	398	362	318	284	265	199	221	199
	FEED	127	123	115	117	105	109	92	82	80	58	66	67
6	Vc	15	15	15	15	15	15	15	15	15	15	15	15
	fz	0.047	0.054	0.058	0.065	0.074	0.049	0.046	0.047	0.047	0.054	0.049	0.053
	RPM	398	341	298	265	239	217	191	171	159	149	133	119
7	FEED	75	74	69	69	71	64	53	48	45	48	39	38
	Vc	30	30	30	30	30	30	30	30	30	30	30	30
	fz	0.056	0.057	0.071	0.08	0.089	0.059	0.06	0.06	0.059	0.06	0.06	0.068
8-9	RPM	796	682	597	531	477	434	382	341	318	298	265	239
	FEED	178	156	170	170	170	154	138	123	113	107	95	97
	Vc	25	25	25	25	25	25	25	25	25	20	25	25
10	fz	0.048	0.054	0.058	0.066	0.066	0.05	0.048	0.048	0.05	0.049	0.05	0.056
	RPM	663	568	497	442	398	362	318	284	265	199	221	199
	FEED	127	123	115	117	105	109	92	82	80	58	66	67
11.1	Vc	15	15	15	15	15	15	15	15	15	15	15	15
	fz	0.047	0.054	0.058	0.065	0.074	0.049	0.046	0.047	0.047	0.054	0.049	0.053
	RPM	398	341	298	265	239	217	191	171	159	149	133	119
21-22	FEED	75	74	69	69	71	64	53	48	45	48	39	38
	Vc	95	95	100	100	100	95	95	95	105	100	100	100
	fz	0.057	0.06	0.066	0.074	0.075	0.054	0.058	0.061	0.061	0.06	0.061	0.063
23-24	RPM	2520	2160	1989	1768	1592	1375	1210	1080	1114	995	884	796
	FEED	575	518	525	523	477	445	421	395	408	358	324	301
	Vc	62	62	65	65	65	62	62	62	68	65	65	65
23-24	fz	0.057	0.06	0.066	0.074	0.075	0.054	0.058	0.061	0.061	0.06	0.061	0.063
	RPM	1645	1410	1293	1149	1035	897	789	705	722	647	575	517
	FEED	375	338	341	340	310	291	275	258	264	233	210	196

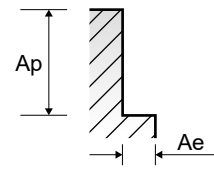

EQ574, EQ575, EQ576, EQ577, EQ597, EQ598, EQ776 SERIES

Vc = m/min.
fz = mm/tooth
RPM = rev./min.
FEED = mm/min.

MULTI FLUTE TiAIN COATED - SIDE CUTTING

ISO	VDI 3323	Material Description	Ae	Ap	Parameter	Diameter (Ø)							
						2.0	3.0	4.0	5.0	6.0	8.0	10.0	12.0
P	1	Non-alloy steel	0.1D	1.5D	Vc	50	45	50	50	45	50	50	45
					fz	0.004	0.008	0.013	0.02	0.025	0.036	0.045	0.062
					RPM	7958	4775	3979	3183	2387	1989	1592	1194
					FEED	127	153	207	255	239	286	286	296
	2		Vc	40	40	40	40	40	40	40	40		
			fz	0.003	0.006	0.011	0.018	0.023	0.036	0.045	0.057		
			RPM	6366	4244	3183	2546	2122	1592	1273	1061		
			FEED	76	102	140	183	195	229	229	242		
	3-4		Vc	35	35	30	35	30	30	35	35		
			fz	0.003	0.006	0.009	0.014	0.018	0.029	0.039	0.047		
			RPM	5570	3714	2387	2228	1592	1194	1114	928		
FEED		67	89	86	125	115	138	174	175				
5	Vc	20	20	20	20	20	20	20	20				
	fz	0.002	0.004	0.01	0.014	0.019	0.028	0.035	0.048				
	RPM	3183	2122	1592	1273	1061	796	637	531				
	FEED	25	34	64	71	81	89	89	102				
6	Vc	40	40	40	40	40	40	40	40				
	fz	0.003	0.006	0.011	0.018	0.023	0.036	0.045	0.057				
	RPM	6366	4244	3183	2546	2122	1592	1273	1061				
	FEED	76	102	140	183	195	229	229	242				
7	Vc	35	35	30	35	30	30	35	35				
	fz	0.003	0.006	0.009	0.014	0.018	0.029	0.039	0.047				
	RPM	5570	3714	2387	2228	1592	1194	1114	928				
	FEED	67	89	86	125	115	138	174	175				
8-9	Vc	20	20	20	20	20	20	20	20				
	fz	0.002	0.004	0.01	0.014	0.019	0.028	0.035	0.048				
	RPM	3183	2122	1592	1273	1061	796	637	531				
	FEED	25	34	64	71	81	89	89	102				
10	Vc	40	40	40	40	40	40	40	40				
	fz	0.003	0.006	0.011	0.018	0.023	0.036	0.045	0.057				
	RPM	6366	4244	3183	2546	2122	1592	1273	1061				
	FEED	76	102	140	183	195	229	229	242				
11.1	Vc	20	20	20	20	20	20	20	20				
	fz	0.002	0.004	0.01	0.014	0.019	0.028	0.035	0.048				
	RPM	3183	2122	1592	1273	1061	796	637	531				
	FEED	25	34	64	71	81	89	89	102				
N	21-22	Aluminum-wrought alloy	0.1D	1.5D	Vc	105	145	140	140	150	140	135	130
					fz	0.005	0.009	0.014	0.019	0.021	0.036	0.048	0.057
	RPM		16711	15385	11141	8913	7958	5570	4297	3448			
	FEED		334	554	624	677	668	802	825	786			
23-24	Aluminum-cast, alloyed	Vc	68	94	91	91	98	91	88	85			
		fz	0.005	0.009	0.014	0.019	0.021	0.036	0.048	0.057			
		RPM	10823	9974	7242	5793	5199	3621	2801	2255			
		FEED	216	359	406	440	437	521	538	514			

※ The FEED, in long & extra long types, should be reduced by around 50%

▶ NEXT PAGE

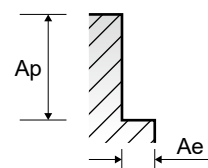

EQ574, EQ575, EQ576, EQ577, EQ597, EQ598, EQ776 SERIES

Vc = m/min.
fz = mm/tooth
RPM = rev./min.
FEED = mm/min.

MULTI FLUTE TIAIN COATED - SIDE CUTTING

VDI 3323	Parameter	14.0	16.0	18.0	20.0	22.0	25.0	28.0	30.0	32.0	36.0	40.0
1	Vc	50	50	50	50	50	50	50	45	50	50	50
	fz	0.07	0.078	0.078	0.088	0.067	0.064	0.068	0.065	0.065	0.063	0.071
	RPM	1137	995	884	796	723	637	568	477	497	442	398
	FEED	318	310	276	280	291	244	232	186	194	167	170
2	Vc	45	40	40	40	45	45	45	40	40	40	40
	fz	0.056	0.07	0.08	0.087	0.058	0.062	0.058	0.057	0.058	0.06	0.069
	RPM	1023	796	707	637	651	573	512	424	398	354	318
	FEED	229	223	226	222	227	213	178	145	138	127	132
3-4	Vc	35	35	30	35	35	35	35	35	30	35	30
	fz	0.053	0.056	0.066	0.066	0.048	0.046	0.046	0.05	0.05	0.047	0.057
	RPM	796	696	531	557	506	446	398	371	298	309	239
	FEED	169	156	140	147	146	123	110	111	90	87	82
5	Vc	20	20	20	20	20	20	20	20	20	15	20
	fz	0.053	0.056	0.064	0.075	0.05	0.047	0.054	0.054	0.054	0.056	0.056
	RPM	455	398	354	318	289	255	227	212	199	133	159
	FEED	96	89	91	95	87	72	74	69	64	45	53
6	Vc	45	40	40	40	45	45	45	40	40	40	40
	fz	0.056	0.07	0.08	0.087	0.058	0.062	0.058	0.057	0.058	0.06	0.069
	RPM	1023	796	707	637	651	573	512	424	398	354	318
	FEED	229	223	226	222	227	213	178	145	138	127	132
7	Vc	35	35	30	35	35	35	35	35	30	35	30
	fz	0.053	0.056	0.066	0.066	0.048	0.046	0.046	0.05	0.05	0.047	0.057
	RPM	796	696	531	557	506	446	398	371	298	309	239
	FEED	169	156	140	147	146	123	110	111	90	87	82
8-9	Vc	20	20	20	20	20	20	20	20	20	15	20
	fz	0.053	0.056	0.064	0.075	0.05	0.047	0.054	0.054	0.054	0.056	0.056
	RPM	455	398	354	318	289	255	227	212	199	133	159
	FEED	96	89	91	95	87	72	74	69	64	45	53
10	Vc	45	40	40	40	45	45	45	40	40	40	40
	fz	0.056	0.07	0.08	0.087	0.058	0.062	0.058	0.057	0.058	0.06	0.069
	RPM	1023	796	707	637	651	573	512	424	398	354	318
	FEED	229	223	226	222	227	213	178	145	138	127	132
11.1	Vc	20	20	20	20	20	20	20	20	20	15	20
	fz	0.053	0.056	0.064	0.075	0.05	0.047	0.054	0.054	0.054	0.056	0.056
	RPM	455	398	354	318	289	255	227	212	199	133	159
	FEED	96	89	91	95	87	72	74	69	64	45	53
21 - 22	Vc	135	140	140	140	135	135	135	145	140	140	140
	fz	0.06	0.066	0.074	0.074	0.054	0.058	0.06	0.06	0.06	0.061	0.064
	RPM	3069	2785	2476	2228	1953	1719	1535	1538	1393	1238	1114
	FEED	737	735	733	660	633	598	552	554	501	453	428
23 - 24	Vc	88	91	91	91	88	88	88	94	91	91	91
	fz	0.06	0.066	0.074	0.074	0.054	0.058	0.06	0.06	0.06	0.061	0.064
	RPM	2001	1810	1609	1448	1273	1120	1000	997	905	805	724
	FEED	480	478	476	429	413	390	360	359	326	294	278

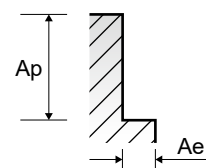



RECOMMENDED CUTTING CONDITIONS
EMPFOHLENE SCHNEIDPARAMETER

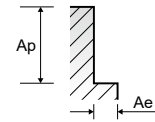

Vc = m/min.
fz = mm/tooth
RPM = rev./min.
FEED = mm/min.

E2461, E2462, E2463 SERIES

MULTI FLUTE - SIDE CUTTING

ISO	VDI 3323	Material Description	Ae	Ap	Parameter	Diameter (Ø)					
						2.0	3.0	4.0	5.0	6.0	8.0
P	1-2	Non-alloy steel	0.3D	1.5D	Vc	30	35	30	30	35	30
					fz	0.004	0.007	0.012	0.019	0.016	0.026
	RPM		4775	3714	2387	1910	1857	1194			
	FEED		38	52	57	73	89	93			
	3-4		0.3D	1.5D	Vc	30	30	25	30	25	25
					fz	0.003	0.006	0.01	0.015	0.014	0.022
	5		0.3D	1.5D	Vc	15	15	15	15	15	15
					fz	0.002	0.006	0.01	0.015	0.013	0.022
	6		0.3D	1.5D	Vc	30	35	30	30	35	30
					fz	0.004	0.007	0.012	0.019	0.016	0.026
	7		0.3D	1.5D	Vc	4775	3714	2387	1910	1857	1194
FEED		38			52	57	73	89	93		
8-9	0.3D	1.5D	Vc	30	30	25	30	25	25		
			fz	0.003	0.006	0.01	0.015	0.014	0.022		
10	0.3D	1.5D	Vc	4775	3714	2387	1910	1857	1194		
			FEED	38	52	57	73	89	93		
11.1	0.3D	1.5D	Vc	15	15	15	15	15	15		
			fz	0.002	0.006	0.01	0.015	0.013	0.022		
11.1	0.3D	1.5D	Vc	2387	1592	1194	955	796	597		
			FEED	10	19	24	29	31	39		

▶ NEXT PAGE

EQ461, EQ462, EQ463 SERIES

MULTI FLUTE TiAIN COATED - SIDE CUTTING

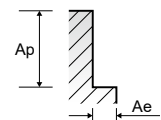

ISO	VDI 3323	Material Description	Ae	Ap	Parameter	Diameter (Ø)					
						2.0	3.0	4.0	5.0	6.0	8.0
P	1-2	Non-alloy steel	0.3D	1.5D	Vc	45	45	45	45	50	40
					fz	0.004	0.007	0.012	0.019	0.016	0.027
	RPM		7162	4775	3581	2865	2653	1592			
	FEED		57	67	86	109	127	129			
	3-4		0.3D	1.5D	Vc	40	35	35	40	35	35
					fz	0.003	0.006	0.01	0.015	0.014	0.021
	5		0.3D	1.5D	Vc	6366	3714	2785	2546	1857	1393
					FEED	38	45	56	76	78	88
	6		0.3D	1.5D	Vc	20	25	20	20	25	20
					fz	0.002	0.006	0.01	0.014	0.013	0.022
	7		0.3D	1.5D	Vc	3183	2653	1592	1273	1326	796
FEED		13			32	32	36	52	53		
8-9	0.3D	1.5D	Vc	45	45	45	45	50	40		
			fz	0.004	0.007	0.012	0.019	0.016	0.027		
10	0.3D	1.5D	Vc	7162	4775	3581	2865	2653	1592		
			FEED	57	67	86	109	127	129		
11.1	0.3D	1.5D	Vc	40	35	35	40	35	35		
			fz	0.003	0.006	0.01	0.015	0.014	0.021		
11.1	0.3D	1.5D	Vc	6366	3714	2785	2546	1857	1393		
			FEED	38	45	56	76	78	88		
11.1	0.3D	1.5D	Vc	20	25	20	20	25	20		
			fz	0.002	0.006	0.01	0.014	0.013	0.022		
11.1	0.3D	1.5D	Vc	3183	2653	1592	1273	1326	796		
			FEED	13	32	32	36	52	53		
11.1	0.3D	1.5D	Vc	45	45	45	45	50	40		
			fz	0.004	0.007	0.012	0.019	0.016	0.027		
11.1	0.3D	1.5D	Vc	7162	4775	3581	2865	2653	1592		
			FEED	57	67	86	109	127	129		
11.1	0.3D	1.5D	Vc	20	25	20	20	25	20		
			fz	0.002	0.006	0.01	0.014	0.013	0.022		
11.1	0.3D	1.5D	Vc	3183	2653	1592	1273	1326	796		
			FEED	13	32	32	36	52	53		

▶ NEXT PAGE

**RECOMMENDED CUTTING CONDITIONS
EMPHOHLENE SCHNEIDPARAMETER**

E2461, E2462, E2463 SERIES

MULTI FLUTE - SIDE CUTTING

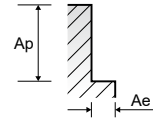

Vc = m/min.
fz = mm/tooth
RPM = rev./min.
FEED = mm/min.

VDI 3323	Parameter	Diameter (Ø)									
		10.0	12.0	14.0	16.0	18.0	20.0	22.0	25.0	28.0	30.0
1-2	Vc	30	35	35	30	30	30	35	35	35	35
	fz	0.032	0.041	0.04	0.053	0.058	0.063	0.048	0.047	0.047	0.046
	RPM	955	928	796	597	531	477	506	446	398	371
	FEED	92	114	95	95	92	90	97	84	75	68
3-4	Vc	30	25	25	25	25	30	30	25	25	25
	fz	0.026	0.033	0.039	0.043	0.048	0.048	0.041	0.039	0.042	0.04
	RPM	955	663	568	497	442	477	434	318	284	265
	FEED	74	66	67	64	64	69	71	50	48	42
5	Vc	15	15	20	15	15	15	15	15	15	15
	fz	0.027	0.033	0.038	0.044	0.048	0.053	0.04	0.038	0.035	0.035
	RPM	477	398	455	298	265	239	217	191	171	159
	FEED	39	39	52	39	38	38	35	29	24	22
6	Vc	30	35	35	30	30	30	35	35	35	35
	fz	0.032	0.041	0.04	0.053	0.058	0.063	0.048	0.047	0.047	0.046
	RPM	955	928	796	597	531	477	506	446	398	371
	FEED	92	114	95	95	92	90	97	84	75	68
7	Vc	30	25	25	25	25	30	30	25	25	25
	fz	0.026	0.033	0.039	0.043	0.048	0.048	0.041	0.039	0.042	0.04
	RPM	955	928	796	597	531	477	506	446	398	371
	FEED	74	66	67	64	64	69	71	50	48	42
8-9	Vc	15	15	20	15	15	15	15	15	15	15
	fz	0.027	0.033	0.038	0.044	0.048	0.053	0.04	0.038	0.035	0.035
	RPM	477	398	455	298	265	239	217	191	171	159
	FEED	39	39	52	39	38	38	35	29	24	22
10	Vc	30	35	35	30	30	30	35	35	35	35
	fz	0.032	0.041	0.04	0.053	0.058	0.063	0.048	0.047	0.047	0.046
	RPM	955	928	796	597	531	477	506	446	398	371
	FEED	92	114	95	95	92	90	97	84	75	68
11.1	Vc	15	15	20	15	15	15	15	15	15	15
	fz	0.027	0.033	0.038	0.044	0.048	0.053	0.04	0.038	0.035	0.035
	RPM	477	398	455	298	265	239	217	191	171	159
	FEED	39	39	52	39	38	38	35	29	24	22

EQ461, EQ462, EQ463 SERIES

MULTI FLUTE TiAlN COATED - SIDE CUTTING

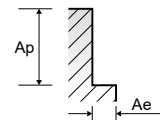

VDI 3323	Parameter	Diameter (Ø)									
		10.0	12.0	14.0	16.0	18.0	20.0	22.0	25.0	28.0	30.0
1-2	Vc	45	50	50	40	45	45	50	50	50	45
	fz	0.032	0.041	0.04	0.054	0.058	0.064	0.048	0.048	0.047	0.046
	RPM	1432	1326	1137	796	796	716	723	637	568	477
	FEED	138	163	136	129	138	138	139	122	107	88
3-4	Vc	40	35	35	35	35	40	40	40	35	35
	fz	0.026	0.034	0.04	0.043	0.048	0.048	0.04	0.038	0.042	0.042
	RPM	1273	928	796	696	619	637	579	509	398	371
	FEED	99	95	95	90	89	92	93	77	67	62
5	Vc	20	25	25	20	20	20	25	20	20	25
	fz	0.026	0.034	0.039	0.044	0.047	0.052	0.039	0.036	0.035	0.035
	RPM	637	663	568	398	354	318	362	255	227	265
	FEED	50	68	67	53	50	50	56	37	32	37
6	Vc	45	50	50	40	45	45	50	50	50	45
	fz	0.032	0.041	0.04	0.054	0.058	0.064	0.048	0.048	0.047	0.046
	RPM	1432	1326	1137	796	796	716	723	637	568	477
	FEED	138	163	136	129	138	138	139	122	107	88
7	Vc	40	35	35	35	35	40	40	40	35	35
	fz	0.026	0.034	0.04	0.043	0.048	0.048	0.04	0.038	0.042	0.042
	RPM	1273	928	796	696	619	637	579	509	398	371
	FEED	99	95	95	90	89	92	93	77	67	62
8-9	Vc	20	25	25	20	20	20	25	20	20	25
	fz	0.026	0.034	0.039	0.044	0.047	0.052	0.039	0.036	0.035	0.035
	RPM	637	663	568	398	354	318	362	255	227	265
	FEED	50	68	67	53	50	50	56	37	32	37
10	Vc	45	50	50	40	45	45	50	50	50	45
	fz	0.032	0.041	0.04	0.054	0.058	0.064	0.048	0.048	0.047	0.046
	RPM	1432	1326	1137	796	796	716	723	637	568	477
	FEED	138	163	136	129	138	138	139	122	107	88
11.1	Vc	20	25	25	20	20	20	25	20	20	25
	fz	0.026	0.034	0.039	0.044	0.047	0.052	0.039	0.036	0.035	0.035
	RPM	637	663	568	398	354	318	362	255	227	265
	FEED	50	68	67	53	50	50	56	37	32	37

CBN END MILLS

i-Xmill END MILLS

i-SMART MODULAR END MILLS

X5070 END MILLS

4G MILL END MILLS

X-POWER PRO END MILLS

TitaNox-POWER END MILLS

JET-POWER END MILLS

V7 PLUS END MILLS

ALU-POWER HPC END MILLS

ALU-POWER END MILLS

D-POWER GRAPHITE END MILLS

D-POWER CFRP END MILLS

ROUTERS

CRX S END MILLS

K-2 END MILLS

ONLY ONE COATED PM60 END MILLS

TANK-POWER END MILLS

GENERAL HSS END MILLS

MILLING CUTTERS

TECHNICAL DATA

E2761, E2753, E2762, E2751, E2764, E2752, E2765, E2778, E2777 SERIES

Vc = m/min.
fz = mm/tooth
RPM = rev./min.
FEED = mm/min.

MULTI FLUTE ROUGHING - SIDE CUTTING

ISO	VDI 3323	Material Description	Ae	Ap	Parameter	Diameter (Ø)					
						6.0	8.0	10.0	12.0	14.0	16.0
P	1	Non-alloy steel	0.5D	1.5D	Vc	35	35	35	35	35	35
					fz	0.015	0.025	0.034	0.05	0.056	0.064
					RPM	1857	1393	1114	928	796	696
	2		0.5D	1.5D	Vc	30	30	30	30	30	30
					fz	0.013	0.023	0.033	0.044	0.05	0.063
					RPM	1592	1194	955	796	682	597
	3-4		0.5D	1.5D	Vc	25	25	25	25	25	25
					fz	0.015	0.024	0.034	0.044	0.049	0.061
					RPM	1326	995	796	663	568	497
	5		0.5D	1.5D	Vc	15	15	15	15	15	15
					fz	0.013	0.021	0.033	0.044	0.05	0.063
RPM		796			597	477	398	341	298		
6	0.5D	1.5D	Vc	30	30	30	30	30	30		
			fz	0.013	0.023	0.033	0.044	0.05	0.063		
			RPM	1592	1194	955	796	682	597		
7	0.5D	1.5D	Vc	25	25	25	25	25	25		
			fz	0.015	0.024	0.034	0.044	0.049	0.061		
			RPM	1326	995	796	663	568	497		
8-9	0.5D	1.5D	Vc	15	15	15	15	15	15		
			fz	0.013	0.021	0.033	0.044	0.05	0.063		
			RPM	796	597	477	398	341	298		
10	0.5D	1.5D	Vc	30	30	30	30	30	30		
			fz	0.013	0.023	0.033	0.044	0.05	0.063		
			RPM	1592	1194	955	796	682	597		
11.1	0.5D	1.5D	Vc	15	15	15	15	15	15		
			fz	0.013	0.021	0.033	0.044	0.05	0.063		
			RPM	796	597	477	398	341	298		
21-22	0.5D	1.5D	Vc	85	80	80	75	80	80		
			fz	0.015	0.025	0.035	0.05	0.058	0.07		
			RPM	4509	3183	2546	1989	1819	1592		
23-24	0.5D	1.5D	Vc	55	52	52	49	52	52		
			fz	0.015	0.025	0.035	0.05	0.058	0.07		
			RPM	2918	2069	1655	1300	1182	1035		
					FEED	131	155	232	260	274	290

※ The FEED, in long & extra long types, should be reduced by around 50%

▶ NEXT PAGE

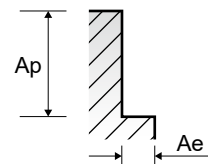

Vc = m/min.
fz = mm/tooth
RPM = rev./min.
FEED = mm/min.

E2761, E2753, E2762, E2751, E2764, E2752, E2765, E2778, E2777 SERIES

MULTI FLUTE ROUGHING - SIDE CUTTING

VDI 3323	Parameter	Diameter (Ø)									
		18.0	20.0	22.0	25.0	28.0	30.0	32.0	36.0	40.0	50.0
1	Vc	35	35	35	35	35	35	35	35	35	35
	fz	0.071	0.08	0.088	0.098	0.088	0.1	0.1	0.113	0.119	0.152
	RPM	619	557	506	446	398	371	348	309	279	223
	FEED	176	178	223	218	210	223	209	210	199	203
2	Vc	30	30	30	30	30	30	30	30	30	30
	fz	0.07	0.078	0.076	0.085	0.076	0.086	0.095	0.107	0.114	0.157
	RPM	531	477	434	382	341	318	298	265	239	191
	FEED	149	149	165	162	156	164	170	170	163	180
3-4	Vc	25	25	25	25	25	25	20	25	25	25
	fz	0.069	0.069	0.08	0.09	0.077	0.087	0.098	0.108	0.111	0.146
	RPM	442	398	362	318	284	265	199	221	199	159
	FEED	122	110	145	143	131	138	117	143	132	139
5	Vc	15	15	15	15	15	15	15	15	15	15
	fz	0.07	0.08	0.077	0.094	0.089	0.089	0.101	0.118	0.121	0.148
	RPM	265	239	217	191	171	159	149	133	119	95
	FEED	74	76	84	90	91	85	90	94	87	85
6	Vc	30	30	30	30	30	30	30	30	30	30
	fz	0.07	0.078	0.076	0.085	0.076	0.086	0.095	0.107	0.114	0.157
	RPM	531	477	434	382	341	318	298	265	239	191
	FEED	149	149	165	162	156	164	170	170	163	180
7	Vc	25	25	25	25	25	25	20	25	25	25
	fz	0.069	0.069	0.08	0.09	0.077	0.087	0.098	0.108	0.111	0.146
	RPM	442	398	362	318	284	265	199	221	199	159
	FEED	122	110	145	143	131	138	117	143	132	139
8-9	Vc	15	15	15	15	15	15	15	15	15	15
	fz	0.07	0.08	0.077	0.094	0.089	0.089	0.101	0.118	0.121	0.148
	RPM	265	239	217	191	171	159	149	133	119	95
	FEED	74	76	84	90	91	85	90	94	87	85
10	Vc	30	30	30	30	30	30	30	30	30	30
	fz	0.07	0.078	0.076	0.085	0.076	0.086	0.095	0.107	0.114	0.157
	RPM	531	477	434	382	341	318	298	265	239	191
	FEED	149	149	165	162	156	164	170	170	163	180
11.1	Vc	15	15	15	15	15	15	15	15	15	15
	fz	0.07	0.08	0.077	0.094	0.089	0.089	0.101	0.118	0.121	0.148
	RPM	265	239	217	191	171	159	149	133	119	95
	FEED	74	76	84	90	91	85	90	94	87	85
21 - 22	Vc	80	75	75	80	80	85	80	80	80	80
	fz	0.084	0.104	0.085	0.09	0.094	0.098	0.104	0.112	0.119	0.123
	RPM	1415	1194	1085	1019	909	902	796	707	637	509
	FEED	475	497	461	458	513	530	497	475	455	376
23 - 24	Vc	52	49	49	52	52	55	52	52	52	52
	fz	0.084	0.104	0.085	0.09	0.094	0.098	0.104	0.112	0.119	0.123
	RPM	920	780	709	662	591	584	517	460	414	331
	FEED	309	324	301	298	333	343	323	309	295	244

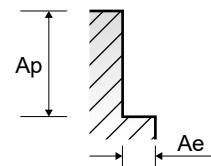

EQ761, EQ753, EQ762, EQ751 EQ764, EQ752 EQ765, EQ778, EQ777 SERIES

Vc = m/min.
fz = mm/tooth
RPM = rev./min.
FEED = mm/min.

MULTI FLUTE ROUGHING TiAIN COATED - SIDE CUTTING

ISO	VDI 3323	Material Description	Ae	Ap	Parameter	Diameter (Ø)					
						6.0	8.0	10.0	12.0	14.0	16.0
P	1	Non-alloy steel	0.5D	1.5D	Vc	45	50	50	45	50	50
					fz	0.015	0.025	0.034	0.05	0.057	0.063
					RPM	2387	1989	1592	1194	1137	995
	2		0.5D	1.5D	Vc	40	40	40	40	45	40
					fz	0.013	0.023	0.034	0.044	0.049	0.061
					RPM	2122	1592	1273	1061	1023	796
	3-4		0.5D	1.5D	Vc	30	30	35	35	35	35
					fz	0.015	0.024	0.035	0.043	0.048	0.06
					RPM	1592	1194	1114	928	796	696
	5		0.5D	1.5D	Vc	20	20	20	20	20	20
					fz	0.012	0.021	0.033	0.045	0.05	0.063
RPM		1061			796	637	531	455	398		
6	0.5D	1.5D	Vc	40	40	40	40	45	40		
			fz	0.013	0.023	0.034	0.044	0.049	0.061		
			RPM	2122	1592	1273	1061	1023	796		
7	0.5D	1.5D	Vc	30	30	35	35	35	35		
			fz	0.015	0.024	0.035	0.043	0.048	0.06		
			RPM	1592	1194	1114	928	796	696		
8-9	0.5D	1.5D	Vc	20	20	20	20	20	20		
			fz	0.012	0.021	0.033	0.045	0.05	0.063		
			RPM	1061	796	637	531	455	398		
10	0.5D	1.5D	Vc	40	40	40	40	45	40		
			fz	0.013	0.023	0.034	0.044	0.049	0.061		
			RPM	2122	1592	1273	1061	1023	796		
11.1	0.5D	1.5D	Vc	20	20	20	20	20	20		
			fz	0.012	0.021	0.033	0.045	0.05	0.063		
			RPM	1061	796	637	531	455	398		
N	21-22	Aluminum-wrought alloy	0.5D	1.5D	Vc	120	110	110	105	110	115
					fz	0.015	0.025	0.035	0.05	0.059	0.07
					RPM	6366	4377	3501	2785	2501	2288
					FEED	286	328	490	557	590	641
N	23-24	Aluminum-cast, alloyed	0.5D	1.5D	Vc	78	72	72	68	72	75
					fz	0.015	0.025	0.035	0.05	0.059	0.07
					RPM	4138	2865	2292	1804	1637	1492
					FEED	186	215	321	361	386	418

※ The FEED, in long & extra long types, should be reduced by around 50%

▶ NEXT PAGE

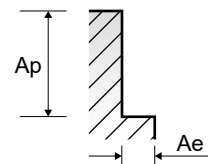

EQ761, EQ753, EQ762, EQ751 EQ764, EQ752 EQ765, EQ778, EQ777 SERIES

Vc = m/min.
fz = mm/tooth
RPM = rev./min.
FEED = mm/min.

MULTI FLUTE ROUGHING TiAIN COATED - SIDE CUTTING

VDI 3323	Parameter	Diameter (Ø)									
		18.0	20.0	22.0	25.0	28.0	30.0	32.0	36.0	40.0	50.0
1	Vc	50	50	50	50	50	45	50	50	50	45
	fz	0.069	0.078	0.089	0.095	0.089	0.098	0.098	0.109	0.117	0.156
	RPM	884	796	723	637	568	477	497	442	398	286
	FEED	244	248	322	302	304	281	292	289	279	268
2	Vc	40	40	45	45	45	40	40	40	40	40
	fz	0.07	0.075	0.074	0.087	0.075	0.083	0.094	0.107	0.117	0.16
	RPM	707	637	651	573	512	424	398	354	318	255
	FEED	198	191	241	249	230	211	224	227	223	244
3-4	Vc	30	35	35	35	35	35	30	35	30	35
	fz	0.07	0.07	0.078	0.087	0.075	0.086	0.1	0.1	0.113	0.148
	RPM	531	557	506	446	398	371	298	309	239	223
	FEED	149	156	197	194	179	192	179	186	162	198
5	Vc	20	20	20	20	20	20	20	20	15	20
	fz	0.071	0.083	0.08	0.096	0.091	0.091	0.1	0.118	0.141	0.153
	RPM	354	318	289	255	227	212	199	177	119	127
	FEED	100	106	116	122	124	116	119	125	101	117
6	Vc	40	40	45	45	45	40	40	40	40	40
	fz	0.07	0.075	0.074	0.087	0.075	0.083	0.094	0.107	0.117	0.16
	RPM	707	637	651	573	512	424	398	354	318	255
	FEED	198	191	241	249	230	211	224	227	223	244
7	Vc	30	35	35	35	35	35	30	35	30	35
	fz	0.07	0.07	0.078	0.087	0.075	0.086	0.1	0.1	0.113	0.148
	RPM	531	557	506	446	398	371	298	309	239	223
	FEED	149	156	197	194	179	192	179	186	162	198
8-9	Vc	20	20	20	20	20	20	20	20	15	20
	fz	0.071	0.083	0.08	0.096	0.091	0.091	0.1	0.118	0.141	0.153
	RPM	354	318	289	255	227	212	199	177	119	127
	FEED	100	106	116	122	124	116	119	125	101	117
10	Vc	40	40	45	45	45	40	40	40	40	40
	fz	0.07	0.075	0.074	0.087	0.075	0.083	0.094	0.107	0.117	0.16
	RPM	707	637	651	573	512	424	398	354	318	255
	FEED	198	191	241	249	230	211	224	227	223	244
11.1	Vc	20	20	20	20	20	20	20	20	15	20
	fz	0.071	0.083	0.08	0.096	0.091	0.091	0.1	0.118	0.141	0.153
	RPM	354	318	289	255	227	212	199	177	119	127
	FEED	100	106	116	122	124	116	119	125	101	117
21 - 22	Vc	110	105	105	110	110	120	110	115	115	110
	fz	0.085	0.103	0.085	0.09	0.095	0.099	0.106	0.11	0.117	0.124
	RPM	1945	1671	1519	1401	1251	1273	1094	1017	915	700
	FEED	661	689	646	630	713	756	696	671	642	521
23 - 24	Vc	72	68	68	72	72	78	72	75	75	72
	fz	0.085	0.103	0.085	0.09	0.095	0.099	0.106	0.11	0.117	0.124
	RPM	1273	1082	984	917	819	828	716	663	597	458
	FEED	433	446	418	413	467	492	456	438	419	341

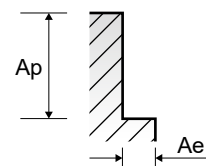

CBN END MILLS

i-Xmill END MILLS

i-SMART MODULAR END MILLS

X5070 END MILLS

4G MILL END MILLS

X-POWER PRO END MILLS

TitaNox-POWER END MILLS

JET-POWER END MILLS

V7 PLUS END MILLS

ALU-POWER HPC END MILLS

ALU-POWER END MILLS

D-POWER GRAPHITE END MILLS

D-POWER CFRP END MILLS

ROUTERS

CRX S END MILLS

K-2 END MILLS

ONLY ONE COATED PM60 END MILLS

TANK-POWER END MILLS

GENERAL HSS END MILLS

MILLING CUTTERS

TECHNICAL DATA



E2606, E2757 SERIES

MULTI FLUTE BALL NOSE ROUGHING - SIDE CUTTING

ISO	VDI 3323	Material Description	Ae	Ap	Parameter	Diameter (Ø)								
						8.0	10.0	12.0	16.0	20.0	25.0	32.0	40.0	
P	1	Non-alloy steel	0.5D	1.5D	Vc	35	35	35	35	35	35	35	35	35
					fz	0.025	0.045	0.05	0.064	0.08	0.122	0.15	0.179	
					RPM	1393	1114	928	696	557	446	348	279	
	2		Vc	30	30	30	30	30	30	30	30			
			fz	0.023	0.044	0.044	0.063	0.078	0.106	0.143	0.17			
			RPM	1194	955	796	597	477	382	298	239			
	3-4		Vc	25	25	25	25	25	25	25	25			
			fz	0.024	0.046	0.044	0.061	0.069	0.113	0.148	0.167			
			RPM	995	796	663	497	398	318	199	199			
	5		Vc	15	15	15	15	15	15	15	15			
			fz	0.021	0.044	0.044	0.063	0.08	0.118	0.152	0.182			
RPM		597	477	398	298	239	191	149	119					
6	Vc	30	30	30	30	30	30	30	30					
	fz	0.023	0.044	0.044	0.063	0.078	0.106	0.143	0.17					
	RPM	1194	955	796	597	477	382	298	239					
7	Vc	25	25	25	25	25	25	25	25					
	fz	0.024	0.046	0.044	0.061	0.069	0.113	0.148	0.167					
	RPM	995	796	663	497	398	318	199	199					
8-9	Vc	15	15	15	15	15	15	15	15					
	fz	0.021	0.044	0.044	0.063	0.08	0.118	0.152	0.182					
	RPM	597	477	398	298	239	191	149	119					
10	Vc	30	30	30	30	30	30	30	30					
	fz	0.023	0.044	0.044	0.063	0.078	0.106	0.143	0.17					
	RPM	1194	955	796	597	477	382	298	239					
11.1	Vc	15	15	15	15	15	15	15	15					
	fz	0.021	0.044	0.044	0.063	0.08	0.118	0.152	0.182					
	RPM	597	477	398	298	239	191	149	119					
N	21-22	Aluminum-wrought alloy	0.5D	1.5D	Vc	80	80	75	80	75	80	80	80	
					fz	0.025	0.033	0.05	0.07	0.104	0.113	0.156	0.179	
					RPM	3183	2546	1989	1592	1194	1019	796	637	
					FEED	239	252	398	446	497	460	497	456	
23-24	Aluminum-cast, alloyed	0.5D	1.5D	Vc	52	52	49	52	49	52	52	52		
				fz	0.025	0.033	0.05	0.07	0.104	0.113	0.156	0.179		
				RPM	2069	1655	1300	1035	780	662	517	414		
				FEED	155	164	260	290	324	299	323	296		

※ The FEED, in long & extra long types, should be reduced by around 50%

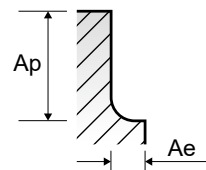

EQ606, EQ757 SERIES MULTI FLUTE BALL NOSE ROUGHING TiAlN COATED - **SIDE CUTTING**

ISO	VDI 3323	Material Description	Ae	Ap	Parameter	Diameter (Ø)								
						8.0	10.0	12.0	16.0	20.0	25.0	32.0	40.0	
P	1	Non-alloy steel	0.5D	1.5D	Vc	50	50	50	50	50	50	50	50	50
					fz	0.026	0.045	0.05	0.064	0.079	0.123	0.151	0.179	
					RPM	1989	1592	1326	995	796	637	497	398	
	2		0.5D	1.5D	Vc	40	40	40	40	40	45	40	40	40
					fz	0.023	0.045	0.044	0.062	0.077	0.107	0.144	0.169	
					RPM	1592	1273	1061	796	637	573	398	318	
	3-4		0.5D	1.5D	Vc	30	35	35	30	35	35	30	30	30
					fz	0.024	0.046	0.044	0.062	0.069	0.111	0.145	0.17	
					RPM	1194	1114	928	597	557	446	298	239	
	5		0.5D	1.5D	Vc	20	20	20	20	20	20	20	20	20
					fz	0.021	0.045	0.045	0.064	0.081	0.12	0.15	0.172	
RPM		796			637	531	398	318	255	199	159			
6	0.5D	1.5D	Vc	40	40	40	40	40	45	40	40	40		
			fz	0.023	0.045	0.044	0.062	0.077	0.107	0.144	0.169			
			RPM	1592	1273	1061	796	637	573	398	318			
7	0.5D	1.5D	Vc	30	35	35	30	35	35	30	30	30		
			fz	0.024	0.046	0.044	0.062	0.069	0.111	0.145	0.17			
			RPM	1194	1114	928	597	557	446	298	239			
8-9	0.5D	1.5D	Vc	20	20	20	20	20	20	20	20	20		
			fz	0.021	0.045	0.045	0.064	0.081	0.12	0.15	0.172			
			RPM	796	637	531	398	318	255	199	159			
10	0.5D	1.5D	Vc	40	40	40	40	40	45	40	40	40		
			fz	0.023	0.045	0.044	0.062	0.077	0.107	0.144	0.169			
			RPM	1592	1273	1061	796	637	573	398	318			
11.1	0.5D	1.5D	Vc	20	20	20	20	20	20	20	20	20		
			fz	0.021	0.045	0.045	0.064	0.081	0.12	0.15	0.172			
			RPM	796	637	531	398	318	255	199	159			
21-22	0.5D	1.5D	Vc	110	110	105	115	105	110	115	110	110		
			fz	0.025	0.033	0.05	0.07	0.104	0.113	0.156	0.179			
			RPM	4377	3501	2785	2288	1671	1401	1144	875			
23-24	0.5D	1.5D	Vc	72	72	68	75	68	72	75	72	72		
			fz	0.025	0.033	0.05	0.07	0.104	0.113	0.156	0.179			
			RPM	2865	2292	1804	1492	1082	917	746	573			
						FEED	215	227	361	418	450	414	466	410

※ The FEED, in long & extra long types, should be reduced by around 50%

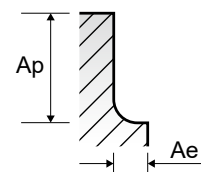

CBN END MILLS

i-Xmill END MILLS

i-SMART MODULAR END MILLS

X5070 END MILLS

4G MILL END MILLS

X-POWER PRO END MILLS

TitaNox-POWER END MILLS

JET-POWER END MILLS

V7 PLUS END MILLS

ALU-POWER HPC END MILLS

ALU-POWER END MILLS

D-POWER GRAPHITE END MILLS

D-POWER CFRP END MILLS

ROUTERS

CRX S END MILLS

K-2 END MILLS

ONLY ONE COATED PM60 END MILLS

TANK-POWER END MILLS

GENERAL HSS END MILLS

MILLING CUTTERS

TECHNICAL DATA

E2524 SERIES

MULTI FLUTE ROUGHING - SIDE CUTTING

ISO	VDI 3323	Material Description	Ae	Ap	Parameter	Diameter (Ø)								
						6.0	8.0	10.0	12.0	14.0	16.0	18.0	20.0	
P	1	Non-alloy steel	0.5D	1.5D	Vc	35	35	35	35	35	35	35	35	35
					fz	0.015	0.019	0.034	0.05	0.056	0.064	0.071	0.08	
					RPM	1857	1393	1114	928	796	696	619	557	
	2		0.5D	1.5D	FEED	84	106	152	186	178	178	176	178	
					Vc	30	30	30	30	30	30	30	30	
					fz	0.013	0.017	0.033	0.044	0.05	0.063	0.07	0.078	
	3-4		0.5D	1.5D	RPM	1592	1194	955	796	682	597	531	477	
					FEED	62	81	126	140	136	150	149	149	
					Vc	25	25	25	25	25	25	25	25	
	5		0.5D	1.5D	fz	0.015	0.018	0.034	0.044	0.049	0.061	0.069	0.069	
					RPM	1326	995	796	663	568	497	442	398	
FEED		60			72	108	117	111	121	122	110			
6	0.5D	1.5D	Vc	15	15	15	15	15	15	15	15			
			fz	0.013	0.016	0.033	0.044	0.05	0.063	0.07	0.08			
			RPM	796	597	477	398	341	298	265	239			
7	0.5D	1.5D	FEED	31	38	63	70	68	75	74	76			
			Vc	30	30	30	30	30	30	30	30			
			fz	0.013	0.017	0.033	0.044	0.05	0.063	0.07	0.078			
8-9	0.5D	1.5D	RPM	1592	1194	955	796	682	597	531	477			
			FEED	62	81	126	140	136	150	149	149			
			Vc	25	25	25	25	25	25	25	25			
10	0.5D	1.5D	fz	0.015	0.018	0.034	0.044	0.049	0.061	0.069	0.069			
			RPM	1326	995	796	663	568	497	442	398			
			FEED	60	72	108	117	111	121	122	110			
11.1	0.5D	1.5D	Vc	15	15	15	15	15	15	15	15			
			fz	0.013	0.016	0.033	0.044	0.05	0.063	0.07	0.08			
			RPM	796	597	477	398	341	298	265	239			
21-22	0.5D	1.5D	FEED	31	38	63	70	68	75	74	76			
			Vc	30	30	30	30	30	30	30	30			
			fz	0.013	0.017	0.033	0.044	0.05	0.063	0.07	0.078			
23-24	0.5D	1.5D	RPM	1592	1194	955	796	682	597	531	477			
			FEED	62	81	126	140	136	150	149	149			
			Vc	85	80	80	75	80	80	80	75			
N	0.5D	1.5D	fz	0.015	0.019	0.035	0.05	0.058	0.07	0.084	0.104			
			RPM	4509	3183	2546	1989	1819	1592	1415	1194			
			FEED	62	81	126	140	136	150	149	149			
D-POWER GRAPHITE END MILLS	0.5D	1.5D	Vc	55	52	52	49	52	52	52	52			
			fz	0.015	0.019	0.035	0.05	0.058	0.07	0.084	0.104			
			RPM	2918	2069	1655	1300	1182	1035	920	780			
D-POWER CFRP END MILLS	0.5D	1.5D	FEED	62	81	126	140	136	150	149	149			

※ The FEED, in long & extra long types, should be reduced by around 50%

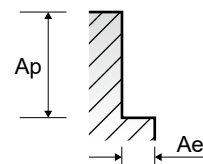

EQ524 SERIES

MULTI FLUTE ROUGHING TiAIN COATED - SIDE CUTTING

ISO	VDI 3323	Material Description	Ae	Ap	Parameter	Diameter (Ø)								
						6.0	8.0	10.0	12.0	14.0	16.0	18.0	20.0	
P	1	Non-alloy steel	0.5D	1.5D	Vc	45	50	50	45	50	50	50	50	50
					fz	0.015	0.019	0.034	0.05	0.057	0.063	0.069	0.078	
					RPM	2387	1989	1592	1194	1137	995	884	796	
					FEED	107	151	216	239	259	251	244	248	
	2		0.5D	1.5D	Vc	40	40	40	40	45	40	40	40	40
					fz	0.013	0.017	0.034	0.044	0.049	0.061	0.07	0.075	
					RPM	2122	1592	1273	1061	1023	796	707	637	
					FEED	83	108	173	187	201	194	198	191	
	3-4		0.5D	1.5D	Vc	30	30	35	35	35	35	30	35	
					fz	0.015	0.018	0.035	0.043	0.048	0.06	0.07	0.07	
					RPM	1592	1194	1114	928	796	696	531	557	
FEED		72			86	156	160	153	167	149	156			
5	0.5D	1.5D	Vc	20	20	20	20	20	20	20	20			
			fz	0.012	0.016	0.033	0.045	0.05	0.063	0.071	0.083			
			RPM	1061	796	637	531	455	398	354	318			
			FEED	38	51	84	95	91	100	100	106			
6	0.5D	1.5D	Vc	40	40	40	40	45	40	40	40			
			fz	0.013	0.017	0.034	0.044	0.049	0.061	0.07	0.075			
			RPM	2122	1592	1273	1061	1023	796	707	637			
			FEED	83	108	173	187	201	194	198	191			
7	0.5D	1.5D	Vc	30	30	35	35	35	35	30	35			
			fz	0.015	0.018	0.035	0.043	0.048	0.06	0.07	0.07			
			RPM	1592	1194	1114	928	796	696	531	557			
			FEED	72	86	156	160	153	167	149	156			
8-9	0.5D	1.5D	Vc	20	20	20	20	20	20	20	20			
			fz	0.012	0.016	0.033	0.045	0.05	0.063	0.071	0.083			
			RPM	1061	796	637	531	455	398	354	318			
			FEED	38	51	84	95	91	100	100	106			
10	0.5D	1.5D	Vc	40	40	40	40	45	40	40	40			
			fz	0.013	0.017	0.034	0.044	0.049	0.061	0.07	0.075			
			RPM	2122	1592	1273	1061	1023	796	707	637			
			FEED	83	108	173	187	201	194	198	191			
11.1	0.5D	1.5D	Vc	20	20	20	20	20	20	20	20			
			fz	0.012	0.016	0.033	0.045	0.05	0.063	0.071	0.083			
			RPM	1061	796	637	531	455	398	354	318			
			FEED	38	51	84	95	91	100	100	106			
N	21-22	Aluminum-wrought alloy	0.5D	1.5D	Vc	120	110	110	105	110	115	110	105	
					fz	0.015	0.018	0.035	0.05	0.059	0.07	0.085	0.103	
					RPM	6366	4377	3501	2785	2501	2288	1945	1671	
					FEED	286	315	490	557	590	641	661	689	
23-24	Aluminum-cast, alloyed	0.5D	1.5D	Vc	78	72	72	68	72	75	72	68		
				fz	0.015	0.018	0.035	0.05	0.059	0.07	0.085	0.103		
				RPM	4138	2865	2292	1804	1637	1492	1273	1082		
				FEED	186	206	321	361	386	418	433	446		

※ The FEED, in long & extra long types, should be reduced by around 50%

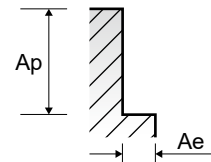



RECOMMENDED CUTTING CONDITIONS
EMPFOHLENE SCHNEIDPARAMETER

E2595, E2596 SERIES

MULTI FLUTE - SIDE CUTTING

Vc = m/min.
fz = mm/tooth
RPM = rev./min.
FEED = mm/min.

ISO	VDI 3323	Material Description	Ae	Ap	Parameter	Diameter (Ø)						
						2.0	3.0	4.0	5.0	6.0	8.0	10.0
P	1	Non-alloy steel	0.1D	1.5D	Vc	35	35	35	35	35	35	35
					fz	0.004	0.008	0.013	0.02	0.025	0.036	0.045
					RPM	5570	3714	2785	2228	1857	1393	1114
	2		Vc	30	30	30	30	30	30	30		
			fz	0.003	0.006	0.011	0.017	0.023	0.036	0.044		
			RPM	4775	3183	2387	1910	1592	1194	955		
	3-4		Vc	25	25	25	25	25	25	25		
			fz	0.003	0.006	0.009	0.014	0.019	0.029	0.038		
			RPM	3979	2653	1989	1592	1326	995	796		
	5		Vc	15	15	15	15	15	15	15		
fz		0.002	0.005	0.01	0.014	0.019	0.029	0.036				
RPM		2387	1592	1194	955	796	597	477				
6	Vc	30	30	30	30	30	30	30				
	fz	0.003	0.006	0.011	0.017	0.023	0.036	0.044				
	RPM	4775	3183	2387	1910	1592	1194	955				
7	Vc	25	25	25	25	25	25	25				
	fz	0.003	0.006	0.009	0.014	0.019	0.029	0.038				
	RPM	3979	2653	1989	1592	1326	995	796				
8-9	Vc	15	15	15	15	15	15	15				
	fz	0.002	0.005	0.01	0.014	0.019	0.029	0.036				
	RPM	2387	1592	1194	955	796	597	477				
10	Vc	30	30	30	30	30	30	30				
	fz	0.003	0.006	0.011	0.017	0.023	0.036	0.044				
	RPM	4775	3183	2387	1910	1592	1194	955				
11.1	Vc	15	15	15	15	15	15	15				
	fz	0.002	0.005	0.01	0.014	0.019	0.029	0.036				
	RPM	2387	1592	1194	955	796	597	477				
N	21-22	Aluminum-wrought alloy	0.1D	1.5D	Vc	75	105	100	100	105	100	95
					fz	0.005	0.009	0.014	0.019	0.021	0.036	0.048
23-24	Aluminum-cast, alloyed	0.1D	1.5D	Vc	49	68	65	65	68	65	62	
				fz	0.005	0.009	0.014	0.019	0.021	0.036	0.048	

※ The FEED, in long & extra long types, should be reduced by around 50%

▶ NEXT PAGE

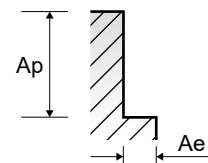

E2595, E2596 SERIES

MULTI FLUTE - SIDE CUTTING

Vc = m/min.
fz = mm/tooth
RPM = rev./min.
FEED = mm/min.

VDI 3323	Parameter	Diameter (Ø)											
		12.0	14.0	16.0	18.0	20.0	22.0	25.0	28.0	30.0	32.0	36.0	40.0
1	Vc	35	35	35	35	35	35	35	35	35	35	35	35
	fz	0.061	0.069	0.079	0.079	0.089	0.1	0.1	0.067	0.067	0.067	0.065	0.071
	RPM	928	796	696	619	557	506	446	398	371	348	309	279
2	FEED	227	220	220	196	198	203	178	160	149	140	121	119
	Vc	30	30	30	30	30	30	30	30	30	30	30	30
	fz	0.056	0.057	0.071	0.08	0.089	0.089	0.091	0.06	0.059	0.06	0.06	0.068
3-4	RPM	796	682	597	531	477	434	382	341	318	298	265	239
	FEED	178	156	170	170	170	155	139	123	113	107	95	97
	Vc	25	25	25	25	25	25	25	25	25	20	25	25
5	fz	0.048	0.054	0.058	0.066	0.066	0.075	0.073	0.048	0.05	0.049	0.05	0.056
	RPM	663	568	497	442	398	362	318	284	265	199	221	199
	FEED	127	123	115	117	105	109	93	82	80	58	66	67
6	Vc	15	15	15	15	15	15	15	15	15	15	15	15
	fz	0.047	0.054	0.058	0.065	0.074	0.074	0.069	0.047	0.047	0.054	0.049	0.053
	RPM	398	341	298	265	239	217	191	171	159	149	133	119
7	FEED	75	74	69	69	71	64	53	48	45	48	39	38
	Vc	30	30	30	30	30	30	30	30	30	30	30	30
	fz	0.056	0.057	0.071	0.08	0.089	0.089	0.091	0.06	0.059	0.06	0.06	0.068
8-9	RPM	796	682	597	531	477	434	382	341	318	298	265	239
	FEED	178	156	170	170	170	155	139	123	113	107	95	97
	Vc	25	25	25	25	25	25	25	25	25	20	25	25
10	fz	0.048	0.054	0.058	0.066	0.066	0.075	0.073	0.048	0.05	0.049	0.05	0.056
	RPM	663	568	497	442	398	362	318	284	265	199	221	199
	FEED	127	123	115	117	105	109	93	82	80	58	66	67
11.1	Vc	15	15	15	15	15	15	15	15	15	15	15	15
	fz	0.047	0.054	0.058	0.065	0.074	0.074	0.069	0.047	0.047	0.054	0.049	0.053
	RPM	398	341	298	265	239	217	191	171	159	149	133	119
21	FEED	75	74	69	69	71	64	53	48	45	48	39	38
	Vc	95	95	100	100	100	95	95	95	105	100	100	100
	fz	0.057	0.06	0.066	0.074	0.075	0.08	0.088	0.061	0.061	0.06	0.061	0.06
22	RPM	2520	2160	1989	1768	1592	1375	1210	1080	1114	995	884	796
	FEED	575	518	525	523	477	440	426	395	408	358	324	286
	Vc	62	62	65	65	65	62	62	62	62	68	65	65
23	fz	0.057	0.06	0.066	0.074	0.075	0.08	0.088	0.061	0.061	0.06	0.061	0.06
	RPM	1645	1410	1293	1149	1035	897	789	705	722	647	575	517
	FEED	375	338	341	340	310	287	278	258	264	233	210	186

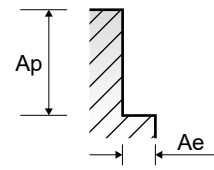



RECOMMENDED CUTTING CONDITIONS
EMPFOHLENE SCHNEIDPARAMETER

EQ595, EQ596 SERIES

MULTI FLUTE TiAlN COATED - RED CUTTING

Vc = m/min.
fz = mm/tooth
RPM = rev./min.
FEED = mm/min.

ISO	VDI 3323	Material Description	Ae	Ap	Parameter	Diameter (Ø)						
						2.0	3.0	4.0	5.0	6.0	8.0	10.0
P	1	Non-alloy steel	0.1D	1.5D	Vc	50	45	50	50	45	50	50
					fz	0.004	0.008	0.013	0.02	0.025	0.036	0.045
					RPM	7958	4775	3979	3183	2387	1989	1592
	2		Vc	40	40	40	40	40	40	40		
			fz	0.003	0.006	0.011	0.018	0.023	0.036	0.045		
			RPM	6366	4244	3183	2546	2122	1592	1273		
	3-4		Vc	35	35	30	35	30	30	35		
			fz	0.003	0.006	0.009	0.014	0.018	0.029	0.039		
			RPM	5570	3714	2387	2228	1592	1194	1114		
	5		Vc	20	20	20	20	20	20	20		
fz		0.002	0.004	0.01	0.014	0.019	0.028	0.035				
RPM		3183	2122	1592	1273	1061	796	637				
6	Vc	40	40	40	40	40	40	40				
	fz	0.003	0.006	0.011	0.018	0.023	0.036	0.045				
	RPM	6366	4244	3183	2546	2122	1592	1273				
7	Vc	35	35	30	35	30	30	35				
	fz	0.003	0.006	0.009	0.014	0.018	0.029	0.039				
	RPM	5570	3714	2387	2228	1592	1194	1114				
8-9	Vc	20	20	20	20	20	20	20				
	fz	0.002	0.004	0.01	0.014	0.019	0.028	0.035				
	RPM	3183	2122	1592	1273	1061	796	637				
10	Vc	40	40	40	40	40	40	40				
	fz	0.003	0.006	0.011	0.018	0.023	0.036	0.045				
	RPM	6366	4244	3183	2546	2122	1592	1273				
11.1	Vc	20	20	20	20	20	20	20				
	fz	0.002	0.004	0.01	0.014	0.019	0.028	0.035				
	RPM	3183	2122	1592	1273	1061	796	637				
N	21-22	Aluminum-wrought alloy	0.1D	1.5D	Vc	105	145	140	140	150	140	135
					fz	0.005	0.009	0.014	0.019	0.021	0.036	0.048
					RPM	16711	15385	11141	8913	7958	5570	4297
					FEED	334	554	624	677	668	802	825
23-24	Aluminum-cast, alloyed	0.1D	1.5D	Vc	68	94	91	91	98	91	88	
				fz	0.005	0.009	0.014	0.019	0.021	0.036	0.048	
				RPM	10823	9974	7242	5793	5199	3621	2801	
				FEED	216	359	406	440	437	521	538	

※ The FEED, in long & extra long types, should be reduced by around 50%

▶ NEXT PAGE

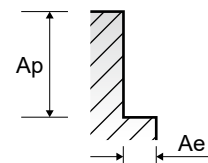

EQ595, EQ596 SERIES

MULTI FLUTE TiAlN COATED - SIDE CUTTING

Vc = m/min.
fz = mm/tooth
RPM = rev./min.
FEED = mm/min.

VDI 3323	Parameter	Diameter (Ø)											
		12.0	14.0	16.0	18.0	20.0	22.0	25.0	28.0	30.0	32.0	36.0	40.0
1	Vc	45	50	50	50	50	50	50	50	45	50	50	50
	fz	0.062	0.07	0.078	0.078	0.088	0.1	0.096	0.068	0.065	0.065	0.063	0.071
	RPM	1194	1137	995	884	796	723	637	568	477	497	442	398
2	FEED	296	318	310	276	280	289	244	232	186	194	167	170
	Vc	40	45	40	40	40	45	45	45	40	40	40	40
	fz	0.057	0.056	0.07	0.08	0.087	0.087	0.093	0.058	0.057	0.058	0.06	0.069
3-4	RPM	1061	1023	796	707	637	651	573	512	424	398	354	318
	FEED	242	229	223	226	222	227	213	178	145	138	127	132
	Vc	35	35	35	30	35	35	35	35	35	30	35	30
5	fz	0.047	0.053	0.056	0.066	0.066	0.073	0.069	0.046	0.05	0.05	0.047	0.057
	RPM	928	796	696	531	557	506	446	398	371	298	309	239
	FEED	175	169	156	140	147	148	123	110	111	90	87	82
6	Vc	20	20	20	20	20	20	20	20	20	20	15	20
	fz	0.048	0.053	0.056	0.064	0.075	0.075	0.07	0.054	0.054	0.054	0.056	0.056
	RPM	531	455	398	354	318	289	255	227	212	199	133	159
7	FEED	102	96	89	91	95	87	71	74	69	64	45	53
	Vc	40	45	40	40	40	45	45	45	40	40	40	40
	fz	0.057	0.056	0.07	0.08	0.087	0.087	0.093	0.058	0.057	0.058	0.06	0.069
8-9	RPM	1061	1023	796	707	637	651	573	512	424	398	354	318
	FEED	242	229	223	226	222	227	213	178	145	138	127	132
	Vc	35	35	35	30	35	35	35	35	35	30	35	30
10	fz	0.047	0.053	0.056	0.066	0.066	0.073	0.069	0.046	0.05	0.05	0.047	0.057
	RPM	928	796	696	531	557	506	446	398	371	298	309	239
	FEED	175	169	156	140	147	148	123	110	111	90	87	82
11.1	Vc	20	20	20	20	20	20	20	20	20	20	15	20
	fz	0.048	0.053	0.056	0.064	0.075	0.075	0.07	0.054	0.054	0.054	0.056	0.056
	RPM	531	455	398	354	318	289	255	227	212	199	133	159
21	FEED	102	96	89	91	95	87	71	74	69	64	45	53
	Vc	130	135	140	140	140	135	135	135	145	140	140	140
	fz	0.057	0.06	0.066	0.074	0.074	0.081	0.087	0.06	0.06	0.06	0.061	0.064
22	RPM	3448	3069	2785	2476	2228	1953	1719	1535	1538	1393	1238	1114
	FEED	786	737	735	733	660	633	598	552	554	501	453	428
	Vc	85	88	91	91	91	88	88	88	88	94	91	91
23	fz	0.057	0.06	0.066	0.074	0.074	0.081	0.087	0.06	0.06	0.06	0.061	0.064
	RPM	2255	2001	1810	1609	1448	1273	1120	1000	997	905	805	724
	FEED	514	480	478	476	429	413	390	360	359	326	294	278

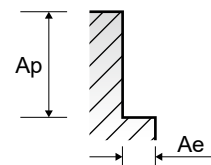

E2755, E2756 SERIES

3 FLUTE ROUGHING - SIDE CUTTING

Vc = m/min.
fz = mm/tooth
RPM = rev./min.
FEED = mm/min.

ISO	VDI 3323	Material Description	Ae	Ap	Parameter	Diameter (Ø)			
						6.0	8.0	10.0	12.0
P	1	Non-alloy steel	0.5D	1.5D	Vc	35	35	35	35
					fz	0.015	0.025	0.045	0.067
					RPM	1857	1393	1114	928
	2		Vc	30	30	30	30		
			fz	0.013	0.023	0.044	0.058		
			RPM	1592	1194	955	796		
	3-4		Vc	25	25	25	25		
			fz	0.015	0.024	0.046	0.058		
			RPM	1326	995	796	663		
	5		Vc	15	15	15	15		
fz		0.013	0.021	0.044	0.058				
RPM		796	597	477	398				
6	Vc	30	30	30	30				
	fz	0.013	0.023	0.044	0.058				
	RPM	1592	1194	955	796				
7	Vc	25	25	25	25				
	fz	0.015	0.024	0.046	0.058				
	RPM	1326	995	796	663				
8-9	Vc	15	15	15	15				
	fz	0.013	0.021	0.044	0.058				
	RPM	796	597	477	398				
10	Vc	30	30	30	30				
	fz	0.013	0.023	0.044	0.058				
	RPM	1592	1194	955	796				
11.1	Vc	15	15	15	15				
	fz	0.013	0.021	0.044	0.058				
	RPM	796	597	477	398				
N	21-22	Aluminum-wrought alloy	0.5D	1.5D	Vc	85	80	80	75
					fz	0.015	0.025	0.047	0.067
					RPM	4509	3183	2546	1989
23-24	Aluminum-cast, alloyed	0.5D	1.5D	Vc	55	52	52	49	
				fz	0.015	0.025	0.047	0.067	
				RPM	2918	2069	1655	1300	

※ The FEED, in long & extra long types, should be reduced by around 50%

▶ NEXT PAGE

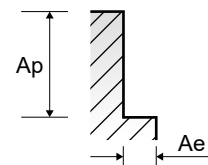

E2755, E2756 SERIES

3 FLUTE ROUGHING - SIDE CUTTING

Vc = m/min.
fz = mm/tooth
RPM = rev./min.
FEED = mm/min.

VDI 3323	Parameter	Diameter (Ø)						
		14.0	16.0	18.0	20.0	22.0	25.0	30.0
1	Vc	35	35	35	35	35	35	35
	fz	0.075	0.086	0.095	0.107	0.147	0.163	0.2
	RPM	796	696	619	557	506	446	371
	FEED	179	180	176	179	223	218	223
2	Vc	30	30	30	30	30	30	30
	fz	0.067	0.083	0.093	0.104	0.126	0.142	0.172
	RPM	682	597	531	477	434	382	318
	FEED	137	149	148	149	164	163	164
3-4	Vc	25	25	25	25	25	25	25
	fz	0.065	0.081	0.092	0.092	0.133	0.151	0.173
	RPM	568	497	442	398	362	318	265
	FEED	111	121	122	110	144	144	138
5	Vc	15	15	15	15	15	15	15
	fz	0.067	0.083	0.093	0.106	0.129	0.157	0.177
	RPM	341	298	265	239	217	191	159
	FEED	69	74	74	76	84	90	85
6	Vc	30	30	30	30	30	30	30
	fz	0.067	0.083	0.093	0.104	0.126	0.142	0.172
	RPM	682	597	531	477	434	382	318
	FEED	137	149	148	149	164	163	164
7	Vc	25	25	25	25	25	25	25
	fz	0.065	0.081	0.092	0.092	0.133	0.151	0.173
	RPM	568	497	442	398	362	318	265
	FEED	111	121	122	110	144	144	138
8-9	Vc	15	15	15	15	15	15	15
	fz	0.067	0.083	0.093	0.106	0.129	0.157	0.177
	RPM	341	298	265	239	217	191	159
	FEED	69	74	74	76	84	90	85
10	Vc	30	30	30	30	30	30	30
	fz	0.067	0.083	0.093	0.104	0.126	0.142	0.172
	RPM	682	597	531	477	434	382	318
	FEED	137	149	148	149	164	163	164
11.1	Vc	15	15	15	15	15	15	15
	fz	0.067	0.083	0.093	0.106	0.129	0.157	0.177
	RPM	341	298	265	239	217	191	159
	FEED	69	74	74	76	84	90	85
21 - 22	Vc	80	80	80	75	75	80	85
	fz	0.078	0.094	0.112	0.139	0.142	0.15	0.196
	RPM	1819	1592	1415	1194	1085	1019	902
23 - 24	Vc	52	52	52	49	49	52	55
	fz	0.078	0.094	0.112	0.139	0.142	0.15	0.196
	RPM	1182	1035	920	780	709	662	584
	FEED	277	292	309	325	302	298	343

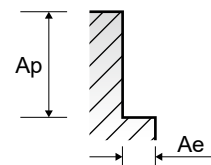

CBN END MILLS

i-Xmill END MILLS

i-SMART MODULAR END MILLS

X5070 END MILLS

4G MILL END MILLS

X-POWER PRO END MILLS

TitaNox-POWER END MILLS

JET-POWER END MILLS

V7 PLUS END MILLS

ALU-POWER HPC END MILLS

ALU-POWER END MILLS

D-POWER GRAPHITE END MILLS

D-POWER CFRP END MILLS

ROUTERS

CRX S END MILLS

K-2 END MILLS

ONLY ONE COATED PM60 END MILLS

TANK-POWER END MILLS

GENERAL HSS END MILLS

MILLING CUTTERS

TECHNICAL DATA



RECOMMENDED CUTTING CONDITIONS
EMPFOHLENE SCHNEIDPARAMETER

E2779 SERIES

MULTI FLUTE ROUGHING & FINISHING - SIDE CUTTING

Vc = m/min.
fz = mm/tooth
RPM = rev./min.
FEED = mm/min.

ISO	VDI 3323	Material Description	Ae	Ap	Parameter	Diameter (Ø)												
						16.0	18.0	20.0	22.0	25.0	28.0	30.0	32.0	36.0	40.0	45.0	50.0	
P	1	Non-alloy steel	0.5D	1.5D	Vc	35	35	35	35	35	35	35	35	35	35	35	35	35
					fz	0.052	0.058	0.065	0.07	0.078	0.071	0.081	0.081	0.091	0.095	0.099	0.11	
					RPM	696	619	557	506	446	398	371	348	309	279	248	223	
	2		0.5D	1.5D	Vc	30	30	30	30	30	30	30	30	30	30	30	30	30
					fz	0.049	0.055	0.061	0.06	0.068	0.062	0.07	0.077	0.087	0.091	0.099	0.106	
					RPM	597	531	477	434	382	341	318	298	265	239	212	191	
	3-4		0.5D	1.5D	Vc	25	25	25	25	25	25	25	25	25	25	25	25	25
					fz	0.05	0.056	0.056	0.063	0.071	0.063	0.07	0.08	0.088	0.088	0.088	0.094	
					RPM	497	442	398	362	318	284	265	249	221	199	177	159	
	5		0.5D	1.5D	Vc	15	15	15	15	15	15	15	15	15	15	15	15	15
fz		0.049			0.055	0.063	0.064	0.078	0.073	0.073	0.083	0.097	0.098	0.099	0.1			
RPM		298			265	239	217	191	171	159	149	133	119	106	95			
6	0.5D	1.5D	Vc	30	30	30	30	30	30	30	30	30	30	30	30	30		
			fz	0.049	0.055	0.061	0.06	0.068	0.062	0.07	0.077	0.087	0.091	0.099	0.106			
			RPM	597	531	477	434	382	341	318	298	265	239	212	191			
7	0.5D	1.5D	Vc	25	25	25	25	25	25	25	25	25	25	25	25	25		
			fz	0.05	0.056	0.056	0.063	0.071	0.063	0.07	0.08	0.088	0.088	0.088	0.094			
			RPM	497	442	398	362	318	284	265	249	221	199	177	159			
8-9	0.5D	1.5D	Vc	15	15	15	15	15	15	15	15	15	15	15	15	15		
			fz	0.049	0.055	0.063	0.064	0.078	0.073	0.073	0.083	0.097	0.098	0.099	0.1			
			RPM	298	265	239	217	191	171	159	149	133	119	106	95			
10	0.5D	1.5D	Vc	30	30	30	30	30	30	30	30	30	30	30	30	30		
			fz	0.049	0.055	0.061	0.06	0.068	0.062	0.07	0.077	0.087	0.091	0.099	0.106			
			RPM	597	531	477	434	382	341	318	298	265	239	212	191			
11.1	0.5D	1.5D	Vc	15	15	15	15	15	15	15	15	15	15	15	15	15		
			fz	0.049	0.055	0.063	0.064	0.078	0.073	0.073	0.083	0.097	0.098	0.099	0.1			
			RPM	298	265	239	217	191	171	159	149	133	119	106	95			
21-22	0.5D	1.5D	Vc	80	80	80	80	80	80	80	80	80	80	80	80	80		
			fz	0.056	0.068	0.083	0.069	0.072	0.076	0.078	0.083	0.09	0.095	0.1	0.11			
			RPM	1592	1415	1273	1157	1019	909	902	796	707	637	566	509			
23-24	0.5D	1.5D	Vc	52	52	52	52	52	52	52	52	52	52	52	52	52		
			fz	0.056	0.068	0.083	0.069	0.072	0.076	0.078	0.083	0.09	0.095	0.1	0.11			
			RPM	1035	920	828	752	662	591	584	517	460	414	368	331			

※ The FEED, in long & extra long types, should be reduced by around 50%

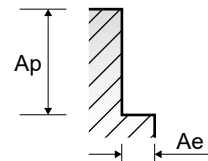

EQ779 SERIES

MULTI FLUTE ROUGHING & FINISHING TiAIN COATED - SIDE CUTTING

Vc = m/min.
fz = mm/tooth
RPM = rev./min.
FEED = mm/min.

ISO	VDI 3323	Material Description	Ae	Ap	Parameter	Diameter (Ø)												
						16.0	18.0	20.0	22.0	25.0	28.0	30.0	32.0	36.0	40.0	45.0	50.0	
P	1	Non-alloy steel	0.5D	1.5D	Vc	50	50	50	50	50	50	50	50	50	50	50	50	50
					fz	0.051	0.057	0.064	0.07	0.075	0.073	0.08	0.08	0.089	0.094	0.099	0.104	
					RPM	995	884	796	723	637	568	531	497	442	398	354	318	
	2		0.5D	1.5D	Vc	40	40	40	45	45	45	40	40	40	40	40	40	
					fz	0.048	0.055	0.06	0.058	0.069	0.06	0.067	0.075	0.086	0.094	0.102	0.11	
					RPM	796	707	637	651	573	512	424	398	354	318	283	255	
	3-4		0.5D	1.5D	Vc	35	30	35	35	35	35	30	30	30	30	30	30	
					fz	0.048	0.057	0.057	0.062	0.069	0.06	0.069	0.081	0.086	0.09	0.094	0.099	
					RPM	696	531	557	506	446	398	371	298	265	239	212	191	
	5		0.5D	1.5D	Vc	20	20	20	20	20	20	20	15	15	20	20	20	
					fz	0.047	0.054	0.063	0.067	0.08	0.083	0.083	0.098	0.111	0.1	0.103	0.106	
RPM		398			354	318	289	255	227	212	149	133	159	141	127			
6	0.5D	1.5D	Vc	40	40	40	45	45	45	40	40	40	40	40	40			
			fz	0.048	0.055	0.06	0.058	0.069	0.06	0.067	0.075	0.086	0.094	0.102	0.11			
			RPM	796	707	637	651	573	512	424	398	354	318	283	255			
7	0.5D	1.5D	Vc	35	30	35	35	35	35	30	30	30	30	30	30			
			fz	0.048	0.057	0.057	0.062	0.069	0.06	0.069	0.081	0.086	0.09	0.094	0.099			
			RPM	696	531	557	506	446	398	371	298	265	239	212	191			
8-9	0.5D	1.5D	Vc	20	20	20	20	20	20	20	15	15	20	20	20			
			fz	0.047	0.054	0.063	0.067	0.08	0.083	0.083	0.098	0.111	0.1	0.103	0.106			
			RPM	398	354	318	289	255	227	212	149	133	159	141	127			
10	0.5D	1.5D	Vc	40	40	40	45	45	45	40	40	40	40	40	40			
			fz	0.048	0.055	0.06	0.058	0.069	0.06	0.067	0.075	0.086	0.094	0.102	0.11			
			RPM	796	707	637	651	573	512	424	398	354	318	283	255			
11.1	0.5D	1.5D	Vc	20	20	20	20	20	20	20	15	15	20	20	20			
			fz	0.047	0.054	0.063	0.067	0.08	0.083	0.083	0.098	0.111	0.1	0.103	0.106			
			RPM	398	354	318	289	255	227	212	149	133	159	141	127			
21-22	0.5D	1.5D	Vc	115	110	105	105	110	110	120	110	115	115	115	115			
			fz	0.056	0.068	0.082	0.068	0.072	0.077	0.079	0.085	0.088	0.094	0.1	0.106			
			RPM	2288	1945	1671	1519	1401	1251	1273	1094	1017	915	813	732			
23-24	0.5D	1.5D	Vc	75	72	68	68	72	72	78	72	75	75	75	75			
			fz	0.056	0.068	0.082	0.068	0.072	0.077	0.079	0.085	0.088	0.094	0.1	0.106			
			RPM	1492	1273	1082	984	917	819	828	716	663	597	531	477			

※ The FEED, in long & extra long types, should be reduced by around 50%

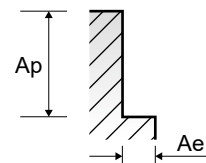

- CBN END MILLS
- i-Xmill END MILLS
- i-SMART MODULAR END MILLS
- X5070 END MILLS
- 4G MILL END MILLS
- X-POWER PRO END MILLS
- TitaNox-POWER END MILLS
- JET-POWER END MILLS
- V7 PLUS END MILLS
- ALU-POWER HPC END MILLS
- ALU-POWER END MILLS
- D-POWER GRAPHITE END MILLS
- D-POWER CFRP END MILLS
- ROUTERS
- CRX S END MILLS
- K-2 END MILLS
- ONLY ONE COATED PM60 END MILLS
- TANK-POWER END MILLS
- GENERAL HSS END MILLS
- MILLING CUTTERS
- TECHNICAL DATA

E2766, E2767 SERIES

3 FLUTE ROUGHING & FINISHING - SIDE CUTTING

Vc = m/min.
fz = mm/tooth
RPM = rev./min.
FEED = mm/min.

ISO	VDI 3323	Material Description	Ae	Ap	Parameter	Diameter (Ø)					
						6.0	8.0	10.0	12.0	14.0	16.0
P	1	Non-alloy steel	0.5D	1.5D	Vc	35	35	35	35	35	35
					fz	0.012	0.02	0.036	0.054	0.06	0.069
					RPM	1857	1393	1114	928	796	696
	2		0.5D	1.5D	Vc	30	30	30	30	30	30
					fz	0.01	0.018	0.035	0.046	0.052	0.065
					RPM	1592	1194	955	796	682	597
	3-4		0.5D	1.5D	Vc	25	25	25	25	25	25
					fz	0.013	0.019	0.038	0.048	0.054	0.067
					RPM	1326	995	796	663	568	497
	5		0.5D	1.5D	Vc	15	15	15	15	15	15
fz		0.01			0.018	0.037	0.046	0.052	0.065		
RPM		796			597	477	398	341	298		
6	0.5D	1.5D	Vc	24	32	53	55	53	58		
			fz	0.01	0.018	0.035	0.046	0.052	0.065		
			RPM	1592	1194	955	796	682	597		
7	0.5D	1.5D	Vc	48	64	100	110	106	116		
			fz	25	25	25	25	25	25		
			RPM	1326	995	796	663	568	497		
8-9	0.5D	1.5D	Vc	52	57	91	95	92	100		
			fz	15	15	15	15	15	15		
			RPM	796	597	477	398	341	298		
10	0.5D	1.5D	Vc	24	32	53	55	53	58		
			fz	0.01	0.018	0.035	0.046	0.052	0.065		
			RPM	1592	1194	955	796	682	597		
11.1	0.5D	1.5D	Vc	48	64	100	110	106	116		
			fz	15	15	15	15	15	15		
			RPM	796	597	477	398	341	298		
N	21-22	Aluminum-wrought alloy	0.5D	1.5D	Vc	24	32	53	55	53	58
					fz	0.01	0.018	0.037	0.046	0.052	0.065
					RPM	796	597	477	398	341	298
23-24	0.5D	1.5D	Vc	55	52	52	52	52	52		
			fz	0.012	0.02	0.037	0.053	0.063	0.075		
			RPM	2918	2069	1655	1379	1182	1035		

※ The FEED, in long & extra long types, should be reduced by around 50%

▶ NEXT PAGE

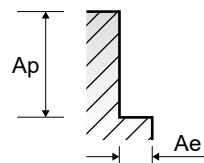

E2766, E2767 SERIES

3 FLUTE ROUGHING & FINISHING - SIDE CUTTING

Vc = m/min.
fz = mm/tooth
RPM = rev./min.
FEED = mm/min.

VDI 3323	Parameter	18.0	20.0	22.0	25.0	28.0	30.0	32.0	36.0	40.0
1	Vc	35	35	35	35	35	35	35	35	35
	fz	0.077	0.086	0.117	0.13	0.142	0.162	0.162	0.183	0.19
	RPM	619	557	506	446	398	371	348	309	279
	FEED	143	144	178	174	170	180	169	170	159
2	Vc	30	30	30	30	30	30	30	30	30
	fz	0.073	0.081	0.1	0.113	0.124	0.14	0.155	0.173	0.182
	RPM	531	477	434	382	341	318	298	265	239
	FEED	116	116	130	129	127	134	139	138	130
3-4	Vc	25	25	25	25	25	25	25	25	25
	fz	0.075	0.075	0.105	0.118	0.125	0.14	0.159	0.175	0.176
	RPM	442	398	362	318	284	265	249	221	199
	FEED	99	90	114	113	107	111	119	116	105
5	Vc	15	15	15	15	15	15	15	15	15
	fz	0.073	0.083	0.106	0.13	0.146	0.146	0.167	0.194	0.197
	RPM	265	239	217	191	171	159	149	133	119
	FEED	58	59	69	74	75	70	75	77	71
6	Vc	30	30	30	30	30	30	30	30	30
	fz	0.073	0.081	0.1	0.113	0.124	0.14	0.155	0.173	0.182
	RPM	531	477	434	382	341	318	298	265	239
	FEED	116	116	130	129	127	134	139	138	130
7	Vc	25	25	25	25	25	25	25	25	25
	fz	0.075	0.075	0.105	0.118	0.125	0.14	0.159	0.175	0.176
	RPM	442	398	362	318	284	265	249	221	199
	FEED	99	90	114	113	107	111	119	116	105
8-9	Vc	15	15	15	15	15	15	15	15	15
	fz	0.073	0.083	0.106	0.13	0.146	0.146	0.167	0.194	0.197
	RPM	265	239	217	191	171	159	149	133	119
	FEED	58	59	69	74	75	70	75	77	71
10	Vc	30	30	30	30	30	30	30	30	30
	fz	0.073	0.081	0.1	0.113	0.124	0.14	0.155	0.173	0.182
	RPM	531	477	434	382	341	318	298	265	239
	FEED	116	116	130	129	127	134	139	138	130
11.1	Vc	15	15	15	15	15	15	15	15	15
	fz	0.073	0.083	0.106	0.13	0.146	0.146	0.167	0.194	0.197
	RPM	265	239	217	191	171	159	149	133	119
	FEED	58	59	69	74	75	70	75	77	71
21 - 22	Vc	80	80	80	80	80	85	80	80	80
	fz	0.09	0.111	0.115	0.12	0.152	0.156	0.167	0.181	0.19
	RPM	1415	1273	1157	1019	909	902	796	707	637
	FEED	382	424	399	367	415	422	399	384	363
23 - 24	Vc	52	52	52	52	52	55	52	52	52
	fz	0.09	0.111	0.115	0.12	0.152	0.156	0.167	0.181	0.19
	RPM	920	828	752	662	591	584	517	460	414
	FEED	248	276	260	238	270	273	259	250	236

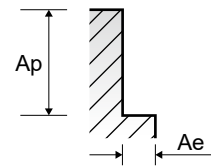

EQ766, EQ767 SERIES

3 FLUTE ROUGHING & FINISHING TIAN COATED - SIDE CUTTING

Vc = m/min.
fz = mm/tooth
RPM = rev./min.
FEED = mm/min.

ISO	VDI 3323	Material Description	Ae	Ap	Parameter	Diameter (Ø)					
						6.0	8.0	10.0	12.0	14.0	16.0
P	1	Non-alloy steel	0.5D	1.5D	Vc	50	50	50	50	50	50
					fz	0.012	0.021	0.037	0.055	0.062	0.068
					RPM	2653	1989	1592	1326	1137	995
	2		Vc	40	40	40	40	45	40		
			fz	0.01	0.018	0.036	0.047	0.052	0.065		
			RPM	2122	1592	1273	1061	1023	796		
	3-4		Vc	64	86	138	150	160	155		
			fz	30	30	35	35	35	35		
			RPM	1592	1194	1114	928	796	696		
	5		Vc	62	68	127	128	124	134		
fz		20	20	20	20	20	20				
RPM		1061	796	637	531	455	398				
6	Vc	35	41	69	72	68	75				
	fz	40	40	40	40	45	40				
	RPM	2122	1592	1273	1061	1023	796				
7	Vc	64	86	138	150	160	155				
	fz	30	30	35	35	35	35				
	RPM	1592	1194	1114	928	796	696				
8-9	Vc	62	68	127	128	124	134				
	fz	20	20	20	20	20	20				
	RPM	1061	796	637	531	455	398				
10	Vc	35	41	69	72	68	75				
	fz	40	40	40	40	45	40				
	RPM	2122	1592	1273	1061	1023	796				
11.1	Vc	64	86	138	150	160	155				
	fz	20	20	20	20	20	20				
	RPM	1061	796	637	531	455	398				
N	21-22	Aluminum-wrought alloy	0.5D	1.5D	Vc	120	110	110	105	110	115
					fz	0.012	0.02	0.037	0.054	0.063	0.075
					RPM	6366	4377	3501	2785	2501	2288
23-24	Aluminum-cast, alloyed	0.5D	1.5D	Vc	229	263	389	451	473	515	
				fz	78	72	72	68	72	75	
				RPM	4138	2865	2292	1804	1637	1492	
FEED	149	172	254	292	309	336					

※ The FEED, in long & extra long types, should be reduced by around 50%

▶ NEXT PAGE

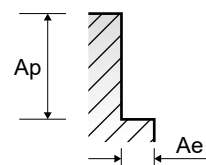

EQ766, EQ767 SERIES

3 FLUTE ROUGHING & FINISHING TiAlN COATED - SIDE CUTTING

Vc = m/min.
fz = mm/tooth
RPM = rev./min.
FEED = mm/min.

VDI 3323	Parameter	Diameter (Ø)								
		18.0	20.0	22.0	25.0	28.0	30.0	32.0	36.0	40.0
1	Vc	50	50	50	50	50	50	50	50	50
	fz	0.076	0.085	0.117	0.126	0.145	0.16	0.16	0.178	0.188
	RPM	884	796	723	637	568	531	497	442	398
	FEED	202	203	254	241	247	255	239	236	224
2	Vc	40	40	45	45	45	40	40	40	40
	fz	0.074	0.079	0.097	0.115	0.12	0.133	0.15	0.171	0.189
	RPM	707	637	651	573	512	424	398	354	318
	FEED	157	151	189	198	184	169	179	181	180
3-4	Vc	30	35	35	35	35	35	30	30	30
	fz	0.076	0.076	0.103	0.115	0.121	0.138	0.161	0.173	0.18
	RPM	531	557	506	446	398	371	298	265	239
	FEED	121	127	156	154	144	154	144	138	129
5	Vc	20	20	20	20	20	20	15	15	20
	fz	0.071	0.083	0.111	0.133	0.167	0.167	0.196	0.222	0.2
	RPM	354	318	289	255	227	212	149	133	159
	FEED	75	79	96	102	114	106	88	88	95
6	Vc	40	40	45	45	45	40	40	40	40
	fz	0.074	0.079	0.097	0.115	0.12	0.133	0.15	0.171	0.189
	RPM	707	637	651	573	512	424	398	354	318
	FEED	157	151	189	198	184	169	179	181	180
7	Vc	30	35	35	35	35	35	30	30	30
	fz	0.076	0.076	0.103	0.115	0.121	0.138	0.161	0.173	0.18
	RPM	531	557	506	446	398	371	298	265	239
	FEED	121	127	156	154	144	154	144	138	129
8-9	Vc	20	20	20	20	20	20	15	15	20
	fz	0.071	0.083	0.111	0.133	0.167	0.167	0.196	0.222	0.2
	RPM	354	318	289	255	227	212	149	133	159
	FEED	75	79	96	102	114	106	88	88	95
10	Vc	40	40	45	45	45	40	40	40	40
	fz	0.074	0.079	0.097	0.115	0.12	0.133	0.15	0.171	0.189
	RPM	707	637	651	573	512	424	398	354	318
	FEED	157	151	189	198	184	169	179	181	180
11.1	Vc	20	20	20	20	20	20	15	15	20
	fz	0.071	0.083	0.111	0.133	0.167	0.167	0.196	0.222	0.2
	RPM	354	318	289	255	227	212	149	133	159
	FEED	75	79	96	102	114	106	88	88	95
21 - 22	Vc	110	105	105	110	110	120	110	115	115
	fz	0.091	0.11	0.114	0.12	0.153	0.157	0.17	0.177	0.187
	RPM	1945	1671	1519	1401	1251	1273	1094	1017	915
	FEED	531	551	520	504	574	600	558	540	513
23 - 24	Vc	72	68	68	72	72	78	72	75	75
	fz	0.091	0.11	0.114	0.12	0.153	0.157	0.17	0.177	0.187
	RPM	1273	1082	984	917	819	828	716	663	597
	FEED	348	357	336	330	376	390	365	352	335

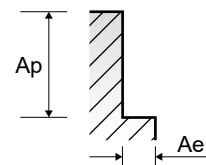

E2754, E2768 SERIES

MULTI FLUTE ROUGHING & FINISHING - SIDE CUTTING

Vc = m/min.
fz = mm/tooth
RPM = rev./min.
FEED = mm/min.

ISO	VDI 3323	Material Description	Ae	Ap	Parameter	Diameter (Ø)					
						6.0	8.0	10.0	12.0	14.0	16.0
P	1	Non-alloy steel	0.5D	1.5D	Vc	35	35	35	35	35	35
					fz	0.012	0.015	0.027	0.04	0.045	0.052
					RPM	1857	1393	1114	928	796	696
	2		Vc	30	30	30	30	30	30		
			fz	0.01	0.014	0.026	0.034	0.039	0.049		
			RPM	1592	1194	955	796	682	597		
	3-4		Vc	25	25	25	25	25	25		
			fz	0.013	0.014	0.028	0.036	0.04	0.05		
			RPM	1326	995	796	663	568	497		
	5		Vc	15	15	15	15	15	15		
fz		0.01	0.013	0.028	0.034	0.039	0.049				
RPM		796	597	477	398	341	298				
6	Vc	24	31	53	54	53	58				
	fz	0.01	0.014	0.026	0.034	0.039	0.049				
	RPM	1592	1194	955	796	682	597				
7	Vc	48	67	99	108	106	117				
	fz	25	25	25	25	25	25				
	RPM	1326	995	796	663	568	497				
8-9	Vc	52	56	89	95	91	99				
	fz	15	15	15	15	15	15				
	RPM	796	597	477	398	341	298				
10	Vc	24	31	53	54	53	58				
	fz	0.01	0.014	0.026	0.034	0.039	0.049				
	RPM	1592	1194	955	796	682	597				
11.1	Vc	48	67	99	108	106	117				
	fz	15	15	15	15	15	15				
	RPM	796	597	477	398	341	298				
N	21-22	Aluminum-wrought alloy	0.5D	1.5D	Vc	24	31	53	54	53	58
					fz	0.01	0.013	0.028	0.034	0.039	0.049
					RPM	796	597	477	398	341	298
23-24	Aluminum-cast, alloyed	0.5D	1.5D	Vc	85	80	80	80	80	80	
				fz	0.012	0.015	0.028	0.04	0.047	0.056	
				RPM	4509	3183	2546	2122	1819	1592	
					Vc	162	191	285	340	342	357
					fz	55	52	52	52	52	52
					RPM	2918	2069	1655	1379	1182	1035
					Vc	105	124	185	221	222	232
					fz	0.012	0.015	0.028	0.04	0.047	0.056
					RPM	2918	2069	1655	1379	1182	1035

※ The FEED, in long & extra long types, should be reduced by around 50%

▶ NEXT PAGE

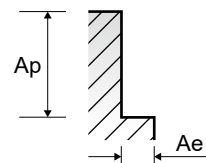

E2754, E2768 SERIES

MULTI FLUTE ROUGHING & FINISHING - SIDE CUTTING

Vc = m/min.
fz = mm/tooth
RPM = rev./min.
FEED = mm/min.

VDI 3323	Parameter	Diameter (Ø)								
		18.0	20.0	22.0	25.0	28.0	30.0	32.0	36.0	40.0
1	Vc	35	35	35	35	35	35	35	35	35
	fz	0.058	0.065	0.07	0.078	0.085	0.097	0.097	0.091	0.095
	RPM	619	557	506	446	398	371	348	309	279
	FEED	144	145	177	174	169	180	169	169	159
2	Vc	30	30	30	30	30	30	30	30	30
	fz	0.055	0.061	0.06	0.068	0.074	0.084	0.093	0.087	0.091
	RPM	531	477	434	382	341	318	298	265	239
	FEED	117	117	130	130	126	134	139	138	130
3-4	Vc	25	25	25	25	25	25	25	25	25
	fz	0.056	0.056	0.063	0.071	0.075	0.084	0.095	0.088	0.088
	RPM	442	398	362	318	284	265	249	221	199
	FEED	99	89	114	113	107	111	118	117	105
5	Vc	15	15	15	15	15	15	15	15	15
	fz	0.055	0.063	0.064	0.078	0.088	0.088	0.1	0.097	0.098
	RPM	265	239	217	191	171	159	149	133	119
	FEED	58	60	69	74	75	70	75	77	70
6	Vc	30	30	30	30	30	30	30	30	30
	fz	0.055	0.061	0.06	0.068	0.074	0.084	0.093	0.087	0.091
	RPM	531	477	434	382	341	318	298	265	239
	FEED	117	117	130	130	126	134	139	138	130
7	Vc	25	25	25	25	25	25	25	25	25
	fz	0.056	0.056	0.063	0.071	0.075	0.084	0.095	0.088	0.088
	RPM	442	398	362	318	284	265	249	221	199
	FEED	99	89	114	113	107	111	118	117	105
8-9	Vc	15	15	15	15	15	15	15	15	15
	fz	0.055	0.063	0.064	0.078	0.088	0.088	0.1	0.097	0.098
	RPM	265	239	217	191	171	159	149	133	119
	FEED	58	60	69	74	75	70	75	77	70
10	Vc	30	30	30	30	30	30	30	30	30
	fz	0.055	0.061	0.06	0.068	0.074	0.084	0.093	0.087	0.091
	RPM	531	477	434	382	341	318	298	265	239
	FEED	117	117	130	130	126	134	139	138	130
11.1	Vc	15	15	15	15	15	15	15	15	15
	fz	0.055	0.063	0.064	0.078	0.088	0.088	0.1	0.097	0.098
	RPM	265	239	217	191	171	159	149	133	119
	FEED	58	60	69	74	75	70	75	77	70
21 - 22	Vc	80	80	80	80	80	85	80	80	80
	fz	0.068	0.083	0.069	0.072	0.091	0.093	0.1	0.09	0.095
	RPM	1415	1273	1157	1019	909	902	796	707	637
	FEED	385	423	399	367	414	419	398	382	363
23 - 24	Vc	52	52	52	52	52	55	52	52	52
	fz	0.068	0.083	0.069	0.072	0.091	0.093	0.1	0.09	0.095
	RPM	920	828	752	662	591	584	517	460	414
	FEED	250	275	260	238	269	271	259	248	236

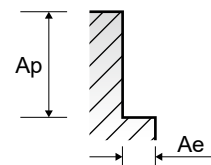

CBN END MILLS

i-Xmill END MILLS

i-SMART MODULAR END MILLS

X5070 END MILLS

4G MILL END MILLS

X-POWER PRO END MILLS

TitaNox-POWER END MILLS

JET-POWER END MILLS

V7 PLUS END MILLS

ALU-POWER HPC END MILLS

ALU-POWER END MILLS

D-POWER GRAPHITE END MILLS

D-POWER CFRP END MILLS

ROUTERS

CRX S END MILLS

K-2 END MILLS

ONLY ONE COATED PM60 END MILLS

TANK-POWER END MILLS

GENERAL HSS END MILLS

MILLING CUTTERS

TECHNICAL DATA

EQ754, EQ768 SERIES

MULTI FLUTE ROUGHING & FINISHING TiAlN COATED - SIDE CUTTING

Vc = m/min.
fz = mm/tooth
RPM = rev./min.
FEED = mm/min.

ISO	VDI 3323	Material Description	Ae	Ap	Parameter	Diameter (Ø)					
						6.0	8.0	10.0	12.0	14.0	16.0
P	1	Non-alloy steel	0.5D	1.5D	Vc	50	50	50	50	50	50
					fz	0.012	0.015	0.027	0.041	0.047	0.051
					RPM	2653	1989	1592	1326	1137	995
	2		0.5D	1.5D	Vc	40	40	40	40	45	40
					fz	0.01	0.014	0.027	0.035	0.039	0.048
					RPM	2122	1592	1273	1061	1023	796
	3-4		0.5D	1.5D	Vc	30	30	35	35	35	35
					fz	0.013	0.014	0.028	0.035	0.039	0.048
					RPM	1592	1194	1114	928	796	696
	5		0.5D	1.5D	Vc	20	20	20	20	20	20
					fz	0.011	0.013	0.027	0.034	0.038	0.047
RPM		1061			796	637	531	455	398		
6	0.5D	1.5D	Vc	40	40	40	40	45	40		
			fz	0.01	0.014	0.027	0.035	0.039	0.048		
			RPM	2122	1592	1273	1061	1023	796		
7	0.5D	1.5D	Vc	30	30	35	35	35	35		
			fz	0.013	0.014	0.028	0.035	0.039	0.048		
			RPM	1592	1194	1114	928	796	696		
8-9	0.5D	1.5D	Vc	20	20	20	20	20	20		
			fz	0.011	0.013	0.027	0.034	0.038	0.047		
			RPM	1061	796	637	531	455	398		
10	0.5D	1.5D	Vc	40	40	40	40	45	40		
			fz	0.01	0.014	0.027	0.035	0.039	0.048		
			RPM	2122	1592	1273	1061	1023	796		
11.1	0.5D	1.5D	Vc	20	20	20	20	20	20		
			fz	0.011	0.013	0.027	0.034	0.038	0.047		
			RPM	1061	796	637	531	455	398		
N	21-22	Aluminum-wrought alloy	0.5D	1.5D	Vc	120	110	110	105	110	115
					fz	0.012	0.015	0.028	0.04	0.048	0.056
					RPM	6366	4377	3501	2785	2501	2288
23-24	0.5D	1.5D	Vc	78	72	72	68	72	75		
			fz	0.012	0.015	0.028	0.04	0.048	0.056		
			RPM	4138	2865	2292	1804	1637	1492		

※ The FEED, in long & extra long types, should be reduced by around 50%

▶ NEXT PAGE

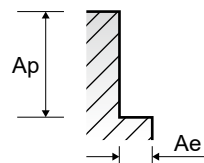

EQ754, EQ768 SERIES

MULTI FLUTE ROUGHING & FINISHING TiN COATED - SIDE CUTTING

Vc = m/min.
fz = mm/tooth
RPM = rev./min.
FEED = mm/min.

VDI 3323	Parameter	Diameter (Ø)								
		18.0	20.0	22.0	25.0	28.0	30.0	32.0	36.0	40.0
1	Vc	50	50	50	50	50	50	50	50	50
	fz	0.057	0.064	0.07	0.075	0.087	0.096	0.096	0.089	0.094
	RPM	884	796	723	637	568	531	497	442	398
	FEED	202	204	253	239	247	255	239	236	224
2	Vc	40	40	45	45	45	40	40	40	40
	fz	0.055	0.06	0.058	0.069	0.072	0.08	0.09	0.086	0.094
	RPM	707	637	651	573	512	424	398	354	318
	FEED	156	153	189	198	184	170	179	182	180
3-4	Vc	30	35	35	35	35	35	30	30	30
	fz	0.057	0.057	0.062	0.069	0.073	0.083	0.097	0.086	0.09
	RPM	531	557	506	446	398	371	298	265	239
	FEED	121	127	157	154	145	154	145	137	129
5	Vc	20	20	20	20	20	20	15	15	20
	fz	0.054	0.063	0.067	0.08	0.1	0.1	0.118	0.111	0.1
	RPM	354	318	289	255	227	212	149	133	159
	FEED	76	80	97	102	114	106	88	88	95
6	Vc	40	40	45	45	45	40	40	40	40
	fz	0.055	0.06	0.058	0.069	0.072	0.08	0.09	0.086	0.094
	RPM	707	637	651	573	512	424	398	354	318
	FEED	156	153	189	198	184	170	179	182	180
7	Vc	30	35	35	35	35	35	30	30	30
	fz	0.057	0.057	0.062	0.069	0.073	0.083	0.097	0.086	0.09
	RPM	531	557	506	446	398	371	298	265	239
	FEED	121	127	157	154	145	154	145	137	129
8-9	Vc	20	20	20	20	20	20	15	15	20
	fz	0.054	0.063	0.067	0.08	0.1	0.1	0.118	0.111	0.1
	RPM	354	318	289	255	227	212	149	133	159
	FEED	76	80	97	102	114	106	88	88	95
10	Vc	40	40	45	45	45	40	40	40	40
	fz	0.055	0.06	0.058	0.069	0.072	0.08	0.09	0.086	0.094
	RPM	707	637	651	573	512	424	398	354	318
	FEED	156	153	189	198	184	170	179	182	180
11.1	Vc	20	20	20	20	20	20	15	15	20
	fz	0.054	0.063	0.067	0.08	0.1	0.1	0.118	0.111	0.1
	RPM	354	318	289	255	227	212	149	133	159
	FEED	76	80	97	102	114	106	88	88	95
21 - 22	Vc	110	105	105	110	110	120	110	115	115
	fz	0.068	0.082	0.068	0.072	0.092	0.094	0.102	0.088	0.094
	RPM	1945	1671	1519	1401	1251	1273	1094	1017	915
	FEED	529	548	517	504	575	598	558	537	516
23 - 24	Vc	72	68	68	72	72	78	72	75	75
	fz	0.068	0.082	0.068	0.072	0.092	0.094	0.102	0.088	0.094
	RPM	1273	1082	984	917	819	828	716	663	597
	FEED	346	355	335	330	377	389	365	350	337

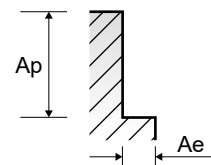



Global Cutting Tool Leader **YG-1**



MILLING



Leading Through Innovation

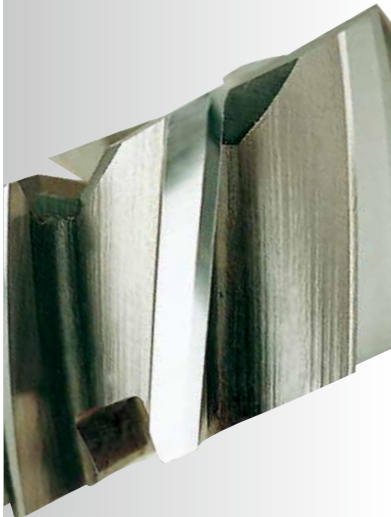

HSS

MILLING CUTTERS

HSS Fräser

- General Works. Available Dovetail, Woodruff Keyseat, T-slot, Side Milling Cutters and HSS (8% cobalt) Corner Rounding, Shell End Mills
- Allgemeine Arbeiten. Verfügbare Schwalbenschwanz, Passfedernut, T-Nut, Scheibenfräser, Scheibenfräser und HSS (8% Kobalt) Eckenverrundung, Walzenstirnfräser

SELECTION GUIDE



MILLING TOOLS

SERIES	ML012, ML022	ML032, ML042	ML062
	ML112, ML122	ML132, ML142	ML162
	ML212, ML222	ML232, ML242	ML262
DOVETAIL CUTTERS	DOVETAIL CUTTERS	WOODRUFF KEYSEAT CUTTERS	
FLUTE	-	-	-
HELIX ANGLE	0°	0°	10°-20°
SIZE MIN	D16.0	D16.0	D10.5
SIZE MAX	D50.0	D38.0	D45.5
PAGE	792	793	794

**HSS
MILLING
CUTTERS**

General Works. Available Dovetail, Woodruff Keyseat, T-slot, Side Milling Cutters and HSS (8% cobalt) Corner Rounding, Shell End Mills



Please visit globalyg1.com/mat for material search

◎ : Excellent ○ : Good

Recommended cutting conditions : P 811



ISO	VDI 3323	Material Description	Composition / Structure / Heat Treatment	HB	HRc			
P	1	Non-alloy steel	About 0.15% C Annealed	125		◎	◎	◎
	2		About 0.45% C Annealed	190	13	◎	◎	◎
	3		About 0.45% C Quenched & Tempered	250	25	◎	◎	◎
	4		About 0.75% C Annealed	270	28	◎	◎	◎
	5		About 0.75% C Quenched & Tempered	300	32	◎	◎	◎
	6	Low alloy steel	Annealed	180	10	◎	◎	◎
	7		Quenched & Tempered	275	29	◎	◎	◎
	8		Quenched & Tempered	300	32	◎	◎	◎
	9		Quenched & Tempered	350	38	○	○	○
	10		High alloyed steel, and tool steel	Annealed	200	15	◎	◎
	11	Quenched & Tempered		325	35	○	○	○
M	12	Stainless steel	Ferritic / Martensitic Annealed	200	15			
	13		Martensitic Quenched & Tempered	240	23			
	14		Austenitic	180	10			
K	15	Grey cast iron	Pearlitic / ferritic	180	10			
	16		Pearlitic (Martensitic)	260	26			
	17	Nodular cast iron	Ferritic	160	3			
	18		Pearlitic	250	25			
	19	Malleable cast iron	Ferritic	130				
20	Pearlitic		230	21				
N	21	Aluminum-wrought alloy	Not Curable	60		○	○	○
	22		Curable Hardened	100		○	○	○
	23	Aluminum-cast, alloyed	≤ 12% Si, Not Curable	75		○	○	○
	24		≤ 12% Si, Curable Hardened	90		○	○	○
	25		> 12% Si, Not Curable	130		○	○	○
	26		Copper and Copper Alloys	Cutting Alloys, PB>1%	110			
	27	(Bronze / Brass)	CuZn, CuSnZn (Brass)	90				
	28		CuSn, lead-free copper and electrolytic copper	100				
	29	Non Metallic Materials	Duroplastic, Fiber Reinforced Plastic					
	30		Rubber, Wood, etc.					
S	31	Heat Resistant Super Alloys	Fe Based Annealed	200	15			
	32		Cured	280	30			
	33		Annealed	250	25			
	34		Ni or Co Based Cured	350	38			
	35	Cast	320	34				
	36	Titanium Alloys	Pure Titanium	400 Rm				
	37		Alpha + Beta Alloys Hardened	1050 Rm				
H	38	Hardened steel	Hardened	550	55			
	39		Hardened	630	60			
	40	Chilled Cast Iron	Cast	400	42			
	41	Hardened Cast Iron	Hardened	550	55			



PLAIN SHANK **ML012, ML022** SERIES
 FLAT SHANK **ML112, ML122** SERIES
 THREAD SHANK **ML212, ML222** SERIES

HSS-E, DOVETAIL CUTTERS TYPE "A", "C", "E"

- HSS-E, WINKELFRÄSER FORM "A", "C", "E"
- Fraise HSS-E pour queue d'aronde Type "A", "C", "E"
- FRESE AD ANGOLO DIVERGENTE TIPO "A", "C", "E"

▶ Recommended for use in place of arbor and threaded hole type cutters to reduce set time and facilitate handling.

▶ Empfohlen zur Nutzung anstelle von Arbor und threaded hole type Cutters um Montierzeit zu verkürzen und Handhabung zu erleichtern.

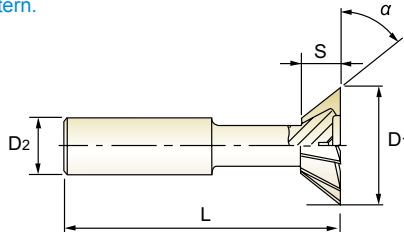
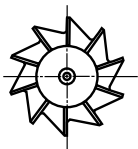

HSS-E
DIN 1833
N
0°
DIN 1835A
DIN 1835B
DIN 1835D
P.812

Unit : mm

EDP No.			Cutter Diameter	Width of Face	Divergent Taper Angle	Shank Diameter	Overall Length	No. of Teeth
PLAIN	FLAT	THREAD	D1(js16)	S(js14)	α(± 15°)	D2(h6)	L(js18)	Z
ML01201601	ML11201601	-	16.0	4	45°	12	60	6
ML01202001	ML11202001	▲ ML21202001	20.0	5	45°	12	63	6
ML01202201	ML11202201	-	22.0	6	45°	12	67	6
ML01202501	ML11202501	▲ ML21202501	25.0	6.3	45°	16	67	8
ML01202801	ML11202801	-	28.0	7.5	45°	16	67	8
ML01203201	ML11203201	-	32.0	8	45°	16	71	10
ML01203801	ML11203801	-	38.0	10	45°	16	80	12
ML02201601	ML12201601	▲ ML22201601	16.0	6.3	60°	12	60	6
ML02202001	ML12202001	-	20.0	8	60°	12	63	6
ML02202201	ML12202201	-	22.0	9	60°	12	67	6
ML02202501	ML12202501	-	25.0	10	60°	16	67	8
ML02202801	ML12202801	-	28.0	11	60°	16	67	8
ML02203201	ML12203201	-	32.0	12.5	60°	16	71	10
ML02203801	ML12203801	-	38.0	16	60°	16	80	12
ML02204001	ML12204001	▲ ML22204001	40.0	13	60°	25	85	12
ML02205001	ML12205001	-	50.0	16	60°	25	100	16

▲ : Only available till stock runs out

Tolerances according to DIN 7160 & 7161

	Nominal-Diameter in mm						
	over3 to 6	over6 to 10	over10 to 18	over18 to 30	over30 to 50	over50 to 80	over80 to 120
Tolerance range in mm							
js16	± 0.375	± 0.45	± 0.55	± 0.65	± 0.80	± 0.95	± 1.10
js14	± 0.15	± 0.18	± 0.215	± 0.26	± 0.31	± 0.37	± 0.435
js18	± 0.90	± 1.10	± 1.35	± 1.65	± 1.95	± 2.30	± 2.70
Tolerance range in μm							
h6	0 - 8	0 - 9	0 - 11	0 - 13	0 - 16	0 - 19	0 - 22

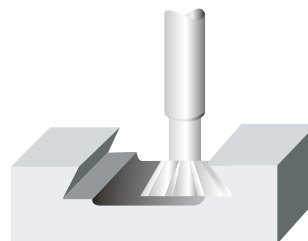

◎ : Excellent ○ : Good

ISO Material Description	P											M			K						
	Non-alloy steel					Low alloy steel				High alloyed steel, and tool steel		Stainless steel			Grey cast iron		Nodular cast iron		Malleable cast iron		
VDI 3323	1	2	3	4	5	6	7	8	9	10	11	12	13	14	15	16	17	18	19	20	
HRc		13	25	28	32	10	29	32	38	15	35	15	23	10	10	26	3	25		21	
HB	125	190	250	270	300	180	275	300	350	200	325	200	240	180	180	260	160	250	130	230	
Recommended	◎	◎	◎	◎	◎	◎	◎	◎	◎	◎	◎	◎	◎	◎	◎	◎	◎	◎	◎	◎	
ISO Material Description	N										S							H			
	Aluminum-wrought alloy		Aluminum-cast, alloyed			Copper and Copper Alloys (Bronze / Brass)			Non Metallic Materials		Heat Resistant Super Alloys					Titanium Alloys		Hardened steel	Chilled Cast Iron	Hardened Cast Iron	
VDI 3323	21	22	23	24	25	26	27	28	29	30	31	32	33	34	35	36	37	38	39	40	41
HRc											15	30	25	38	34			55	60	42	55
HB	60	100	75	90	130	110	90	100			200	280	250	350	320	400 Rm	1050 Rm	550	630	400	550
Recommended	◎	◎	◎	◎	◎																

HSS-E, DOVETAIL CUTTERS TYPE "B", "D", "F"

- HSS-E, WINKELFRÄSER FORM "B", "D", "F"
- Fraise HSS-E pour queue d'arronde Type "B", "D", "F"
- FRESE AD ANGOLO CONVERGENTE TIPO "B", "D", "F"

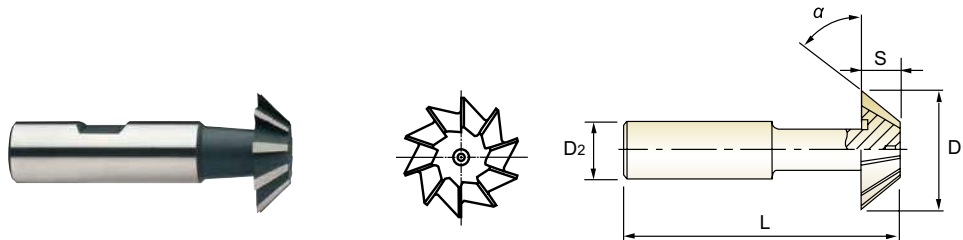

EDP No.			Cutter Diameter	Width of Face	Divergent Taper Angle	Shank Diameter	Overall Length	No. of Teeth
PLAIN	FLAT	THREAD	D1(js16)	S(js14)	$\alpha(\pm 15^\circ)$	D2(h6)	L(js18)	Z
ML03201601	ML13201601	-	16.0	4	45°	12	60	6
ML03202001	ML13202001	-	20.0	5	45°	12	63	6
ML03202201	ML13202201	-	22.0	6	45°	12	67	6
ML03202501	ML13202501	▲ ML23202501	25.0	6.3	45°	16	67	8
ML03202801	ML13202801	-	28.0	7.5	45°	16	67	8
ML03203201	ML13203201	-	32.0	8	45°	16	71	10
ML03203801	ML13203801	-	38.0	10	45°	16	80	12
ML04201601	ML14201601	-	16.0	6.3	60°	12	60	6
ML04202001	ML14202001	▲ ML24202001	20.0	8	60°	12	63	6
ML04202201	ML14202201	-	22.0	9	60°	12	67	6
ML04202501	ML14202501	-	25.0	10	60°	16	67	8
ML04202801	ML14202801	-	28.0	11	60°	16	67	8
ML04203201	ML14203201	-	32.0	12.5	60°	16	71	10
ML04203801	ML14203801	-	38.0	16	60°	16	80	12

▲ : Only available till stock runs out

Tolerances according to DIN 7160 & 7161

	Nominal-Diameter in mm						
	over3 to 6	over6 to 10	over10 to 18	over18 to 30	over30 to 50	over50 to 80	over80 to 120
	Tolerance range in mm						
js16	± 0.375	± 0.45	± 0.55	± 0.65	± 0.80	± 0.95	± 1.10
js14	± 0.15	± 0.18	± 0.215	± 0.26	± 0.31	± 0.37	± 0.435
js18	± 0.90	± 1.10	± 1.35	± 1.65	± 1.95	± 2.30	± 2.70
	Tolerance range in μm						
h6	0 - 8	0 - 9	0 - 11	0 - 13	0 - 16	0 - 19	0 - 22

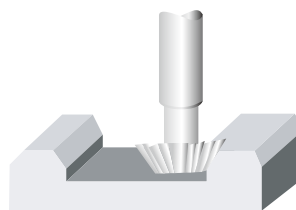

◎ : Excellent ○ : Good

ISO Material Description	P										M			K						
	Non-alloy steel					Low alloy steel					High alloyed steel, and tool steel			Stainless steel			Grey cast iron		Nodular cast iron	
VDI 3323	1	2	3	4	5	6	7	8	9	10	11	12	13	14	15	16	17	18	19	20
HRc	13	25	28	32	10	29	32	38	15	35	15	23	10	10	26	3	25	42	21	
HB	125	190	250	270	300	180	275	300	350	200	325	200	180	180	260	160	250	130	230	
Recommended	◎	◎	◎	◎	◎	◎	◎	◎	○	◎	◎	◎	◎	◎	◎	◎	◎	◎	◎	

ISO Material Description	N					S					H										
	Aluminum-wrought alloy		Aluminum-cast, alloyed		Copper and Copper Alloys (Bronze / Brass)	Non Metallic Materials	Heat Resistant Super Alloys			Titanium Alloys		Hardened steel	Chilled Cast Iron	Hardened Cast Iron							
VDI 3323	21	22	23	24	25	26	27	28	29	30	31	32	33	34	35	36	37	38	39	40	41
HRc	60	100	75	90	130	110	90	100			15	30	25	38	34	55	60	55	60	42	55
HB	60	100	75	90	130	110	90	100			200	280	250	350	320	400 Rm	1050 Rm	550	630	400	550
Recommended	○	○	○	○	○																



PLAIN SHANK	ML062 SERIES
FLAT SHANK	ML162 SERIES
THREAD SHANK	ML262 SERIES

HSS-E, WOODRUFF KEYSEAT CUTTERS TYPE "B", "D", "F"

- HSS-E, SCHLITZFRÄSER FORM "B", "D", "F"
- Fraise HSS-E WOODRUFF Type "B", "D", "F"
- FRESE PER CHIAVETTE WOODRUFF TIPO "B", "D", "F"

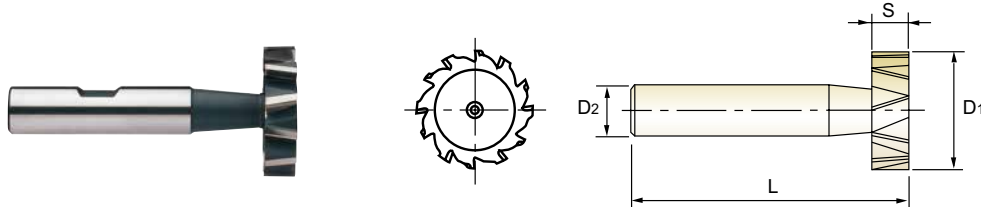

Unit : mm

EDP No.	Cutter Diameter			Width of Face	Shank Diameter	Overall Length	No. of Teeth
	PLAIN	FLAT	THREAD				
ML06210E01	ML16210E01	-	10.5	2	6	50	8
ML06210E02	ML16210E02	-	10.5	2.5	6	50	8
ML06210E03	ML16210E03	-	10.5	3	6	50	8
ML06213E01	ML16213E01	-	13.5	2	10	56	8
ML06213E02	ML16213E02	-	13.5	2.5	10	56	8
ML06213E03	ML16213E03	-	13.5	3	10	56	8
ML06213E04	ML16213E04	-	13.5	4	10	56	8
ML06216E01	ML16216E01	-	16.5	2.5	10	56	8
ML06216E02	ML16216E02	-	16.5	3	10	56	8
ML06216E03	ML16216E03	-	16.5	4	10	56	8
ML06216E04	ML16216E04	-	16.5	5	10	56	8
ML06219E01	ML16219E01	-	19.5	3	10	56	8
ML06219E02	ML16219E02	-	19.5	4	10	63	8
ML06219E03	ML16219E03	-	19.5	5	10	63	8
ML06219E04	ML16219E04	-	19.5	6	10	63	8
ML06222E01	ML16222E01	-	22.5	4	10	63	10
ML06222E02	ML16222E02	▲ ML26222E02	22.5	5	10	63	10
ML06222E03	ML16222E03	-	22.5	6	10	63	10
ML06222E04	ML16222E04	-	22.5	8	10	63	10
ML06225E01	ML16225E01	-	25.5	5	10	63	10

Tolerances according to DIN 7160 & 7161

▲ : Only available till stock runs out

▶ NEXT PAGE

Nominal-Diameter in mm							
	from 1 to 3	over 3 to 6	over 6 to 10	over 10 to 18	over 18 to 30	over 30 to 50	over 50 to 80
Tolerance range in mm							
js18	± 0.90	± 1.10	± 1.35	± 1.65	± 1.95	± 2.30	± 2.70
Tolerance range in μm							
h11	0 -60	0 -75	0 -90	0 -110	0 -130	0 -160	0 -190
e8	-14 -28	-20 -38	-25 -47	-32 -59	-40 -73	-50 -89	-60 -106
h6	0 -6	0 -8	0 -9	0 -11	0 -13	0 -16	0 -19

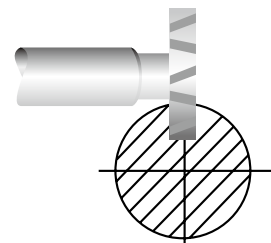

◎ : Excellent ○ : Good

ISO	P											M			K					
	Non-alloy steel					Low alloy steel				High alloyed steel, and tool steel		Stainless steel			Grey cast iron		Nodular cast iron		Malleable cast iron	
Material Description	1	2	3	4	5	6	7	8	9	10	11	12	13	14	15	16	17	18	19	20
VDI 3323																				
HRc																				
HB	125	190	250	270	300	180	275	300	350	200	325	200	240	180	180	260	160	250	130	230
Recommended	◎	◎	◎	◎	◎	◎	◎	◎	◎	◎	◎	◎	◎	◎	◎	◎	◎	◎	◎	◎

ISO	N										S					H					
	Aluminum-wrought alloy		Aluminum-cast, alloyed			Copper and Copper Alloys (Bronze / Brass)			Non Metallic Materials		Heat Resistant Super Alloys					Titanium Alloys		Hardened steel	Chilled Cast Iron	Hardened Cast Iron	
Material Description	21	22	23	24	25	26	27	28	29	30	31	32	33	34	35	36	37	38	39	40	41
VDI 3323																					
HRc																					
HB	60	100	75	90	130	110	90	100			200	280	250	350	320	400 Rm	1050 Rm	550	630	400	550
Recommended	◎	◎	◎	◎	◎	◎	◎	◎	◎	◎	◎	◎	◎	◎	◎	◎	◎	◎	◎	◎	◎

HSS-E, WOODRUFF KEYSEAT CUTTERS TYPE "B", "D", "F"

- HSS-E, SCHLITZFRÄSER FORM "B", "D", "F"
- Fraise HSS-E WOODRUFF Type "B", "D", "F"
- FRESE PER CHIAVETTE WOODRUFF TIPO "B", "D", "F"

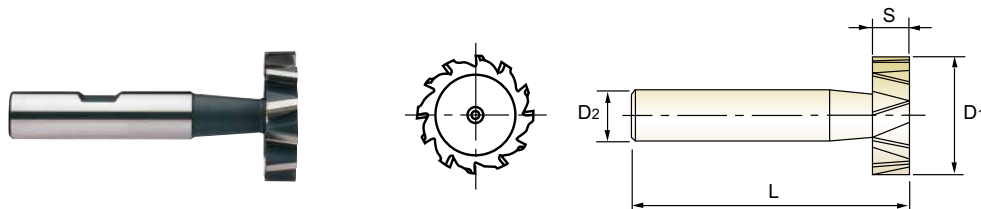

EDP No.		Cutter Diameter	Width of Face	Shank Diameter	Overall Length	No. of Teeth	
PLAIN	FLAT	THREAD	D1(h11)	S(e8)	D2(h6)	L(js18)	Z
ML06225E02	ML16225E02	-	25.5	6	10	63	10
ML06225E03	ML16225E03	-	25.5	7	10	63	10
ML06225E04	ML16225E04	-	25.5	8	10	63	10
ML06228E01	ML16228E01	▲ ML26228E01	28.5	5	10	63	10
ML06228E02	ML16228E02	-	28.5	6	10	63	10
ML06228E03	ML16228E03	-	28.5	7	10	63	10
ML06228E04	ML16228E04	-	28.5	8	10	63	10
ML06228E05	ML16228E05	▲ ML26228E05	28.5	10	12	71	10
ML06232E01	ML16232E01	-	32.5	5	12	71	12
ML06232E02	ML16232E02	-	32.5	6	12	71	12
ML06232E03	ML16232E03	▲ ML26232E03	32.5	7	12	71	12
ML06232E04	ML16232E04	-	32.5	8	12	71	12
ML06232E05	ML16232E05	▲ ML26232E05	32.5	10	12	71	12
ML06238E01	ML16238E01	-	38.5	7	12	71	12
ML06238E02	ML16238E02	-	38.5	8	12	71	12
ML06238E03	ML16238E03	-	38.5	9	12	71	12
ML06238E04	ML16238E04	-	38.5	10	12	71	12
ML06245E01	ML16245E01	-	45.5	10	12	71	14

▲ : Only available till stock runs out

Tolerances according to DIN 7160 & 7161

	Nominal-Diameter in mm						
	from 1 to 3	over 3 to 6	over 6 to 10	over 10 to 18	over 18 to 30	over 30 to 50	over 50 to 80
Tolerance range in mm							
js18	± 0.90	± 1.10	± 1.35	± 1.65	± 1.95	± 2.30	± 2.70
Tolerance range in μm							
h11	0 -60	0 -75	0 -90	0 -110	0 -130	0 -160	0 -190
e8	-14 -28	-20 -38	-25 -47	-32 -59	-40 -73	-50 -89	-60 -106
h6	0 -6	0 -8	0 -9	0 -11	0 -13	0 -16	0 -19

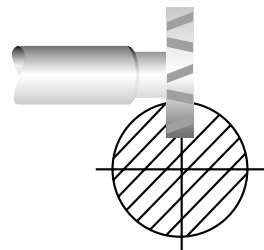

◎ : Excellent ○ : Good

ISO Material Description	P										M			K							
	Non-alloy steel					Low alloy steel					High alloyed steel, and tool steel			Stainless steel			Grey cast iron		Nodular cast iron		Malleable cast iron
VDI 3323	1	2	3	4	5	6	7	8	9	10	11	12	13	14	15	16	17	18	19	20	
HRc		13	25	28	32	10	29	32	38	15	35	15	23	10	10	26	3	25		21	
HB	125	190	250	270	300	180	275	300	350	200	325	200	240	180	180	260	160	250	130	230	
Recommended	◎	◎	◎	◎	◎	◎	◎	◎	◎	◎	◎										
ISO Material Description	N					S					H										
	Aluminum-wrought alloy		Aluminum-cast, alloyed			Copper and Copper Alloys (Bronze / Brass)			Non Metallic Materials		Heat Resistant Super Alloys			Titanium Alloys		Hardened steel	Chilled Cast Iron	Hardened Cast Iron			
VDI 3323	21	22	23	24	25	26	27	28	29	30	31	32	33	34	35	36	37	38	39	40	41
HRc											15	30	25	38	34	55	60	42	55		
HB	60	100	75	90	130	110	90	100			200	280	250	350	320	400 Rm	1050 Rm	550	630	400	550
Recommended	◎	◎	◎	◎	◎																



PLAIN SHANK

ML072 SERIES

FLAT SHANK

ML172 SERIES

THREAD SHANK

ML272 SERIES

HSS-E, T-SLOT CUTTERS TYPE "AA", "AB", "AD"

- HSS-E, SCHAFTERFRÄSER FÜR T-NUTEN FORM "AA", "AB", "AD"
- Fraise HSS-E pour rainure en "T" Type "AA", "AB", "AD"
- FRESE PER SCANALATURE A T - DENTI ALTERNATI

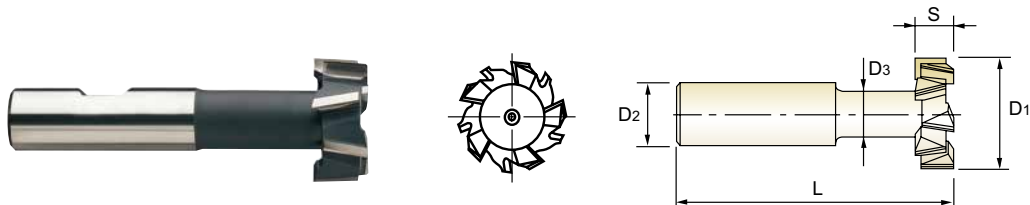

Unit : mm

EDP No.			Cutter Diameter	Width of Face	Shank Diameter	Neck Diameter	Overall Length	No. of Teeth
PLAIN	FLAT	THREAD	D1(d11)	S(d11)	D2(h6)	D3(h12)	L(js18)	Z
ML07212E01	ML17212E01	-	12.5	6	10	5	57	6
ML07201601	ML17201601	-	16.0	8	10	6.5	62	6
ML07201801	ML17201801	-	18.0	8	12	8	70	6
ML07201901	ML17201901	-	19.0	9	12	8	71	6
ML07202101	ML17202101	-	21.0	9	12	10	74	6
ML07202201	ML17202201	-	22.0	10	12	10	75	6
ML07202501	ML17202501	-	25.0	11	16	12	82	6
ML07202801	ML17202801	▲ ML27202801	28.0	12	16	13	83	6
ML07203201	ML17203201	-	32.0	14	16	15	90	8
ML07203601	ML17203601	▲ ML27203601	36.0	16	25	17	103	8
ML07204001	ML17204001	▲ ML27204001	40.0	18	25	19	108	8

▲ : Only available till stock runs out

Tolerances according to DIN 7160 & 7161

	Nominal-Diameter in mm						
	over3 to6	over6 to10	over10 to18	over18 to30	over30 to50	over50 to80	over80 to120
Tolerance range in mm							
h12	0	0	0	0	0	0	0
	-0.12	-0.15	-0.18	-0.21	-0.25	-0.30	-0.35
js18	±0.90	±1.10	±1.35	±1.65	±1.95	±2.30	±2.70
Tolerance range in µm							
d11	-30	-40	-50	-65	-80	-100	-120
	-105	-130	-160	-195	-240	-290	-340
h6	0	0	0	0	0	0	0
	-8	-9	-11	-13	-16	-19	-22

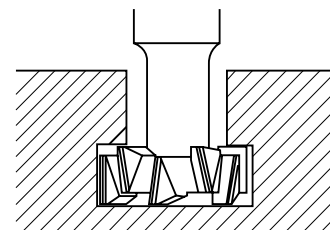

◎ : Excellent ○ : Good

ISO	P										M			K							
	Non-alloy steel					Low alloy steel					High alloyed steel, and tool steel			Stainless steel			Grey cast iron		Nodular cast iron		Malleable cast iron
Material Description	1	2	3	4	5	6	7	8	9	10	11	12	13	14	15	16	17	18	19	20	
VDI 3323																					
HRc	13	25	28	32	10	29	32	38	15	35	15	23	10	10	26	3	25	42	21		
HB	125	190	250	270	300	180	275	300	350	200	325	200	240	180	180	260	160	250	130	230	
Recommended	◎	◎	◎	◎	◎	◎	◎	◎	◎	◎	◎	◎	◎	◎	◎	◎	◎	◎	◎	◎	
ISO	N										S							H			
	Aluminum-wrought alloy		Aluminum-cast, alloyed			Copper and Copper Alloys (Bronze / Brass)			Non Metallic Materials		Heat Resistant Super Alloys					Titanium Alloys		Hardened steel	Chilled Cast Iron	Hardened Cast Iron	
Material Description	21	22	23	24	25	26	27	28	29	30	31	32	33	34	35	36	37	38	39	40	41
VDI 3323																					
HRc	60	100	75	90	130	110	90	100			15	30	25	38	34			55	60	42	55
HB	60	100	75	90	130	110	90	100			200	280	250	350	320	400 Rm	1050 Rm	550	630	400	550
Recommended	◎	◎	◎	◎	◎	◎	◎	◎	◎	◎	◎	◎	◎	◎	◎	◎	◎	◎	◎	◎	◎

HSS-E, SIDE AND FACE MILLING CUTTERS with STRAIGHT TEETH

- HSS-E, SCHEIBENFRÄSER mit GERADEVERZAHNT
- Fraise HSS-E 3 Tailles, denture droite
- FRESE A DISCO A TRE TAGLI - DENTI DRITTI

▶ The tools are used for general purpose side and straddle milling where deep cut is not required.

▶ Diese Werkzeuge werden bei allgemeinen Seiten- und Breitfräsen eingesetzt, wo Tiefschnitte nicht vorkommen.

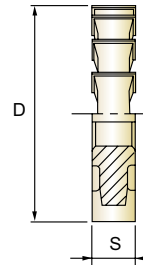
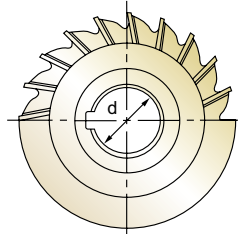

HSS-E
DIN 885-B
H
P.816

Unit : mm

EDP No.	Cutter Diameter	Width of Face	Internal Diameter	No. of Teeth
	D ₁ (js14)	S(k11)	d(H7)	Z
ML09205001	50.0	4	16	18
ML09205002	50.0	5	16	18
ML09205003	50.0	6	16	18
ML09205004	50.0	8	16	16
ML09205005	50.0	10	16	16
ML09206301	63.0	5	22	22
ML09206302	63.0	6	22	22
ML09206303	63.0	8	22	20
ML09206304	63.0	10	22	20
ML09206305	63.0	12	22	20
ML09208001	80.0	6	22	24
ML09208002	80.0	8	22	24
ML09208003	80.0	10	22	24
ML09208004	80.0	12	22	20
ML09208005	80.0	6	27	24
ML09208006	80.0	8	27	24
ML09208007	80.0	10	27	24
ML09208008	80.0	12	27	20
ML09210001	100.0	6	27	26
ML09210002	100.0	8	27	26

▶ NEXT PAGE

Tolerances according to DIN 7160 & 7161

Nominal-Diameter in mm								
	over 3 to 6	over 6 to 10	over 10 to 18	over 18 to 30	over 30 to 50	over 50 to 80	over 80 to 120	over 120 to 180
Tolerance range in mm								
js14	± 0.15	± 0.18	± 0.215	± 0.26	± 0.31	± 0.37	± 0.435	± 0.50
Tolerance range in μm								
k11	+75 0	+90 0	+110 0	+130 0	+160 0	+190 0	+220 0	+250 0
H7	+12 0	+15 0	+18 0	+21 0	+25 0	+30 0	+35 0	+40 0

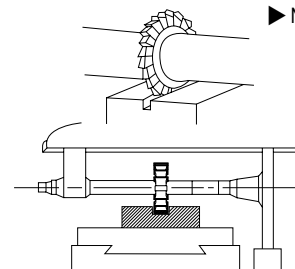

◎ : Excellent ○ : Good

ISO Material Description	P										M			K						
	Non-alloy steel					Low alloy steel					High alloyed steel, and tool steel			Stainless steel			Grey cast iron		Nodular cast iron	
VDI 3323	1	2	3	4	5	6	7	8	9	10	11	12	13	14	15	16	17	18	19	20
HRC	13	25	28	32	10	29	32	38	15	35	15	23	10	10	26	3	25	42	21	
HB	125	190	250	270	300	180	275	300	350	200	325	200	240	180	180	260	160	250	130	230
Recommended	◎	◎	◎	◎	◎	◎	◎	◎	◎	◎	◎	◎	◎	◎	◎	◎	◎	◎	◎	◎

ISO Material Description	N					S					H										
	Aluminum-wrought alloy		Aluminum-cast, alloyed			Copper and Copper Alloys (Bronze / Brass)			Non Metallic Materials		Heat Resistant Super Alloys					Titanium Alloys		Hardened steel	Chilled Cast Iron	Hardened Cast Iron	
VDI 3323	21	22	23	24	25	26	27	28	29	30	31	32	33	34	35	36	37	38	39	40	41
HRC	60	100	75	90	130	110	90	100			15	30	25	38	34	55	60	55	60	42	55
HB	60	100	75	90	130	110	90	100			200	280	250	350	320	400 Rm	1050 Rm	550	630	400	550
Recommended	◎	◎	◎	◎	◎	◎	◎	◎	◎	◎	◎	◎	◎	◎	◎	◎	◎	◎	◎	◎	◎

HSS-E, SIDE AND FACE MILLING CUTTERS with STRAIGHT TEETH

● HSS-E, SCHEIBENFRÄSER mit GERADEVERZÄHNT

● Fraise HSS-E 3 Tailles, denture droite

● FRESE A DISCO A TRE TAGLI - DENTI DRITTI

▶ The tools are used for general purpose side and straddle milling where deep cut is not required.

▶ Diese Werkzeuge werden bei allgemeinen Seiten- und Breitfräsen eingesetzt, wo Tiefschnitte nicht vorkommen.

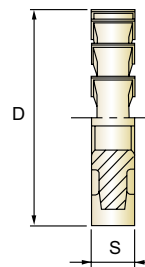
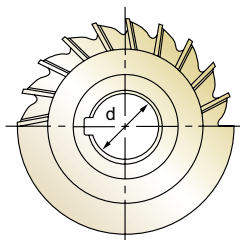

Unit : mm

EDP No.	Cutter Diameter	Width of Face	Internal Diameter	No. of Teeth
	D1(js14)	S(k11)	d(H7)	Z
ML09210003	100.0	10	27	22
ML09210004	100.0	6	32	26
ML09210005	100.0	8	32	26
ML09210006	100.0	10	32	22
ML09210007	100.0	12	32	22
ML09212501	125.0	8	32	30
ML09212502	125.0	10	32	30
ML09212503	125.0	12	32	24

Tolerances according to DIN 7160 & 7161

Nominal-Diameter in mm								
	over3 to 6	over 6 to 10	over 10 to 18	over 18 to 30	over 30 to 50	over 50 to 80	over 80 to 120	over 120 to 180
Tolerance range in mm								
js14	± 0.15	± 0.18	± 0.215	± 0.26	± 0.31	± 0.37	± 0.435	± 0.50
Tolerance range in μm								
k11	+75 0	+90 0	+110 0	+130 0	+160 0	+190 0	+220 0	+250 0
H7	+12 0	+15 0	+18 0	+21 0	+25 0	+30 0	+35 0	+40 0

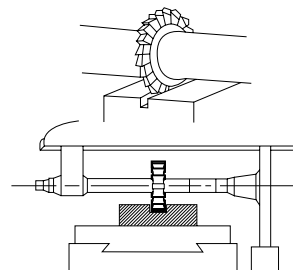

◎ : Excellent ○ : Good

ISO	P											M			K						
	Non-alloy steel					Low alloy steel				High alloyed steel, and tool steel		Stainless steel			Grey cast iron		Nodular cast iron	Malleable cast iron			
VDI 3323	1	2	3	4	5	6	7	8	9	10	11	12	13	14	15	16	17	18	19	20	
HRc	13	25	28	32	10	29	32	38	15	35	15	23	10	10	26	3	25				
HB	125	190	250	270	300	180	275	300	350	200	325	200	240	180	180	260	160	250	130	230	
Recommended	◎	◎	◎	◎	◎	◎	◎	◎	○	◎	○										
ISO	N										S						H				
	Aluminum-wrought alloy		Aluminum-cast, alloyed			Copper and Copper Alloys (Bronze / Brass)			Non Metallic Materials		Heat Resistant Super Alloys						Titanium Alloys		Hardened steel	Chilled Cast Iron	Hardened Cast Iron
VDI 3323	21	22	23	24	25	26	27	28	29	30	31	32	33	34	35	36	37	38	39	40	41
HRc											15	30	25	38	34			55	60	42	55
HB	60	100	75	90	130	110	90	100			200	280	250	350	320	400 Rm	1050 Rm	550	630	400	550
Recommended	○	○	○	○	○																

HSS-E, SIDE AND FACE MILLING CUTTERS with STAGGERED TEETH

- HSS-E, SCHEIBENFRÄSER mit KREUZVERZAHNT
- Fraise HSS-E 3 Tailles, denture alternée
- FRESE A DISCO A TRE TAGLI - DENTI ALTERNATI

▶ The type of cutter is recommended for slotting operations.
The alternate spiral effectively counteracts all tendency to chatter.

▶ Dieser Typ ist zum Schlitzfräsen geeignet. Das alternierende Spiral wirkt allen Schnatterbewegungen entgegen.

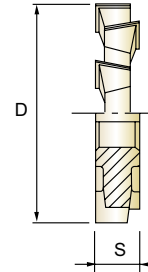
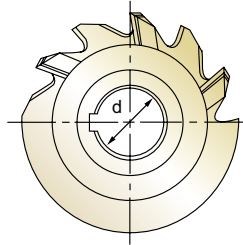

HSS-E
DIN 885-A
H
P.817

Unit : mm

EDP No.	Cutter Diameter	Width of Face	Internal Diameter	No. of Teeth
	D(js14)	S(k11)	d(H7)	Z
ML10205001	50.0	3	16	14
ML10205002	50.0	4	16	14
ML10205003	50.0	5	16	14
ML10205004	50.0	6	16	14
ML10205005	50.0	7	16	14
ML10205006	50.0	8	16	14
ML10205007	50.0	9	16	14
ML10205008	50.0	10	16	14
ML10206301	63.0	3	22	16
ML10206302	63.0	4	22	16
ML10206303	63.0	5	22	16
ML10206304	63.0	6	22	16
ML10206305	63.0	7	22	16
ML10206306	63.0	8	22	16
ML10206307	63.0	9	22	16
ML10206308	63.0	10	22	16
ML10206309	63.0	12	22	16
ML10206310	63.0	14	22	16
ML10206311	63.0	16	22	16
ML10206312	63.0	18	22	16

Tolerances according to DIN 7160 & 7161

	Nominal-Diameter in mm								
	over 3 to 6	over 6 to 10	over 10 to 18	over 18 to 30	over 30 to 50	over 50 to 80	over 80 to 120	over 120 to 180	over 180 to 250
Tolerance range in mm									
js14	± 0.15	± 0.18	± 0.215	± 0.26	± 0.31	± 0.37	± 0.435	± 0.50	± 0.575
Tolerance range in μm									
k11	+75 0	+90 0	+110 0	+130 0	+160 0	+190 0	+220 0	+250 0	+290 0
H7	+12 0	+15 0	+18 0	+21 0	+25 0	+30 0	+35 0	+40 0	+46 0

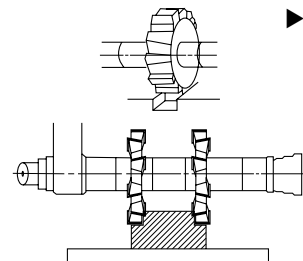

▶ NEXT PAGE

◎ : Excellent ○ : Good

ISO Material Description	P										M				K							
	Non-alloy steel					Low alloy steel					High alloyed steel, and tool steel				Stainless steel			Grey cast iron		Nodular cast iron		Malleable cast iron
VDI 3323	1	2	3	4	5	6	7	8	9	10	11	12	13	14	15	16	17	18	19	20		
HRC	13	25	28	32	10	29	32	38	15	35	15	23	10	10	26	3	25	42	21			
HB	125	190	250	270	300	180	275	300	350	200	325	200	240	180	180	260	160	250	130	230		
Recommended	◎	◎	◎	◎	◎	◎	◎	◎	○	◎	◎	◎	◎	◎	◎	◎	◎	◎	◎			

ISO Material Description	N					S					H											
	Aluminum-wrought alloy		Aluminum-cast, alloyed		Copper and Copper Alloys (Bronze / Brass)	Non Metallic Materials	Heat Resistant Super Alloys			Titanium Alloys		Hardened steel	Chilled Cast Iron	Hardened Cast Iron								
VDI 3323	21	22	23	24	25	26	27	28	29	30	31	32	33	34	35	36	37	38	39	40	41	
HRC	21	22	23	24	25	26	27	28	29	30	31	32	33	34	35	36	37	38	39	40	41	
HB	60	100	75	90	130	110	90	100				200	280	250	350	320	400 Rm	1050 Rm	550	630	400	550
Recommended	◎	◎	◎	◎	◎	◎	◎	◎	◎	◎	◎	◎	◎	◎	◎	◎	◎	◎	◎	◎	◎	

HSS-E, SIDE AND FACE MILLING CUTTERS with STAGGERED TEETH

- HSS-E, SCHEIBENFRÄSER mit KREUZVERZAHNT
- Fraise HSS-E 3 Tailles, denture alternée
- FRESE A DISCO A TRE TAGLI - DENTI ALTERNATI

▶ The type of cutter is recommended for slotting operations.
The alternate spiral effectively counteracts all tendency to chatter.

▶ Dieser Typ ist zum Schlitzfräsen geeignet. Das alternierende Spiral wirkt allen Schnatterbewegungen entgegen.

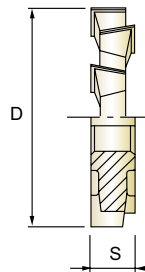
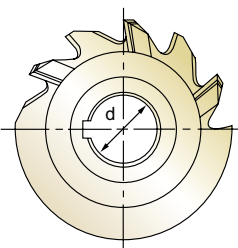

HSS-E
DIN 885-A
H
P.817

Unit : mm

EDP No.	Cutter Diameter	Width of Face	Internal Diameter	No. of Teeth
	D(js14)	S(k11)	d(H7)	Z
ML10208001	80.0	3	22	18
ML10208002	80.0	4	22	18
ML10208003	80.0	5	22	18
ML10208004	80.0	6	22	18
ML10208005	80.0	7	22	18
ML10208006	80.0	8	22	18
ML10208007	80.0	9	22	18
ML10208008	80.0	10	22	18
ML10208009	80.0	12	22	18
ML10208010	80.0	14	22	18
ML10208011	80.0	16	22	18
ML10208012	80.0	18	22	18
ML10208013	80.0	20	22	18
ML10208014	80.0	4	27	18
ML10208015	80.0	5	27	18
ML10208016	80.0	6	27	18
ML10208017	80.0	7	27	18
ML10208018	80.0	8	27	18
ML10208019	80.0	9	27	18
ML10208020	80.0	10	27	18

Tolerances according to DIN 7160 & 7161

	Nominal-Diameter in mm								
	over 3 to 6	over 6 to 10	over 10 to 18	over 18 to 30	over 30 to 50	over 50 to 80	over 80 to 120	over 120 to 180	over 180 to 250
Tolerance range in mm									
js14	± 0.15	± 0.18	± 0.215	± 0.26	± 0.31	± 0.37	± 0.435	± 0.50	± 0.575
Tolerance range in μm									
k11	+75 0	+90 0	+110 0	+130 0	+160 0	+190 0	+220 0	+250 0	+290 0
H7	+12 0	+15 0	+18 0	+21 0	+25 0	+30 0	+35 0	+40 0	+46 0

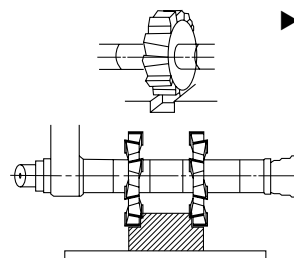

▶ NEXT PAGE

◎ : Excellent ○ : Good

ISO Material Description	P											M			K						
	Non-alloy steel					Low alloy steel				High alloyed steel, and tool steel		Stainless steel			Grey cast iron		Nodular cast iron		Malleable cast iron		
VDI 3323	1	2	3	4	5	6	7	8	9	10	11	12	13	14	15	16	17	18	19	20	
HRc		13	25	28	32	10	29	32	38	15	35	15	23	10	10	26	3	25		21	
HB	125	190	250	270	300	180	275	300	350	200	325	200	240	180	180	260	160	250	130	230	
Recommended	◎	◎	◎	◎	◎	◎	◎	◎	◎	◎	◎	◎	◎	◎	◎	◎	◎	◎	◎	◎	
ISO Material Description	N										S					H					
	Aluminum-wrought alloy		Aluminum-cast, alloyed			Copper and Copper Alloys (Bronze / Brass)			Non Metallic Materials		Heat Resistant Super Alloys					Titanium Alloys		Hardened steel	Chilled Cast Iron	Hardened Cast Iron	
VDI 3323	21	22	23	24	25	26	27	28	29	30	31	32	33	34	35	36	37	38	39	40	41
HRc											15	30	25	38	34			55	60	42	55
HB	60	100	75	90	130	110	90	100			200	280	250	350	320	400 Rm	1050 Rm	550	630	400	550
Recommended	◎	◎	◎	◎	◎	◎	◎	◎	◎	◎	◎	◎	◎	◎	◎	◎	◎	◎	◎	◎	◎

HSS-E, SIDE AND FACE MILLING CUTTERS with STAGGERED TEETH

- HSS-E, SCHEIBENFRÄSER mit KREUZVERZAHNT
- Fraise HSS-E 3 Tailles, denture alternée
- FRESE A DISCO A TRE TAGLI - DENTI ALTERNATI

▶ The type of cutter is recommended for slotting operations.
The alternate spiral effectively counteracts all tendency to chatter.

▶ Dieser Typ ist zum Schlitzfräsen geeignet. Das alternierende Spiral wirkt allen Schnatterbewegungen entgegen.

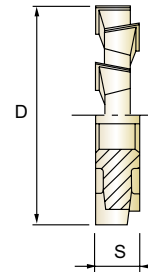
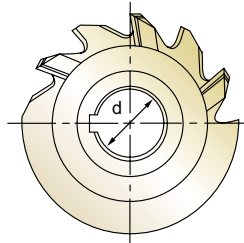

EDP No.	Cutter Diameter	Width of Face	Internal Diameter	No. of Teeth
	D(js14)	S(k11)	d(H7)	Z
ML10208021	80.0	12	27	18
ML10208022	80.0	14	27	18
ML10208023	80.0	16	27	18
ML10208024	80.0	18	27	18
ML10208025	80.0	20	27	18
ML10210001	100.0	3	27	20
ML10210002	100.0	4	27	20
ML10210003	100.0	5	27	20
ML10210004	100.0	6	27	20
ML10210005	100.0	7	27	20
ML10210006	100.0	8	27	20
ML10210007	100.0	9	27	20
ML10210008	100.0	10	27	20
ML10210009	100.0	12	27	20
ML10210010	100.0	14	27	20
ML10210011	100.0	15	27	20
ML10210012	100.0	16	27	20
ML10210013	100.0	18	27	20
ML10210014	100.0	20	27	20
ML10210015	100.0	4	32	20

Unit : mm

Tolerances according to DIN 7160 & 7161

	Nominal-Diameter in mm								
	over 3 to 6	over 6 to 10	over 10 to 18	over 18 to 30	over 30 to 50	over 50 to 80	over 80 to 120	over 120 to 180	over 180 to 250
	Tolerance range in mm								
js14	± 0.15	± 0.18	± 0.215	± 0.26	± 0.31	± 0.37	± 0.435	± 0.50	± 0.575
	Tolerance range in μm								
k11	+75 0	+90 0	+110 0	+130 0	+160 0	+190 0	+220 0	+250 0	+290 0
H7	+12 0	+15 0	+18 0	+21 0	+25 0	+30 0	+35 0	+40 0	+46 0

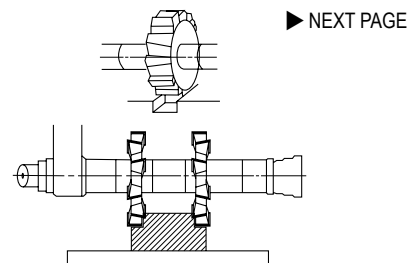

◎ : Excellent ○ : Good

ISO Material Description	P										M				K								
	Non-alloy steel					Low alloy steel					High alloyed steel, and tool steel				Stainless steel				Grey cast iron		Nodular cast iron		Malleable cast iron
VDI 3323	1	2	3	4	5	6	7	8	9	10	11	12	13	14	15	16	17	18	19	20			
HRC	13	25	28	32	10	29	32	38	15	35	15	23	10	10	26	3	25	42	21				
HB	125	190	250	270	300	180	275	300	350	200	325	200	240	180	180	260	160	250	130	230			
Recommended	◎	◎	◎	◎	◎	◎	◎	◎	○	◎	○	◎	◎	◎	◎	◎	◎	◎	◎	◎			

ISO Material Description	N					S					H										
	Aluminum-wrought alloy		Aluminum-cast, alloyed			Copper and Copper Alloys (Bronze / Brass)			Non Metallic Materials		Heat Resistant Super Alloys			Titanium Alloys		Hardened steel	Chilled Cast Iron	Hardened Cast Iron			
VDI 3323	21	22	23	24	25	26	27	28	29	30	31	32	33	34	35	36	37	38	39	40	41
HRC	60	100	75	90	130	110	90	100			15	30	25	38	34	55	60	42	55		
HB	60	100	75	90	130	110	90	100			200	280	250	350	320	400 Rm	1050 Rm	550	630	400	550
Recommended	◎	◎	◎	◎	◎	◎	◎	◎	◎	◎	◎	◎	◎	◎	◎	◎	◎	◎	◎	◎	◎

HSS-E, SIDE AND FACE MILLING CUTTERS with STAGGERED TEETH

- HSS-E, SCHEIBENFRÄSER mit KREUZVERZAHNT
- Fraise HSS-E 3 Tailles, denture alternée
- FRESE A DISCO A TRE TAGLI - DENTI ALTERNATI

▶ The type of cutter is recommended for slotting operations. The alternate spiral effectively counteracts all tendency to chatter. ▶ Dieser Typ ist zum Schlitzfräsen geeignet. Das alternierende Spiral wirkt allen Schnatterbewegungen entgegen.

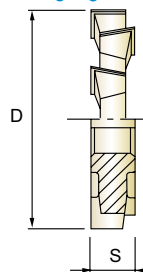
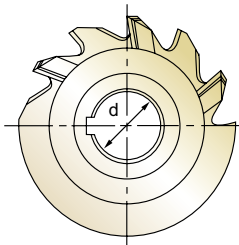

HSS-E
DIN 885-A
H
P.817

Unit : mm

EDP No.	Cutter Diameter	Width of Face	Internal Diameter	No. of Teeth
	D(js14)	S(k11)	d(H7)	Z
ML10210016	100.0	5	32	20
ML10210017	100.0	6	32	20
ML10210018	100.0	7	32	20
ML10210019	100.0	8	32	20
ML10210020	100.0	9	32	20
ML10210021	100.0	10	32	20
ML10210022	100.0	12	32	20
ML10210023	100.0	14	32	20
ML10210024	100.0	15	32	20
ML10210025	100.0	16	32	20
ML10210026	100.0	18	32	20
ML10210027	100.0	20	32	20
ML10212501	125.0	5	32	22
ML10212502	125.0	6	32	22
ML10212503	125.0	8	32	22
ML10212504	125.0	10	32	22
ML10212505	125.0	12	32	22
ML10212506	125.0	14	32	22
ML10212507	125.0	16	32	22
ML10212508	125.0	18	32	22

Tolerances according to DIN 7160 & 7161

	Nominal-Diameter in mm								
	over3 to6	over6 to10	over10 to18	over18 to30	over30 to50	over50 to80	over80 to120	over120 to180	over180 to250
Tolerance range in mm									
js14	± 0.15	± 0.18	± 0.215	± 0.26	± 0.31	± 0.37	± 0.435	± 0.50	± 0.575
Tolerance range in µm									
k11	+75 0	+90 0	+110 0	+130 0	+160 0	+190 0	+220 0	+250 0	+290 0
H7	+12 0	+15 0	+18 0	+21 0	+25 0	+30 0	+35 0	+40 0	+46 0

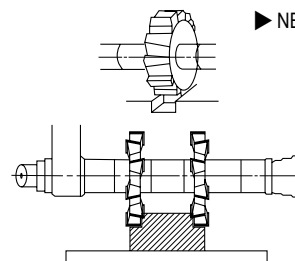

▶ NEXT PAGE

◎ : Excellent ○ : Good

ISO Material Description	P										M				K																						
	Non-alloy steel					Low alloy steel					High alloyed steel, and tool steel				Stainless steel				Grey cast iron		Nodular cast iron		Malleable cast iron														
VDI 3323	1	2	3	4	5	6	7	8	9	10	11	12	13	14	15	16	17	18	19	20	15	16	17	18	19	20	3	3	3	3	3	3	3	3	3	3	
HRc	125	13	25	28	32	10	29	32	38	15	35	15	23	10	10	26	160	250	130	230	180	260	160	250	130	230	55	60	42	55	55	60	42	55	55	60	
HB	60	100	75	90	130	110	90	100		31	32	33	34	35	36	37	38	39	40	41	400 Rm	1050 Rm	550	630	400	550	200	280	250	350	320	400 Rm	1050 Rm	550	630	400	550
Recommended	◎	◎	◎	◎	◎	◎	◎	◎	◎	◎	◎	◎	◎	◎	◎	◎	◎	◎	◎	◎	◎	◎	◎	◎	◎	◎	◎	◎	◎	◎	◎	◎	◎	◎	◎	◎	

HSS-E, SIDE AND FACE MILLING CUTTERS with STAGGERED TEETH

- HSS-E, SCHEIBENFRÄSER mit KREUZVERZÄHNT
- Fraise HSS-E 3 Tailles, denture alternée
- FRESE A DISCO A TRE TAGLI - DENTI ALTERNATI

▶ The type of cutter is recommended for slotting operations.
The alternate spiral effectively counteracts all tendency to chatter.

▶ Dieser Typ ist zum Schlitzfräsen geeignet. Das alternierende Spiral wirkt allen Schnatterbewegungen entgegen.

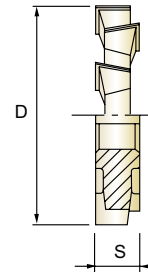
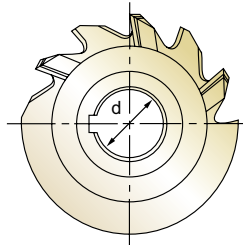

Unit : mm

EDP No.	Cutter Diameter	Width of Face	Internal Diameter	No. of Teeth
	D(js14)	S(k11)	d(H7)	Z
ML10212509	125.0	20	32	22
ML10216001	160.0	6	32	26
ML10216002	160.0	8	32	26
ML10216003	160.0	10	32	26
ML10216004	160.0	12	32	26
ML10216005	160.0	14	32	26
ML10216006	160.0	16	32	26
ML10216007	160.0	18	32	26
ML10216008	160.0	20	32	26
ML10216009	160.0	6	40	26
ML10216010	160.0	8	40	26
ML10216011	160.0	10	40	26
ML10216012	160.0	12	40	26
ML10216013	160.0	14	40	26
ML10216014	160.0	16	40	26
ML10216015	160.0	18	40	26
ML10216016	160.0	20	40	26
ML10220001	200.0	10	40	30
ML10220002	200.0	12	40	30
ML10220003	200.0	14	40	30

Tolerances according to DIN 7160 & 7161

		Nominal-Diameter in mm								
		over 3 to 6	over 6 to 10	over 10 to 18	over 18 to 30	over 30 to 50	over 50 to 80	over 80 to 120	over 120 to 180	over 180 to 250
		Tolerance range in mm								
js14		± 0.15	± 0.18	± 0.215	± 0.26	± 0.31	± 0.37	± 0.435	± 0.50	± 0.575
		Tolerance range in μ m								
k11		+75 0	+90 0	+110 0	+130 0	+160 0	+190 0	+220 0	+250 0	+290 0
H7		+12 0	+15 0	+18 0	+21 0	+25 0	+30 0	+35 0	+40 0	+46 0

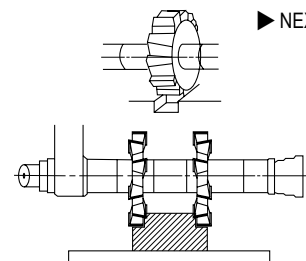

▶ NEXT PAGE

◎ : Excellent ○ : Good

ISO Material Description	P										M				K							
	Non-alloy steel					Low alloy steel					High alloyed steel, and tool steel				Stainless steel			Grey cast iron		Nodular cast iron		Malleable cast iron
VDI 3323	1	2	3	4	5	6	7	8	9	10	11	12	13	14	15	16	17	18	19	20		
HRC	13	25	28	32	10	29	32	38	15	35	15	23	10	10	26	3	25	42	21			
HB	125	190	250	270	300	180	275	300	350	200	325	200	240	180	180	260	160	250	130	230		
Recommended	◎	◎	◎	◎	◎	◎	◎	◎	○	◎	○											

ISO Material Description	N					S					H										
	Aluminum-wrought alloy		Aluminum-cast, alloyed			Copper and Copper Alloys (Bronze / Brass)		Non Metallic Materials			Heat Resistant Super Alloys					Titanium Alloys		Hardened steel	Chilled Cast Iron	Hardened Cast Iron	
VDI 3323	21	22	23	24	25	26	27	28	29	30	31	32	33	34	35	36	37	38	39	40	41
HRC											15	30	25	38	34			55	60	42	55
HB	60	100	75	90	130	110	90	100			200	280	250	350	320	400 Rm	1050 Rm	550	630	400	550
Recommended	○	○	○	○	○																

HSS-E, SIDE AND FACE MILLING CUTTERS with STAGGERED TEETH

- HSS-E, SCHEIBENFRÄSER mit KREUZVERZAHNT
- Fraise HSS-E 3 Tailles, denture alternée
- FRESE A DISCO A TRE TAGLI - DENTI ALTERNATI

▶ The type of cutter is recommended for slotting operations.
The alternate spiral effectively counteracts all tendency to chatter.

▶ Dieser Typ ist zum Schlitzfräsen geeignet. Das alternierende Spiral wirkt allen Schnatterbewegungen entgegen.

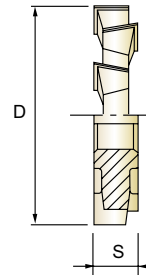
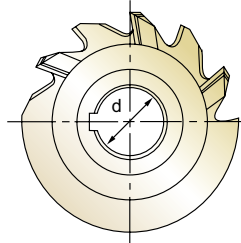

Unit : mm

EDP No.	Cutter Diameter	Width of Face	Internal Diameter	No. of Teeth
	D(js14)	S(k11)	d(H7)	Z
ML10220004	200.0	16	40	30
ML10220005	200.0	18	40	30
ML10220006	200.0	20	40	30
ML10220007	200.0	22	40	30
ML10220008	200.0	25	40	30

Tolerances according to DIN 7160 & 7161

Nominal-Diameter in mm									
	over 3 to 6	over 6 to 10	over 10 to 18	over 18 to 30	over 30 to 50	over 50 to 80	over 80 to 120	over 120 to 180	over 180 to 250
Tolerance range in mm									
js14	± 0.15	± 0.18	± 0.215	± 0.26	± 0.31	± 0.37	± 0.435	± 0.50	± 0.575
Tolerance range in μm									
k11	+75 0	+90 0	+110 0	+130 0	+160 0	+190 0	+220 0	+250 0	+290 0
H7	+12 0	+15 0	+18 0	+21 0	+25 0	+30 0	+35 0	+40 0	+46 0

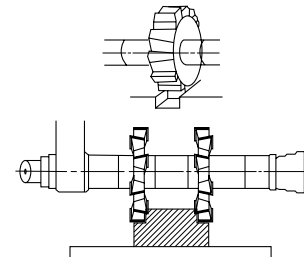

◎ : Excellent ○ : Good

ISO Material Description	P											M			K						
	Non-alloy steel					Low alloy steel				High alloyed steel, and tool steel		Stainless steel			Grey cast iron		Nodular cast iron	Malleable cast iron			
VDI 3323	1	2	3	4	5	6	7	8	9	10	11	12	13	14	15	16	17	18	19	20	
HRc	13	25	28	32	10	29	32	38	15	35	15	23	10	10	26	3	25				
HB	125	190	250	270	300	180	275	300	350	200	325	200	240	180	180	260	160	250	130	230	
Recommended	◎	◎	◎	◎	◎	◎	◎	◎	○	◎	○										
ISO Material Description	N										S						H				
	Aluminum-wrought alloy		Aluminum-cast, alloyed			Copper and Copper Alloys (Bronze / Brass)			Non Metallic Materials		Heat Resistant Super Alloys						Titanium Alloys		Hardened steel	Chilled Cast Iron	Hardened Cast Iron
VDI 3323	21	22	23	24	25	26	27	28	29	30	31	32	33	34	35	36	37	38	39	40	41
HRc											15	30	25	38	34			55	60	42	55
HB	60	100	75	90	130	110	90	100			200	280	250	350	320	400 Rm	1050 Rm	550	630	400	550
Recommended	○	○	○	○	○																

HSSCo8, MULTI FLUTE SHELL END MILL

- HSSCo8, MULTI SCHNEIDEN WALZENSTIRNFRÄSER
- Fraise HSSCo8, multi-dents trou lisse
- FRESA CILINDRICA FRONTALE, MULTI TAGLIENTE

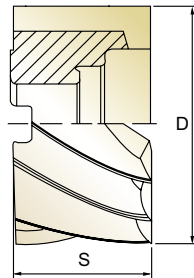
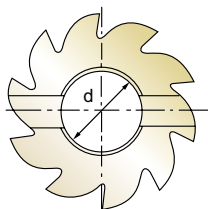
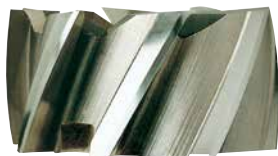

HSS Co8
DIN 841
N
6-10
30°
P.818

Unit : mm

EDP No.	Mill Diameter	Width of Face	Internal Diameter	No. of Teeth
	D	S	d	Z
E2675300	30.0	30	● 13	6
E2675350	35.0	35	● 16	6
E2675400	40.0	20	● 16	8
E2675402	40.0	40	● 16	8
E2675500	50.0	25	22	8
E2675502	50.0	50	22	8
E2675600	60.0	30	27	8
E2675601	60.0	60	27	8
E2675750	75.0	35	27	10
E2675751	75.0	75	27	10
E2675900	90.0	35	27	10
E2675902	110.0	35	32	10

- Tolerance of Internal Diameter = +0.018 ~ 0
- ▶ TIN-COATING, TiCN-COATING & TiAIN-COATING is available on your request.

HSS Co8
DIN 1880
N
8-14
30°
P.818

Unit : mm

EDP No.	Mill Diameter	Width of Face	Internal Diameter	No. of Teeth
	D	S	d	Z
E2675401	40.0	32	● 16	8
E2675501	50.0	36	22	8
E2675630	63.0	40	27	8
E2675800	80.0	45	27	10
E2675901	100.0	50	32	10
E2675903	125.0	56	40	12
E2675904	160.0	63	50	14

- Tolerance of Internal Diameter = +0.018 ~ 0
- ▶ TIN-COATING, TiCN-COATING & TiAIN-COATING is available on your request.

Mill Dia. Tolerance(mm)	Width of Face Tolerance(mm)	Internal Dia. Tolerance(mm)
+ 0.25 - 0.15	+ 0.5 - 0	+ 0.02 - 0

◎ : Excellent ○ : Good

ISO Material Description	P										M			K							
	Non-alloy steel					Low alloy steel					High alloyed steel, and tool steel			Stainless steel			Grey cast iron		Nodular cast iron		Malleable cast iron
VDI 3323	1	2	3	4	5	6	7	8	9	10	11	12	13	14	15	16	17	18	19	20	
HRC	13	25	28	32	10	29	32	38	15	35	15	23	10	10	26	3	25	42	55		
HB	125	190	250	270	300	180	275	300	350	200	325	200	180	180	260	160	250	130	230		
Recommended	◎	◎	◎	◎	◎	◎	◎	◎	○	◎	○	○	○	○	○	○	○	○	○		

ISO Material Description	N					S					H										
	Aluminum-wrought alloy		Aluminum-cast, alloyed			Copper and Copper Alloys (Bronze / Brass)		Non Metallic Materials			Heat Resistant Super Alloys			Titanium Alloys		Hardened steel	Chilled Cast Iron	Hardened Cast Iron			
VDI 3323	21	22	23	24	25	26	27	28	29	30	31	32	33	34	35	36	37	38	39	40	41
HRC	21	22	23	24	25	26	27	28	29	30	31	32	33	34	35	36	37	38	39	40	41
HB	60	100	75	90	130	110	90	100			200	280	250	350	320	400 Rm	1050 Rm	550	630	400	550
Recommended	◎	◎	◎	◎	◎	◎	◎	◎	◎	◎	◎	◎	◎	◎	◎	◎	◎	◎	◎	◎	◎

CBN END MILLS

i-Xmill END MILLS

i-SMART MODULAR END MILLS

X5070 END MILLS

4G MILL END MILLS

X-POWER PRO END MILLS

TitaNox-POWER END MILLS

JET-POWER END MILLS

V7 PLUS END MILLS

ALU-POWER HPC END MILLS

ALU-POWER END MILLS

D-POWER GRAPHITE END MILLS

D-POWER CFRP END MILLS

ROUTERS

CRX S END MILLS

K-2 END MILLS

ONLY ONE COATED PM60 END MILLS

TANK-POWER END MILLS

GENERAL HSS END MILLS

MILLING CUTTERS

TECHNICAL DATA

HSSCo8, MULTI FLUTE SHELL END MILL for ALUMINUM

- HSSCo8, MULTI SCHNEIDEN WALZENSTIRNFRÄSER für ALUMINIUM
- Fraise HSSCo8, multi-dents trou lisse pour aluminium
- FRESA CILINDRICA FRONTALE MULTI TAGLIENTE, PER ALLUMINIO

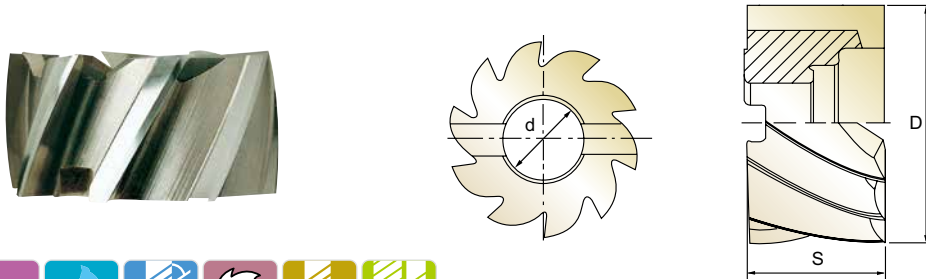

HSS Co8
DIN 841
W
4&6
42°
P.818

Unit : mm

EDP No.	Mill Diameter	Width of Face	Internal Diameter	No. of Teeth
	D	S	d	Z
E2676300	30.0	30	● 13	4
E2676400	40.0	20	● 16	4
E2676402	40.0	40	● 16	4
E2676500	50.0	25	22	6
E2676502	50.0	50	22	6
E2676600	60.0	30	27	6
E2676601	60.0	60	27	6
E2676750	75.0	75	27	6

- Tolerance of Internal Diameter = +0.018 ~ 0
- ▶ TIN-COATING, TiCN-COATING & TiAIN-COATING is available on your request.

HSS Co8
DIN 1880
W
4&6
42°
P.818

Unit : mm

EDP No.	Mill Diameter	Width of Face	Internal Diameter	No. of Teeth
	D	S	d	Z
E2676401	40.0	32	● 16	4
E2676501	50.0	36	22	6
E2676630	63.0	40	27	6
E2676800	80.0	45	27	6
E2676901	100.0	50	32	6

- Tolerance of Internal Diameter = +0.018 ~ 0
- ▶ TIN-COATING, TiCN-COATING & TiAIN-COATING is available on your request.

Mill Dia. Tolerance(mm)	Width of Face Tolerance(mm)	Internal Dia. Tolerance(mm)
+ 0.25	+ 0.5	+ 0.02
- 0.15	- 0	- 0

◎ : Excellent ○ : Good

ISO Material Description	P										M				K								
	Non-alloy steel					Low alloy steel					High alloyed steel, and tool steel				Stainless steel				Grey cast iron		Nodular cast iron		Malleable cast iron
VDI 3323	1	2	3	4	5	6	7	8	9	10	11	12	13	14	15	16	17	18	19	20			
HRc	13	25	28	32	10	29	32	38	15	35	15	23	10	10	26	3	25	42	55				
HB	125	190	250	270	300	180	275	300	350	200	325	200	240	180	180	260	160	250	130	230			
Recommended	○	○	○	○	○	○	○	○	○	○	○	○	○	○	○	○	○	○	○	○	○		

ISO Material Description	N										S							H				
	Aluminum-wrought alloy		Aluminum-cast, alloyed			Copper and Copper Alloys (Bronze / Brass)			Non Metallic Materials		Heat Resistant Super Alloys							Titanium Alloys		Hardened steel	Chilled Cast Iron	Hardened Cast Iron
VDI 3323	21	22	23	24	25	26	27	28	29	30	31	32	33	34	35	36	37	38	39	40	41	
HRc	60	100	75	90	130	110	90	100			15	30	25	38	34	400 Rm	1050 Rm	550	630	400	550	
HB	60	100	75	90	130	110	90	100			200	280	250	350	320	400 Rm	1050 Rm	550	630	400	550	
Recommended	◎	◎	◎	◎	◎																	

HSSCo8, MULTI FLUTE ROUGHING SHELL END MILL - COARSE

- HSSCo8, MULTI SCHNEIDEN WALZENSTIRN-SCHRUPPFÄRÄSER - GROBES
- Fraise HSSCo8, multi-dents trou lisse, ébauche, pas grossier
- FRESA CILINDRICA FRONTALE MULTI TAGLIENTE, PER SGROSSATURA

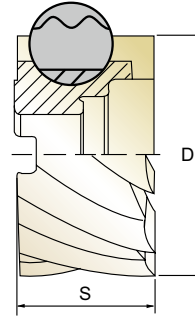
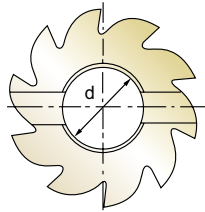

HSS Co8
DIN 841
NR
6-12
30°
P.819

Unit : mm

EDP No.	Mill Diameter	Width of Face	Internal Diameter	No. of Teeth
	D	S	d	Z
E2677401	40.0	40	● 16	6
E2677501	50.0	50	22	8
E2677600	60.0	30	27	8
E2677601	60.0	60	27	8
E2677750	75.0	35	27	10
E2677751	75.0	75	27	10
E2677900	90.0	35	27	10
E2677902	110.0	35	32	12

- Tolerance of Internal Diameter = +0.018 ~ 0
- ▶ TiN-COATING, TiCN-COATING & TiAlN-COATING is available on your request.

HSS Co8
DIN 1880
NR
6-12
30°
P.819

Unit : mm

EDP No.	Mill Diameter	Width of Face	Internal Diameter	No. of Teeth
	D	S	d	Z
E2677400	40.0	32	● 16	6
E2677500	50.0	36	22	8
E2677630	63.0	40	27	8
E2677800	80.0	45	27	10
E2677901	100.0	50	32	10
E2677903	125.0	56	40	12
E2677904	160.0	63	50	12

- Tolerance of Internal Diameter = +0.018 ~ 0
- ▶ TiN-COATING, TiCN-COATING & TiAlN-COATING is available on your request.

Mill Dia. Tolerance(mm)	Width of Face Tolerance(mm)	Internal Dia. Tolerance(mm)
+ 0.25 - 0.15	+ 0.5 - 0	+ 0.02 - 0

◎ : Excellent ○ : Good

ISO Material Description	P											M			K					
	Non-alloy steel					Low alloy steel				High alloyed steel, and tool steel		Stainless steel			Grey cast iron		Nodular cast iron		Malleable cast iron	
VDI 3323	1	2	3	4	5	6	7	8	9	10	11	12	13	14	15	16	17	18	19	20
HRC	13	25	28	32	30	10	29	32	38	15	35	15	23	10	10	26	3	25	42	21
HB	125	190	250	270	300	180	275	300	350	200	325	200	240	180	180	260	160	250	130	230
Recommended	◎	◎	◎	◎	○	◎	◎	○	○	◎	○	◎	◎	◎	◎	◎	◎	◎	◎	◎

ISO Material Description	N					S					H										
	Aluminum-wrought alloy		Aluminum-cast, alloyed		Copper and Copper Alloys (Bronze / Brass)	Non Metallic Materials		Heat Resistant Super Alloys			Titanium Alloys		Hardened steel	Chilled Cast Iron	Hardened Cast Iron						
VDI 3323	21	22	23	24	25	26	27	28	29	30	31	32	33	34	35	36	37	38	39	40	41
HRC	60	100	75	90	130	110	90	100			15	30	25	38	34	55	60	55	60	42	55
HB	60	100	75	90	130	110	90	100			200	280	250	350	320	400 Rm	1050 Rm	550	630	400	550
Recommended	○	○	○	○	○	○	○	○	○	○	○	○	○	○	○	○	○	○	○	○	○

HSSCo8, MULTI FLUTE ROUGHING SHELL END MILL - FINE

- **HSSCo8, MULTI SCHNEIDEN WALZENSTIRN-SCHRUPPFÄRÄSER - FEINES**
- **Fraise HSSCo8, multi-dents trou lisse, ébauche, pas fin**
- **FRESA CILINDRICA FRONTALE MULTI TAGLIENTE, PER SGROSSATURA**

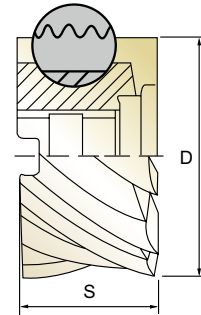
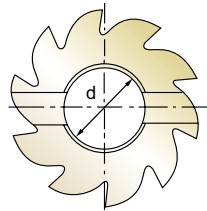

HSS Co8
DIN 841
HR
6-12
30°
P.819

Unit : mm

EDP No.	Mill Diameter	Width of Face	Internal Diameter	No. of Teeth
	D	S	d	Z
E2678401	40.0	40	● 16	6
E2678501	50.0	50	22	8
E2678600	60.0	30	27	8
E2678601	60.0	60	27	8
E2678750	75.0	35	27	10
E2678751	75.0	75	27	10
E2678900	90.0	35	27	10
E2678902	110.0	35	32	12

- Tolerance of Internal Diameter = +0.018 ~ 0
- ▶ TIN-COATING, TiCN-COATING & TiAIN-COATING is available on your request.

HSS Co8
DIN 1880
HR
6-12
30°
P.819

Unit : mm

EDP No.	Mill Diameter	Width of Face	Internal Diameter	No. of Teeth
	D	S	d	Z
E2678400	40.0	32	● 16	6
E2678500	50.0	36	22	8
E2678630	63.0	40	27	8
E2678800	80.0	45	27	10
E2678901	100.0	50	32	10
E2678903	125.0	56	40	12
E2678904	160.0	63	50	12

- Tolerance of Internal Diameter = +0.018 ~ 0
- ▶ TIN-COATING, TiCN-COATING & TiAIN-COATING is available on your request.

Mill Dia. Tolerance(mm)	Width of Face Tolerance(mm)	Internal Dia. Tolerance(mm)
+ 0.25 - 0.15	+ 0.5 - 0	+ 0.02 - 0

◎ : Excellent ○ : Good

ISO Material Description	P											M			K					
	Non-alloy steel					Low alloy steel				High alloyed steel, and tool steel		Stainless steel			Grey cast iron		Nodular cast iron		Malleable cast iron	
VDI 3323	1	2	3	4	5	6	7	8	9	10	11	12	13	14	15	16	17	18	19	20
HRc	13	25	28	32	10	29	32	38	15	35	15	23	10	10	26	3	25			
HB	125	190	250	270	300	180	275	300	350	200	325	200	240	180	180	260	160	250	130	230
Recommended	◎	◎	◎	◎	◎	◎	◎	◎	◎	◎	◎	◎	◎	◎	◎	◎	◎	◎	◎	◎

ISO Material Description	N										S						H				
	Aluminum-wrought alloy		Aluminum-cast, alloyed			Copper and Copper Alloys (Bronze / Brass)			Non Metallic Materials		Heat Resistant Super Alloys						Titanium Alloys		Hardened steel	Chilled Cast Iron	Hardened Cast Iron
VDI 3323	21	22	23	24	25	26	27	28	29	30	31	32	33	34	35	36	37	38	39	40	41
HRc											15	30	25	38	34			55	60	42	55
HB	60	100	75	90	130	110	90	100			200	280	250	350	320	400 Rm	1050 Rm	550	630	400	550
Recommended	◎	◎	◎	◎	◎	◎	◎	◎	◎	◎	◎	◎	◎	◎	◎	◎	◎	◎	◎	◎	◎

HSSCo8, MULTI FLUTE ROUGHING & FINISHING SHELL END MILL

- HSSCo8, MULTI SCHNEIDEN WALZENSTIRN-SCHRUPPSCHLICHTFRÄSER
- Fraise HSSCo8, multi-dents trou lisse, ébauche et finition
- FRESA CILINDRICA FRONTALE MULTI TAGLIENTE, SEMI FINITURA

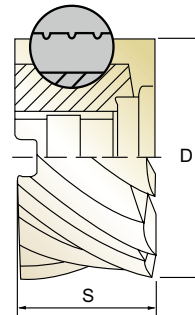
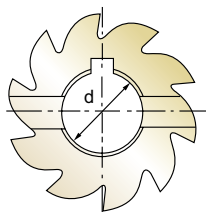

HSS Co8
DIN 841
NF
6-12
30°

P.819

Unit : mm

EDP No.	Mill Diameter	Width of Face	Internal Diameter	No. of Teeth
	D	S	d	Z
E2679401	40.0	40	● 16	6
E2679501	50.0	50	22	8
E2679600	60.0	30	27	8
E2679601	60.0	60	27	8
E2679750	75.0	35	27	10
E2679751	75.0	75	27	10
E2679900	90.0	35	27	10
E2679902	110.0	35	32	12

- Tolerance of Internal Diameter = +0.018 ~ 0
- ▶ TIN-COATING, TiCN-COATING & TiAlN-COATING is available on your request.

HSS Co8
DIN 1880
NF
6-12
30°

P.819

Unit : mm

EDP No.	Mill Diameter	Width of Face	Internal Diameter	No. of Teeth
	D	S	d	Z
E2679400	40.0	32	● 16	6
E2679500	50.0	36	22	8
E2679630	63.0	40	27	8
E2679800	80.0	45	27	10
E2679901	100.0	50	32	10
E2679903	125.0	56	40	12
E2679904	160.0	63	50	12

- Tolerance of Internal Diameter = +0.018 ~ 0
- ▶ TIN-COATING, TiCN-COATING & TiAlN-COATING is available on your request.

Mill Dia. Tolerance(mm)	Width of Face Tolerance(mm)	Internal Dia. Tolerance(mm)
+ 0.25 - 0.15	+ 0.5 - 0	+ 0.02 - 0

◎ : Excellent ○ : Good

ISO Material Description	P										M						K										
	Non-alloy steel					Low alloy steel					High alloyed steel, and tool steel			Stainless steel			Grey cast iron		Nodular cast iron		Malleable cast iron						
VDI 3323	1	2	3	4	5	6	7	8	9	10	10	11	12	13	14	15	16	17	18	19	20						
HRC	13	25	28	32	10	29	32	38	15	35	15	23	10	10	26	3	25	42	55	60	21						
HB	125	190	250	270	300	180	275	300	350	200	325	200	240	180	180	260	160	250	130	230	230						
Recommended	◎	◎	◎	◎	○	◎	◎	○	○	◎	○	○	○	○	○	○	○	○	○	○	○						
ISO Material Description	N										S						H										
	Aluminum-wrought alloy		Aluminum-cast, alloyed			Copper and Copper Alloys (Bronze / Brass)			Non Metallic Materials		Heat Resistant Super Alloys						Titanium Alloys		Hardened steel	Chilled Cast Iron	Hardened Cast Iron						
VDI 3323	21	22	23	24	25	26	27	28	29	30	31	32	33	34	35	36	37	38	39	40	41						
HRC	60	100	75	90	130	110	90	100			15	30	25	38	34	200	280	250	350	320	400 Rm	1050 Rm	550	630	400	550	
Recommended	○	○	○	○	○	○	○	○	○	○	○	○	○	○	○	○	○	○	○	○	○	○	○	○	○	○	○

CBN END MILLS

i-Xmill END MILLS

i-SMART MODULAR END MILLS

X5070 END MILLS

4G MILL END MILLS

X-POWER PRO END MILLS

TitaNox-POWER END MILLS

JET-POWER END MILLS

V7 PLUS END MILLS

ALU-POWER HPC END MILLS

ALU-POWER END MILLS

D-POWER GRAPHITE END MILLS

D-POWER CFRP END MILLS

ROUTERS

CRX S END MILLS

K-2 END MILLS

ONLY ONE COATED PM60 END MILLS

TANK-POWER END MILLS

GENERAL HSS END MILLS

MILLING CUTTERS

TECHNICAL DATA

HSSCo8, 4 FLUTE CORNER ROUNDING CUTTERS

- HSSCo8, 4 SCHNEIDEN VIERTELKREISFRÄSER**
- Fraise HSSCo8, 1/4 de cercle, 4 dents**
- 4 TAGLIENTI PER RAGGIATURA DI SPIGOLI**

▶ These tools can be adapted for many screw machine applications as end forming tools to form a specific radius.

▶ Dieses Werkzeug kann an vielen Screw maschine als Finishingtool für spezielle Radien montiert werden.

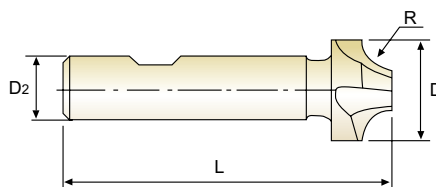

HSS Co8
DIN 6518
N
4
0°
DIN 1835B

P.820

Unit : mm

EDP No.	Radius	Outside Diameter	Shank Diameter	Overall Length
	R(H11)	D	D2(h6)	L
E2498010	R1.0	8.0	10	60
E2498015	R1.5	9.0	10	60
E2498020	R2.0	10.0	10	60
E2498025	R2.5	11.0	10	60
E2498030	R3.0	12.0	12	60
E2498035	R3.5	13.0	12	60
E2498040	R4.0	14.0	12	60
E2498045	R4.5	15.0	12	60
E2498050	R5.0	16.0	12	60
E2498055	R5.5	19.0	16	67
E2498060	R6.0	20.0	16	67
E2498065	R6.5	21.0	16	71
E2498070	R7.0	22.0	16	71
E2498075	R7.5	23.0	16	71
E2498080	R8.0	24.0	16	71
E2498085	R8.5	25.0	25	85
E2498090	R9.0	26.0	25	85
E2498095	R9.5	27.0	25	85

▶ TIN-COATING, TiCN-COATING & TiAIN-COATING is available on your request.

▶ NEXT PAGE

Tolerances according to DIN 7160 & 7161

	Nominal-Diameter in mm					
	from 1 to 3	over 3 to 6	over 6 to 10	over 10 to 18	over 18 to 30	over 30 to 50
	Tolerance range in μm					
H11	+60 0	+75 0	+90 0	+110 0	+130 0	+160 0
h6	0 -6	0 -8	0 -9	0 -11	0 -13	0 -16

◎ : Excellent ○ : Good

ISO Material Description	P										M			K							
	Non-alloy steel					Low alloy steel					High alloyed steel, and tool steel			Stainless steel			Grey cast iron		Nodular cast iron		Malleable cast iron
VDI 3323	1	2	3	4	5	6	7	8	9	10	11	12	13	14	15	16	17	18	19	20	
HRc	13	25	28	32	10	29	32	38	15	35	15	23	10	10	26	3	25				
HB	125	190	250	270	300	180	275	300	350	200	325	200	240	180	180	260	160	250	130	230	
Recommended	◎	◎	◎	◎	◎	◎	◎	◎	◎	◎	◎	◎	◎	◎	◎	◎	◎	◎	◎	◎	
ISO Material Description	N										S							H			
	Aluminum-wrought alloy		Aluminum-cast, alloyed			Copper and Copper Alloys (Bronze / Brass)			Non Metallic Materials		Heat Resistant Super Alloys					Titanium Alloys		Hardened steel	Chilled Cast Iron	Hardened Cast Iron	
VDI 3323	21	22	23	24	25	26	27	28	29	30	31	32	33	34	35	36	37	38	39	40	41
HRc	21	22	23	24	25	26	27	28	29	30	15	30	25	38	34	34	34	55	60	42	55
HB	60	100	75	90	130	110	90	100			200	280	250	350	320	400 Rm	1050 Rm	550	630	400	550
Recommended	◎	◎	◎	◎	◎	◎	◎	◎	◎	◎	◎	◎	◎	◎	◎	◎	◎	◎	◎	◎	◎

HSSCo8, 4 FLUTE CORNER ROUNDING CUTTERS

- HSSCo8, 4 SCHNEIDEN VIERTELKREISFRÄSER
- Fraise HSSCo8, 1/4 de cercle, 4 dents
- ◌ 4 TAGLIANTI PER RAGGIATURA DI SPIGOLI

▶ These tools can be adapted for many screw machine applications as end forming tools to form a specific radius.

▶ Dieses Werkzeug kann an vielen Scrow maschine als Finishingtool für spezielle Radien montiert werden.

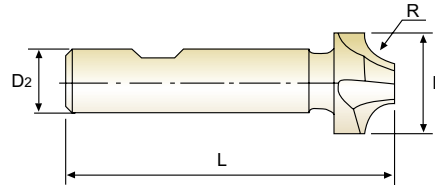

HSS Co8
DIN 6518
N
4
0°
DIN 1835B
P.820

Unit : mm

EDP No.	Radius	Outside Diameter	Shank Diameter	Overall Length
	R(H11)	D	D2(h6)	L
E2498100	R10.0	28.0	25	85
E2498105	R10.5	31.0	25	90
E2498110	R11.0	32.0	25	90
E2498120	R12.0	34.0	25	90
E2498125	R12.5	41.0	25	100
E2498130	R13.0	42.0	25	100
E2498140	R14.0	44.0	25	100
E2498150	R15.0	46.0	25	100
E2498160	R16.0	48.0	25	100
E2498180	R18.0	52.0	32	112
E2498200	R20.0	56.0	32	112

▶ TIN-COATING, TiCN-COATING & TiAIN-COATING is available on your request.

Tolerances according to DIN 7160 & 7161

	Nominal-Diameter in mm					
	from 1 to 3	over 3 to 6	over 6 to 10	over 10 to 18	over 18 to 30	over 30 to 50
	Tolerance range in μm					
H11	+60 0	+75 0	+90 0	+110 0	+130 0	+160 0
h6	0 -6	0 -8	0 -9	0 -11	0 -13	0 -16

◎ : Excellent ○ : Good

ISO Material Description	P										M			K							
	Non-alloy steel					Low alloy steel					High alloyed steel, and tool steel			Stainless steel			Grey cast iron		Nodular cast iron		Malleable cast iron
VDI 3323	1	2	3	4	5	6	7	8	9	10	11	12	13	14	15	16	17	18	19	20	
HRc	13	25	28	32	30	29	32	38	35	35	35	15	23	10	10	26	3	25	42	55	
HB	125	190	250	270	300	180	275	300	350	200	325	200	240	180	180	260	160	250	130	230	
Recommended	◎	◎	◎	◎	○	◎	◎	○	○	◎	◎	◎	◎	◎	◎	◎	◎	◎	◎	◎	

ISO Material Description	N					S					H										
	Aluminum-wrought alloy		Aluminum-cast, alloyed			Copper and Copper Alloys (Bronze / Brass)		Non Metallic Materials			Heat Resistant Super Alloys			Titanium Alloys		Hardened steel	Chilled Cast Iron	Hardened Cast Iron			
VDI 3323	21	22	23	24	25	26	27	28	29	30	31	32	33	34	35	36	37	38	39	40	41
HRc	60	100	75	90	130	110	90	100			15	30	25	38	34	400 Rm	1050 Rm	550	630	42	55
HB	60	100	75	90	130	110	90	100			200	280	250	350	320	400 Rm	1050 Rm	550	630	400	550
Recommended	○	○	○	○	○	○	○	○	○	○	○	○	○	○	○	○	○	○	○	○	○



RECOMMENDED CUTTING CONDITIONS
EMPFOHLENE SCHNEIDPARAMETER

ML012, ML112, ML022, ML122, ML212, ML222 SERIES

MULTI FLUTE DOVETAIL CUTTERS
TYPE 'A', 'C', 'E'

Vc = m/min.
fz = mm/tooth
RPM = rev./min.
FEED = mm/min.

ISO	VDI 3323	Material Description	Parameter	Diameter (Ø)							
				16.0	20.0	25.0	32.0	40.0	50.0	63.0	
P	1	Non-alloy steel	Vc	30	30	30	30	30	30	30	30
			fz	0.03	0.037	0.026	0.042	0.043	0.03	0.031	
			RPM	597	477	382	298	239	191	152	
	FEED		107	106	79	125	123	92	75		
	2		Vc	15	15	15	15	15	15	15	
			fz	0.031	0.036	0.031	0.041	0.043	0.026	0.031	
			RPM	298	239	191	149	119	95	76	
	FEED		56	52	47	61	62	40	38		
	3-4		Vc	10	10	10	10	10	10	10	
			fz	0.031	0.035	0.028	0.04	0.042	0.03	0.033	
			RPM	199	159	127	99	80	64	51	
	FEED		37	33	29	40	40	31	27		
5	Vc	10	10	10	10	10	10	10			
	fz	0.021	0.02	0.02	0.02	0.022	0.02	0.023			
	RPM	199	159	127	99	80	64	51			
FEED	25	19	20	20	21	20	19				
6	Vc	15	15	15	15	15	15	15			
	fz	0.031	0.036	0.031	0.041	0.043	0.026	0.031			
	RPM	298	239	191	149	119	95	76			
FEED	56	52	47	61	62	40	38				
7	Vc	10	10	10	10	10	10	10			
	fz	0.031	0.035	0.028	0.04	0.042	0.03	0.033			
	RPM	199	159	127	99	80	64	51			
FEED	37	33	29	40	40	31	27				
8-9	Vc	10	10	10	10	10	10	10			
	fz	0.021	0.02	0.02	0.02	0.022	0.02	0.023			
	RPM	199	159	127	99	80	64	51			
FEED	25	19	20	20	21	20	19				
10	Vc	15	15	15	15	15	15	15			
	fz	0.031	0.036	0.031	0.041	0.043	0.026	0.031			
	RPM	298	239	191	149	119	95	76			
FEED	56	52	47	61	62	40	38				
11.1	Vc	10	10	10	10	10	10	10			
	fz	0.021	0.02	0.02	0.02	0.022	0.02	0.023			
	RPM	199	159	127	99	80	64	51			
FEED	25	19	20	20	21	20	19				
N	21~25	Aluminum-wrought alloy, Aluminum-cast, alloyed	Vc	95	85	90	90	95	85	90	
			fz	0.03	0.04	0.029	0.041	0.042	0.03	0.033	
			RPM	1890	1353	1146	895	756	541	455	
			FEED	340	325	266	367	381	260	240	

ML032, ML132, ML042, ML142, ML232, ML242 SERIES

MULTI FLUTE DOVETAIL CUTTERS
TYPE 'B', 'D', 'F'

Vc = m/min.
fz = mm/tooth
RPM = rev./min.
FEED = mm/min.

ISO	VDI 3323	Material Description	Parameter	Diameter (Ø)			
				16.0	20.0	25.0	32.0
P	1	Non-alloy steel	Vc	30	30	30	30
			fz	0.03	0.037	0.026	0.042
			RPM	597	477	382	298
			FEED	107	106	79	125
	2		Vc	15	15	15	15
			fz	0.031	0.036	0.031	0.041
			RPM	298	239	191	149
			FEED	56	52	47	61
	3-4		Vc	10	10	10	10
			fz	0.031	0.035	0.028	0.04
			RPM	199	159	127	99
			FEED	37	33	29	40
5	Vc	10	10	10	10		
	fz	0.021	0.02	0.02	0.02		
	RPM	199	159	127	99		
	FEED	25	19	20	20		
6	Vc	15	15	15	15		
	fz	0.031	0.036	0.031	0.041		
	RPM	298	239	191	149		
	FEED	56	52	47	61		
7	Vc	10	10	10	10		
	fz	0.031	0.035	0.028	0.04		
	RPM	199	159	127	99		
	FEED	37	33	29	40		
8-9	Vc	10	10	10	10		
	fz	0.021	0.02	0.02	0.02		
	RPM	199	159	127	99		
	FEED	25	19	20	20		
10	Vc	15	15	15	15		
	fz	0.031	0.036	0.031	0.041		
	RPM	298	239	191	149		
	FEED	56	52	47	61		
11.1	Vc	10	10	10	10		
	fz	0.021	0.02	0.02	0.02		
	RPM	199	159	127	99		
	FEED	25	19	20	20		
N	21~25	Aluminum-wrought alloy, Aluminum-cast, alloyed	Vc	95	85	90	90
			fz	0.03	0.04	0.029	0.041
			RPM	1890	1353	1146	895
			FEED	340	325	266	367



RECOMMENDED CUTTING CONDITIONS
EMPFOHLENE SCHNEIDPARAMETER

ML062, ML162, ML262 SERIES

MULTI FLUTES WOODRUFF KEYSEAT CUTTERS
TYPE 'B', 'D', 'F'

Vc = m/min.
fz = mm/tooth
RPM = rev./min.
FEED = mm/min.

ISO	VDI 3323	Material Description	Parameter	Diameter (Ø)								
				10.5	13.5	16.5	19.5	22.5	28.5	32.5	45.5	
P	1	Non-alloy steel	Vc	30	30	30	30	30	30	30	30	30
			fz	0.01	0.01	0.025	0.035	0.04	0.05	0.06	0.07	
			RPM	909	707	579	490	424	335	294	210	
			FEED	73	57	116	137	170	168	212	206	
	2		Vc	20	20	20	20	20	20	20	20	
			fz	0.01	0.01	0.025	0.035	0.04	0.05	0.06	0.07	
			RPM	606	472	386	326	283	223	196	140	
			FEED	49	38	77	91	113	112	141	137	
	3-4		Vc	15	15	15	15	15	15	15	15	
			fz	0.01	0.01	0.025	0.035	0.04	0.05	0.06	0.07	
			RPM	455	354	289	245	212	168	147	105	
FEED		36	28	58	69	85	84	106	103			
5	Vc	10	10	10	10	10	10	10	10			
	fz	0.01	0.01	0.025	0.035	0.04	0.05	0.06	0.07			
	RPM	303	236	193	163	141	112	98	70			
	FEED	24	19	39	46	57	56	71	69			
6	Vc	20	20	20	20	20	20	20	20			
	fz	0.01	0.01	0.025	0.035	0.04	0.05	0.06	0.07			
	RPM	606	472	386	326	283	223	196	140			
	FEED	49	38	77	91	113	112	141	137			
7	Vc	15	15	15	15	15	15	15	15			
	fz	0.01	0.01	0.025	0.035	0.04	0.05	0.06	0.07			
	RPM	455	354	289	245	212	168	147	105			
	FEED	36	28	58	69	85	84	106	103			
8-9	Vc	10	10	10	10	10	10	10	10			
	fz	0.01	0.01	0.025	0.035	0.04	0.05	0.06	0.07			
	RPM	303	236	193	163	141	112	98	70			
	FEED	24	19	39	46	57	56	71	69			
10	Vc	20	20	20	20	20	20	20	20			
	fz	0.01	0.01	0.025	0.035	0.04	0.05	0.06	0.07			
	RPM	606	472	386	326	283	223	196	140			
	FEED	49	38	77	91	113	112	141	137			
11.1	Vc	10	10	10	10	10	10	10	10			
	fz	0.01	0.01	0.025	0.035	0.04	0.05	0.06	0.07			
	RPM	303	236	193	163	141	112	98	70			
	FEED	24	19	39	46	57	56	71	69			
N	21~25	Aluminum-wrought alloy, Aluminum-cast, alloyed	Vc	100	100	100	100	100	100	90	100	
			fz	0.01	0.01	0.025	0.035	0.04	0.05	0.06	0.07	
			RPM	3032	2358	1929	1632	1415	1117	881	700	
			FEED	243	189	386	457	566	558	635	686	

ML072, ML172, ML272 SERIES

MULTI FLUTE T-SLOT CUTTERS
TYPE 'AA', 'AB', 'AD'

Vc = m/min.
fz = mm/tooth
RPM = rev./min.
FEED = mm/min.

ISO	VDI 3323	Material Description	Parameter	Diameter (Ø)												
				12.5	16.0	18.0	19.0	21.0	22.0	25.0	28.0	32.0	50.0	63.0		
P	1	Non-alloy steel	Vc	30	30	30	30	30	30	30	30	30	30	40	50	
			fz	0.008	0.013	0.014	0.017	0.018	0.021	0.028	0.036	0.036	0.037	0.036		
			RPM	764	597	531	503	455	434	382	341	298	255	253		
	FEED		37	47	45	51	49	55	64	74	86	75	73			
	2		Vc	15	15	15	15	15	15	15	15	15	15	20	25	
			fz	0.007	0.011	0.012	0.013	0.016	0.019	0.026	0.037	0.035	0.037	0.04		
			RPM	382	298	265	251	227	217	191	171	149	127	126		
	FEED		16	20	19	20	22	25	30	38	42	38	40			
	3-4		Vc	10	10	10	10	10	10	10	10	10	10	15	15	
			fz	0.005	0.007	0.01	0.014	0.017	0.019	0.022	0.028	0.025	0.028	0.029		
			RPM	255	199	177	168	152	145	127	114	99	95	76		
	FEED		8	8	11	14	15	16	17	19	20	21	18			
6	Vc	15	15	15	15	15	15	15	15	15	15	20	25			
	fz	0.007	0.011	0.012	0.013	0.016	0.019	0.026	0.037	0.035	0.037	0.04				
	RPM	382	298	265	251	227	217	191	171	149	127	126				
FEED	16	20	19	20	22	25	30	38	42	38	40					
7	Vc	10	10	10	10	10	10	10	10	10	10	15	15			
	fz	0.005	0.007	0.01	0.014	0.017	0.019	0.022	0.028	0.025	0.028	0.029				
	RPM	255	199	177	168	152	145	127	114	99	95	76				
FEED	8	8	11	14	15	16	17	19	20	21	18					
10	Vc	15	15	15	15	15	15	15	15	15	15	20	25			
	fz	0.007	0.011	0.012	0.013	0.016	0.019	0.026	0.037	0.035	0.037	0.04				
	RPM	382	298	265	251	227	217	191	171	149	127	126				
FEED	16	20	19	20	22	25	30	38	42	38	40					
N	21~25	Aluminum-wrought alloy, Aluminum-cast, alloyed	Vc	90	90	95	90	95	90	90	90	90	125	145		
			fz	0.008	0.013	0.015	0.017	0.019	0.021	0.026	0.034	0.034	0.036	0.036		
			RPM	2292	1790	1680	1508	1440	1302	1146	1023	895	796	733		
			FEED	110	140	151	154	164	164	179	209	244	229	211		

CBN END MILLS

i-Xmill END MILLS

i-SMART MODULAR END MILLS

X5070 END MILLS

4G MILL END MILLS

X-POWER PRO END MILLS

TitaNox-POWER END MILLS

JET-POWER END MILLS

V7 PLUS END MILLS

ALU-POWER HPC END MILLS

ALU-POWER END MILLS

D-POWER GRAPHITE END MILLS

D-POWER CFRP END MILLS

ROUTERS

CRX S END MILLS

K-2 END MILLS

ONLY ONE COATED PM60 END MILLS

TANK-POWER END MILLS

GENERAL HSS END MILLS

MILLING CUTTERS

TECHNICAL DATA

ML092 SERIES

MULTI FLUTES SIDE AND FACE MILLING CUTTERS WITH STRAIGHT TEETH

Vc = m/min.
fz = mm/tooth
RPM = rev./min.
FEED = mm/min.

ISO	VDI 3323	Material Description	Parameter	Diameter (Ø)				
				50.0	63.0	80.0	100.0	125.0
P	1	Non-alloy steel	Vc	25	25	25	25	25
			fz	0.045	0.058	0.06	0.063	0.066
			RPM	159	126	99	80	64
	FEED		129	161	143	130	126	
	2		Vc	20	20	20	20	20
			fz	0.04	0.036	0.041	0.038	0.05
			RPM	127	101	80	64	51
	FEED		92	80	78	63	76	
	3-4		Vc	15	15	15	15	15
			fz	0.034	0.031	0.033	0.034	0.042
RPM		95	76	60	48	38		
FEED	58	52	47	42	48			
5	Vc	10	10	10	10	10		
	fz	0.031	0.029	0.03	0.03	0.036		
	RPM	64	51	40	32	25		
FEED	36	32	29	25	28			
6	Vc	20	20	20	20	20		
	fz	0.04	0.036	0.041	0.038	0.05		
	RPM	127	101	80	64	51		
FEED	92	80	78	63	76			
7	Vc	15	15	15	15	15		
	fz	0.034	0.031	0.033	0.034	0.042		
	RPM	95	76	60	48	38		
FEED	58	52	47	42	48			
8-9	Vc	10	10	10	10	10		
	fz	0.031	0.029	0.03	0.03	0.036		
	RPM	64	51	40	32	25		
FEED	36	32	29	25	28			
10	Vc	20	20	20	20	20		
	fz	0.04	0.036	0.041	0.038	0.05		
	RPM	127	101	80	64	51		
FEED	92	80	78	63	76			
11.1	Vc	10	10	10	10	10		
	fz	0.031	0.029	0.03	0.03	0.036		
	RPM	64	51	40	32	25		
FEED	36	32	29	25	28			
N	21~25	Aluminum-wrought alloy, Aluminum-cast, alloyed	Vc	100	100	100	100	100
			fz	0.018	0.023	0.026	0.024	0.033
			RPM	637	505	398	318	255
FEED	206	256	248	199	252			

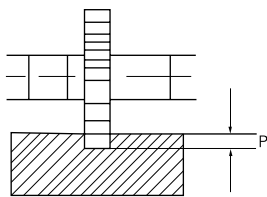

MILLING DEPTH P = WIDTH OF FACES

ML102 SERIES

MULTI FLUTE SIDE AND FACE MILLING CUTTERS WITH STAGGERED TEETH

Vc = m/min.
fz = mm/tooth
RPM = rev./min.
FEED = mm/min.

ISO	VDI 3323	Material Description	Parameter	Diameter (Ø)						
				50.0	63.0	80.0	100.0	125.0	160.0	200.0
P	1	Non-alloy steel	Vc	25	25	25	25	25	25	25
			fz	0.058	0.08	0.081	0.081	0.072	0.081	0.079
			RPM	159	126	99	80	64	50	40
	2		FEED	129	162	145	129	101	105	94
			Vc	20	20	20	20	20	20	20
			fz	0.053	0.052	0.055	0.05	0.055	0.05	0.048
	3-4		RPM	127	101	80	64	51	40	32
			FEED	94	84	79	64	62	52	46
			Vc	15	15	15	15	15	15	15
	5		fz	0.044	0.043	0.044	0.044	0.045	0.044	0.041
			RPM	95	76	60	48	38	30	24
			FEED	59	52	47	42	38	34	29
6	Vc	10	10	10	10	10	10	10		
	fz	0.039	0.04	0.04	0.039	0.039	0.04	0.039		
	RPM	64	51	40	32	25	20	16		
7	FEED	35	32	29	25	22	21	19		
	Vc	20	20	20	20	20	20	20		
	fz	0.053	0.052	0.055	0.05	0.055	0.05	0.048		
8-9	RPM	127	101	80	64	51	40	32		
	FEED	94	84	79	64	62	52	46		
	Vc	15	15	15	15	15	15	15		
10	fz	0.044	0.043	0.044	0.044	0.045	0.044	0.041		
	RPM	95	76	60	48	38	30	24		
	FEED	59	52	47	42	38	34	29		
11.1	Vc	10	10	10	10	10	10	10		
	fz	0.039	0.04	0.04	0.039	0.039	0.04	0.039		
	RPM	64	51	40	32	25	20	16		
N	21~25	Aluminum-wrought alloy, Aluminum-cast, alloyed	FEED	35	32	29	25	22	21	19
			Vc	100	100	100	100	100	100	100
			fz	0.023	0.031	0.035	0.031	0.036	0.029	0.031
			RPM	637	505	398	318	255	199	159
			FEED	205	251	251	197	202	150	148

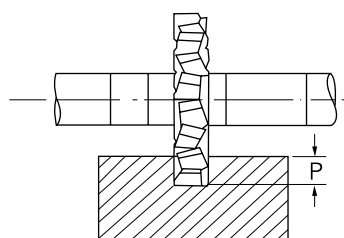

MILLING DEPTH P = WIDTH OF FACES

CBN END MILLS

i-Xmill END MILLS

i-SMART MODULAR END MILLS

X5070 END MILLS

4G MILL END MILLS

X-POWER PRO END MILLS

TitaNox-POWER END MILLS

JET-POWER END MILLS

V7 PLUS END MILLS

ALU-POWER HPC END MILLS

ALU-POWER END MILLS

D-POWER GRAPHITE END MILLS

D-POWER CFRP END MILLS

ROUTERS

CRX S END MILLS

K-2 END MILLS

ONLY ONE COATED PM60 END MILLS

TANK-POWER END MILLS

GENERAL HSS END MILLS

MILLING CUTTERS

TECHNICAL DATA

E2675 SERIES

MULTI FLUTE SHELL END MILL

Vc = m/min.
fz = mm/tooth
RPM = rev./min.
FEED = mm/min.

ISO	VDI 3323	Material Description	Ae	Ap	Parameter	Diameter (Ø)						
						40.0	50.0	63.0	80.0	100.0	125.0	160.0
P	1-2	Non-alloy steel	0.75D	0.25D	Vc	30	30	30	30	30	30	30
					fz	0.07	0.078	0.092	0.1	0.115	0.12	0.131
					RPM	239	191	152	119	95	76	60
	FEED		134	119	112	119	110	110	109			
	3-4		0.75D	0.25D	Vc	25	25	25	25	25	25	30
					fz	0.075	0.077	0.091	0.1	0.119	0.113	0.119
					RPM	199	159	126	99	80	64	60
	FEED		119	98	92	99	95	86	99			
	5		0.75D	0.25D	Vc	20	20	20	20	20	20	20
					fz	0.071	0.078	0.09	0.094	0.117	0.108	0.116
					RPM	159	127	101	80	64	51	40
FEED	90	79	73	75	74	66	65					
6	0.75D	0.25D	Vc	30	30	30	30	30	30	30		
			fz	0.07	0.078	0.092	0.1	0.115	0.12	0.131		
			RPM	239	191	152	119	95	76	60		
FEED	134	119	112	119	110	110	109					
7	0.75D	0.25D	Vc	25	25	25	25	25	25	30		
			fz	0.075	0.077	0.091	0.1	0.119	0.113	0.119		
			RPM	199	159	126	99	80	64	60		
FEED	119	98	92	99	95	86	99					
8	0.75D	0.25D	Vc	20	20	20	20	20	20	20		
			fz	0.071	0.078	0.09	0.094	0.117	0.108	0.116		
			RPM	159	127	101	80	64	51	40		
FEED	90	79	73	75	74	66	65					
9	0.75D	0.25D	Vc	10	10	10	10	10	10	10		
			fz	0.078	0.08	0.1	0.1	0.117	0.146	0.125		
			RPM	80	64	51	40	32	25	20		
FEED	50	41	40	40	37	45	35					
10	0.75D	0.25D	Vc	30	30	30	30	30	30	30		
			fz	0.07	0.078	0.092	0.1	0.115	0.12	0.131		
			RPM	239	191	152	119	95	76	60		
FEED	134	119	112	119	110	110	109					
11.1	0.75D	0.25D	Vc	20	20	20	20	20	20	20		
			fz	0.071	0.078	0.09	0.094	0.117	0.108	0.116		
			RPM	159	127	101	80	64	51	40		
FEED	90	79	73	75	74	66	65					

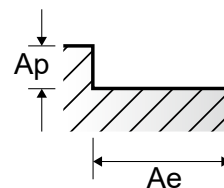

E2676 SERIES

MULTI FLUTE SHELL END MILL for ALUMINUM

ISO	VDI 3323	Material Description	Ae	Ap	Parameter	Diameter (Ø)							
						30.0	40.0	50.0	60.0	63.0	75.0	80.0	100.0
N	21~25	Aluminum-wrought alloy, Aluminum-cast, alloyed	0.75D	0.25D	Vc	100	105	95	95	95	105	100	100
					fz	0.05	0.06	0.069	0.1	0.115	0.13	0.128	0.151
					RPM	1061	836	605	504	480	446	398	318
					FEED	212	201	250	302	331	348	306	288

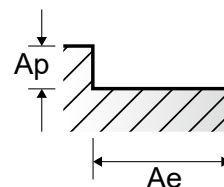

E2677, E2678 SERIES

MULTI FLUTE ROUGHING SHELL END MILL

Vc = m/min.
fz = mm/tooth
RPM = rev./min.
FEED = mm/min.

ISO	VDI 3323	Material Description	Ae	Ap	Parameter	Diameter (Ø)							
						40.0	50.0	63.0	80.0	100.0	125.0	160.0	
P	1-2	Non-alloy steel	0.75D	0.25D	Vc	30	30	30	30	30	30	30	30
					fz	0.069	0.078	0.092	0.1	0.115	0.12	0.153	
	RPM		239	191	152	119	95	76	60				
	FEED		99	119	112	119	110	110	110				
	Vc		25	25	25	25	25	25	30				
	fz		0.071	0.077	0.091	0.1	0.119	0.113	0.139				
	RPM	199	159	126	99	80	64	60					
	FEED	85	98	92	99	95	86	100					
	5	0.75D	0.25D	Vc	20	20	20	20	20	20	20		
				fz	0.071	0.078	0.09	0.094	0.117	0.108	0.135		
	RPM	159	127	101	80	64	51	40					
FEED	68	79	73	75	74	66	64						
6	0.75D	0.25D	Vc	30	30	30	30	30	30	30			
			fz	0.069	0.078	0.092	0.1	0.115	0.12	0.153			
RPM	239	191	152	119	95	76	60						
FEED	99	119	112	119	110	110	110						
7	0.75D	0.25D	Vc	25	25	25	25	25	25	30			
			fz	0.071	0.077	0.091	0.1	0.119	0.113	0.139			
RPM	199	159	126	99	80	64	60						
FEED	85	98	92	99	95	86	100						
8	0.75D	0.25D	Vc	20	20	20	20	20	20	20			
			fz	0.071	0.078	0.09	0.094	0.117	0.108	0.135			
RPM	159	127	101	80	64	51	40						
FEED	68	79	73	75	74	66	64						
9	0.75D	0.25D	Vc	10	10	10	10	10	10	10			
			fz	0.073	0.08	0.1	0.1	0.117	0.146	0.146			
RPM	80	64	51	40	32	25	20						
FEED	35	41	40	40	37	45	35						
10	0.75D	0.25D	Vc	30	30	30	30	30	30	30			
			fz	0.069	0.078	0.092	0.1	0.115	0.12	0.153			
RPM	239	191	152	119	95	76	60						
FEED	99	119	112	119	110	110	110						
11.1	0.75D	0.25D	Vc	20	20	20	20	20	20	20			
			fz	0.071	0.078	0.09	0.094	0.117	0.108	0.135			
RPM	159	127	101	80	64	51	40						
FEED	68	79	73	75	74	66	64						

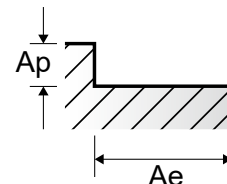

E2679 SERIES

MULTI FLUTE ROUGHING & FINISHING SHELL END MILL

ISO	VDI 3323	Material Description	Ae	Ap	Parameter	Diameter (Ø)						
						40.0	50.0	63.0	80.0	100.0	125.0	160.0
P	1-2	Non-alloy steel	0.75D	0.25D	Vc	30	30	30	30	30	30	30
					fz	0.069	0.078	0.092	0.1	0.115	0.12	0.153
	RPM		239	191	152	119	95	76	60			
	FEED		99	119	112	119	110	110	110			
	Vc		25	25	25	25	25	25	30			
	fz		0.071	0.077	0.091	0.1	0.119	0.113	0.139			
	RPM	199	159	126	99	80	64	60				
	FEED	85	98	92	99	95	86	100				
	5	0.75D	0.25D	Vc	20	20	20	20	20	20	20	
				fz	0.071	0.078	0.09	0.094	0.117	0.108	0.135	
	RPM	159	127	101	80	64	51	40				
FEED	68	79	73	75	74	66	64					
6	0.75D	0.25D	Vc	30	30	30	30	30	30	30		
			fz	0.069	0.078	0.092	0.1	0.115	0.12	0.153		
RPM	239	191	152	119	95	76	60					
FEED	99	119	112	119	110	110	110					
7	0.75D	0.25D	Vc	25	25	25	25	25	25	30		
			fz	0.071	0.077	0.091	0.1	0.119	0.113	0.139		
RPM	199	159	126	99	80	64	60					
FEED	85	98	92	99	95	86	100					
8	0.75D	0.25D	Vc	20	20	20	20	20	20	20		
			fz	0.071	0.078	0.09	0.094	0.117	0.108	0.135		
RPM	159	127	101	80	64	51	40					
FEED	68	79	73	75	74	66	64					
9	0.75D	0.25D	Vc	10	10	10	10	10	10	10		
			fz	0.073	0.08	0.1	0.1	0.117	0.146	0.146		
RPM	80	64	51	40	32	25	20					
FEED	35	41	40	40	37	45	35					
10	0.75D	0.25D	Vc	30	30	30	30	30	30	30		
			fz	0.069	0.078	0.092	0.1	0.115	0.12	0.153		
RPM	239	191	152	119	95	76	60					
FEED	99	119	112	119	110	110	110					
11.1	0.75D	0.25D	Vc	20	20	20	20	20	20	20		
			fz	0.071	0.078	0.09	0.094	0.117	0.108	0.135		
RPM	159	127	101	80	64	51	40					
FEED	68	79	73	75	74	66	64					

CBN END MILLS

i-Xmill END MILLS

i-SMART MODULAR END MILLS

X5070 END MILLS

4G MILL END MILLS

X-POWER PRO END MILLS

TitaNox-POWER END MILLS

JET-POWER END MILLS

V7 PLUS END MILLS

ALU-POWER HPC END MILLS

ALU-POWER END MILLS

D-POWER GRAPHITE END MILLS

D-POWER CFRP END MILLS

ROUTERS

CRX S END MILLS

K-2 END MILLS

ONLY ONE COATED PM60 END MILLS

TANK-POWER END MILLS

GENERAL HSS END MILLS

MILLING CUTTERS

TECHNICAL DATA



RECOMMENDED CUTTING CONDITIONS
EMPFOHLENE SCHNEIDPARAMETER

E2498 SERIES

4 FLUTE CORNER ROUNDING CUTTERS

Vc = m/min.
fz = mm/tooth
RPM = rev./min.
FEED = mm/min.

ISO	VDI 3323	Material Description	Parameter	Diameter (Ø)												
				8.0	9.0	10.0	11.0	12.0	14.0	16.0	20.0	24.0	28.0	34.0	48.0	
P	1	Non-alloy steel	Vc	20	20	20	20	20	20	20	20	20	20	20	20	20
			fz	0.017	0.022	0.02	0.021	0.021	0.025	0.029	0.032	0.038	0.042	0.049	0.058	
			RPM	796	707	637	579	531	455	398	318	265	227	187	133	
	FEED		54	62	51	49	45	45	46	41	40	38	37	31		
	Vc		15	15	15	15	15	15	15	15	15	15	15	15	15	
	fz		0.015	0.016	0.016	0.019	0.019	0.023	0.029	0.033	0.039	0.04	0.048	0.053		
	RPM	597	531	477	434	398	341	298	239	199	171	140	99			
	FEED	36	34	31	33	30	31	35	32	31	27	27	21			
	2	Non-alloy steel	Vc	10	10	10	10	10	10	10	10	10	10	10	10	
			fz	0.018	0.023	0.02	0.024	0.024	0.023	0.03	0.034	0.04	0.05	0.048	0.05	
			RPM	398	354	318	289	265	227	199	159	133	114	94	66	
	FEED		29	33	25	28	25	21	24	22	21	23	18	13		
3-4	Non-alloy steel		Vc	15	15	15	15	15	15	15	15	15	15	15	15	
			fz	0.015	0.016	0.016	0.019	0.019	0.023	0.029	0.033	0.039	0.04	0.048	0.053	
		RPM	597	531	477	434	398	341	298	239	199	171	140	99		
FEED		36	34	31	33	30	31	35	32	31	27	27	21			
6		Low alloy steel	Vc	10	10	10	10	10	10	10	10	10	10	10	10	
			fz	0.018	0.023	0.02	0.024	0.024	0.023	0.03	0.034	0.04	0.05	0.048	0.05	
	RPM		398	354	318	289	265	227	199	159	133	114	94	66		
FEED	29		33	25	28	25	21	24	22	21	23	18	13			
7-8	Low alloy steel		Vc	15	15	15	15	15	15	15	15	15	15	15	15	
			fz	0.015	0.016	0.016	0.019	0.019	0.023	0.029	0.033	0.039	0.04	0.048	0.053	
		RPM	597	531	477	434	398	341	298	239	199	171	140	99		
FEED		36	34	31	33	30	31	35	32	31	27	27	21			
10		High alloyed steel, and tool steel	Vc	10	10	10	10	10	10	10	10	10	10	10	10	
			fz	0.018	0.023	0.02	0.024	0.024	0.023	0.03	0.034	0.04	0.05	0.048	0.05	
	RPM		398	354	318	289	265	227	199	159	133	114	94	66		
FEED	29		33	25	28	25	21	24	22	21	23	18	13			
11.1	High alloyed steel, and tool steel		Vc	15	15	15	15	15	15	15	15	15	15	15	15	
			fz	0.015	0.016	0.016	0.019	0.019	0.023	0.029	0.033	0.039	0.04	0.048	0.053	
		RPM	597	531	477	434	398	341	298	239	199	171	140	99		
FEED		36	34	31	33	30	31	35	32	31	27	27	21			
N		21~25	Aluminum-wrought alloy, Aluminum-cast, alloyed	Vc	90	80	90	85	90	90	80	90	90	85	85	90
				fz	0.018	0.021	0.02	0.023	0.022	0.025	0.031	0.034	0.038	0.045	0.05	0.058
	RPM			3581	2829	2865	2460	2387	2046	1592	1432	1194	966	796	597	
FEED	258			238	229	226	210	205	197	195	181	174	159	138		



Leading Through Innovation



TECHNICAL DATA

TECHNISCHE DATEN



NAMES OF END MILL PARTS
ERLÄUTERUNG DER FRÄSERTEILE

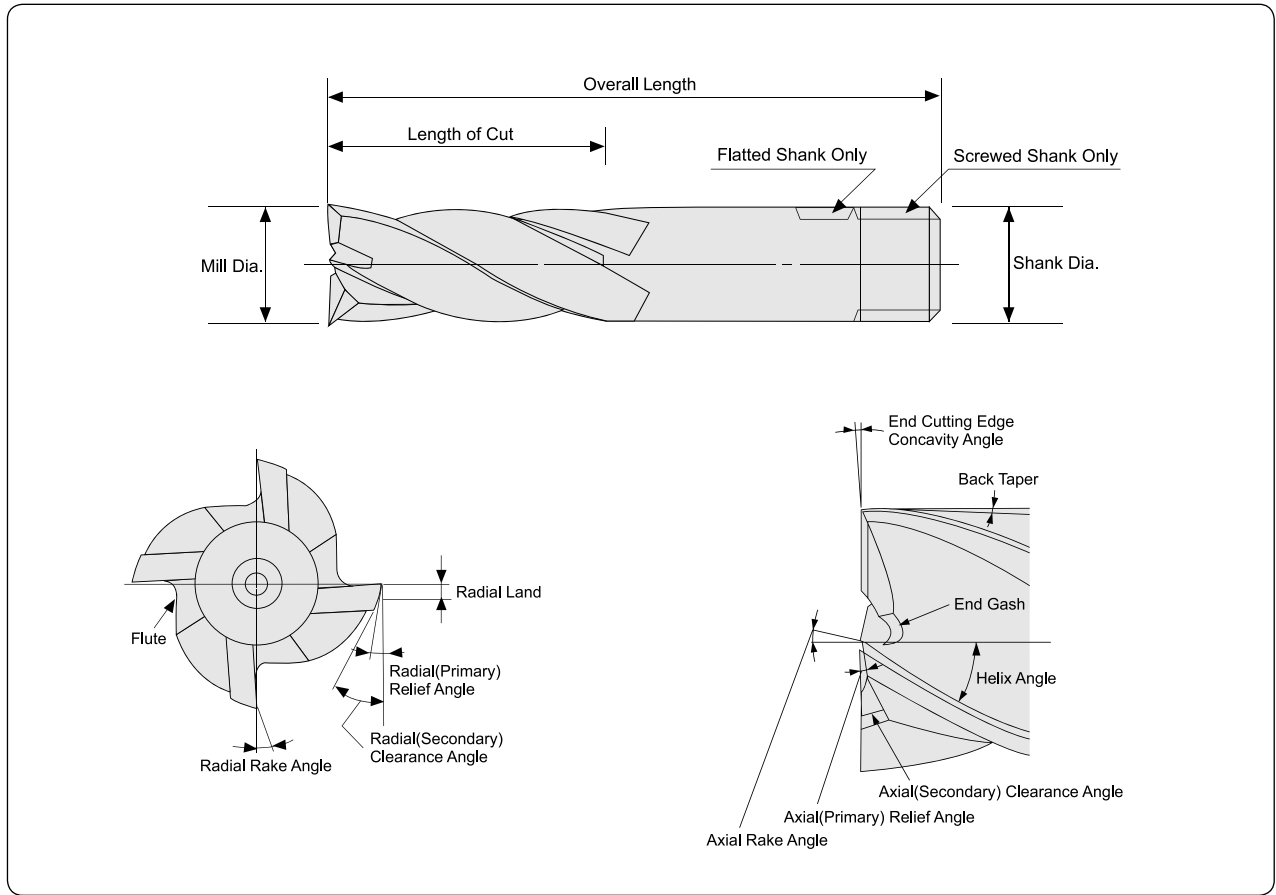

TYPES OF END MILL
FRÄSERTYPEN

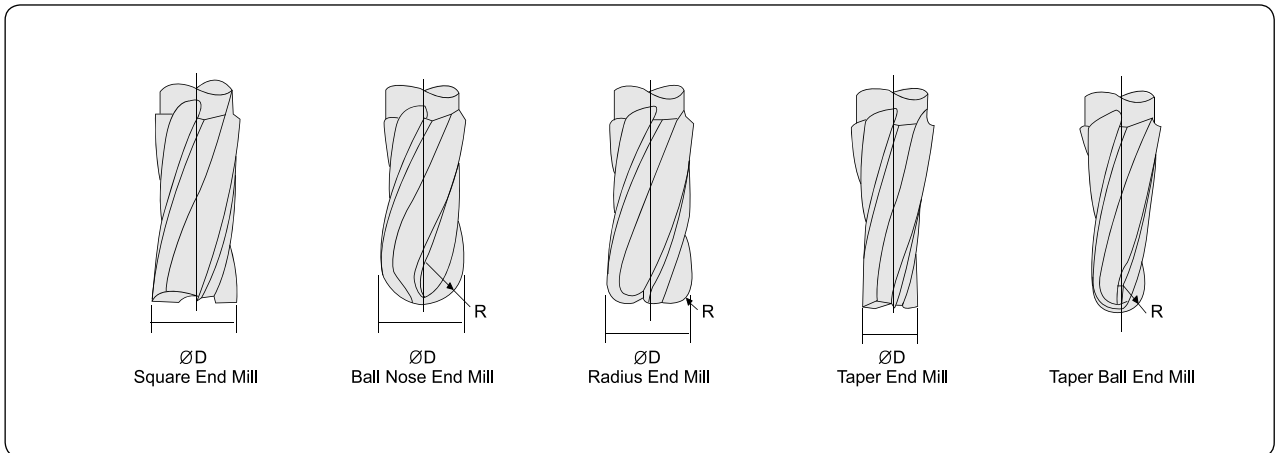



Speed, feed and depth of cut are the most important factors to consider for best results in milling. Improper feeds and speeds often cause low production, poor work quality and unnecessary damage to the cutter.

This section covers the basic principles of speed and feed selection for milling cutters and end mills. It will serve as a guide in setting-up new milling jobs.

Geschwindigkeit, Vorschub und Schnitttiefe sind die wichtigsten Faktoren, um das beste Fräsergebnis zu erzielen. Ungeeignete Vorschübe und Geschwindigkeiten verursachen oft niedrige Produktivität, schlechte Bearbeitungsqualität und unnötige Beschädigung des Fräasers. Dieser Abschnitt beinhaltet die Basisprinzipien von Geschwindigkeit- und Vorschubauswahl für Fräser und Scheibenfräser. Dieser Abschnitt sollte als ein Setting-up-Führer neuer Fräsaufgaben dienen.

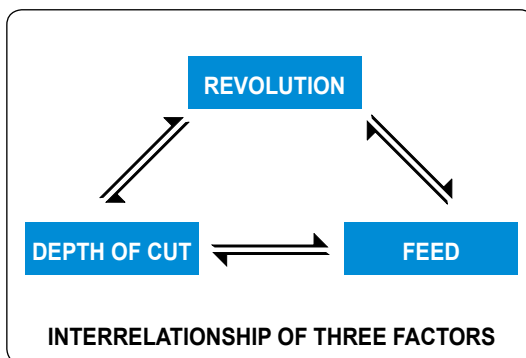

3 SPEEDS GESCHWINDIGKEIT

In milling, SPEED is measured in peripheral feet per minute.(revolution per minute times cutter circumference in feet) This is frequently referred to as "peripheral speed" "cutting speed" or "surface speed".

Beim Fräsen, Geschwindigkeit ist gemessen in Bogenlänge pro Minute. Dies wird oft als 'peripheral speed', 'cutting speed' oder 'surface speed' bezeichnet.

$$N = \frac{1000V}{\pi D}$$

Revolutions per Minute
Umdrehung pro Minute

V : Cutting Speed(m/min) / Schneidgeschwindigkeit
 D : Diameter of Tool(mm) / Werkzeugdurchmesser
 N : Revolution per minute(rev/min) / Umdrehung pro Minute
 π: 3.1416

They will have to be tempered to suit the conditions ON THE JOB. For example:

Dies muß der jeweiligen Aufgabe angepaßt werden. Zum Beispiel:

Use Lower Speed Ranges for Niedrig Geschwindigkeitsbereiche für
Hard materials / Hartes Material Tough materials / Rauhes Material Abrasive materials / Abrasives Material Heavy cuts / Heavy cut Minimum tool wear / Minimale Werkzeugabnutzung Maximum cutter life / Maximale Standzeit

Use Higher Speed Ranges for Hohe Geschwindigkeitsbereiche für
Softer materials / Weiches Material Better finishes / Bessere Oberflächengüte Smaller diameter cutters / Kleinere Fräserdurchmesser Light cuts / Light cut Frail work pieces or set-ups / Zerbrechliche Stücke oder Set-up Hand feed operations / Handarbeit Maximum production rates / Maximale Produktivität Non-metallics / Nichtmetallische Werkstoffe

4 FEEDS VORSCHUB

Feed is usually measured in millimeters per minute. It is the product of feed per tooth times revolution per minute times the number of teeth in the cutter. Due to variations in cutter sizes, numbers of teeth and revolutions per minute, all feed rates should be calculated from feed per tooth. Feed per tooth is the basis of all feed rates per minute, whether the cutters are large or small, fine or coarse tooth, and are run at high or low peripheral speed. Because feed per tooth affects chip thickness. It is a very important factor in cutter life.

Highest possible feed per tooth will usually give longer cutter life between grinds and greater production per grind. Excessive feeds may over load the cutter teeth and cause breakage or chipping of the cutting edges. The following factors should be kept in mind when using the recommended starting feed per tooth.

Vorschub wird meist in Millimeter pro Minute gemessen. Er ist das Produkt von Vorschub pro Zahn, Umdrehung pro Minute oder der Anzahl der Zähne am Werkzeug. Aufgrund der Variationen in Fräsergrößen, Anzahl der Zähne und Umdrehungen pro Minute, Vorschübe sollten mit Vorschub pro Zahn gerechnet werden. Vorschub pro Zahn ist die Basis für alle Vorschubraten pro Minute unabhängig davon, ob die Fräser groß, klein, mit Fein- oder Grobgewinde und mit hoher- oder niedriger Bogengeschwindigkeit arbeiten. Vorschub pro Zahn beeinflusst Spandicke, was für ein Werkzeug ein sehr wichtiger Faktor ist. Höchstmöglicher Vorschub pro Zahn verursacht meist längeres Werkzeugleben zwischen Abnutzung und Produktivität pro Abnutzung. Exzessiver Vorschub dagegen wird den Werkzeugzahn überbelasten und Beschädigungen oder Abbröckelungen von Schneidkanten verursachen. Bei der Nutzung von empfohlenen Vorschüben pro Zahn sollten folgende Faktoren berücksichtigt werden.



Feed in millimeters per Minute / *Vorschub in Milimeter pro Minute*

$$F.M = F.R. \times R.P.M$$

CBN
END MILLSi-Xmill
END MILLS

F.R. : Feed per Revolutions in millimeters / *Vorschub pro Umdrehungen pro Minute*

R.P.M. : Revolutions per Minutes / *Umdrehungen pro Minute*

i-SMART
MODULAR
END MILLS

The following factors should be kept in mind when using the recommended stating feed per tooth.

Die folgenden Faktoren sind beim Einsatz der Vorschübe pro Zahn zu berücksichtigen.

X5070
END MILLS4G MILL
END MILLS
Use Higher Feeds For
Höherer Vorschub für

Heavy, roughing cuts / *Heavy cut, Schruppfräsen*
Rigid set-ups / *Robustes Werkstück*
Easy-to-machine work materials / *Leicht fräsbares Material*
Rugged cutters / *Robuster Fräser*
Slab milling cuts / *Scheibenfräsen*
Low tensile strength materials / *Material von niedriger Zugfestigkeit*
Coarse tooth cutters / *Grobgewinde-Fräser*
Abrasive materials / *Abrasives Material*

Use Lower Feeds For
Niedrigerer Vorschub für

Light, and finishing cuts / *Light cut, Finishing cut*
Frail set-ups / *Zerbrechliches Material*
Hard to machine work materials / *Schwer fräsbares Material*
Frail and small cutters / *Dünne, kleine Fräser*
Deep slots / *Tiefnuten*
High tensile strength materials / *Material von hoher Zugfestigkeit*
Fine tooth cutters / *Feingewinde-Fräser*

X-POWER
PRO
END MILLSTitaNox-
POWER
END MILLSJET-POWER
END MILLSV7 PLUS
END MILLSALU-POWER
HPC
END MILLSALU-
POWER
END MILLSD-POWER
GRAPHITE
END MILLSD-POWER
CFRP
END MILLS

ROUTERS

CRX S
END MILLSK-2
END MILLSONLY ONE
COATED PM60
END MILLSTANK-
POWER
END MILLSGENERAL
HSS
END MILLSMILLING
CUTTERS
**SPEED AND FEED CALCULATIONS
FOR MILLING CUTTERS AND OTHER ROTATING TOOLS**

TO FIND	HAVING	FORMULA
Surface(or Periphery) Speed in meter per Minute=S.P.M.	Diameter of Tool in millimeters Revolutions per Minute =D =R.P.M.	$V = \frac{D \times 3.1416 \times R.P.M.}{1000}$
Revolutions per Minute=R.P.M.	Surface Speed in meter per Minute Diameter of Tool in millimeters =S.P.M =D	$R.P.M. = \frac{V \times 1000}{D \times 3.1416}$
Feed per Revolution in millimeters-F.R.	Feed in millimeters per Minute Revolution per Minute =F.M. =R.P.M.	$F.R. = \frac{F.M.}{R.P.M.}$
Feed in millimeters per Minute-F.M.	Feed per Revolution in millimeters Revolution per Minute =F.R. =R.P.M.	$F.M. = F.R. \times R.P.M.$
Number of Cutting Teeth per Minute=T.M.	Number of Teeth in Tool Revolution per Minute =T =R.P.M.	$T.M = T \times R.P.M.$
Feed per tooth=F.T.	Number of Teeth in Tool Feed per Revolution in millimeters =T =R.P.M.	$F.T. = \frac{F.R.}{T}$
Feed per Tooth=F.T.	Number of Teeth in Tool Feed in millimeters per Minute Speed in Revolution per Minute =T =F.M. =R.P.M.	$F.T. = \frac{F.M.}{T \times R.P.M.}$

**CASE OF RESHARPENING
NACHSCHLEIFFÄLLE**

When the product finish become worse, the cutting edge must get dulled, chips become smaller and the cutting sound gets louder. In such cases, a end mill must be resharpened. The following are the damages of end mills when the resharpening is required.

Wenn die Schneidkante abstumpft, verschlechtert sich die Bearbeitungsqualität, Span wird kürzer und das Fräsergeräusch wird lauter. In solchen Fällen muß der Fräser nachgeschliffen werden. Folgend sind Beschädigungen an Fräser, die das Nachschleifen nötig machen.

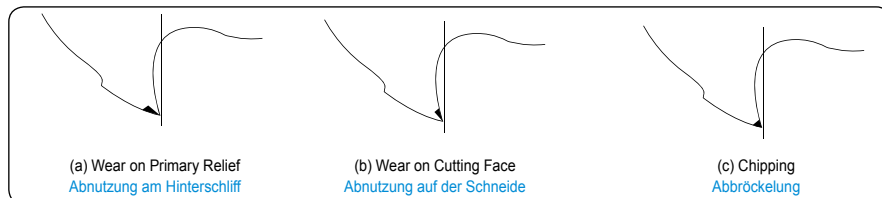

Fig. 1. Damages of Cutting Edge

**SHARPEN AT PREDETERMINED WEAR LAND
SCHLEIFEN BEI VORBESTIMMTEN ABNUTZUNGSFLÄCHEN**

Cutters should be sharpened as soon as the wear land(Fig. 2.) reaches a predetermined width. This width should permit sharpening without excessive loss of tool life. it may vary from a few hundreds to some tenth of a millimeter, depending on the type of cutter and the finish required on the product. This method is used on production runs where uneven amounts of stock is removed or where the material varies in machinability. It is also used on small quantity product lots.

Fräser sollten nachgeschliffen werden, so bald die Abnutzungsfläche die vorbestimmte Breite erreicht. Diese Breite sollte ein Schleifen ohne exzessive Verlust der Werkzeuglebensdauer ermöglichen. Sie variiert, in Abhängigkeit von Werkzeugtypen und benötigtem Finish, von Hunderstel bis einigen Zehntel Millimeter. Diese Methode wird in Prozeßen angewandt, in denen variierende Mengen von Werkstoffen abgefräst oder Materialien verschiedener Fräsbarkeiten bearbeitet werden. Ebenso in Produktionen kleiner Losgrößen.

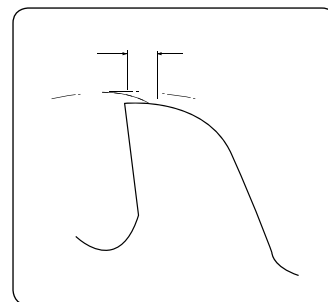

Fig. 2. Wear Land

**RESHARPENING PERIPHERAL CUTTING EDGE
NACHSCHLEIFEN VON PERIPHER-SCHNEIDKANTEN**
1 RESHARPENING PERIPHERAL CUTTING EDGE

Nachschleifen von Primärschneide

The geometry of relief angle in an end mill consist of three methods as shown in Fig.3 concave, flat, and eccentric. Recently, most end mills have the eccentric relief(eccentric sharpening). In this method, since the relief is formed an eccentric are surface in cylindrical grinding method, the roughness of the finished surface of the relief improves and the strength of cutting edge increase at the same time.(Fig.4) As a result, the tool life is improved.

Die Geometrie von Hinterschliffwinkel in einem Fräser hat, wie in Fig. 3 gezeigt, 3 verschiedene Variationen : Konkav, Flach und Exzentrisch. In letzter Zeit, die meisten Fräser haben die exzentrische Form. In dieser Methode verbessern sich Oberflächengüte der bearbeiteten Fläche und die Stärke der Schneidkanten gleichzeitig, was eine Verlängerung der Werkzeuglebensdauer zur Folge hat.

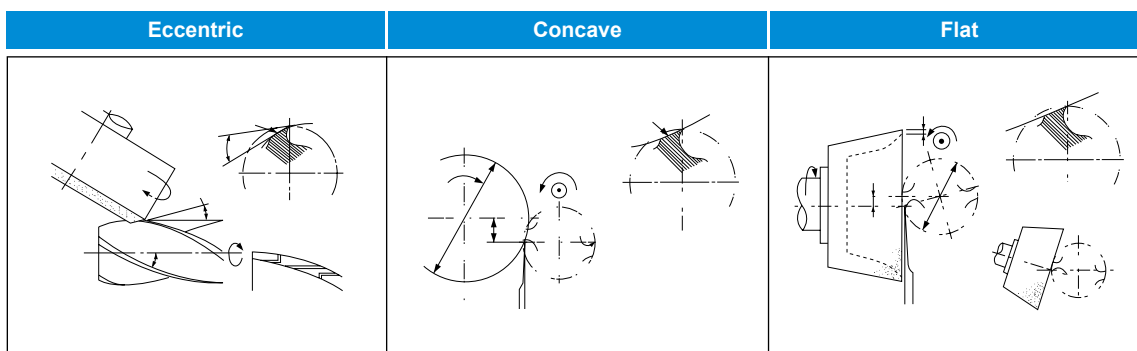

Fig. 3. Three Types of Primary Relief

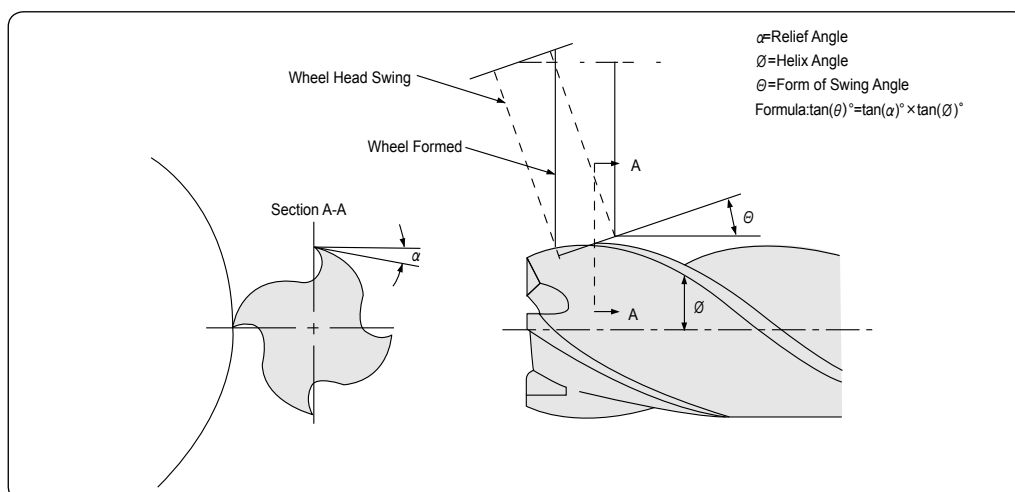

Fig. 4. Tothing of Eccentric Relief Angle

2 ANGLE OF WHEEL INCLINATION

Winkel der Radneigung.

Eccentric relief is produced with a plain wheel positioned with its axis parallel or at a slight angle with the cutter axis. The degree of relief is varied by changing the angle of wheel inclination.

Exzentrischer Hinterschliff wird mit einer, mit der eigenen Achse zur Fräsachse parallelen oder nur geringfügig geneigten Schleifscheibe produziert. Das Grad des Hinterschliffs variiert mit dem Einstellwinkel der Schleifscheiben Einstellung.

Table 1. RECOMMENDED RELIEF ON END MILLS

Mill Diameter (mm)	Eccentric relief indicator drop for relief Angles shown		Checking Distance	Wheel Angles(Deg.) θ			Radial Relief Angles(α 1)	Clearance Angles(α 2)
	Min	Max.		15° Helix	30° Helix	60° Helix		
-	Min	Max.	-	*Angle	*Angle	*Angle	*Angle	*Angle
3.0	0.100	0.130	0.40	4° 24'	9° 25'	26° 28'	16° 02'	25°
6.0	0.090	0.125	0.50	3° 18'	7° 05'	20° 25'	12° 08'	25°
12.0	0.100	0.135	0.65	2° 46'	5° 46'	17° 23'	10° 15'	25°
25.0	0.095	0.140	0.80	2° 15'	4° 15'	14° 16'	8° 21'	25°
40.0	0.085	0.125	0.80	2° 01'	4° 33'	12° 48'	7° 29'	25°
50.0	0.085	0.125	0.80	2° 01'	4° 33'	12° 48'	7° 29'	25°

The actual at the radial relief angle is normally kept within the range shown but may be varied to suit the cutter material, the work material and the operating conditions.

Die Freiwinkel sind normalerweise in den angegebenen Maßen, sie schwanken je nach Werkzeug, Werkstück und den Einsatzbedingungen

* Angle is calculated from the basic mean at the radical angle.

Der Winkel wird von der Hauptschneide zum Radialwinkel gemessen.

8 RESHARPENING END TEETH
NACHSCHLEIFEN DES ENDTZAHNS

The three necessary operations and one option feature, along with setup suggestions are shown in Fig.5 A to D in each drawing, the shaded area indicates the surface being ground.

Die drei nötigen Operationen und eine Option werden, zusammen mit einem Rüstvorschlag, in Bild 5 A bis D gezeigt. Die dunklen Flächen zeigen Bereiche an, die nachgeschliffen werden.

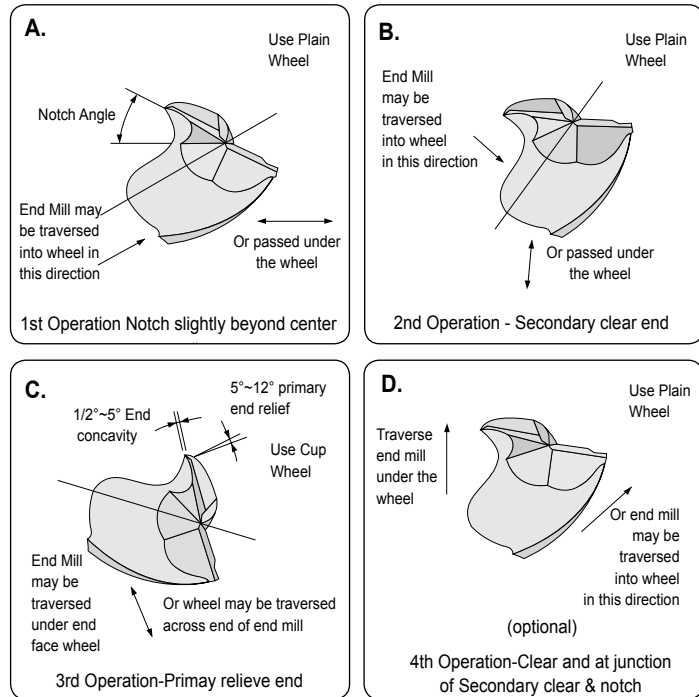

Fig 5. PROCEDURE FOR SHARPENING END OF 2 FLUTE SQUARE END MILLS

9 INSPECTION
INSPEKTION

The inspection is calculated by using the formula shown in Table1.
Procedure To Check Radial Relief Angles With Indicators.

Die Inspektion wird aufgrund der Formel aus der Tabelle 1 durchgeführt.
Prozedur, um mit Indikator radialen Hinterschliffwinkel zu messen.

1. Mount the cutter to rotate freely with no end movement.
2. Adjust the sharp pointed indicator to bear at the very tip of the cutting edge, pointing in a radial line, shown in Fig.6
3. Roll the cutter the tabulated amount gives under "checking distance" using the second indicator as control.
4. Consult chart for amount of drop for the particular diameter and relief angle.

1. Fräser so montieren, daß er frei rotiert ohne sich seitlich zu bewegen.
2. Indikator so justieren, daß der Stab, in radiale Richtung zeigend, am äußersten Rand der Schneidkante angelegt ist (Bild 6).
3. Den Fräser um tabellierte 'Checking distance' rollen. Einen zweiten Indikator zur Kontrolle einsetzen.
4. Um den 'Drop' für den gemessenen Durchmesser und Hinterschliffwinkel zu erhalten, Chart konsultieren.

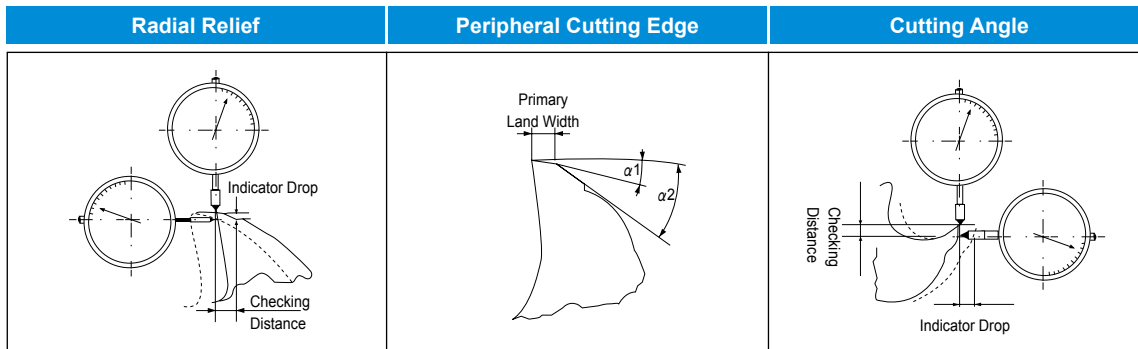

Fig. 6. Indicator Set-Up for Checking

**TROUBLE SHOOTING IN MILLING
PROBLEMLÖSUNG BEI FRÄSEN**

Trouble Problem	Occurrences of trouble Auftreten des Problems	Countermeasures Gegenmaßnahmen
Breaking of tool Werkzeugbruch	<ul style="list-style-type: none"> At time of engaging with work material Beim Eintritt in das Werkstück When ending cut Beim Austritt aus dem Werkstück 	1. Decrease feed rate. / Vermindern von Vorschub 2. Decrease projection amount / Schnitttiefe verringern 3. Shorten cutting edge length to required minimum limit Eingriffslänge reduzieren
	<ul style="list-style-type: none"> During normal cutting Während des Fräsens 	1. Decrease feed rate / Vorschub mindern 2. Control wear → replace tool early Abnutzung kontrollieren - Werkzeug frühzeitig ersetzen 3. Replace chuck or collet / Chuck oder Collet ersetzen 4. Decrease projection amount / Schnitttiefe verringern 5. Carry out honing / Nachschleifen 6. If 4 flute, reduce to 2 flute(clogging of chipping) Wenn 4 Schneiden, zu 2 Schneiden verkleinern 7. If dry cutting change to wet cutting utilize cutting fluid. In case of wet cutting flow oil supplied from the front, change to from rear angle of side top. Use ample with rate. Wenn Trockenfräsen, zu Naßfräsen wechseln. Wenn Naßfräsen mit Kühlfüssigkeitsversorgung von Vorne, zu einer Ölversorgung aus hinterem oder seitlich-oberelem Winkel ändern. Ölversorgung reichlich gestalten
	<ul style="list-style-type: none"> When changing direction of feed Wenn Vorschubrichtung geändert wird 	1. Utilize circular interpolation(in case of NC machine) or temporarily stop feed(Dowelling) Circular interpolation benutzen(bei NC-Maschinen) oder Vorschub vorübergehend stoppen. 2. Reduce feed rate before and after change of directions Vor und nach dem Richtungswechsel den Vorschub mindern 3. Replace chuck or collect / Chuck oder Collet ersetzen,
Fracture of cutting edge Beschädigung der Schneidkante	<ul style="list-style-type: none"> Fracture of corners Eckenbruch 	1. Carry out chamfering or nose with hand lapper. Mit Handlapper eine Abschrägung durchführen. 2. Down cut → Up cut / Down cut → Up cut
	<ul style="list-style-type: none"> Fracture at boundary of depth of cut Beschädigung an der Schneidtiefgrenze 	1. Down cut → Up cut / Down cut → Up cut 2. Reduce cutting speed / Schneidgeschwindigkeit mindern
	<ul style="list-style-type: none"> Chipping at center part or overall Abbröckelung an der Hauptschneide oder überall 	1. Carry out honing. Or enlarge. / Nachschleifen oder erweitern 2. Change number of rotation(in case machine vibrates) Drehzahl ändern(wenn Maschine vibriert). 3. Increase cutting speed / Fräsgeschwindigkeit erhöhen. 4. In ease of squeaking noise during cutting, increase feed. Wenn quitschendes Fräsgeraus zu vernehmen, Vorschub erhöhen. 5. If dry cutting use cutting fluid or blow air. Wenn Trockenfräsen, Kühlfüssigkeit oder Luft zuführen 6. Replace chuck or collet / Chuck oder Collet auswechseln. 7. Reduce cutting speed / Fräsgeschwindigkeit reduzieren.
	<ul style="list-style-type: none"> Large fracturing of cutting edge Größere Beschädigung an Schneidkanten 	1. Decrease feed rate / Vorschub mindern. 2. If 4 flute reduce to 2 flute Wenn 4 Schneiden, zu 2 Schneiden wechseln. 3. Carry out honing. Or enlarge / Nachschleifen oder erweitern. 4. Replace chuck or collet / Chuck oder Collet auswechseln. 5. Reduce cutting speed / Fräsgeschwindigkeit mindern. 6. If dry cutting, change to wet cutting. In case oil supply in wet cutting is from the front, change to rear at an angle or from side top. Use ample supply. Wenn Trockenfräsen, zu Naßfräsen wechseln. Wenn Naßfräsen mit Kühlfüssigkeitsversorgung von Vorne, zu einer Ölversorgung aus hinterem oder seitlich-oberelem Winkel ändern. Ölversorgung reichlich gestalten.



Trouble Problem	Occurrences of trouble Auftreten des Problems	Countermeasures Gegenmaßnahmen
Rapid tool wear Zu schnelle Werkzeugabnutzung		<ol style="list-style-type: none"> 1. Reduce cutting speed / Fräsgeschwindigkeit mindern 2. Up cut → Down cut / Up cut - Down cut 3. Increase feed / Vorschub erhöhen 4. Utilize wet cutting or air / Naßfräsen oder Kühlluft zuführen. 5. If reground tool, improve surface roughness of flank. Beim Nachschleifen, die Oberflächenrauheit der Hauptfreiflächen verbessern.
Inferior finished surface Ungenügende Bearbeitungs Oberfläche	·Surface is good but rough Oberfläche ist gut aber rauh	<ol style="list-style-type: none"> 1. Decrease feed / Vorschub mindern 2. In case using 2 flute, increase to 4 flute Wenn 2 Schneiden, zu 4 Schneiden wechseln
	·Small chip welding Kleine Partikelverschweißung	<ol style="list-style-type: none"> 1. Increase cutting speed / Fräsgeschwindigkeit erhöhen 2. Utilize wet cutting air blow(ample supply) Naßfräsen und Luftzufuhr (reichlich) 3. Carry out fine honing / Feinschliff durchführen 4. Up cut → Down cut / Up cut → Down cut 5. Increase feed or enlarge finish allowance Vorschub erhöhen oder Bearbeitungstoleranz erhöhen
	·With transverse streaks Mit Querstreifen	<ol style="list-style-type: none"> 1. Carry out fine honing / Feinschliff durchführen 2. Use water insoluble cutting fluid Wasserunlösliche Kühlflüssigkeit benutzen. 3. Down cut → Up cut / Down cut → Up cut
	·Signs of excessive cutting Zeichen exzessiven Fräsens	<ol style="list-style-type: none"> 1. Reduce finishing depth of cut / Frästiefe reduzieren. 2. Increase cutting speed / Fräsgeschwindigkeit erhöhen. 3. Reduce feed / Vorschub mindern
Poor machining accuracy Geringe Genauigkeit der Maschine	·Finish dimensions are on minus side Bearbeitungsmaße auf der Minusseite	<ol style="list-style-type: none"> 1. Up cut → Down cut / Up cut → Down cut 2. Reduce finishing depth of cut / Schlichttiefe verringern reduzieren. 3. Replace chuck or collet / Chuck oder Collet austauschen. 4. Reduce projection amount / Projektionsgröße reduzieren. 5. Increase cutting speed / Fräsgeschwindigkeit reduzieren.
	·Poor perpendicularity Ungenauer Winkel	<ol style="list-style-type: none"> 1. Reduce finishing depth of cut / Finishing-tiefe reduzieren. 2. Replace chuck or collet / Chuck oder Collet austauschen. 3. Reduce projection amount / Projektionsgröße mindern 4. Increase cutting speed / Fräsgeschwindigkeit erhöhen. 5. 2Flute → 4 Flute / 2 Schneiden → 4 Schneiden 6. Reduce feed / Vorschub mindern. 7. Check wear rate → Replace tool Verschleiß überprüfen → Werkzeug austauschen.
Chattering Rattern		<ol style="list-style-type: none"> 1. Increase feed rate(in case over 0.05 mm/Zahn, try reducing) Vorschub erhöhen(wenn über 0.05mm/Tooth Vorschub reduzieren). 2. Change cutting speed / Fräsgeschwindigkeit ändern. 3. Replace chuck or collet / Chuck oder Collet austauschen. 4. Reduce projection amount / Projektionsgröße reduzieren. 5. Use 2 flute cutter for rough cutting and 4 flute for finishing 2 Schneiden Fräser zum Schruppen und 4 für Finishing einsetzen. 6. Down cut → Up cut / Down cut → Up cut

**COMPARISON CHART SCALE FOR HARDNESS
VERGLEICHSTABELLE FÜR HÄRTESKALEN**

	Rockwell Hardness C Scale 150kg Brale (HRC)	Diamond Pyramid Hardness Number. Vickers (HV)	Brinell Hardness Standard 10mm Ball 29.42kN (HB)	Rockwell Hardness A Scale 60kg Brale (HRA)	Shore Scleroscope Hardness Number (HS)	Approx. Tensile Strength N/mm ²
	68	940	-	85.6	97	-
	67	900	-	85.5	95	-
	66	865	-	84.5	92	-
	65	832	-	83.9	91	-
	64	800	-	83.4	88	-
	63	772	-	82.8	87	-
	62	746	-	82.3	85	-
	61	720	-	81.8	83	-
	60	697	-	81.2	81	-
	59	674	-	80.7	80	-
	58	653	-	80.1	78	-
	57	633	-	79.6	76	-
	56	613	-	79.0	75	-
	55	595	-	78.5	74	2079
	54	577	-	78.0	72	2010
	53	560	-	77.4	71	1952
	52	544	500	76.8	69	1883
	51	528	487	76.3	68	1824
	50	513	475	75.9	67	1755
	49	498	464	75.2	66	1687
	48	484	451	74.7	64	1639
	47	471	442	74.1	63	1578
	46	458	432	73.6	62	1530
	45	446	421	73.1	60	1481
	44	434	409	72.5	58	1432
	43	423	400	72.0	57	1383
	42	412	390	71.5	56	1334
	41	402	381	70.9	55	1294
	40	392	371	70.4	54	1245
	39	382	362	69.9	52	1216
	38	372	353	69.4	51	1177
	37	363	344	68.9	50	1157
	36	354	336	68.4	49	1118
	35	345	327	67.9	48	1079
	34	336	319	67.4	47	1059
	33	327	311	66.8	46	1030
	32	318	301	66.3	44	1000
	31	310	294	65.8	43	981
	30	302	286	65.3	42	952
	29	294	279	64.7	41	932
	28	285	271	64.3	41	912
	27	279	264	63.8	40	883
	26	272	258	63.3	38	863
	25	266	253	62.8	38	843
	24	260	247	62.4	37	824
	23	254	243	62.0	36	804
	22	248	237	61.5	35	785
	21	243	231	61.0	35	775
	20	238	226	60.5	34	755
	(18)	230	219	-	33	736
	(16)	222	212	-	32	706
	(14)	213	203	-	31	677
	(12)	204	194	-	29	647
	(10)	196	187	-	28	618
	(8)	188	179	-	27	598
	(6)	180	171	-	26	579
	(4)	173	165	-	25	549
	(2)	166	158	-	24	530
	(0)	160	152	-	24	520

ISO	VDI 3323	Material Description	Composition / Structure / Heat Treatment		HB	HRC	Examples	Page	
P	1	Non-alloyed steel	About 0.15% C	Annealed	125		S15C, C15, 1015	832	
	2		About 0.45% C	Annealed	190	13	S45C, C45, 1045		
	3		About 0.45% C	Quenched & tempered	250	25			
	4		About 0.75% C	Annealed	270	28	SK5, Ck75, 1080		
	5		About 0.75% C	Quenched & Tempered	300	32			
	6	Low-alloyed Steel		Annealed	180	10	SCM440, 42CrMo4, 410		
	7			Quenched & Tempered	275	29			
	8			Quenched & Tempered	300	32			
	9			Quenched & Tempered	350	38			
	10	High-alloyed steel, and tool steel		Annealed	200	15	SKD, D2		
	11			Quenched & Tempered	325	35	SKH, SUH, M42		
M	12	Stainless Steel	Ferritic / Martensitic	Annealed	200	15	SUS 420, X40Cr13, 420	839	
	13		Martensitic	Quenched & Tempered	240	23			
	14		Austenitic		180	10			SUS 316, 316, X5CrNiMo 17 12 2
K	15	Grey cast iron	Pearlitic / Ferritic		180	10	FC, GG, EN-GJL-250	841	
	16		Pearlitic (Martensitic)		260	26			
	17	Nodular cast iron	Ferritic		160	3	FCD, GGG, EN-GJS-500-7		
	18		Pearlitic		250	25			
	19	Malleable cast iron	Ferritic		130		FCMW, FCMP, GTS, GJMB350-10		
	20		Pearlitic		230	21			
N	21	Aluminum-wrought alloy	Not Curable		60		SAE 1000, AlMg 1, 3.3315	843	
	22		Curable Hardened		100		SAE 7050, AlCuMg 1, 3.1325		
	23	Aluminum-cast, alloyed	≤ 12% Si, Not Curable		75		ADC12, G-AlSi12, 3.2581		
	24		≤ 12% Si, Curable Hardened		90		C4BS, G-AlSi10Mg, 3.2381		
	25		> 12% Si, Not Curable		130				
	26	Copper and copper alloys (Bronze / Brass)	Cutting Alloys, PB>1%		110		CuZn36Pb 3, 2.0375		
	27		CuZn, CuSnZn (Brass)		90		CuZn 15, 2.0240		
	28		CuSn, lead-free copper and electrolytic copper		100		G-CuZn40Fe, 2.0590		
	29	Non-metallic materials	Duroplastic, Fiber Reinforced Plastic				CFRP		
	30		Rubber, Wood, etc.						
S	31	Heat resistant super alloys	Fe Based	Annealed	200	15	X12 NiCrSi 36-16, 1.4864	845	
	32			Aged	280	30			
	33		Ni or Co Based	Annealed	250	25			Inconel 718, NiCr20TiAl, 2.4631
	34			Aged	350	38			NiCu30Al, 2.4375
	35			Cast	320	34			G-X120Mn12, 1.3401
	36	Titanium alloys	Pure Titanium		400 Rm		TiAl6V4, 3.7165		
	37		Alpha + Beta Alloys	Hardened	1050Rm				
H	38	Hardened steel	Hardened		550	55	SK3	847	
	39		Hardened		630	60			
	40	Chilled cast iron	Cast		400	42			
	41	Hardened cast iron	Hardened		550	55			

P	VDI 3323 1		Material Description Non-alloyed steel			Composition / Structure / Heat Treatment About 0.15% C, Annealed					HB 125	HRC	
	Mat'l No.	JIS	DIN	AISI/ASTM/SAE	BS	EN	AFNOR	SS	UNI	UNE / IHA	UNS	GOST	Brands
1.0037	STKM 12 C	St 37-2	-	4360 40 B	S235JR	E24-2	1311	Fe 360 B				16D	
1.0038	STKM 12 A	St 37-3	A570.36	4360 40 C	S275J2G3	E28-3	1312	Fe 360 D FF				ST14KP	
1.0045	SM 490 YA	S 355 JR	-	-	S 1207	E36-2	-	Fe 510 BFN					
1.0050	SS 50	St 50-2	A570 Gr. 50	4360 50 B	E 295	A50-2	2172	Fe 490				ST5PS	
1.0060	SM 58	St 60-2	A572 Gr. 65	4360 55 E	-	A60-2	1650	Fe 60-2				ST6PS	
1.0114		S 235 J0	-	En 40C	S 235 J0	E24-3		Fe 360 CFN					
1.0143		S 275 J0	-	-	S 275 J0	E28-3	1414	Fe 430 C					
1.0144	SM41C, SM400	St 44-3 N	A573 Gr. 81	4360 43C	S 275 J2 G3	E28-3	1412	Fe 430 D FF				ST14KP	
1.0149		Ro St 44-2	-	43C	S 275 J0 H	-	1412	Fe430C					
1.0301	S10C	C10	1010	045M10	C10	34C10, XC10		C10	F.1511	G10100		10	
1.0330	SPCC	St 12	-	DC 01	Fe P01	DC 01/Fe P01	1142	Fe P01				15KP	
1.0335	SPHE	D D 13 (StW 24)	A622(1008)	H S 3	D D 13	3C		FeP13				08KP	
1.0338	SPCE	St 4	A620(1008)	14491CR	Fe P04	Fe 14	1147	DC04/FeP04				08JU	
1.0345	SPV 50	P235 GH	A516 Gr. 65	P 235 GH	P 235 GH	A 37 CP	1330	Fe E 235		K02503			
1.0401	S15C	C15	1015	080M15	-	C18RR, XC18	1350	C15, C16	F.1110	G10170		15	
1.0402	S20C	C22	1020	050 A 20	1 C 22	C20	1450	C 20	F.1120	G10200		20	
1.0425	SPV315	P265GH/HII				A42CP	1430	Fe4101KW		K02801		16K	
1.0443	SC 450	GS-45	A2765-35	A1		E23-45M	1305						
1.0539		S355NH				TSE355-4	2134	Fe510B					
1.0545		S355N		4360-50E		E355R	2334	FeE355KG					
1.0546		S355NL		4360-50EE		E355FP	2135	FeE355KT					
1.0547		S355J0H		4360-50C		TSE355-3	2172	Fe510C					
1.0549		S355NLH					2135	Fe510D					
1.0553	SM 520 M	St52-3U	A14880-40	4360-50C		320-560M	1606	Fe510C					
1.0562	SM490A	St E 355	A633 Gr. C	P 355 N		FeE355KGN	2132	Fe E 355 KG		K12000		15GF	
1.0565		W St E 355		P 355 NH		P 355 NH	2106	Fe E 355 KW		K01600			
1.0566	SLA 37	T St E 355		P 355 NL1		P 355 NL1	2107	Fe E 355 KT					
1.0570	SM 50 YA	St 52-3	1	4360-50 C	S355JR	E36-3	2172	Fe 510 B				17G15	
1.0715	SUM22	9SMn28	1213	230M07		S250	1912	CF9SMn28	F.2111	G12130			
1.0718	SUM22L	9SMnPb28	12L13			S250Pb	1914	CF9SMnPb28	F.2112	G12134			
1.0721		10S20	1108	10S20		10S20		CF10S20	F.2121	G11080			
1.0722		10SPb20	11L08			10PbF2		CF10SPb20		G11084			
1.0736	SUM25	9SMn36	1215			S300		CF9Mn36	F.2113	G12150			
1.0737		9SMnPb36	12L14			S300Pb	1926	CF9SMnPb36	F.2114	G12144			
1.0972		S315MC		1501-40F30		E315D							
1.0976		S355MC		1501-43F35		E355D	2642	FeE355TM					
1.0982		S460MC		1501-50F45									
1.0984		S500MC				E490D	2662	FeE490TM					
1.0986		S500MC		1501-60F55		E560D		FeE560TM					
1.1121	S10C	Ck10	1010	040A10		XC10	1265	C10	F.1510	G10100		10	
1.1141	S15	Ck15	1015	040A15	32C	XC15	1370	C15	F.1110	G10150		15	
1.1151	S20C	C22E	1020	055M15		2C22	1450	C20	F.1120	G10230		20	
1.8900	S25C	StE380	A572-60	436055E			2145	FeE390KG					
		St44-2	A36	436043A		NFA35-501E28	1411						
		StE320-3Z		1501160			1421						



P	VDI 3323 2		Material Description Non-alloyed steel			Composition / Structure / Heat Treatment About 0.45% C, Annealed					HB 190	HRC 13	
	Mat'l No.	JIS	DIN	AISI/ASTM/SAE	BS	EN	AFNOR	SS	UNI	UNE / IHA	UNS	GOST	Brands
1.0501	S35C	C35	1035	080A32			1C35	1572	C35	F.113	G10350	35	
1.0503	S45C	C45	1045	060A47			XC42H1TS	1672	C45	F.114	G10450	45	
1.0511	S40C	C40	1040	080M40			1C40		C40	F.114.A	G10400	40	
1.0540	S50C	C50						1674	C50		G10500		
1.0551		GS-52	A2770-36	A2			280-480M	1505					
1.0553	SM 520 M	St52-3U	A14880-40	4360-50C			320-560M	1606	FeS10C				
1.0577		S 355 J 2 G 4	A738	Fe 510 D 2 FF			A52FP	2107					
1.0726		35520	1140	212M36	8M		35MF6	1957			G11400	40	
1.0727		45520	1146				45MF4	1973			G11460		
1.1157		40Mn4	1039	150M36	15		40M5				G10390	40G	
1.1158	S25C	C25E	1025	070M25			XC25		C25	F.1120	G10250	25	
1.1166	SMn433H	34Mn5	1536							T0.B	G15360		
1.1167	SMn438(H)	36Mn5	1335	150M36			40M5	2120	36Mn6	F.1203	G13350	35G2	
1.1170	SCMn1	28Mn6	1330	150M28	14A		20M5		C28Mn	28Mn6	G13300	30G	
1.1178	S30C	C30E		080M30			XC32		C30	2C30	G10300		
1.1180		C35R	1035	080A35			3C35	1572		F.1135	G10350		
1.1181	S35C	C35E	1035	080A35			XC38	1572	C36	F.1130	G10340	35	
1.1191	S45C	Ck45	1045	080A46			XC45	1672	C45	F.1140		45	
1.1206	S50C	C50E	1050	080M50			2C50	1674	C50		G10500	50	
1.1213	S50C	Cf53	1050	070M55			XC48H1TS	1674	C53		G10500	50	

P	VDI 3323 3		Material Description Non-alloyed steel			Composition / Structure / Heat Treatment About 0.45% C, Annealed					HB 250	HRC 25	
	Mat'l No.	JIS	DIN	AISI/ASTM/SAE	BS	EN	AFNOR	SS	UNI	UNE / IHA	UNS	GOST	Brands
1.0481	SG365	17 Mn 4/P 295 GH	A516 Gr. 70	224-460B	P 295 GH		A 48 CP	2102	Fe E 295	A47RC1	K03501	14G2	
1.0501	S35C	C35	1035	080A32			1C35	1572	C35	F.1130	G10350	35	
1.0503	S45C	C45	1045	060A47			XC42H1TS	1672	C45	F.1140	G10450	45	
1.0614		C76D	1074				XC75				G10750		
1.0616		C86D	1086				XC80		C85		G10860		
1.0618		C92D	1095				XC90				G10950		
1.0726		35520	1140	212M36	8M		35MF6	1957			G11400	40	
1.1157		40Mn4	1039	150M36	15		40M5				G10390	40G	
1.1165	SMn433H	30Mn5	1036	120M36			35M5		30Mn5	F.8211	K13300	30G2	
1.1167	SMn438(H)	36Mn5	1335	150M36			40M5	2120	36Mn6	F.1203	G13350	35G2	
1.1186	S40C	C40E	1040	060A40			2C40		C40		G10400		
1.1191	S45C	Ck45	1045	080M46			2C45	1672	C45	F.1140		45	
1.1201	S50C	C45R	1049	080M46			3C45	1660	C45	F.1145		38HM	
1.1213	S50C	Cf53	1050	070M55			XC48H1TS	1674	C53		G10500	50	
1.7242	SCM 418 H	18CrMo4											
1.7337		16CrMo4-4	A387 Gr.12						A18CrMo45KW		K11564	15C M	
1.7362	SCMV 6	12CrMo195 17MnV6		3606-625 436055E			Z10CD5-05 NFA35-501E36		16CrMo205		K41545		

Mat'l No.	JIS	DIN	Material Description			Composition / Structure / Heat Treatment					HB	HRC
			AISI/ASTM/SAE	BS	EN	AFNOR	SS	UNI	UNE / IHA	UNS	GOST	Brands
			Non-alloyed steel			About 0.75% C, Annealed					270	28
1.0603	S70 C-CSP	C67	107	080A67		XC65		C67		G10700		
1.0605		C75	1075	144980HS				C75		G10740	75	
1.1203	S55C	Ck55	1055	060A57		2C55	1655	C55	F.1150	G10550	55	
1.1209		C55R	1055	070M55		3C55		C55	F.1155	G10550		
1.1221	S58C	Ck60	1060	060A62	43D	2C60	1678	C60	F.1150	G10640	60	
1.1231	S70 C-CSP	C67E	1070	060A67		XC68	1770	C70	F.5103	G10700	65GA	
1.1248	C75	C75E	1074	060A78		XC75	1774	C75	F.5107	G10800	75(A)	
1.1269	SK5-CSP	C85E	1086			XC90		C90		G10900	85(A)	
1.1274	SUP4	Ck 101	1095	060 A 96	C 100S	XC100	1870	C100	F.5117	G10950		
1.1545	SK3	C 105 W1	W1	BW 2	C 105U	Y1 105	1880	C 100 KU	F.5118		U10A	
1.1663	SK2	C125W	W112			Y2120					U13	

Mat'l No.	JIS	DIN	Material Description			Composition / Structure / Heat Treatment					HB	HRC
			AISI/ASTM/SAE	BS	EN	AFNOR	SS	UNI	UNE / IHA	UNS	GOST	Brands
			Non-alloyed steel			About 0.75% C, Quenched & Tempered					300	32
1.0070		St 70-2	1055	Fe690-2FN	-	A70-2	1655	Fe 690	F.1150		55	
1.0535	S55C	C55	1055	070M55		1C55	1655	C55		J05000	55	
1.0601	S58C	C60	1060	060A62	43D	1C60		C60		G10600	60(G)	
1.1203	S55C	Ck55	1055	060A57		2C55	1655	C55	F.1150	G10550	55	
1.1221	S58C	Ck60	1060	060A62	43D	2C60	1678	C60	F.1150	G10640	60	
1.1274	SUP4	Ck 101	1095	060 A 96	C 100S	XC100	1870	C100	F.5117	G10950		
1.1545	SK3	C 105 W1	W1	BW 2	C 105U	Y1 105	1880	C 100 KU	F.5118		U10A	
1.1663	SK2	C125W	W112			Y2120					U13	
1.5120		38MnSi4										
1.5710	SNC236	36NiCr6	3135	640A35	111A	35NC6						
1.7701		51CrMoV4						51CrMoV4				



Mat'l No.	JIS	DIN	Material Description			Composition / Structure / Heat Treatment					HB	HRC	
			AISI/ASTM/SAE	BS	EN	Annealed					180	10	
			Low-alloyed Steel										
													Brands
1.0116		St 37-3	A570 Gr. 36	4360-40C	S 235 J2 G3	E24-3	1312	Fe 360 D1(2)	AE235D		ST3KP		
1.0904	SKH 1, SKT 4	55Si7	9255	250A53	45	55S7	2085	55Si8	56Si7	G92550	55S2		
1.0961	SUP 7	60SiCr7	9262			60SC6		60SiCr8	60SiCr8	G92620			
1.2067		100Cr6	L3	BL3		Y100C6			100Cr6				
1.2108		90CrSi5	L1				2092	105WCR5					
1.2210		115CrV3	L2			100C3		107CrV3KU	F.520L		11KHF		
1.2241		51CrV4											
1.2330	SCM435TK	35CrMo4	4135	708A37		34CD4	2234	35CrMo4			35KHM		
1.2419	SKS31	105WCr6		105WC13		105WC13	2140	10WCr6			CWG		
1.2510	SKS3	100MnCrW4	01	B01		90MWCV 5	2140	95 MnWCr 5 KU	F.5220		9KHVG		
1.2542		45WCrV7	S1	BS1			2710	45WCrV8KU			5C W25F		
1.2550		60WCrV7	S1			55WC20	2710	58WCr9KU			5KHV25F		
1.2713	SKT4	55NiCrMoV6	L6			55NCDV7			F.520S		5C NM		
1.2721		50NiCr13	L6			55NCV6	2550		F.528				
1.2842		90MnCrV8	02	B02		90MV8				T31502	9G2F		
1.3501		100Cr2	E50100										
1.3505	SUJ2	100Cr6	52100	25135	31	100C6	2258	100Cr6	F.1310		SC C 15		
1.5024		46Si7				45S7		46Si7	F.1451				
1.5025		51Si7	9259H		50Si7	51S7	2090	50Si7	F.1450				
1.5026		55Si7			56Si7	55S7	2085	55Si7	F.1440	G92550	55S2		
1.5027		60Si7	9260	251A60	60Si7	60S7		60Si7	F.1441	G92600	60S2		
1.5028	SUP7	65Si7	9260H										
1.5415	STFA 12	15Mo3	A204Gr.A	1503-243B		15D3	2912	16Mo3(KG)	F.2601	K11820			
1.5419	SCPH11	20Mo4	4419	1503-243-430			2512	G20Mo5		G44190			
1.5423	SB450M	16Mo5	4520	1503-245-420				16Mo5(KG)	F.2602	K11522			
1.5622		14Ni6	A350-LF5			16N6		14Ni6(KG)	F.2641				
1.5732	SNC415(H)	14NiCr10	3415			14NC11		16NiCr11					
1.5752	SNC815(H)	14NiCr14	3310	655M13	36A	12NC15					20X2H4A		
1.6511	SUP10	36CrNiMo4	9840	816M40	110	40NCD3		36NiCrMo4(KB)			40C N2MA		
1.6523	SNCM220(H)	21NiCrMo2	8620	805M20	362	20NCD2	2506	20NiCrMo2			20C GNM		
1.6546	SNCM240	40NiCrMo2-2	8740	311-Tyre7				40NiCrMo2(KB)			38C GNM		
1.6566		17NiCrMo6-4											
1.6587		17CrNiMo6		820A16		18NCD6		14NiCrMo13					
1.6657		10NiCrMo13-4						14NiCrMo131					
1.7015	SCr415(H)	10Cr3	5015	523M15		12C3				G50150	15C		
1.7033	SCr430(H)	34Cr4	5132	530A32	18B	32C4		34Cr4(KB)		G51300	35C		
1.7035	SCr440(H)	41Cr4	5140	530M40	18	42C4	2245	41Cr4		G51400	40H		
1.7131	SCR 415	16MnCr5	5115	527M17		16MCS	2511	16MnCr5		G51150	12KHN2		
1.7139		16MnCr5S					2127				18HG		
1.7176	SUP9(A)	55Cr3	5155	527A60	48	55C3	2253	55Cr3			50C GA		
1.7218	SCM420	25CrMo4	4130	CDS110		25CD4	2225	25CrMo4(KB)			20C M		
1.7220	SCM432	34CrMo4	4135	708 A 37		35CD4	2234	34CrMo4			35C M		
1.7223	SNB22-1	41CrMo4	4142					41CrMo4			40C FA		
1.7225	SCM 440 (H)	42CrMo4	4140	708 M 40	42 CrMo 4	42 CD 4	2244	42 CrMo 4	F.1252		38HM		
1.7228		55NiCrMoV6G		823M30	33		2512	653M31					
1.7262	SCM415(H)	15CrMo5				12CD4	2216	12CrMo4					
1.7321		20mOcr4					2625						
1.7335	SCM415(H)	13CrMo4-4	A182-F11	1501-620		15CD4-5	2216	14CrMo45			12C M		
1.7361		32CrMo12		722M24	40B	30CD12	2240	30CrMo12	F.124A				
1.7380		10CrMo9-10	A182F22	1501-622		12CD9-10	2218	12CrMo9			12KH8		

Mat'l No.	JIS	DIN	Material Description			Composition / Structure / Heat Treatment					HB	HRC		
			AISI/ASTM/SAE	BS	EN	Low-alloyed Steel					Annealed			
Mat'l No.	JIS	DIN	AISI/ASTM/SAE	BS	EN	AFNOR	SS	UNI	UNE / IHA	UNS	GOST	Brands		
1.7715		14MoV6-3		1503-660-440				13MoCrV6						
1.8159	SUP 10	50CrV4	6150	735A50	47	50CrV4	2230	50CrV4		G61500	50C GFA			
1.8161		58CrV4												
1.8509	SACM 645	41CrAlMo7	A355A	905M39	41B	40CAD6-12	2940	41CrAlMo7						
1.8523		39CrMoV13-9		897M39	40C			36CrMoV12						

Mat'l No.	JIS	DIN	Material Description			Composition / Structure / Heat Treatment					HB	HRC		
			AISI/ASTM/SAE	BS	EN	Low-alloyed Steel					Quenched & Tempered			
Mat'l No.	JIS	DIN	AISI/ASTM/SAE	BS	EN	AFNOR	SS	UNI	UNE / IHA	UNS	GOST	Brands		
1.5415	STFA 12	15Mo3	A204Gr.A	1503-243B		15D3	2912	16Mo3(KG)	F.2601	K11820				
1.5423	SB450M	16Mo5	4520	1503-245-420				16Mo5(KG)	F.2602	K11522				
1.5622		14Ni6	A350-LF5			16N6		14Ni6(KG)	F.2641					
1.5732	SNC415(H)	14NiCr10	3415			14NC11		16NiCr11						
1.5752	SNC815(H)	14NiCr14	3310	655M13	36A	12NC15					20X2H4A			
1.5755	SNC236	31NiCr14		653M31		18NC13	2534		F.1270					
1.6565	SNCM447	40NiCrMo6	4340	817M40	24	35NCD6	2541	35NiCrMo6(KB)			38C2N2MA			
1.6587		17CrNiMo6		820A16		18NCD6		14NiCrMo13						
1.6657		10NiCrMo13-4						14NiCrMo131						
1.6957		26NiCrMoV14-5												
1.7015	SCr415(H)	10Cr3	5015	523M15		12C3				G50150	15C			
1.7262	SCM415(H)	15CrMo5				12CD4	2216	12CrMo4						
1.7335	SCM415(H)	13CrMo4-4	A182-F11	1501-620		15CD4-5	2216	14CrMo45			12CM			
1.7380		10CrMo9-10	A182F22	1501-622		12CD9-10	2218	12CrMo9			12KH8			
1.7715		14MoV6-3		1503-660-440				13MoCrV6						
1.7733		24CrMoV55				20CDV6		21CrMoV511						
1.7755		G5-45CrMoV10-4												
1.8070		21CrMoV511						35NiCr9						

Mat'l No.	JIS	DIN	Material Description			Composition / Structure / Heat Treatment					HB	HRC		
			AISI/ASTM/SAE	BS	EN	Low-alloyed Steel					Quenched & tempered			
Mat'l No.	JIS	DIN	AISI/ASTM/SAE	BS	EN	AFNOR	SS	UNI	UNE / IHA	UNS	GOST	Brands		
1.1730		C45W3	C45W			XC48								
1.2332	SCM(440)	47CrMo4	4142	708M40	19A	42CD4	2244	42CrMo4						
1.5736	SNC 631 (H)	36NiCr10	3435			30NC11								
1.6523	SNCM220(H)	21NiCrMo2	8620	805M20	362	20NCD2	2506	20NiCrMo2			20C GNM			
1.7033	SCr430(H)	34Cr4	5132	530A32	18B	32C4		34Cr4(KB)		G51300	35C			
1.7218	SCM420	25CrMo4	4130	CDS110		25CD4	2225	25CrMo4(KB)			20C M			
1.8515		32CrMo12		722M24	40B	30CD12	2240	32CrMo12	F.124A					



Mat'l No.	JIS	DIN	Material Description			Composition / Structure / Heat Treatment					HB	HRC
			AISI/ASTM/SAE	BS	EN	Quenched & Tempered					350	38
<div style="display: flex; justify-content: space-between; align-items: center;"> P VDI 3323 9 Material Description Low-alloyed Steel Composition / Structure / Heat Treatment Quenched & Tempered HB 350 HRC 38 </div>												
Mat'l No.	JIS	DIN	AISI/ASTM/SAE	BS	EN	AFNOR	SS	UNI	UNE / IHA	UNS	GOST	Brands
1.0904	SKH 1, SKT 4	55Si7	9255	250A53	45	55S7	2085	55Si8		G92550	55S2	
1.0961	SUP 7	60SiCr7	9262			60SC6		60SiCr8		G92620		
1.2067		100Cr6	L3	BL3		Y100C6		100Cr6				
1.2419	SKS31	105WCr6		105WC13		105WC13	2140	10WCr6			CWG	
1.2542		45WCrV7	S1	BS1			2710	45WCrV8KU			5CW25F	
1.2713	SKT4	55NiCrMoV6	L6			55NCDV7			F.520S		5C NM	
1.4882		X50CrMnNiNbN219				Z50CMNNb21-09						
1.5120		38MnSi4										
1.5710	SNC236	36NiCr6	3135	640A35	111A	35NC6						
1.5755	SNC236	31NiCr14		830m31		18NC13	2534		F.1270			
1.6511	SUP10	36CrNiMo4	9840	816M40	110	40NCD3		36NiCrMo4(KB)			40C N2MA	
1.6546	SNM240	40NiCrMo2-2	8740	311-Tyre7				40NiCrMo2(KB)			38C GNM	
1.7035	SCr440(H)	41Cr4	5140	530M40	18	42C4	2245	41Cr4		G51400	40H	
1.7176	SUP9(A)	55Cr3	5155	527A60	48	55C3	2253	55Cr3			50C GA	
1.7220	SCM432	34CrMo4	4135	708Aa37		35CD4	2234	34CrMo4			35C M	
1.7223	SNB22-1	41CrMo4	4142					41CrMo4			40C FA	
1.7225	SCM 440 (H)	42CrMo4	4140	708 M 40	42 CrMo 4	42 CD 4	2244	42 CrMo 4	F.1252		38HM	
1.7361		32CrMo12		722M24	40B	30CD12	2240	30CrMo12	F.124A			
1.8159	SUP 10	50CrV4	6150	735A50	47	50CrV4	2230	50CrV4	51CrV4	G61500	50C GFA	
1.8161		58CrV4										
1.8509	SACM 645	41CrAlMo7	A355A	905M39	41B	40CAD6-12	2940	41CrAlMo7				
1.8523		39CrMoV13-9		897M39	40C			36CrMoV12				

Mat'l No.	JIS	DIN	Material Description			Composition / Structure / Heat Treatment					HB	HRC
			AISI/ASTM/SAE	BS	EN	Annealed					200	15
<div style="display: flex; justify-content: space-between; align-items: center;"> P VDI 3323 10 Material Description High-alloyed steel, and tool steel Composition / Structure / Heat Treatment Annealed HB 200 HRC 15 </div>												
Mat'l No.	JIS	DIN	AISI/ASTM/SAE	BS	EN	AFNOR	SS	UNI	UNE / IHA	UNS	GOST	Brands
1.0347	SPCD	RR St3	A619	CR 3	Fe P03	F 13		DC03/FeP03			08JU	
1.0723	SUM32	15S22		210A15			1922		F.210F			
1.2080	SKD1	X210Cr12	D3	BD3	X210Cr12	Z200C12		X205Cr12KU		T30403	KH12	
1.2162	SCR 420 H	21MnCr5				20MCS						
1.2311		40CrMnMo7				40CMD8		35CrMn08KU				
1.2312		40CrMnMoS8.6	P20+S			40CMD8S						
1.2316		X36CrMo17			X38CrMo16							
1.2343	SKD 6	X38CrMoV5-1	H11	BH11		Z38CDV5		X37CrMoV51KU		T20811	4C 5MFS	
1.2344	SKD61	X40CrMoV5-1	H13	BH13		Z40CDV5	2242	X40CrMoV511KU	F.5318	T20813	4C 5MF15	
1.2363	SKD12	X100CrMoV5-1	A2	BA2		Z100CDV5	2260	X100CrMoV51KU	F.5227		9KH5VF	
1.2379	SKD11	X155CrVMo121	D2	BD2		Z160CDV12	2310	X165CrMoW12KU		T30402	KH12MF	KRUPP2379
1.2436	SKD 2	X210CrW12	D4(D6)	BD6		Z200CD12	2312	X215CrW121KU	F.5213		KH12	



Mat'l No.	JIS	DIN	Material Description High-alloyed steel, and tool steel			Composition / Structure / Heat Treatment Annealed					HB 200	HRC 15
			AISI/ASTM/ SAE	BS	EN	AFNOR	SS	UNI	UNE / IHA	UNS	GOST	Brands
1.2510	SKS3	100MnCrW4	01	B01		90 MWCV 5	2140	95 MnWCr 5 KU	F.5220		9KHVG	
1.2581	SKD5	X30WCrV9-3	H21	BH21		Z30WCV9		X30WCrV93KU	F.526	T20821	3C2W8F	
1.2601		X165CrMoV12					2310	X160CrMoV12			KH12MF	
1.2606	SKD 62	X37CrMoW51	H12	BH12		Z35CWDV5		X35CrMoW05KU	F.537	T20812	5C NM	
1.2764		X19NiCrMo4										
1.2767		X45NiCrMo4				45NCD16		40NiCrMoV8KU				
1.2842		90MnCrV8	O2	B02		90MV8		90MnVGr8KU		T31502	9G2F	
1.3243	SKH55	S6-5-2-5	T15			KCV06-05-05-04-02	2723	HS6-5-2-5			R6M5K5	
1.3249	SKH 3	S18-1-2-5	T4	BT4		Z80WKCV18-05-04					R18K5F2	
1.3343	SKH51, SKH9	S6-5-2	M2	BM2		Z85WDCV	2722	HS652	F.5604		R6M5	
1.3348	SKH 58	S2-9-2	M7			Z100DCWV09-04-02	2782	HS292	F.5607			
1.3355	SKH 2	S18-0-1	T1	BT1		Z80WCV18-4-01					R18	
1.4718	SUH1	X45CrSi9-3	HNV3	401545	52	Z45CS9		X45CrSi8	F.322		40C 9S2	
1.5662	SL9N60(53)	X8Ni9	ASMA353	502-650		9Ni		X10Ni9	F.2645			
1.5680		12Ni19	2515	12Ni19		Z18N5						

Mat'l No.	JIS	DIN	Material Description High-alloyed steel, and tool steel			Composition / Structure / Heat Treatment Quenched & Tempered					HB 325	HRC 35
			AISI/ASTM/ SAE	BS	EN	AFNOR	SS	UNI	UNE / IHA	UNS	GOST	Brands
1.2080	SKD1	X210Cr12	D3	BD3	X210Cr12	Z200C12		X205Cr12KU		T30403	KH12	
1.2344	SKD61	X40CrMoV5-1	H13	BH13		Z40CDV5	2242	X40CrMoV511KU	F.5318	T20813	4C5MF1S	
1.2363	SKD12	X100CrMoV5-1	A2	BA2		Z100CDV5	2260	X100CrMoV511KU	F.5227		9KH5VF	
1.2436	SKD 2	X210CrW12	D4(D6)	BD6		Z200CD12	2312	X215CrW121KU	F.5213		KH12	
1.2581	SKD5	X30WCrV9-3	H21	BH21		Z30WCV9		X30WCrV93KU	F.526	T20821	3C2W8F	
1.2601		X165CrMoV12					2310	X160CrMoV12			KH12MF	
1.2714	SKT 4	55NiCrMoV7	6F3/L6			55NiCrMoV7			F.5205		5KHNV	
1.3202		S12-1-4-5		BT15				HS12-1-5-5				
1.3207		S10-4-3-10		BT42		Z130WKCDV						
1.3243	SKH55	S6-5-2-5	T15			KCV06-05-05-04-02	2723	HS6-5-2-5			R6M5K5	
1.3246		S7-4-2-5	M35			Z110WKCDV07-05-04		HS7-4-2-5				
1.3247	SKH 51	S2-10-1-8	M42	BM42		Z110DKCWWV09-08-04		HS2-9-1-8			R2AM9K5	
1.3255	SKH 3	S18-1-2-5	T4	BT4		Z80WKCV18-05-04					R18K5F2	
1.3343	SKH51, SKH9	S6-5-2	M2	BM2		Z85WDCV	2722	HS652	F.5604		R6M5	
1.3348	SKH 58	S2-9-2	M7			Z100DCWV09-04-02	2782	HS292	F.5607			
1.3355	SKH 2	S18-0-1	T1	BT1		Z80WCV18-4-01					R18	
1.4718	SUH1	X45CrSi9-3	HNV3	401545	52	Z45CS9		X45CrSi8	F.322		40C 9S2	
1.4935	SUH 616	X20CrMoWV121	422							S42200		
1.5680		12Ni19	2515	12Ni19		Z18N5						

M		VDI 3323 12		Material Description Stainless steel			Composition / Structure / Heat Treatment					HB	HRC
							Ferritic / Martensitic, Annealed					200	15
Mat'l No.	JIS	DIN	AISI/ASTM/SAE	BS	EN	AFNOR	SS	UNI	UNE / IHA	UNS	GOST	Brands	
1.4000	SUS403	X6Cr13	403	403S17		Z6C13	2301	X6Cr13	F.3110	S40300	08C 13	ATI 410S	
1.4001		X7Cr14	410 S	403S7		Z8C13	2301		F.8401		08C 13		
1.4002	SUS 405	X6CrAl13	405	405S17		Z6CA13	2302	X6CrAl13		S40500			
1.4005	SUS416	X12CrS13	416	416S21		Z11CF13	2380	X12CrS13	F.3411	S41600		ATI 416	
1.4006	SUS410	X12Cr13	410	410S21	56A	Z10C13	2302	X12Cr13	F.3401	S41000	12C 13	ATI 410	
1.4016	SUS430	X6Cr17	430	430S15	X8Cr17	Z8C17	2320	X8Cr17	F.3113	S43000	12C 17	ATI 430	
1.4027	SCS 2	GX20Cr14		420C29		Z20C13M					20C 13L		
1.4028	SUS420J2	X30Cr13	420	420S45		Z30C13	2304			S42020	20C 13		
1.4034	SUS420J2	X46Cr13		420S45		Z40C14		X40Cr14	F.3405				
1.4057	SUS431	X19CrNi17-2	431	431S29	57	Z15CN16-02	2321	X16CrNi16	F.3427	S43100	20C 17N2	431 (HT)	
1.4086		GX120Cr29		452C11									
1.4104	SUS430F	X12CrMoS17	430F	420S37		Z10CF17	2383	X10CrS17	F.3117	S43020			
1.4112	SUS 440 B	X90CrMoV18	440B							S44003	95KH18		
1.4113	SUS434	X6CrMo17	434	434S17		Z8CD17-01	2325	X8CrMo17		S43400		AL 434	
1.4313	SCS5	X3CrNi13-4	CA6-NM	425C11		Z4CND13-04M	2385	(G)X6CrNi304		J91540			
1.4340		GX40CrNi274								J92615			
1.4417		X2CrNiMoSi195	S31500				2376			S39215			
1.4418		X4CrNiMo165				Z6CND16-04-01	2387					APX4	
1.4510	SUS430LX	X6CrTi17	XM8			Z4CT17		X6CrTi17	F.3115	S43035	08C 17T	430 Ti	
1.4511	SUS430LK	X6CrNb17				Z4CNb17		X6CrNb17	F.3122			AXC525	
1.4512	SUH409	X6CrTi12	409	LW19		Z3CT12		X6CrTi12		S40900			
1.4720		X20CrMo13											
1.4724	SUS 405	X10CrAl13	405	403S17		Z10C13		X10CrAl12	F.311		10C 13SJU		
1.4742	SUS430	X10CrAl18	430	439S15	60	Z10CAS18		X8Cr17	F.3113	S43000	15C 13SJU		
1.4747	SUH4	X80CrNiSi20	HNV6	443S65	59	Z80CSN20-02		X80CrSiNi20	F.320B	S65006			
1.4749		X18CrN28	446								15KH28		
1.4762	SUH446	X10CrAl124	446			Z10CAS24	2322	X16Cr26		S44600			
1.4871	SUH35,SUH36	X53CrMnNiN21-9	EV8	349S54		Z52CMN21-09		X53CrMnNiN219		S63008	55C 20G9AN4		
		X10CrNi15	429										
		X12CrNi18-9	302	302S31		Z10CN18-09	2330						

M		VDI 3323 13		Material Description Stainless steel			Composition / Structure / Heat Treatment					HB	HRC
							Martensitic, Quenched & Tempered					240	23
Mat'l No.	JIS	DIN	AISI/ASTM/SAE	BS	EN	AFNOR	SS	UNI	UNE / IHA	UNS	GOST	Brands	
1.4000	SUS403	X6Cr13	403	403S17		Z6C13	2301	X6Cr13	F.3110	S40300	08C 13	ATI 410S	
1.4001		X7Cr14	410 S	403S7		Z8C13	2301		F.8401		08C 13		
1.4006	SUS410	X12Cr13	410	410S21	56A	Z10C13	2302	X12Cr13	F.3401	S41000	12C 13	ATI 410	
1.4016	SUS430	X6Cr17	430	430S15	X8Cr17	Z8C17	2320	X8Cr17	F.3113	S43000	12C 17	ATI 430	
1.4021	SUS 420J1	X20Cr13	420	420S37		Z20C13	2303	14210	F.5261	S42000	20C 13	ATI 420	
1.4027	SCS 2	GX20Cr14		420C29		Z20C13M					20C 13L		
1.4031	SUS 420 J2	X40Cr13	420			Z40C14	-2304		F.3404	S42080	40C 13		
1.4034	SUS420J2	X46Cr13		420S45		Z40C14		X40Cr14	F.3405				
1.4057	SUS431	X19CrNi17-2	431	431S29	57	Z15CN16-02	2321	X16CrNi16	F.3427	S43100	20C 17N2	431 (HT)	
1.4104	SUS430F	X12CrMoS17	430F	420S37		Z10CF17	2383	X10CrS17	F.3117	S43020			
1.4113	SUS434	X6CrMo17	434	434S17		Z8CD17-01	2325	X8CrMo17		S43400		AL 434	
1.4313	SCS5	X3CrNi13-4	CA6-NM	425C11		Z4CND13-04M	2385	(G)X6CrNi304		J91540			
1.4544		A 700	321	S.524		Z 10 CNT 18 11		X6CrNiTi1811		J92630	08C 18N12T		
1.4546		X5CrNiNb18-10	348	347S31				X6CrNiNb1811		J92640		ATI 348	
1.4871	SUH35,SUH36	X53CrMnNiN21-9	EV8	349S54		Z52CMN21-09		X53CrMnNiN219		S63008	55C 20G9AN4		
1.4922		X20CrMoV12-1					2317	x20CrMoNi1201					
1.4923		X22CrMoV121										Jethete X20	

M		VDI 3323 14	Material Description				Composition / Structure / Heat Treatment					HB	HRc
			Stainless steel				Austenitic					180	10
Mat'l No.	JIS	DIN	AISI/ASTM/SAE	BS	EN	AFNOR	SS	UNI	UNE / IHA	UNS	GOST	Brands	
1.4301	SUS 304	X5CrNi18-10	304	304S15		Z5CN18-09	2332		F.3551	S30409	08C 18N10		
1.4305	SUS303	X10CrNiS18-10	303	303S21	58M	Z8CNF18-09	2346	X10CrNiS18.09	F.3508	S30300	30C 18N11	ATI 303	
1.4306	SCS19	X2CrNi1911	304L	304C12	X3CrNi1810KD	Z2CN18-09	2352	GX2CrNi1910	F.3503	S30403	03KH18N11	ATI 304L	
1.4308	SUS304L	GX6CrNi18-9	CF-8	304C15	58E	Z6CN18-10M	2333					CF-8	
1.4310	SUS 301	X10CrNi18-8	301	301S21		Z12CN17-07	2331	X2CrNi1807	F.3517	S30100	07KH16N6	ATI 301	
1.4311	SUS304LN	X2CrNiN18 10	304LN	304S62		Z2CN18-10	2371	X2CrNiN1810	F.3541	S30453	03KH18N11		
1.4312	SCS12	GX10CrNi188	305	302C25		Z10CN18-9M					10C 18N9L	ATI 305	
1.4350	SUS304	X5CrNi18-9	304	304S15	58E	Z6CN18-09	2332	X5CrNi1810	F.3551	S30400		ATI 304	
1.4362		X2CrNiN234	S32304			Z2CN23-04AZ	2327			S32304		ATI 2304TM	
1.4371		X3CrMnNiN18887	202	284S16		Z8CMN18-08-05							
1.4401	SUS316	X5CrNiMo17-12-2	316	316S13		Z3CND17-11-01	2347	X5CrNiMo17 12 2	F.3534	S31600	08KH17H13M2T	ATI 316	
1.4404	SUS316L	X2CrNiMo17-13-2	316L	316S11		Z2CND17-12	2348	X2CrNiMo1712	F.3533	S31603		ATI 316L	
1.4406	SUS316LN	X2CrNiMoN17122	316LN	316S61		Z2CND17-12AZ		X2CrNiMoN1712	F.3542	S31653	07C 18N	ATI 316LN	
1.4408	SCS14	GX6CrNiMo18-10	CF-8M	316C16			2343	X7CrNiMo2010	F.8414	J92900	10G2S2MSL		
1.4410	SCS 14 A	GX10CrNiMo18-9				Z5CND20-12M	2328				S32750		
1.4429	SUS316LN	X2CrNiMoN17-13-3	316Ln	316S62		Z2CND17-13AZ	2375	X2CrNiMoN17133	F.3543		03KH16N15M3		
1.4435	SUS316L	X2CrNiMo18143	316L	316S11		Z3CND17-12-03	2375	X2CrNiMo17 13 2	F.3533	S31603	03C 17N14M3		
1.4436	SUS316	X3CrNiMo17-13-3	316	316S19		Z6CND18-12-03	2343	X5CrNiMo17 12 2	F.3543	S31600			
1.4438	SUS317L	X2CrNiMo18164	317L	317S12		Z2CND19-15-04	2367	X2CrNiMo18 16 4	F.3539	S31703		ATI 317L	
1.4439		X2CrNiMoN17135	(s31726)			Z3CND18-14-06AZ							
1.4440		X2CrNiMo18-16											
1.4449	SUS317	X5CrNiMo17133	317	317S16				X5CrNiMo1815		S31700		ATI 317	
1.4460	SUS 329 J1	X8CrNiMo275	329				2324			S32900		10RE51	
1.4462	SUS329J3L	X2CrNiMoN2253		318S13		Z3CND22-05Az	2377			S31803		ATI 2205TM	
1.4500		X7NiCrMoCuNb2520				Z3NCDU25-20M				J95150			
1.4521	SUS444	X2CrMoTi18-2	443444				2326	X2CrMoTiN18 2	F.3123				
1.4539		X1NiCrMoCuN25205				Z2NCDU25-20	2562			N08904		ATI 904L	
1.4541	SUS321	X14CrNiTi18-10	321	321S31		Z6CNT18-10	2337	X6CrNiTi18 11	F.3523	S32100	06C 18N10T	ATI 321	
1.4542	SUS630	X5CrNiCuNb174	630			Z7CNU15-05						UGIMA 4542	
1.4545		Z7CNU15.05	15-5PH							S15500		ATI 15-5	
1.4547		X1CrNiMoN20187	S31254				2378			S31254		Uranus B25 6Mo	
1.4550	SUS347	X6CrNiNb18-10	347	347S17	58F	Z6CNNb18-10	2338	X6CrNiNb18 11	F.3552	S34700	08C 18N12B	ATI 347	
1.4552	SCS 21	GX7CrNiNb18-9				Z4CNNb19-10M				J92710			
1.4568	SUS 631	X 7 CrNiAl 17 7		316S111		Z 9 CAN 17-7	2388	Z8CNA17-07		S17700	09C 17NUU1	17-7PH	
1.4571	SUS 316Ti	X6CrNiMoTi17-12-2	316Ti	320S31	58J	Z6NDT17-12	2350	X6CrNiMoTi17 12	F.3535		10C 17N13M2T	ATI 316Ti	
1.4581	SCS 22	GX5CrNiMoNb18		318C17		Z4CNDNb18-12M							
1.4583		X6CrNiMoNb18-12	318	303S21		Z15CNS20-12		X15CrNiSi2 12					
1.4585		GX7CrNiMoCuNb1818						X6CrNiMoTi17 12		J94651			
1.4821		X20CrNiSi254				Z20CNS25-04				S44635			
1.4823		GX40CrNiSi274								J92605			
1.4828	SCS17	X15CrNiSi20-12	309	309S24	58C	Z15CNS20-12			F.8414	S30900	20C 20N14S2	ATI 309	
1.4833	SUS 309 S	X6CrNi2213	309S	309S13		Z15CN24-13				J93400			
1.4845	SUH310	X12CrNi25-21	310S	310S24		Z12CN25-20	2361	X6CrNi2520	F.331	S31008	20C 23N18	ATI 310S	
1.4878	SUS321	X12CrNiTi18-9	321	321S20	58B	Z6CNT18-12(B)	2337	X6CrNiTi1811	F.3553	S32100		ACX315	
1.4891		X5CrNiNb18-10	Ss30415				2372						
1.4893		X8CrNiNb11	S30815				2368						
1.4948		X6CrNi1811	304H	304S51		Z5CN18-09	2333			S30480			
1.4980		X5NiCrTi2515	660				2570			S66286		Incoloy A 286	
		X5NiCrN3525											
		X2CrNiMoN18134	S31753										
		X2CrNiMoN25227											

Mat'l No.	JIS	DIN	AISI/ASTM/SAE	BS	EN	AFNOR	SS	UNI	UNE / IHA	UNS	GOST	Brands	VDI 3323 15			
													Material Description	Composition / Structure / Heat Treatment	HB	HRC
													Grey cast iron	Pearlitic / Ferritic	180	10
0.6010	FC100	GG10	A48 20 B	Grade 100	GJL-100	Ft 10 D	0100	G10	FG10		Sc10					
0.6015	FC150	GG15	A48 25 B	Grade 150	GJL-150	Ft 15 D	0115	G15	FG15		Sc15					
0.6020	FC200	GG20	A48 30 B	Grade 220	GJL-200	Ft 20 D	0120	G20	FG20	W06020	Sc20					
0.6025	FC250	GG25	A48 40 B	Grade 260	GJL-250	Ft 25 D	0125	G25	FG25		Sc25					
0.6660		GGL-NiCr 20 2	1050/700/7	Grade F2	GJLA-XNiCr 20-2	L-NC 202	0523	-		F41002		Ni-Resist 2				
1.4449	SUS317	X5CrNiMo17133	317	317S16				X5CrNiMo1815		S31700		ATI 317				

Mat'l No.	JIS	DIN	AISI/ASTM/SAE	BS	EN	AFNOR	SS	UNI	UNE / IHA	UNS	GOST	Brands	VDI 3323 16			
													Material Description	Composition / Structure / Heat Treatment	HB	HRC
													Grey cast iron	Pearlitic (Martensitic)	260	26
0.6025	FC250	GG25	A48 40 B	Grade 260	GJL-250	Ft 25 D	0125	G25	FG25		Sc25					
0.6030	FC300	GG30	A48 45 B	Grade 300	GJL-300	Ft 30 D	0130	G30	FG30		Sc30					
0.6035	FC350	GG35	A48 50 B	Grade 350	GJL-350	Ft 35 D	0135	G35	FG35		Sc35					
0.6040	FC400	GG40	A48 60 B	Grade 400	GJL-400	Ft 40 D	0140	G40	FC40		Sc40					

Mat'l No.	JIS	DIN	AISI/ASTM/SAE	BS	EN	AFNOR	SS	UNI	UNE / IHA	UNS	GOST	Brands	VDI 3323 17			
													Material Description	Composition / Structure / Heat Treatment	HB	HRC
													Nodular cast iron	Ferritic	160	3
0.7033	FCD350-22L	GGG35.3	-	350/22L40	GJS-350-22-LT	FGS 370-17	0717-15	-								
0.7040	FCD400	GGG40	60-40-18	SNG 420-12	GJS-400-15	FCS 400-12	0717-02	GS 400-12	FG E38-17	F32800	Vc 42-12					
0.7043	FCD 370	GGG40.3	60-40-18	SNG 370-17	GJS-400-18-LT	FGS 370-17	0717-12	GS0 42-17			Vc 42-12					
0.6040	FC400	GG40	A48 60 B	Grade 400	GJL-400	Ft 40 D	0140	G40	FC40		Sc40					

Mat'l No.	JIS	DIN	AISI/ASTM/SAE	BS	EN	AFNOR	SS	UNI	UNE / IHA	UNS	GOST	Brands	VDI 3323 18			
													Material Description	Composition / Structure / Heat Treatment	HB	HRC
													Nodular cast iron	Pearlitic	250	25
0.7050	FCD500	GGG50	80-55-06	SNG 500-7	GJS-500-7	FGS 500-7	0727-02	GS 500-7	FG E50-7	F33100	Vc 50-2					
0.7060	FCD600	GGG60	80-55-06	SNG 600-3	GJS-600-3	FGS 600-3	0732-03	GS 600-3	FG E60-2		Vc 60-2					
0.7070	FCD700	GGG70	100-70-03	SNG 700-2	GJS-700-2	FGS 700-2	0737-01	GS 700-2	FG S70-2	F34800	Vc 70-2					
0.7652	FCDA-NiMn 13 7	GGG NiMn 13-7	-	Grade S6	GJSA-XNiMn 13-7	FGS Ni13 Mn7	0772	-				Nodumag				
0.7660		GGG NiCr 20-2	A436 D2	Grade S2	GJSA-XNiCr 20-2	FGS Ni20 Cr2	0776	-				Ni-Resist D-2				

K	VDI 3323 19	Material Description				Composition / Structure / Heat Treatment					HB	HRC
		Malleable cast iron				Ferritic					130	
Mat'l No.	JIS	DIN	AISI/ASTM/SAE	BS	EN	AFNOR	SS	UNI	UNE / IHA	UNS	GOST	Brands
0.8135	FCMW330	GTS-35	32510	B 340-12	GJMB350-10	MN 35-10	0815	GMN 35	GTS35		Kc 35-10	

K	VDI 3323 20	Material Description				Composition / Structure / Heat Treatment					HB	HRC
		Malleable cast iron				Pearlitic					230	21
Mat'l No.	JIS	DIN	AISI/ASTM/SAE	BS	EN	AFNOR	SS	UNI	UNE / IHA	UNS	GOST	Brands
0.8145	FCMW370	GTS-45	A220-40010	P 440-7	GJMB450-6	MN 450	0852	GMN 45				
0.8155	FCMP490	GTS-55	50005	P 510-4	GJMB-550-4	MP 50-5	0854	GMN 55			Kc 60-3	
0.8165	FCMP590	GTS-65	70003	P 570-3	GJMB-650-2	MN 650-3	0856	GMN 65				
0.8170	FCMP690	GTS-70	90001	P 690-2	GJMB-700-2	MN 700-2	0862	GMN 70			Kc 70-2	



N		VDI 3323 21	Material Description Aluminum-wrought alloy				Composition / Structure / Heat Treatment Not Curable					HB 60	HRc
Mat'l No.	JIS	DIN	AISI/ASTM/SAE	BS	EN	AFNOR	SS	UNI	UNE / IHA	UNS	GOST	Brands	
3.0205		Al99	Al99										
3.0255	(A1050)	Al99.5	1000	L31		A59050C					D1		
3.3315		AlMg1											

N		VDI 3323 22	Material Description Aluminum-wrought alloy				Composition / Structure / Heat Treatment Curable, Hardened					HB 100	HRc
Mat'l No.	JIS	DIN	AISI/ASTM/SAE	BS	EN	AFNOR	SS	UNI	UNE / IHA	UNS	GOST	Brands	
3.1325		AlCuMg1									AD35		
3.1655	A2011	AlCuSiPb											
3.2315		AlMgSi1									AK9		
3.4345		AlZnMgCu0,5	7050	L86		AZ4GU/9051		811-04					
3.4365	7075	AlZnMgCu1,5	7075	7075		7075		AlZn5.8MgCuCr			B95		

N		VDI 3323 23	Material Description Aluminum-cast, alloyed				Composition / Structure / Heat Treatment ≤ 12% Si, Not Curable					HB 75	HRc
Mat'l No.	JIS	DIN	AISI/ASTM/SAE	BS	EN	AFNOR	SS	UNI	UNE / IHA	UNS	GOST	Brands	
3.2163		G-AlSi9Cu3									VAL8		
3.2382		GD-AlSi10Mg											
3.2383		G-AlSi0Mg(Cu)	A360.2	LM9			4253						
3.2581		G-AlSi12											
3.3561		G-AlMg5											
3.5101		G-MgZn4sE1Zr1	ZE41	MAG5									
3.5103		MgSE3Zn27r1	EZ33	MAG6		G-TR3Z2							
3.5812		G-MgAl8Zn1	AZ81	NMAG1									
3.5912		G-MgAl9Zn1	AZ91	MAG7									
			A356-72	2789		NFA32-201							
	A5052		356.1	LM25			4244				AK7		
		G-AlSi12	A413.2	LM6			4261						
	ADC12	G-AlSi12(Cu)	A413.1	LM20			4260				AK12		
	A6061	GD-AlSi12	A413.0				4247						
	A7075	GD-AlSi8Cu3	A380.1	LM24			4250						

N		VDI 3323 24	Material Description Aluminum-cast, alloyed			Composition / Structure / Heat Treatment ≤ 12% Si, Curable, Hardened					HB 90	HRc
Mat'l No.	JIS	DIN	AISI/ASTM/SAE	BS	EN	AFNOR	SS	UNI	UNE / IHA	UNS	GOST	Brands
2.1871		G-AlCu4TiMg										
3.1754		G-AlCu5Ni1,5										
3.2371		G-AISI7Mg	4218B								AK8	
3.2373	C4BS	G-AISI9MgWA	SC64D			A-57G	4251				AK9	
3.2381		G-AISI10Mg									AK12	
3.5106		G-MgAg3SE2Zr1	QE22	mag12								
		G-ALMG5	GD-AISI12	LM5		A-SU12	4252					

N		VDI 3323 26	Material Description Copper and Copper Alloys (Bronze / Brass)			Composition / Structure / Heat Treatment Cutting alloys, PB>1%					HB 110	HRc
Mat'l No.	JIS	DIN	AISI/ASTM/SAE	BS	EN	AFNOR	SS	UNI	UNE / IHA	UNS	GOST	Brands
2.0375		CuZn36Pb3									LS60-2	
2.1090		G-CuSn75pb	C93200			U-E7Z5pb4						
2.1096		G-CuSn5ZnPb	c83600	LG2								
2.1098		G-CuSn2Znpb	C83600									
2.1182		G-CuPb15Sn	C23000	LB1		U-pb15E8						

N		VDI 3323 27	Material Description Copper and copper alloys (Bronze / Brass)			Composition / Structure / Heat Treatment CuZn, CuSnZn (Brass)					HB 90	HRc
Mat'l No.	JIS	DIN	AISI/ASTM/SAE	BS	EN	AFNOR	SS	UNI	UNE / IHA	UNS	GOST	Brands
2.0240	C2300	CuZn15									L90	
2.0321		CuZn37	C27200	cZ108		CuZn36,CuZn37		C2700			L63	
2.0590		G-CuZn40Fe										
2.0592		G-CuZn35Al1	C86500	U-Z36N3		HTB1						
2.0596		G-CuZn34Al2	C86200	HTB1		U-Z36N3					LT623AD	
2.1293		CuCrZr	C18200	CC102		U-Cr0-8Zr						

N		VDI 3323 28	Material Description Copper and copper alloys (Bronze / Brass)			Composition / Structure / Heat Treatment CuSn, lead-free copper and electrolytic copper					HB 100	HRc
Mat'l No.	JIS	DIN	AISI/ASTM/SAE	BS	EN	AFNOR	SS	UNI	UNE / IHA	UNS	GOST	Brands
2.0060		E-Cu57										
2.0966		CuAl10Ni5Fe4	C63000	Ca104		U-A10N					BrAD	
2.0975		G-CuAl10Ni	B-148-52									
2.1050		G-CuSn10	c90700	CT1								
2.1052		G-CuSn12	C90800	pb2		UE12P						
2.1292		G-CuCrF35	C81500	CC1-FF								



S

VDI 3323
31

Material Description
Heat resistant super alloys

Composition / Structure / Heat Treatment
Fe Based, Annealed

HB
200

HRC
15

Mat'l No.	JIS	DIN	AISI/ASTM/SAE	BS	EN	AFNOR	SS	UNI	UNE / IHA	UNS	GOST	Brands
1.4558	NCF 800 TB	X2NiCrAlTi3220	N08800	NA15								
1.4562		X1NiCrMoCu32287	N08031									
1.4563		X1NiCrMoCuN31274	N08028			Z1NCU31-27-03	2584				EK77	
1.4864	SUH330	X12NiCrSi36-16	330	NA17		Z12NCS37-18				N08330		
1.4865	SCH15	GX40NiCrSi38-18		330C40				XG50NiCr3919		J94605		
1.4958		X5NiCrAlTi3120										

S

VDI 3323
32

Material Description
Heat resistant super alloys

Composition / Structure / Heat Treatment
Fe Based, Aged

HB
280

HRC
30

Mat'l No.	JIS	DIN	AISI/ASTM/SAE	BS	EN	AFNOR	SS	UNI	UNE / IHA	UNS	GOST	Brands
1.4977		X40CoCrNi2020				Z42CNKDWNb						

S

VDI 3323
33

Material Description
Heat resistant super alloys

Composition / Structure / Heat Treatment
Ni or Co Based, Annealed

HB
250

HRC
25

Mat'l No.	JIS	DIN	AISI/ASTM/SAE	BS	EN	AFNOR	SS	UNI	UNE / IHA	UNS	GOST	Brands
2.4360		NiCu30Fe		NA13		NU30				N04400		Monel400
2.4603		NiCr30 FeMo	5390A			NC2FeD						Hastelloy G-30
2.4610		NiMo16Cr16Ti								N26455		HastelloyC-4
2.4630		NiCr20Ti		HR5,203-4		NC20T				N06075		Nimonic75
2.4631	NCF 80A	NiCr20TiAl		HR40		NC20TA				N07080	KHN77TyR	Nimonic 80A
2.4642	NCF 690	NiCr29Fe				Nnc30Fe				N06690		Inconel 690
2.4856		NiCr22Mo9Nb		NA21		NC22FeDNb				N06625		Inconel 625
2.4858		NiCr21Mo		NA16		NC21FeDU				N08825	KHN38VT	Incoloy 825

S

VDI 3323
34

Material Description
Heat resistant super alloys

Composition / Structure / Heat Treatment
Ni or Co Based, Aged

HB
350

HRC
38

Mat'l No.	JIS	DIN	AISI/ASTM/SAE	BS	EN	AFNOR	SS	UNI	UNE / IHA	UNS	GOST	Brands
2.4375		NiCu30Al	4676	NA18		NU30AT				N05500		Monelk500
2.4662		NiFe35Cr14MoTi	5660			ZSNCDT42				N09901		Incoloy 901
2.4668		NiCr19Fe19NbMo	5383	HR8		NC19eNB				N07718		Inconel 718
2.4670		S-NiCr13Al16MoNb	5391	Mar-46		NC12AD						Nimocast 713
2.4694		NiCr16Fe7TiAl								N07751		Inconel 751
2.4955		NiFe25Cr20NbTi										
2.4964		CoCr20W15Ni	5772			KC20WN						Haynes 25
		CoCr22W14Ni	AMS 5772			KC22WN						



S

VDI 3323
35

Material Description
Heat resistant super alloys

Composition / Structure / Heat Treatment
Ni or Co Based, Cast

HB
320

HRC
34

Mat'l No.	JIS	DIN	AISI/ASTM/SAE	BS	EN	AFNOR	SS	UNI	UNE / IHA	UNS	GOST	Brands
2.4669		NiCr15Fe7TiAl				NC15TNbA				N07750		Inconel X750
2.4685		G-NiMo28								N10665		Hastelloy B
2.4810		G-NiMo30										Hastelloy C
2.4973		NiCr19Co11MoTi	AMS 5399			NC19KDT					VT5-1	
3.7115		TiAl5Sn2								R54520	VT1-00	ATI Grade 6

S

VDI 3323
36

Material Description
Titanium alloys

Composition / Structure / Heat Treatment
Pure Titanium

HB
400 Rm

HRC

Mat'l No.	JIS	DIN	AISI/ASTM/SAE	BS	EN	AFNOR	SS	UNI	UNE / IHA	UNS	GOST	Brands
2.4674		NiCo15Cr10MoAlTi	AMS 5397							N13100		IN 100
3.7025		Ti1	R50250	2TA1						R50250		ATI 30 CP Gr. 1
3.7225		Ti1pd	R52250	TP1						R52250		

S

VDI 3323
37

Material Description
Titanium alloys

Composition / Structure / Heat Treatment
Alpha + Beta Alloys, Hardened

HB
1050 Rm

HRC

Mat'l No.	JIS	DIN	AISI/ASTM/SAE	BS	EN	AFNOR	SS	UNI	UNE / IHA	UNS	GOST	Brands
3.7124		TiCu2		2TA21-24								
3.7145		TiAl6Sn2Zr4Mo2Si	R54620							R54620		
3.7165		TiAl6V4	AMS R56400	TA10-13		T-A6V					VT6	
3.7185		TiAl4Mo4Sn2		TA45-51								
3.7195		TiAl3V2.5								R56320		ATI 3-2.5
		TiAl4Mo4Sn4Si0.5										
		TiAl5Sn2.5	AMS R54520	TA14/17		T-A5E						
		Ti6Al4VELI	AMS R56401	TA11								



H		VDI 3323 38	Material Description Hardened steel				Composition / Structure / Heat Treatment Hardened					HB 550	HRc 55
Mat'l No.	JIS	DIN	AISI/ASTM/SAE	BS	EN	AFNOR	SS	UNI	UNE / IHA	UNS	GOST	Brands	
1.1231	S 70 C-CSP	Ck 67	1070	060 A 67	C 67S	XC 68	1770	C 70	F.5103		70		
1.1248	C 75	Ck 75	1078, 1080	060 A 78	C 75S	XC 75	1774	C 75	F.5107		75		
1.1274	SUP 4	Ck 101	1095	060 A 96	C 100S	XC100	1870	C100	F.5117				
1.1545	SK 3	C 105 W1	W1	BW 2	C 105U	Y1 105	1880	C 100 KU	F.5118		U10A		
1.2762		75CrMoNiW67	-	-	-	-	-	-					
1.3401	SCMnH1	GX120Mn12	A128(A)			Z120M12	2183	GX120Mn12	F.8251		110G13L		
1.4021	SUS 420 J1	X 20 Cr 13	420	420 S 37	X 20 Cr 13	Z 20 C 13	2303	X 20 Cr 13	F.5261		20KH13	ATI 420	
1.4109	SUS 440 A	X 65 CrMo 14	440 A	-	X 70 CrMo 15	Z 70 D 14	-	-				ATI 440A	
1.4112	SUS 440 B	X 90 CrMoV 18	440 B	409 S 19	X 90 CrMoV 18	Z 2 CND 18 05	2327	X CrTi 12					
1.4125	SUS 440 C	X 105 CrMo 17	440 C	-	X 105 CrMo 17	Z 100 CD 17	-	X 105 CrMo 17			95KH18	ATI 440C	
1.6746		32NiCrMo14-5	-	832M31	32nIcRmO145	35NCD14	-	-					
1.7176	SUP9(A)	55Cr3	5155	527A60	48	55C3	2253	55Cr3					
1.7225	SCM 440 (H)	42CrMo4	4140	708 M 40	42 CrMo 4	42 CD 4	2244	42 CrMo 4	F.1252		38HM		

H		VDI 3323 40	Material Description Chilled cast iron				Composition / Structure / Heat Treatment Cast					HB 400	HRc 42
Mat'l No.	JIS	DIN	AISI/ASTM/SAE	BS	EN	AFNOR	SS	UNI	UNE / IHA	UNS	GOST	Brands	
0.9620		GX260NiCr42	A532 IB	Grade 2 A	GJN-HV520	FB Ni4 Cr2 BC	0512	-		F45001		Ni-Hard2	
0.9625		GX330NiCr42	A532 IA	Grade 2 B	GJN-HV550	FB Ni4 Cr2 HC	0513	-		F45000		Ni-Hard1	
0.9630		GX300CrNiSi 9 5 2	A532 ID	Grade 2 C	GJN-HV600	FB Cr9 Ni5	0457	-		F45003		Ni-Hard 4	
0.9640		GX300CrMoNi1521	-	-	-	-	-	-		F45005			
0.9650		GX260Cr27	-	Grade 3 D	-	-	0466	-					
0.9655		GX300CrNiMo271	-	Grade 3 E	-	-	-	-			20C 25N20S2		
1.4841	SUH 310	X15CrNiSi25-20	310	314S31	X 15 CrNiSi 25 20	Z15CNS25-20	-	-		S31400		Cronifer 2520	

H		VDI 3323 41	Material Description Hardened cast iron				Composition / Structure / Heat Treatment Hardened					HB 550	HRc 55
Mat'l No.	JIS	DIN	AISI/ASTM/SAE	BS	EN	AFNOR	SS	UNI	UNE / IHA	UNS	GOST	Brands	
0.9635		GX300 CrMo 15 3	-	-	-	-	-	-					
0.9645		GX260 CrMoNi 20 21	-	-	-	-	-	-		F45007			

EDP No.	Page
E2410	686
E2429	687
E2461	716
E2462	716
E2463	716
E2464	696~697
E2492	684
E2498	810~811
E2509	698
E2510	695
E2512	685
E2516	702~703
E2524	719
E2535	683
E2551	707
E2552	708
E2553	704~705
E2554	706
E2570	690~692
E2571	693~694
E2572	699
E2573	700~701
E2574	709
E2575	709
E2576	712
E2577	712
E2595	710
E2596	711
E2597	713
E2598	714
E2606	718
E2675	805
E2676	806
E2677	807
E2678	808
E2679	809
E2751	727~728
E2752	729~730
E2753	720
E2754	736
E2755	725
E2756	726
E2757	722
E2761	717
E2762	721
E2764	723
E2765	724
E2766	734
E2767	735
E2768	737
E2776	715
E2777	732
E2778	731
E2779	733
E2SET553	705
E3462	682
E3570	680
E3574	681
E5521	487
E5522	487
E5711	490
E5742	490

EDP No.	Page
E5908	481
E5909	482
E5910	480
E5930	483
E5E39	491
E5E40	491
E5E47	485
E5E48	486
E5E49	488
E5E50	489
E5E51	484
E5H22	472
E5H23	473
E5H24	466~468
E5H25	469~471
E9410	678
E9720	679
E9936	642
E9938	646
E9940	640
E9941	648
E9942	644
E9A26	650
E9A29	643
E9A30	645
E9A31	647
E9A32	641
E9A33	651
E9A34	652
E9A35	649
E9E43	653
EE515	420
EH830	418
EH831	422
EH840	418
EH841	422
EH852	421
EH862	421
EH911	414~415
EH912	414~415
EH913	416~417
EH914	416~417
EH915	419
EH916	419
EH917	423
EH918	423
EH919	424
EH920	424
EH921	425
EH942	425
EHE54	405
EHE55	405
EI450	507
EI451	506
EI880	505
EI881	509
EI996	510~511
EI997	502~503
EIA13	513
EIA14	514
EIB04	516
EIB86	512

EDP No.	Page
EIB87	508
EIB88	515
EIB93	504
EL612	689
EL623	688
EMB72	457
EMB73	457
EP922	492
EP923	492
EP924	493
EP925	493
ESB94	51
ESD02	52
G8A01	135
G8A02	136
G8A28	112~113
G8A36	123~124
G8A37	128
G8A38	114
G8A39	130
G8A45	131~134
G8A46	107~110
G8A47	127
G8A50	126
G8A52	125
G8A53	115
G8A54	111
G8A59	116
G8A60	118~122
G8B08	129
G8B54	106
G8B59	105
G8D62	117
G8D63	137
G8D64	138
G9400	596
G9410	575~576
G9424	563
G9425	578
G9432	586
G9433	582
G9437	550
G9438	551
G9439	580
G9444	566
G9445	568~569
G9447	584
G9448	589
G9449	591
G9452	571
G9453	593
G9454	552
G9455	553
G9527	567
G9528	581
G9540	590
G9553	575~576
G9624	548
G9634	556
G9A42	595
G9A68	565
G9A69	588

EDP No.	Page
G9A70	549
G9B80	572~574
G9B81	554~555
G9B82	557~558
G9B83	559
G9B84	560~561
G9B85	562
G9D67	273
G9D68	273
G9D69	274
G9D75	273
G9D76	273
G9D77	274
G9F45	594
G9F46	594
G9G44	564
G9G45	570
G9G46	577
G9G47	579
G9G48	583
G9G49	585
G9G50	587
G9G51	592
GA936	642
GA938	646
GA940	640
GA941	648
GA942	644
GAA26	650
GAA29	643
GAA30	645
GAA31	647
GAA32	641
GAA33	651
GAA34	652
GAA35	649
GAE43	653
GAE53	275
GM810	361~362
GM811	367
GM812	369
GM813	351
GM814	371
GM815	355
GM817	368
GM818	356
GM819	360
GM834	370
GM839	359
GM876	350
GM883	363~365
GM886	352~353
GM895	366
GM8A1	357~358
GM902	354
GMF52	448
GMF53	448
GMF54	443
GMF55	443
GMF56	449
GMF57	449
GMF58	444

EDP No.	Page
GMF59	444
GMF60	450~451
GMF61	450~451
GMF62	445~447
GMF63	445~447
GMG12	455
GMG13	455
GMG14	456
GMG15	456
GMG16	452
GMG17	452
GMG18	453~454
GMG19	453~454
GMG24	403
GMG25	403
GMG26	404
GMG27	404
GMG28	400
GMG29	400
GMG30	401~402
GMG31	401~402
GMG40	398~399
GMG41	398~399
GMG55	442
GMG56	442
GUF39	523
GUF40	522
GYF94	625
GYF95	624
GYF96	621
GYF97	618
GYF98	626
GYF99	619
GYG01	620
GYG02	623
GYG03	627
GYG52	622
GYG72	619
GYG74	621
GYG76	623
GYG77	618
JAH22	472
JAH23	473
JAH24	466~468
JAH25	469~471
ML012	792
ML022	792
ML032	793
ML042	793
ML062	794~795
ML072	796
ML092	797~798
ML102	799~804
ML112	792
ML122	792
ML132	793
ML142	793
ML162	794~795
ML172	796
ML212	792
ML222	792
ML232	793

EDP No.	Page
ML242	793
ML262	794~795
ML272	796
RTI104	527
SEM845	245~253
SEM846	172~181
SEM846	182~184
SEMD98	166~171
SEMD99	185~192
SEME01	212~218
SEME35	234~238
SEME36	254~255
SEME61	193~211
SEME64	219~233
SEME70	239~244
SEME71	256~259
SEME72	260~265
SEME73	266~270
SEME75	271~272
SGED27	532~533
SGED28	531
SGED29	534~535
SGED30	537~538
SGED31	536
XMB110A	58
XMB110D	59
XMB120C	58
XMB130A	59
XMB260T	58
XMF110V	65~69
XMM110V	59
XMR110A	60~64
XMR110D	65~69
XMR120C	60~64
XMR260T	60~64
XSEMD98	84
XSEME01	87~88
XSEME36	90
XSEME59	85
XSEME60	86
XSEME68	89
XSEME75	91
ZBC	70
ZBS	71
ZBT	72
ZMC	92
ZMS	93
ZMT	94
ZRC	73
ZRS	74
ZRT	74



Global Cutting Tool Leader **YG-1**



MILLING

HIGH QUALITY PRODUCTS and ON TIME DELIVERY for WORLD-WIDE CUSTOMERS

Since 1982, YG-1 has been committed to quality, innovation and the unique customer experience.

Our performance and experience have granted YG-1 the global impression of one of the leading manufacturers of high quality cutting tool solutions. This global footprint expands over 75 countries, with international logistic centers, pledging to our customers to give the best service available today - and tomorrow.

EUROPE

 BELGIUM	 FINLAND	 ITALY	 PORTUGAL	 SLOVENIA	 THE NETHERLANDS
 CROATIA	 FRANCE	 LITHUANIA	 ROMANIA	 SPAIN	 TURKEY
 CZECH REPUBLIC	 GERMANY	 NORWAY	 RUSSIA	 SWEDEN	 UNITED KINGDOM
 DENMARK	 HUNGARY	 POLAND	 SERBIA	 SWITZERLAND	

ASIA PACIFIC

 AUSTRALIA	 INDONESIA	 MALAYSIA	 SINGAPORE	 UNITED ARAB EMIRATES
 CHINA	 ISRAEL	 PAKISTAN	 SOUTH KOREA	 VIETNAM
 HONG KONG	 JAPAN	 PHILIPPINES	 TAIWAN	
 INDIA	 KINGDOM OF SAUDI ARABIA		 THAILAND	

AMERICAS

 BRAZIL	 CANADA	 COLOMBIA	 MEXICO	 UNITED STATES
--	--	--	--	---

AFRICA

 EGYPT	 SOUTH AFRICA
---	--



HEAD OFFICE

211, Sewolcheon-ro, Bupyeong-gu, Incheon, South Korea

Phone: +82-32-526-0909

Http://www.yg1.kr E-mail: yg1@yg1.kr

Note The information is provided for reference only. Tool specifications are subject to change without prior notice.
Although we endeavor to supply accurate and timely information, there can be no guarantee to cover every particular application.
YG-1 or publishers are not liable for any damage for use of the information.



Search 'YG-1' on social media outlets